

**PACKAGE INCLUDES**

- DROPPER POST
- PUGET 1X LEVER
- HINGED CLAMP
- LEVER BOLT
- SHIFTER CABLE
- CRIMPABLE CABLE END
- HOUSING ENDS
- CABLE HOUSING
- SHIFTER CABLE END BARREL ADAPTER.

**WARNING:** DO NOT DRILL OR MODIFY YOUR FRAME IN ANY WAY. DOING SO WILL VOID THE WARRANTY. MODIFICATION OF YOUR FRAME IN ANY WAY MAY RESULT IN FRAME FAILURE WHICH MAY RESULT IN SERIOUS INJURY OR DEATH.

**TOOLS NEEDED**

- 3MM, 4MM, AND 5MM ALLEN WRENCHES
- CABLE CUTTERS
- HIGH PRESSURE SHOCK PUMP

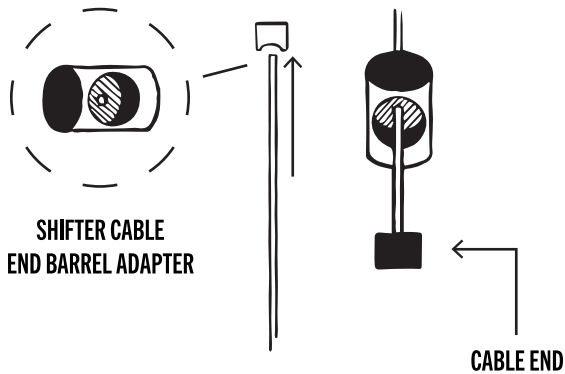
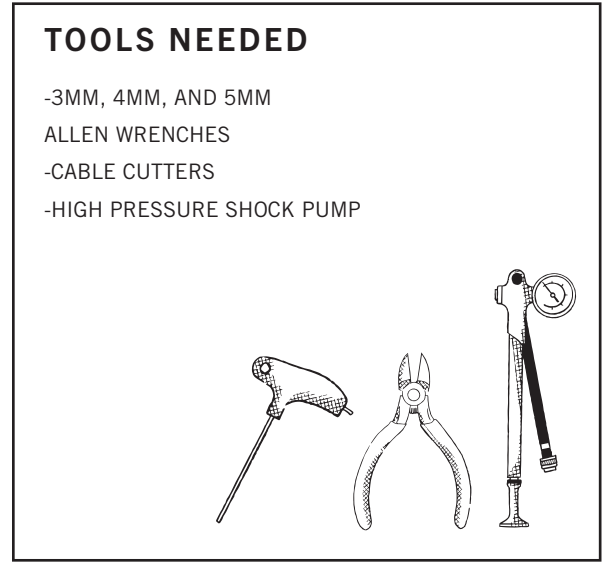
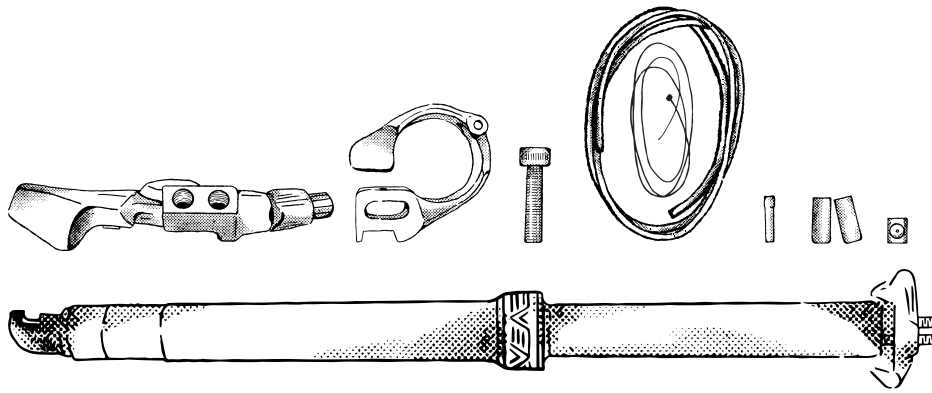

**STEP 1**

INSERT CABLE INTO SHIFTER CABLE END BARREL ADAPTER.

**STEP 2**

INSERT CABLE WITH BARREL ADAPTER INTO DROPPER POST ACTUATOR ROD.

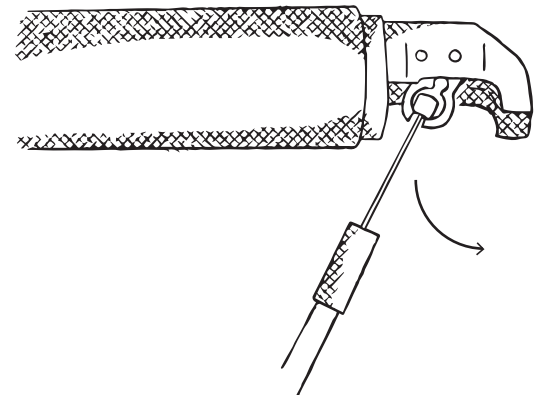

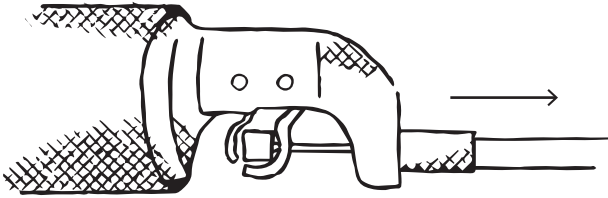

## STEP 3

PULL ACTUATOR ROD AND INSERT CABLE THROUGH SLOT.  
SET CABLE HOUSING INTO THE BOTTOM HOUSING HOLDER.

## STEP 4

INTERNALLY ROUTE CABLE HOUSING THROUGH FRAME  
ACCORDING TO MANUFACTURER'S RECOMMENDATIONS.

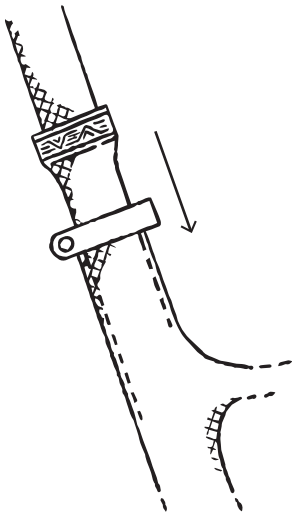
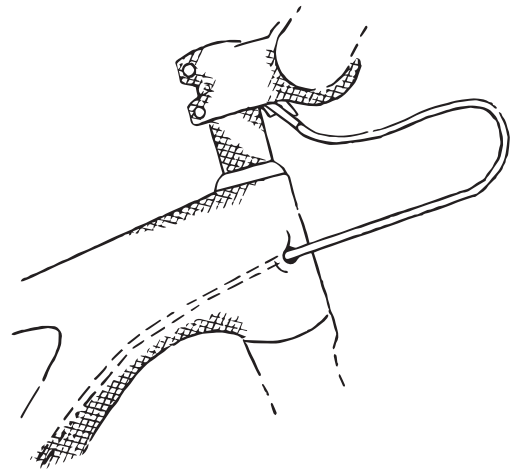

## STEP 5

INSERT THE DROPPER POST INTO PROPERLY LUBRICATED  
SEAT TUBE. BE SURE TO INSERT POST BEYOND MINIMUM  
INSERTION LINE ON POST.

## STEP 6

TIGHTEN SEAT TUBE CLAMP TO THE RECOMMENDED TORQUE SPECIFICATIONS OF YOUR MANUFACTURER.

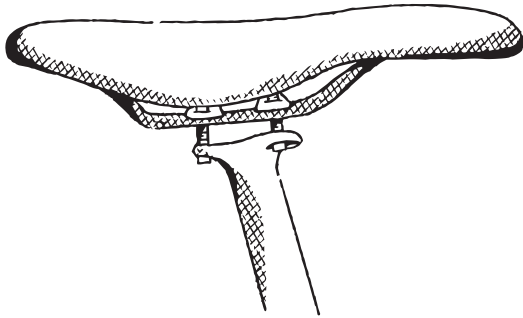
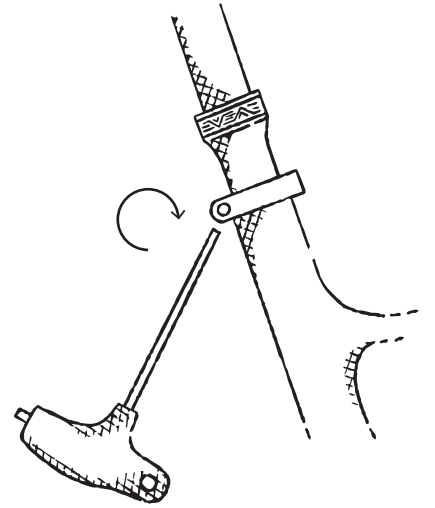

## STEP 7

PLACE SADDLE RAILS INTO CLAMP, ADJUST ANGLE AND FORE/AFT POSITION PER BIKE FIT, TIGHTEN BOLTS WITH 5MM ALLEN WRENCH TO 8-10NM.

## PUGET 1X LEVER INSTALL

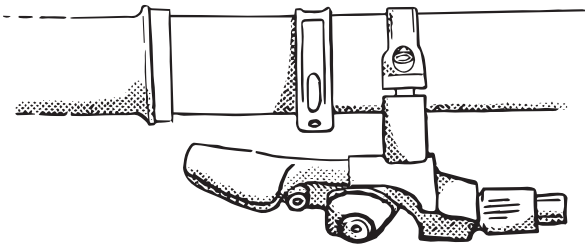

## STEP 1

POSITION HINGED CLAMP ON BAR AND ATTACH LEVER TO CLAMP USING EITHER THREADED HOLE ON LEVER BODY TO BEST FIT YOUR HAND. TIGHTEN WITH 4MM ALLEN WRENCH TO MAXIMUM 4NM. NOTE: THIS POSITION CAN BE CHANGED AFTER INSTALL TO FINE TUNE FIT.

## STEP 2

LOOSEN BUT DO NOT REMOVE THE CABLE FIXING BOLT ON THE UNDERSIDE OF THE DROPPER LEVER WITH A 3MM ALLEN WRENCH, SCREW THE BARREL ADJUSTER FULLY IN CLOCKWISE, AND MAKE SURE THE CABLE HOUSING HAS A HOUSING END INSTALLED. INSERT THE DROPPER CABLE THROUGH THE BARREL ADJUSTER UNTIL THE HOUSING IS COMPLETED SEATED IN BARREL ADJUSTER, THREADING THE CABLE UNDER THE CABLE FIXING BOLT AND WASHER.

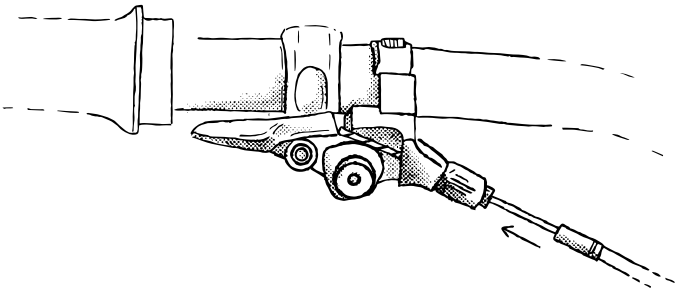

## STEP 3

PULL CABLE TAUT AND TIGHTEN CABLE FIXING BOLT TO 2NM WITH A 3MM ALLEN WRENCH.

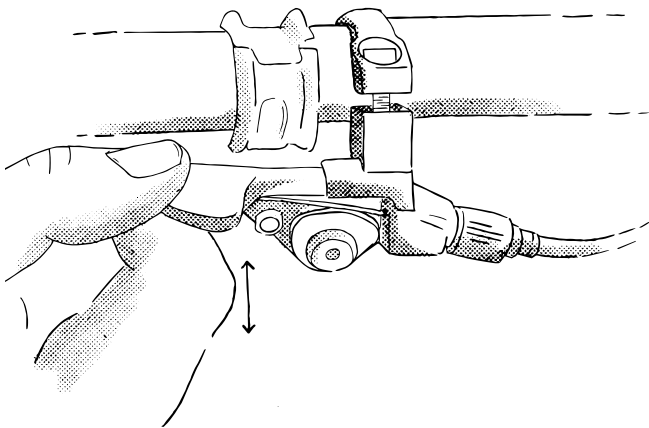
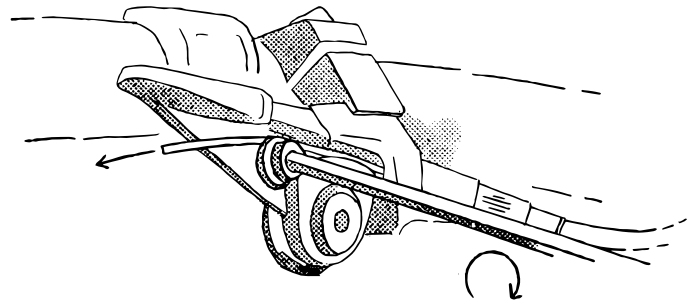

## STEP 4

PUSH THE LEVER 5-10 TIMES TO MAKE SURE THE CABLE HOUSING IS FULLY SEATED AND TO CHECK FOR PLAY IN THE CABLE. NOTE: IF THERE IS PLAY IN THE LEVER/CABLE, LOOSEN CABLE FIXING BOLT WITH 3MM ALLEN WRENCH AND PULL CABLE TIGHT A SECOND TIME. FOR MICRO ADJUSTMENT, USE THE BARREL ADJUST ON THE LEVER WHERE THE CABLE ENTERS.

## STEP 5

TRIM EXCESS CABLE WITH CABLE CUTTERS WITH ENOUGH ROOM TO PLACE CABLE END, APPROXIMATELY 10MM. IT IS IMPORTANT TO USE PROPER CABLE CUTTERS TO PREVENT THE CABLE FROM FRAYING.

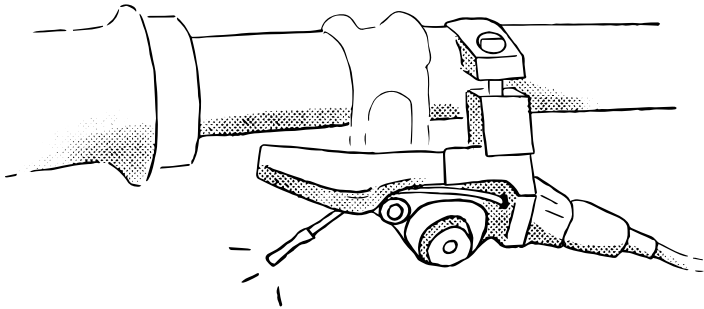
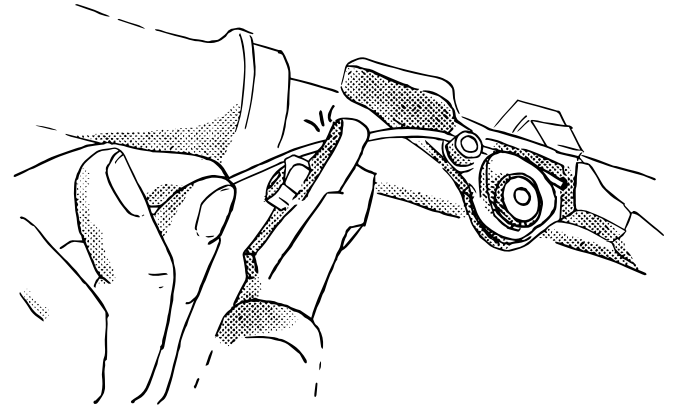

## STEP 6

CRIMP CABLE END IN PLACE.  
PUSH LEVER.  
DROP POST.  
GET RAD.

