

JAVA TECHNICAL SPECIFICATIONS



2023 Version 1.7



JAVA SPECIFICATIONS CONTENTS

To go to required section click [coloured headings](#) below

Section 1		Battens	12
Introduction	3	Buildout	13
Specifications	4		
Colours	6		
Section 2		Section 4	
Installation Styles	7	Panel details	14
Full Height		Stiles	
Cafe Style		Rails	
Tier on Tier		Mid-rail	15
Tracked Shutters		Top & Bottom Rail Sizes	
Unsupported Shutters		Louvres	16
		Louvre pin	
		Tilt Rods	
		Standard tilt rod	
		Silent tilt rod	
		Offset tilt rod	
		Offset tilt rod for Multi-fold Shutters	
Section 3		Section 5	
Frame styles	8	Hardware	17
Beaded		Hoffman Keys	
Insert L		Panel Weight	18
Plain Deep L		Fixed Louvre Options	
Tiara Z			
Crown Z	9		
Bullnose Z			
Bullnose Z Deep			
Camber Deco			
Hang Strip	10		
Cover Strip			
Corner Posts		Section 6	
Deco		Sizing & Measuring	19
L/Z		Order Size Definition	
Bay Posts		Overall Panel size (OP)	
L/Z		Overall Dimension of frame (OD)	
Deco		Tolerances	20
T-Posts		Mounting Type	
Deco	11		
L/Z		Section 7	
T-post Connector		Warranty, EDR & Cancellations	21
		Terms & Conditions	22

1. JAVA INTRODUCTION

The Java range is manufactured from ABS (a hard, lightweight plastic) and is ideally suited to bathrooms and wet rooms or rooms that have condensation or humidity issues as it is 100% waterproof.

Aesthetics:

Extremely hardwearing and waterproof the Java shutter is also suitable for high traffic areas and is often used in commercial installations.

ABS is a hardwearing and lightweight plastic that is easily moulded. This means that unlike lesser vinyl products in the market the profiles of the frames are far more refined. In addition ABS is far more robust than vinyl ensuring that it will cope far better in daily use.

Frames and Panels:

Limited range of frames available.

Stiles:

Please note the stiles are manufactured in a beaded stile or flat stile.

Louvres:

Java is available in 47mm, 63mm, 76mm, 89mm, 114mm elliptical louvres.

Special Shapes:

Special shapes are available to order in Java.

Colour palette:

There are 12 standard colours available; custom colour (excluding black) is available at a surcharge.

Shutter Range	Finish	Louvre Material	Stile Material	Rail Material	Frame Material
Java	Solid Paint	ABS	ABS	ABS	ABS

JAVA SPECIFICATIONS

PANEL SIZE LIMITATIONS

Panel structure

The S:CRAFT shutter panel is made up of several parts. To help you understand the panel construction please see photograph.

MOUSE HOLE

STILE

TILT ROD

LOUVRE

RAIL

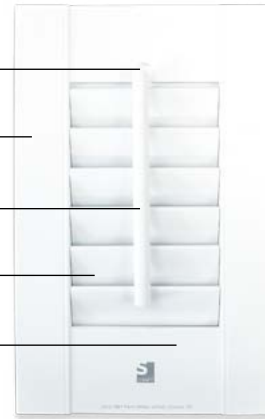

Louvre Size	Width			Height			
	Minimum	Maximum		Maximum number of untracked Bi-fold panels	Minimum	Maximum with mid rail	Maximum without mid rail
		Single hung	Bi-fold hinged shutter/ Multi-fold with Top and Bottom track				
47mm	152mm	550mm	550mm	2	250mm	3000mm	H>1828.8mm
63mm	152mm	800mm	610mm	2	250mm	3000mm	H>1828.8mm
76mm	152mm	800mm		2	250mm	3000mm	H>1828.8mm
89mm	152mm	890mm		2	250mm	3000mm	H>1828.8mm
114mm	152mm	890mm		2	250mm	3000mm	H>1828.8mm

NB: Where the panel size limits above are exceeded, warranty on the order line is waived automatically.

NB: When a single hung panel width is less than 228.6mm and used with the following frames: Deco, L, Z and Hang Strip, the stile opposite to the hinge will be rebated.

If panel height is over 1828mm, a Mid Rail is required and if the panel has a Mid Rail but the height from the centre of the Mid Rail to the top of the top rail or to the bottom of bottom rail is still over 1828mm, another Mid Rail will be required.

If you do not specify the Mid Rail location, the order will be held to confirm if a Mid Rail is required. However, if you specify no Mid Rail, you will waive your warranty and manufacture will proceed as per your instructions.

Shutter used for door without bottom support:

In situations where shutters are used for door applications, which do not have any support underneath the panels, the customers must inform S:CRAFT when placing this type of order.

- 1). Shutters with bottom gap over 2.54mm;
- 2). Shutters with no frame or no existing sill at the bottom to support the panel (or the shutter has bottom frame/existing sill, but the panel is frequently left in the open position without bottom support). In situations when shutters are used for door application, the customers must order "Used as Door" when you placing this type of order.

Please note:

- (1) The factory will add extra hinges to support the panels.
- (2) Bigger and Stronger Top and Bottom rails will be added to reduce the probability of the panels sagging and increase shutter intensity.
- (3) If customers fail to notify S:CRAFT that the shutter will be used in door applications, the customers will be responsible for the cost of the any re-order that is submitted.

Please see the following chart for details.

Panel Configuration	
L,R,LR	LL, RR, LLRR
Manufactured with warranty waived	Must order it with track, we will not process it even with warranty waived

SPECIFICATIONS

Material	Acrylonitrile Butadiene Styrene (ABS)
Panel Weight	14.69kg M ² *
Paint Colours	12
Stain Colours	✗
Custom Colours available (solid colours only)	✓
Louvre sizes	47mm 63mm 76mm 89mm 114mm
Max single panel width	500mm : 47mm 800mm : 63mm 800mm : 76mm 890mm : 89mm 890mm : 114mm
Max multi panels width	550mm 47mm 610mm : REST
Max number of panels hinged together	2
Max and min panel heights. (For panel height over 2500mm, it is suggested using 50.8mm or 57mm stile to aid structural integrity).	3000mm 250mm
Solid Panels available	✗
Special shapes	✓
Custom Bay Post angles	✓
Stile Type	Beaded or Flat
Fixed Louvres	✓

* Average Weight













COLOURS

Please note. Colours may vary slightly between dye lots. Shutters for the same installation should be ordered together to avoid variations in colour. Colours may vary slightly from colour samples. For this reason, colour samples should be updated annually.

PAINT

Please note that all colours for Java ABS range are finished in an oil-based paint.

COLOUR OPTIONS

JAVA PAINT OPTIONS (12 COLOURS + CUSTOM COLOUR WITH SURCHARGE)			
Colour ID	Colour Name		Hinge Colour
001	Pure White		1. Stainless Steel
002	Extra White		
003	Silk White		
004	Bright White		
006	Pearl		
009	Creamy		
032	Sea Mist		
049	Stone Grey		
053	Clay		
063	Decorator's White		
076	Aura White		
080	Taupe Grey		

Custom colours are also available at a surcharge.

Please note black (including 836 Classic Black) is **not available** to order in Java.

Due to the nature of material manufacturing, colours may vary slightly between dye lots. Please order shutters for the same home at the same time. Slight variations may also occur between the finished products and the colour swatches you use.

2. INSTALLATION STYLES



FULL HEIGHT

Shutter covering the full height of aperture.



TRACKED SHUTTERS

Bi-Fold

Shutters suspended from a top track hinged together in a bi-fold configuration to allow them to be folded back to the end of the track at 90° or 180°. Suitable for use with patio doors, wardrobes or as a room divider. May be specified and fitted with or without side frames.

By-Pass

Shutters suspended from a top track. Panels slide behind or in front of one another to open or close. Suitable for use with patio doors, room dividers and wardrobes. May be specified and fitted with or without side frames.

* Refer to the separate track specifications for further details.



CAFE STYLE

Shutter covering only the lower portion of aperture providing privacy and light control but leaving the top portion un-shuttered to maximise light, where privacy is not required.



SHUTTERS USED AS DOORS

In situations where shutters will be used for a door application which does not have support underneath the panels, the customer must inform S:CRAFT when placing the order.



ROOF SHUTTERS

Would not be supplied or covered under warranty.

Please refer to Fiji specifications for roof details.

Panel Configuration

L, R, LR	LL, RR, LLRR
Manufactured with warranty waived	Only available with a tracked installation. Not covered by warranty.



TIER ON TIER

Shutter is split into two halves so the top and bottom panels can be independently operated / opened fully. The standard gap between top tier and bottom tier is 2.5mm. For bi-fold tier on tier shutters only, 3 or less bi-fold panels are within warranty.

Please note:

1. The factory will add extra hinges to support the panels
2. The factory will add a larger and stronger top and bottom rail. This will reduce the risk of panels sagging.

N.B Customers will be responsible for any EDR re-order where there has been a failure to notify S:CRAFT that the original shutter order was for a door application.

3. FRAMING STYLES

BEADED

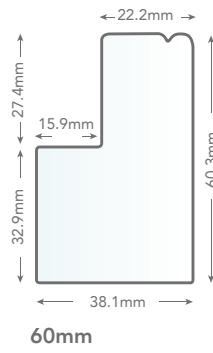
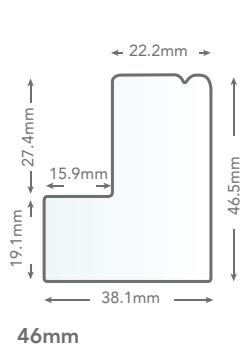

INSERT L

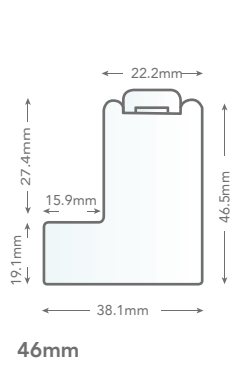

INSERT L

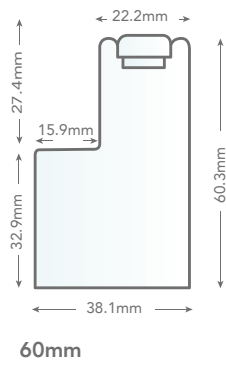

DEEP PLAIN L

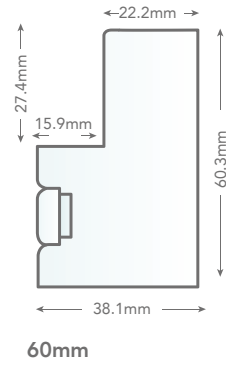

TIARA Z FRAME

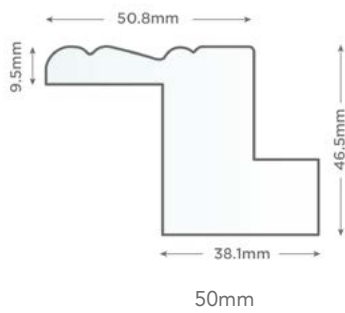

TIARA Z SILL PLATE

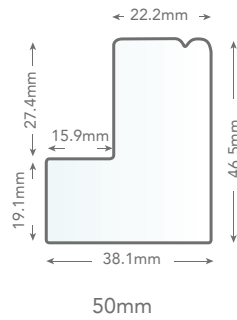

CROWN Z FRAME

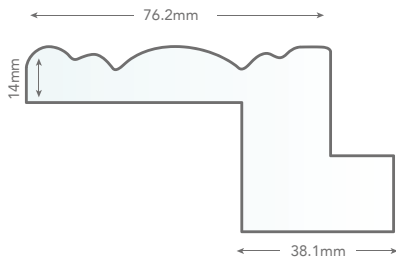

76mm

CROWN Z SILL PLATE

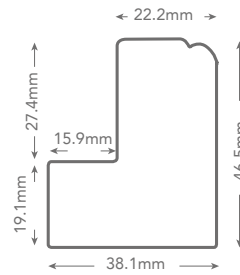

46mm

BULLNOSE Z

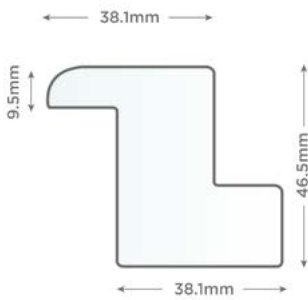

38mm

BULLNOSE Z SILL PLATE

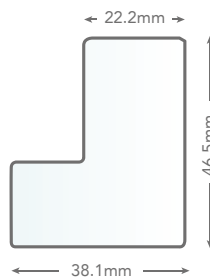

38mm

DEEP BULLNOSE Z

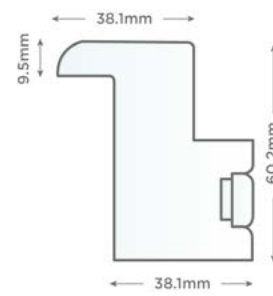

38mm

Please note:
the Deep Bullnose Z Frame uses the Deep Plain L Frame W/ Insert for the sill plate

CAMBER DECO FRAME*



50mm

CAMBER DECO SILL PLATE

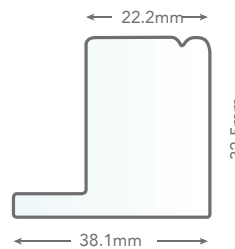

* Please note this has no inserts in Java

PRE-DRILL L FRAMES (INSIDE MOUNT ONLY) OR Z FRAMES

Please note that the predrilled hole and the plug will not be a 100% complete fit, but that would not affect the performance of the screw. Shutters can't be remade solely because of this issue.



©S:CRAFT Copyright in this material belongs to S:CRAFT and copying or reproduction in whole or in part is strictly prohibited. We reserve the right to alter specifications without prior notice.

HANG STRIP

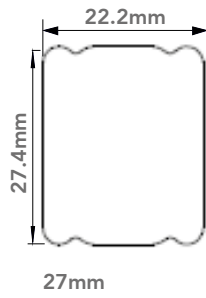

COVER STRIP*



COVER STRIP*

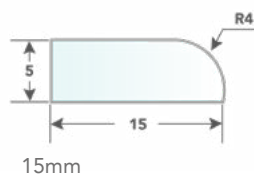

* Cover strips are made in wood.

CORNER POST

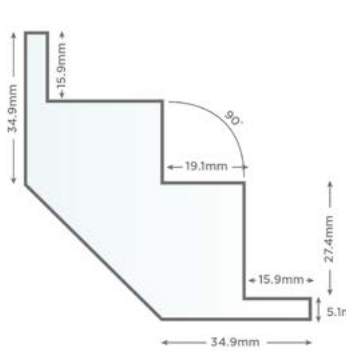

(Deco Frame)
32mm

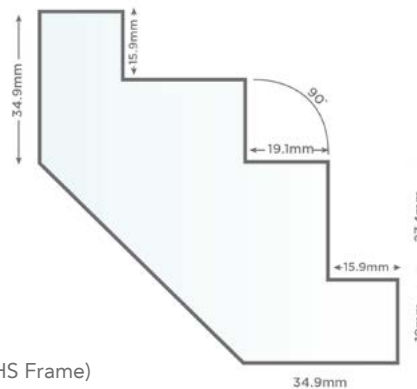

(L/Z/HS Frame)
46mm

BAY POSTS

Additional custom angles are also available in all materials.

135° angle

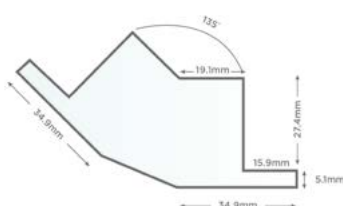

(Deco Frame)

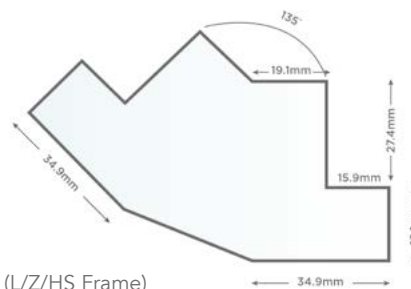

(L/Z/HS Frame)

T-POST

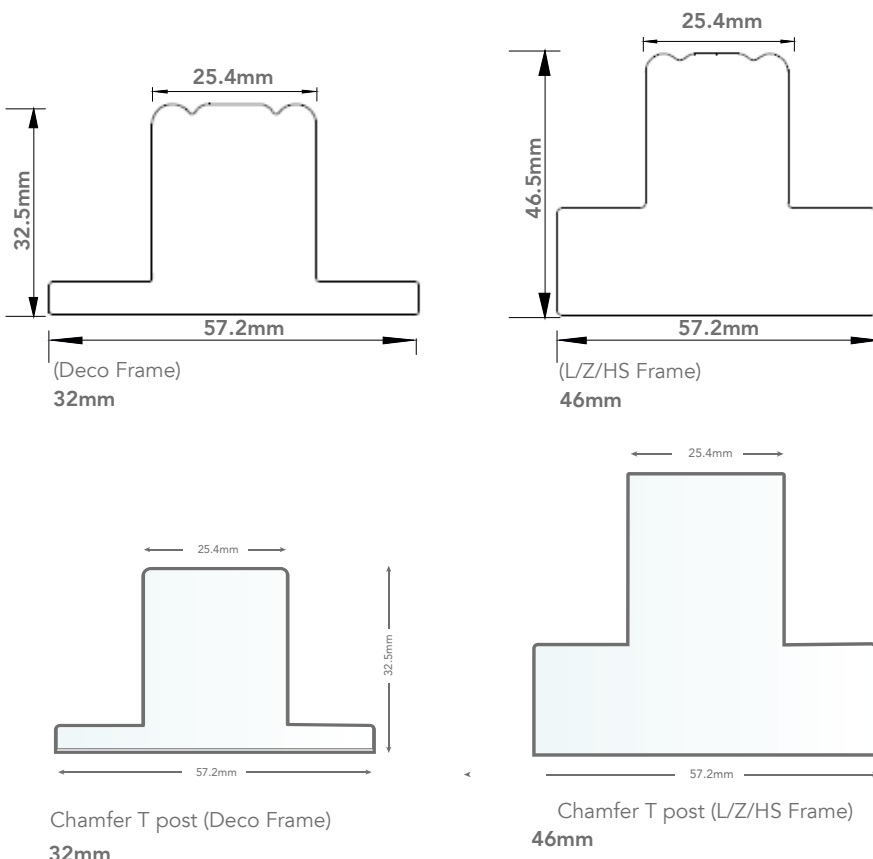

NB. Please note that horizontal T Posts over 1219mm are not covered by warranty.

NB. When ordering the panel configuration with a vertical T-post and only some of the panels have a top frame or a bottom frame, the T-post will extend to the top frame or bottom frame OD size by default.

NB. Please note that horizontal T-Posts over 1219mm are not covered by warranty. Only vertical T Posts are adjustable. When the customer requires all or some frames, there will be no predrilled hole by default.

T-POST CONNECTOR

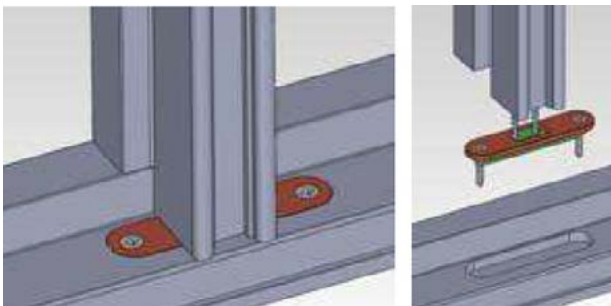

T-Post connectors are available for Antigua, Bermuda, Cuba, Java, Fiji and Samoa.

Available colors: Pure White, White, Pearl, Bisque, Black and Nickel-Plated.

Available for 25mm and 44mm face width T-Posts.

T-Post connectors can be used with the following frames and posts:

L FRAME

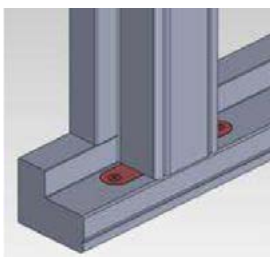

DECO FRAME

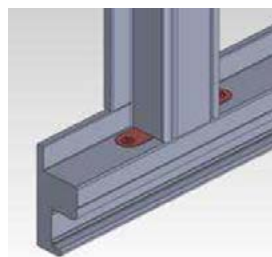

Z FRAME

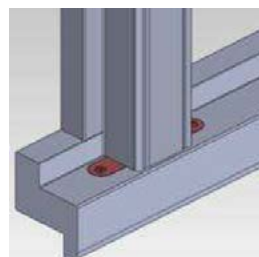

HANG STRIP (BESIDE)

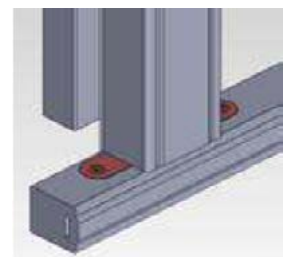

1. For Hang Strip, some special shape shutters and Horizontal T-Posts, the connector fixing is not supplied and T-Post will be installed by screws and dowels instead.

2. If there is a barrel bolt or sleeve & base plate (Java) which may interfere with the T-Post connector, all the T-Posts for the entire shutter will be installed with screws and the frames will be pre-drilled.

3. The screw colour will match with that of the T-Post connector colour, except Java which will be stainless steel screws.

Frames split when the frames length exceed the below limitation.

When frame lengths (including shutter frames, batten, fascia, header and tracks for track system) exceed the below limitation, then the frames will be split as the below chart describes. Please review the chart for reference.

Shipping Method	Program	Frame Length (L) (mm)
Standard shipping	all programs	3630<L≤7260 (2 sections)/ L>7260 (3 sections)
Airfreight	all programs	3048<L≤6096 (2 sections)/ 6096<L≤9144 (3 sections)

BATTENS

Battens can be butt-joined as per the drawings below:



Standard sizes:

Stock Battens are available in the following sizes in all materials

- | | |
|--------------|--------------|
| 2.5mm x 27mm | 5mm x 45mm |
| 3mm x 15mm | 5mm x 63.5mm |
| 3mm x 20mm | 25mm x 30mm |
| 3mm x 30mm | 25mm x 40mm |
| 3mm x 60mm | 30mm x 40mm |
| 5mm x 15mm | 40mm x 40mm |
| 5mm x 25mm | |

Minimum charge one linear meter per batten

Battens are made of ABS with a surcharge.

Battens and Panels identification: The S:CRAFT order number will be stamped on the bottom of each panel and one end of each corresponding batten to identify which one belongs to which item.

Build-out (Extension)

All buildout will be made of ABS at a surcharge.

- For L/Z/Deco/Hang Strip Frame including T-Post, we will pre-attach the build-out of which the thickness is less than 50.8mm (including 50.8mm) by default.
- For L/Z/Deco/Hang Strip Frame including T-Post, when build-out is over 50.8mm, we will supply build-out loose with holes pre-drilled; also note that for frame not able to pre-drill holes, such as Beaded L Frame, we will supply build-out loose without holes pre-drilled, either.
- For all frames, we will add build-out per the order form. E.g., if the frame type is 63mm Frame, and build-out is 10mm, we will use 63mm L Frame added with 10mm build-out instead of changing the frame type to 46.5mm L Frame added with 27mm build-out.
- Buildout for Z Frame: If you want the buildout to be added to the bottom of Z frame like the drawing below on the right, please ALWAYS specify in the special notes of the order form, "Add buildout on back of frame". The DEFAULT BUILDOUT will be the left drawing.

For bay/corner Post, we will supply build-out in every size pre-attached by default.

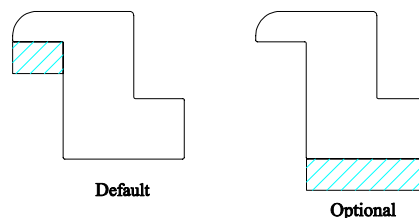

BUILDOUT

The default position for L/Z/Deco/Hang Strip frame with buildout are as follows:

1. L Frame with buildout, the default position is the back of the frame. Please see Beaded L frame 46mm as an example:

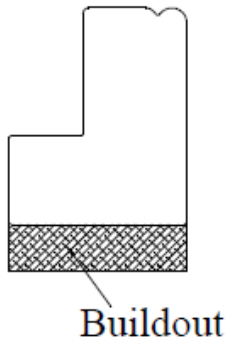

2. For the Z Frame with buildout, the default position is the back lip of the frame. Please see examples below:

Tiara Z Frame 50mm

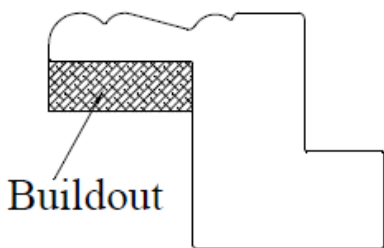

Crown Z Frame 76mm

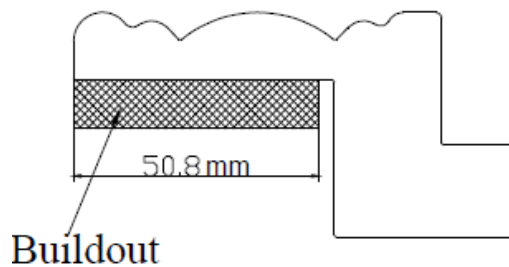

3. For the Deco Frame with buildout, the default is to have a full buildout positioned at the back of the frame. Please see example below of the Camber Deco Frame 50mm:



4. For the Hang Strip with Insert (beside the panel), the default is the back of the frame, as shown below on the 22mm Hang Strip with Insert:

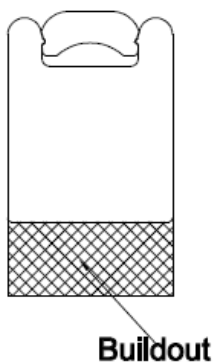

4. PANEL DETAILS

STILES

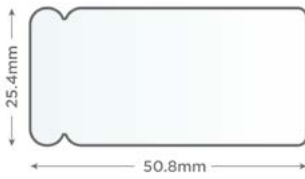

50.8mm Beaded Butt Stile

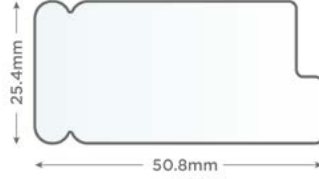

50.8mm Beaded Rebate Stile

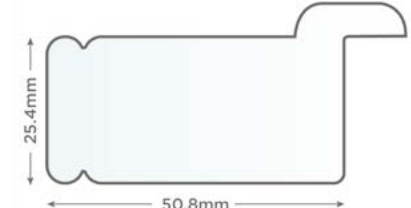

50.8mm Beaded D-Mould Stile

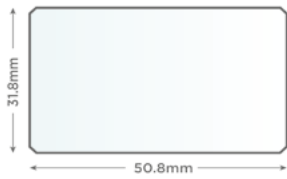

50.8mm Flat Butt Stile



50.8mm Flat Rebate Stile

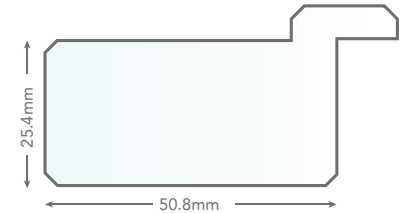

50.8mm Flat D-Mould Stile

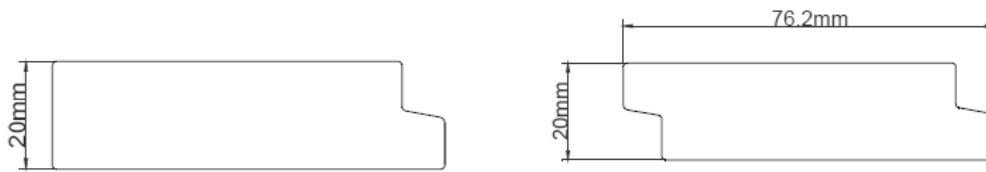

RAILS

By default the factory determines the rail size for each order, unless specified otherwise in the notes on the order form. Unless a mid-rail(s) is specified, top & bottom rails will be the same size. Rail sizes are normally larger than 80mm*. Different rail sizes can be requested though the combination of a fixed overall panel drop and louvre sizes means that it may not always be technically possible to fulfil every custom rail request.

S:CRAFT recommend ordering all shutters for one room at the same time in order to achieve matching rail sizes. Different windows that are side by side or within the same room must be identified and where rail size is important to the overall finish, dimensions must be specified.

*Generally the rail sizes will be larger than 80mm, but it does not mean that rail sizes bigger than 80mm are always with in warranty, the minimum rail size will differ from each order and depend on panel width, height and louvre size. Usually, the rail size will be supplied with in warranty, and only adjusted when the customer requests mid rails exact or specify the rail size. If rails are out of warranty then order will be placed on hold. Java rails larger than 4" in stain maybe supplied with joined rails.

STANDARD MID-RAILS

The standard Mid-Rail size is 76.2mm high. Different mid-rail sizes can be requested though the combination of a fixed overall panel drop and louvre sizes means that it may not always be technically possible to fulfil every custom rail request.

If the panel height is greater than 1828mm one or more mid-rails are required. If the height from the centre of the mid-rail to the top of the top rail or bottom of the bottom rail is 1828mm or more, then another mid-rail is required. Mid-rail positions should be specified at time of ordering. If the order specifies that a mid-rail is not required then all warranties on the order are automatically waived.

PLEASE NOTE: Normally, the maximum size a mid-rail can be made is 165.1mm, anything over 76.2mm will carry a surcharge.

MID-RAIL continued

Specified rail position is taken from the base of the shutter set to the centre point of the rail, except for solid based which is from the bottom to the top of the mid-rail.

The centre rail can deviate by + or - by the amount of millimetres shown below. If the mid-rail is to be exact with no deviation then this must be noted on the order under the notes when placing the order.

Louvre Size	Allowable +/- Deviation
47mm	19mm
63mm	25mm
76mm	31mm
89mm	38mm
114mm	51mm

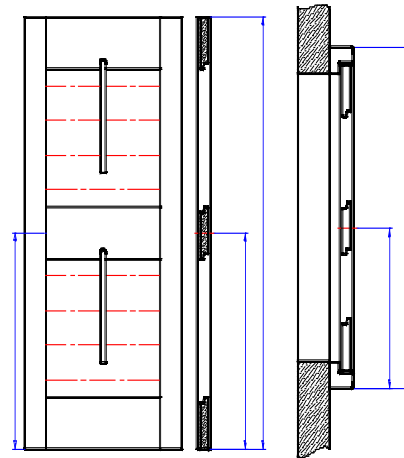

TOP & BOTTOM RAIL SIZES

Panel Height	Top & Bottom. Rail Minimum size	Top & Bot. Rail Maximum size			
		47mm louvre	63mm louvre	89mm louvre	114mm louvre
254mm~ 508mm	69.85mm	104.775mm	117.475mm	127mm	152.4mm
508mm~ 1143mm	76.2mm	104.775mm	117.475mm	127mm	152.4mm
1143mm~ 1625.6mm	85.725mm	165.1mm	165.1mm	165.1mm	165.1mm
1625.6mm~ 1981.2mm	92.075mm	165.1mm	165.1mm	165.1mm	165.1mm
>1981.2mm	111.125mm	165.1mm	165.1mm	165.1mm	165.1mm

LOUVRES

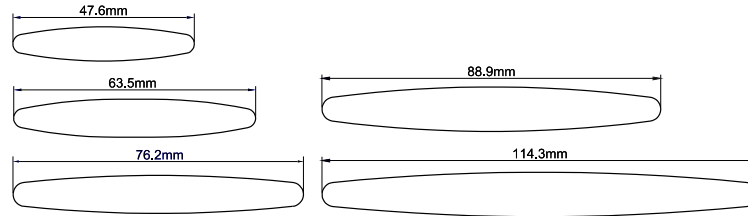

LOUVRE PIN

Louvre pins are used to ensure louvre tension. In addition a tension screw is inserted into one louvre in the panel. This is the same for all louvre sizes. Access holes are drilled in the in the stile for each panel to

allow the tightening or loosening of the tension screw, to adjust the louvre tension. Please note therefore additional holes will be visible in the stiles.

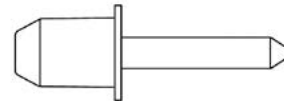

TILT RODS

Standard tilt rod

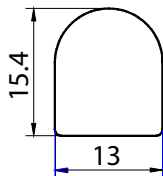

Silent tilt rod

Silent Tilt rods are integrated into the stile and are not visible. Silent tilt rods are available in 63mm, 76mm, 89mm and 114mm louvres. The 47mm does not have this option.

The Silent Tilt rod will automatically be split into 2 parts when the number of louvres connected to the silent tilt rod exceeds the following limit.

Louvre Size	Louvre Quantity	Panel height range
63mm	24	1289 - 1385mm
76mm	19	1276 - 1372mm
89mm	16	1289 - 1385mm
114mm	12	1289 - 1385mm

If the louvre quantity exceeds the above limit, the gear tilt control will be equally split into halves. If the louvre quantity is odd the bottom section will have one more louvres than the top section. If the panel has a divider rail, and the louvre quantity above divider rail or below divider rail exceeds the above limit, split tilt rods are also required.

Silent tilt is not available when the panel width is less than 220mm.

OFFSET TILT RODS

Offset tilt rods can be ordered. The standard offset is 25mm from the centre of the tilt rod to the end of louvre on hinge side. If a different offset is required please specify the position from the centre of the tilt rod to the end of the louvre on the hinge side in the short notes on the order form.

The centre of the tilt rod will be 25mm from louvre end on hinge side of the panel. For Fixed panels, the offset tilt rods will be positioned on the left side for all panels. For special shaped panels, the offset tilt rods will be on the higher side of the stile.

OFFSET TILT ROD FOR MULTI-FOLD SHUTTERS

Multi-fold panels will be made with the tilt rod offset from the centre to enable panels to be folded flat without tilt rods obstructing one another. The standard offset for the tilt rod is 7mm from the centre, i.e. tilt rod will be 7mm to the left of centre for left panels, and 7mm to the right of centre for right panels. Rebates between panels are made right over left. Bi-Fold panels (LR or LLRR) do not require offset tilt rods.

Specified Split Tilt location may be off by half a louvre space. Measure from bottom of bottom frame to the top of the louvre if order OD of frame, and from bottom of panel to the top of the louvre if order net panel size or overall panel size. Please note that the louvers are in close position when measured.

For 47mm louvre can be off by +/-19mm.
 For 63mm louvre can be off by +/-25mm.
 For 76mm louvre can be off by +/-32mm.
 For 89mm louvre can be off by +/-38mm.
 For 114mm louvre can be off by +/-51mm.

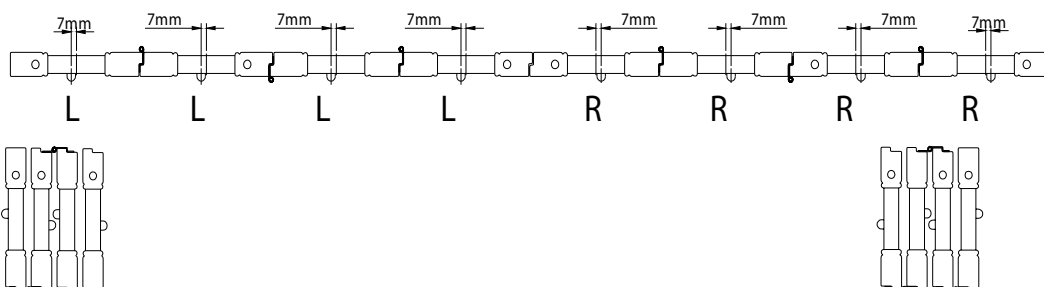

©S:CRAFT Copyright in this material belongs to S:CRAFT and copying or reproduction in whole or in part is strictly prohibited. We reserve the right to alter specifications without prior notice.

Hinges:

Rebate or Self-Mortice hinges are provided depending on the configuration. They are pre-mounted on panels and frames by two screws in the slotted holes. The screw for the third rest hole should be installed at installation. The hinge pins are removable.

Panel height	No. of hinges
<=1219mm	2
1219mm~1981mm	3
1981mm~2438mm	4
2438mm~3048mm	5
>3048mm	6

Hinge Colours
Stainless Steel (Surcharge) only.

Please Note:

End of hinge to top/bottom of panel is 50.8mm.

JAVA

Java program shutters, use a sleeve and base plate to replace the current magnet and magnet catch plate found in our other shutter programs, (Please refer to the pictures to the side).

You will see that the sleeve has a groove in the top for a screwdriver, this is so that you can adjust the tension of the sleeve.



Base Plate



Sleeve

HOFFMAN KEYS



These are supplied and are used to join frame corners together.



PANEL WEIGHT

Panel Weight		
Material	Louvre size	Weight (kg)/m ²
Java	47mm	14.69*
	63.5mm	
	76mm	
	88.9mm	
	114.3mm	

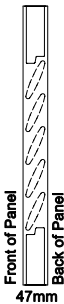
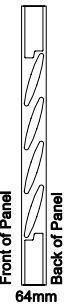
* Average Weight

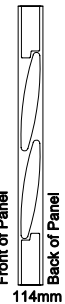
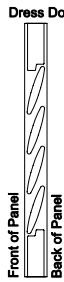
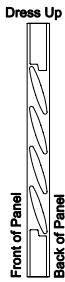
FIXED LOUVRE OPTIONS	
	Fixed Closed Position Fixed Open Position
<p>Available in two positions: closed or open at angle.</p>	    
<p>The standard default orientation for Fixed louvres is Closed 'Dress Down' with the bottom edge of louvres to the front of the panel. 'Dress Up' option is also available if specified on the order form.</p> <p>NB. Note that normal orientation for adjustable louvres when closed is in the 'Dress Up' state.</p>	<p>Dress Down Dress Up</p>  

NB: Fixed louvres closed Dress Down and fixed louvres opened as Dress Down are not available for specialty shutters with the exception of French Door Cutout Type A, B, C, and D without fixed louvres.

6. SIZING AND MEASURING

ORDER SIZE DEFINITION

Overall Panel size (OP):

The size given is the overall panel size. The width does not include the hinge space from panel to batten on the left & right side, but does include the gap between panels, the standard gap is 2mm between panels and we will calculate the single panel width based on this measurement (see diagram below). The height given must be net panel height. We will pre-mount the hinges and the magnets and include panel feet and L shape magnet catches in a hardware box. The stile can be Rebate or D-mould, please specify in the relevant section of the order form.

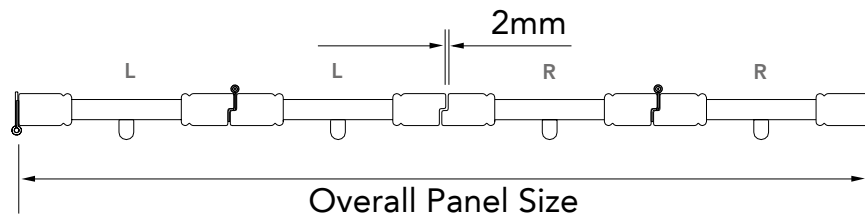

OD of frame:

Size given is "Outside Dimension" of the shutter; we will pre-mount the hinges and the magnets, and will include all the necessary hardware in a hardware box. The stiles can be Rebate and D-Mould stile, please specify on the order form.

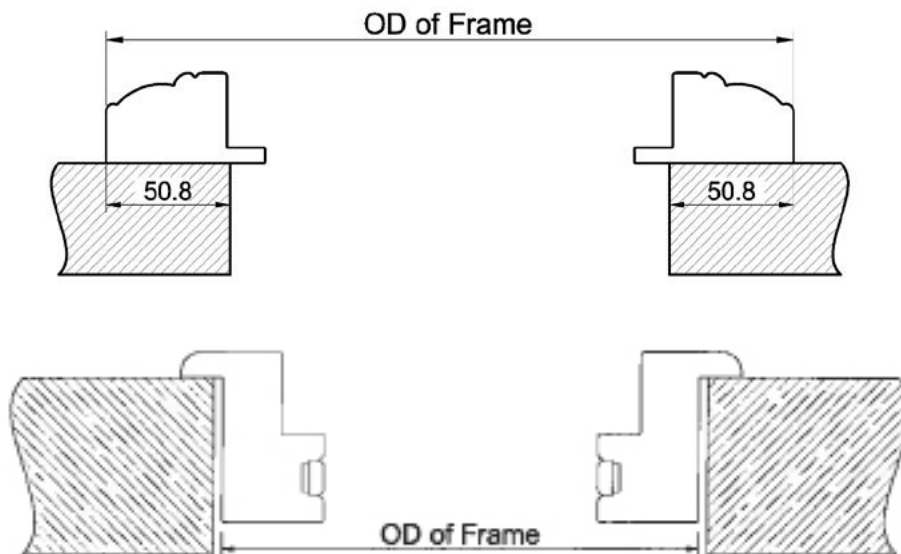

"Z" frame: Can only be ordered as inside mount, the size given must be OD of frame size. (Backside of Z frame, refer to the drawings).

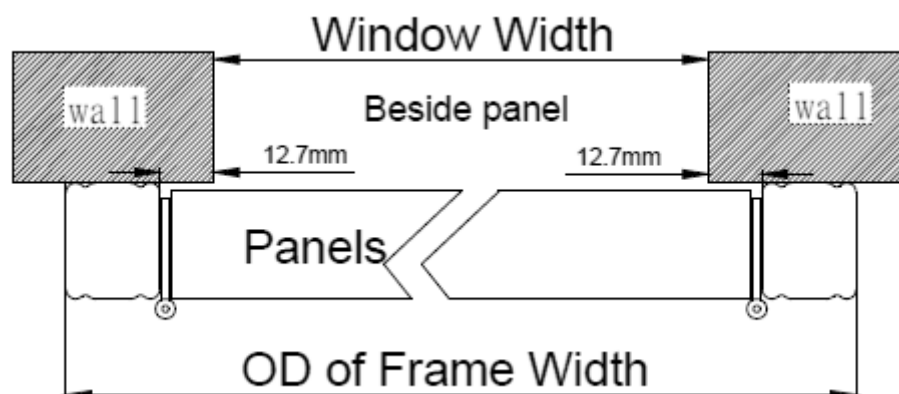

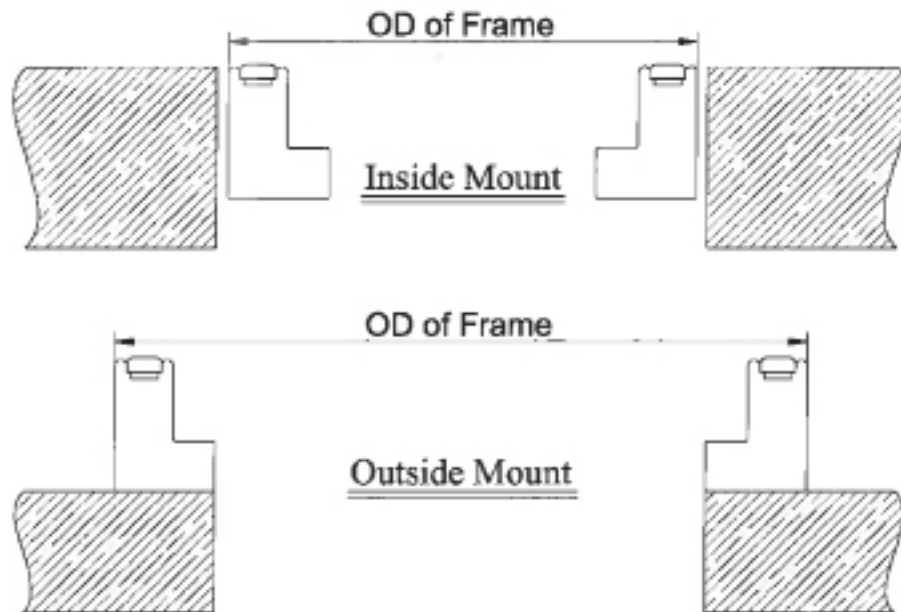

"L" frame: Can be ordered as inside mount and outside mount, size given must be OD of frame size.

TOLERANCES

Width: The width of the panel can be plus or minus 1.6mm from the order width.

Height: The height of the panels can be plus or minus 1.6mm from the order height.

Mid Rail location: Mid Rail location may be off by half a louvre space. Measure from bottom of bottom frame to centre of Mid Rail if order OD of frame, and from bottom of panel to centre of Mid Rail if order net panel size or overall panel size.

For 47mm louvre can be off by +/-19mm.

For 63mm louvre can be off by +/-25mm.

For 76mm louvre can be off by +/-31mm.

For 89mm louvre can be off by +/-38mm.

For 114 mm louvre can be off by +/-51mm.

MOUNTING TYPE

Café style shutter: Please specify on the order form if the shutter is a café style. We will finish the top of the panels and one end of the battens.

If a café shutter is required with a 3 sided frame, it should be 3 sides inverted.

***Tier on Tier:** The standard gap between the top tier and bottom tier is 2.5mm.

Full height: Regular shutters running the full height of a window.

* Please Note: For Tier on Tier shutters, whenever an upper or lower panel is larger than 1981.2mm, the factory will add one extra hinge, the top and bottom rails may be made larger for additional strength, this will reduce the number of louvres by one as long as the rail sizes remain within spec.

CLEANING RECOMMENDATIONS

Use a clean, dry feather duster, cloth or vacuum with a brush attachment to gently remove dust and debris. To ensure thorough cleaning, wipe the louvres in the open and closed positions. Do not immerse the product in water or use abrasive chemical solvents. This may cause discolouration and the wood to warp. Ultrasonic cleaning is not recommended. For best results on Antigua shutters use a cotton cloth dampened with water. Polyester cloths tend to create static, which can attract dust.

7. WARRANTY, EDR & CANCELLATIONS

WARRANTY

S:CRAFT warrant that our shutters will be free from defects in materials or workmanship for as long as the original purchaser owns the shutters provided that such products were properly installed; and such products were made or assembled exclusively from original materials and components. Any resale or other transfer of the product and/or materials voids this warranty.

This warranty is exclusive and in lieu of all other obligations, liabilities or warranties. In no event shall S:CRAFT be liable for incidental or consequential damages, or for any expense associated with such damages. Repair or remakes of defective products is the sole remedy under this warranty and in no event shall S:CRAFT be liable for costs to remove and/or reinstall the product. Repairs will be made only with like or similar parts. This warranty does not include shipping charges or the cost of labour involved for measuring and installation.

This warranty does not cover any condition of or damage to the shutter or window, from unauthorised repairs, accidents, alterations, misuse, abuse, act of God, motorized devices, wear and tear or failure to follow our instructions with respect to measurement, installations, cleaning or maintenance. Improper, inappropriate, or unauthorised replacement parts, repairs or maintenance voids this warranty. This warranty excludes all liability for removal of the shutter and reinstallation in the same or another window, or damage to the window frame, glass or any other portion of the window. Due to natural variations in colour, grain and texture of the raw materials S:CRAFT is not able to guarantee exact matches on subsequent orders. Returns cannot be authorized due to these normal variations.

All other warranties, both express and implied, are expressly disclaimed. This warranty excludes all liability for consequential or incidental damages for any cause whatsoever.

Colour Fastness:	3 years
Structure:	3 years
Hardware:	1 year
Stainless Steel Hardware:	3 years

MODIFICATIONS AND CANCELLATIONS

Since our products are made to measure based on specifications supplied by customers on our original order form, no cancellations can be accepted. Once an order is submitted, customers are liable for the full value of the order.

Product changes will only be allowed prior to production. This is usually within 3 hours of the order being received at the factory. Once orders are in production, no changes can be made and liability for the full value of the order lies with the customer.

EDR FORM AND CANCELLATIONS

EDR forms are obtainable from Customer Services and are required where damage has occurred and in situations where a part or complete replacement shutter is required.

On receipt of the form, please complete it in full and send back to Customer Services, with digital photo stills, confirming the fault.

Please see examples and requirements to accompany EDR form below:

- 1) If your shutters are damaged on arrival – please take digital stills of outer packaging.
- 2) Warped panels – panels must be placed on a flat surface and digital still must clearly show the warp on this surface in particular the corners where the panel doesn't make contact
- 3) Incorrect sizes – if the panels don't fit, each individual panel must be measured and inner frame size measured whilst in situ, these measurements should be sent to Customer Services.
- 4) Cancellations/Amendments – Once the order has been confirmed there is a very small time gap between factory receiving order and proceeding with subsequent manufacture of that order. It is therefore essential that you contact Customer Services as soon as possible. We will then endeavour to ascertain whether the order has been processed or if it is possible to stop it. S:CRAFT cannot be held liable for any costs should the order have been processed.

TERMS AND CONDITIONS

1. Definitions

- 1.1 'Buyer' means the person or company who buys or agrees to buy the Goods from the Seller.
- 1.2 'Conditions' means the Terms and Conditions set out in this document and any other terms agreed in writing by the Seller.
- 1.3 'Contract' means the agreement between the Seller and the Buyer for the sale and purchase of the Goods and/or Services incorporating these Conditions, the Order Confirmation and any other terms agreed in writing by the Seller.
- 1.4 'Goods' means the articles which the Buyer agrees to buy from the Seller as set out in the Order Confirmation.
- 1.5 'Order Confirmation' means the written confirmation of the Seller in response to an order for Goods and/or Services placed by the Buyer.
- 1.6 'Seller' means ShutterCraft Ltd trading as S:CRAFT.
- 1.7 'Services' means any services which the Seller is to perform for the Buyer as set out in the Order Confirmation.

2. Conditions Applicable

- 2.1 These Conditions shall apply to all Contracts between the Seller and the Buyer to the exclusion of all other terms and conditions unless expressly agreed in writing by the Seller.
- 2.2 All orders for Goods and/or Services shall be deemed to be an offer by the Buyer to purchase Goods and/or Services pursuant to these Conditions. Acceptance of the offer shall occur when the Seller sends an Order Confirmation to the Buyer (or otherwise on delivery of the Goods or performance of the Services) and a Contract shall come into being.

3. Price and Payment

- 3.1 The price shall be the Seller's quoted price for the Goods as quoted on the Order Confirmation or invoice and subject to any agreed discounts.
- 3.2 The price is exclusive of VAT which shall be due at the rate ruling on the date of the Seller's invoice.
- 3.3 The Seller reserves the right to change prices from those published at any time without prior notice.
- 3.4 Payments unless otherwise stated by the Seller shall be payable by the Buyer 14 days from the date of invoice unless otherwise agreed in writing by the Seller. Time for payment shall be of the essence. The Seller reserves the right at any time to request cash on order in relation to any future orders of Goods. Any extended credit terms must be in writing and signed by a director of the Seller to be valid and shall be subject to the following provisions;
 - 3.4.1 Any credit levels shall be based on such factors as may be decided by the Seller in its absolute discretion and which may include volume purchase levels and historical payment periods taken by the Buyer to settle invoices, credit history and the Buyer hereby confirms that the Seller may seek and obtain a credit report from third party providers for this purpose or request the Buyer to obtain a credit reference from its bank or other third party and to answer all reasonable enquiries relating to credit as requested by the Seller.
 - 3.4.2 The Seller reserves the right in its absolute discretion and for any reason to change or cancel the Buyer's credit levels at any time without prior notice and without any liability to the Buyer.
 - 3.4.3 The Seller reserves the right to provide any credit terms on an order by order basis.
 - 3.4.4 Previous credit levels or terms provided by the Seller to the Buyer do not place any obligation upon the Seller to continue to provide the same level of credit or to provide any credit at all.
- 3.5 The Seller reserves the right to charge interest on all overdue accounts at the rate set out in Late Payment of Commercial Debts (Interest) Act 1998.
- 3.6 Such interest being deemed to accrue on a day-to-day basis from the date payment becomes due until receipt of cleared funds in full settlement.
- 3.7 Payments that are returned to the Seller from the Buyer's bank for whatever reason will incur an administration fee of £30 per transaction which shall be payable by the Buyer in addition.
- 3.8 The cost of any legal correspondence sent to the Buyer from the Seller and other legal expenses incurred by the Seller in pursuing any non payment will be added to the Buyer's total outstanding balance and shall be payable by the Buyer on a full indemnity basis.
- 3.9 Express delivery, special freight, excess storage and carriage charges will be payable in addition by the Buyer and shall be charged on the invoice as quoted on the Order Confirmation, or as advised by the Seller to the Buyer.
- 3.10 In the unlikely event that the Seller is asked by the Buyer to provide a quotation the quotation will be valid for 7 days only.

- 3.11 The Seller reserves the right to increase the price as set out in the quotation or Order Confirmation in line with exchange rate changes or to reflect any increase in the delivery and shipping charges imposed by third party couriers or as a result of an increase in fuel costs, and shall notify the Buyer of such increases which shall be payable in addition by the Buyer.

4. Retention of title

- 4.1 Risk in the Goods supplied to the Buyer by the Seller shall pass on delivery.
- 4.2 Notwithstanding delivery and the passing of risk in the Goods, or any other provision of these Conditions, legal and beneficial ownership and the property in the Goods shall not pass to the Buyer until such time as the Goods and any and all monies owed by the Buyer to the Seller have been paid for in full.
- 4.3 Until such time as the property in the Goods passes to the Buyer:
 - 4.3.1 The Buyer shall hold the Goods as the Seller's fiduciary agent and bailee, and shall keep the Goods separate from those of the Buyer and third parties and properly stored, protected and insured and identified as the Seller's property, but the Buyer may resell or use the Goods in the ordinary course of its business, all proceeds of sale shall be held in trust for the Seller and shall be used to pay all sums due to the Seller for the Goods.
 - 4.3.2 provided the Goods are still in existence, the Seller may at any time require the Buyer to deliver up the Goods to the Seller and, if the Buyer fails to do so forthwith, enter on any premises of the Buyer or any third party including the Buyer's customers and end users where the Goods are stored and repossess the Goods and the Buyer shall ensure that in any contract or agreement it has with its customers it shall reserve such right to the Seller to repossess the Goods, and on request the Buyer shall supply contact details of its customers to enable the Seller to exercise its rights under this clause.
 - 4.3.3 The Buyer shall not pledge, create a lien over or in any way charge by way of security for any indebtedness any of the Goods which remain the property of the Seller, but if the Buyer does so all monies owing by the Buyer to the Seller shall (without limiting any other right or remedy of the Seller) forthwith become due and payable.

5. Made to measure orders

- 5.1 If the Contract is for bespoke Goods manufactured according to measurements provided by the Buyer then the following provisions shall apply.
- 5.2 The Seller manufactures to specific tolerances as determined by the nature of the product and specified within the Seller's published specifications for such Goods only. All orders accepted by the Seller are subject to these specifications.
- 5.3 Made to measure Goods are only accepted on current ordering platforms and must be supported by technical drawings & colour samples where relevant, the seller reserves the right to change the arrangements for placing orders upon notification to the Buyer Unauthorised modifications to the Ordering platforms are not permitted.
- 5.4 Technical drawings and templates need to be clear and unambiguous, with all dimensions and details distinct and legible and must be of a sufficient industry standard to enable a manufacturer to manufacture Goods in accordance with the technical drawing.
- 5.5 It is the Buyer's sole responsibility to ensure the accuracy of the technical drawings and the Seller shall be entitled to assume that all technical drawings supplied are correct and to manufacture Goods in accordance with such technical drawings. The Buyer shall be responsible for the price of the Goods. If the Buyer discovers an error in the technical drawings once the manufacturing process has commenced, the Buyer should inform the Seller immediately and submit corrected technical drawings and the Seller shall use its reasonable endeavours to correct the error however the Buyer shall remain responsible for any Goods manufactured to the old technical drawings which cannot be stopped and for any charges incurred by the Seller in relation to stopping the manufacture or otherwise.
- 5.7 The Seller accepts no liability for order and specification details which are not clearly communicated by the Buyer or which are inaccurate, misleading, incomprehensible or incomplete.
- 5.8 Once an order for Goods is received and the Seller issues an Order Confirmation, the Seller will process it into production subject to receiving any technical drawings or other required specifications (as the case may be). The Seller will not modify the Buyer's measurements in any way and it is the Buyer's responsibility to ensure that the measurements ordered are correct.
- 5.9 Where the Goods are manufactured to the Buyer's specifications the Seller does not warrant or guarantee the Goods' tolerances or fitness for purpose.

- 5.10 Due to the nature of e-mail we recommend that the Buyer activates the "read receipt" functionality in the e-mail when placing its order. The Seller shall not be responsible for any failure to deliver e-mails or other electronic communications.
- 5.11 Following processing the Seller will send an Order Confirmation to the Buyer which includes the Seller's order number. The Buyer should contact the Seller if an Order Confirmation is not received within 2 working days of the initial order being placed.
- 5.12 Confirmation of production and shipment only occurs once the order status states the Goods are in production or shows the Goods as being in transit.
- 5.13 Order Status's are uploaded every 24hrs to the buyers area of the Sellers trade portal the Seller reserves the right to amend the frequency on which this is uploaded.
- 5.14 Orders for Goods may require modification or clarification for technical reasons before production can begin. In these cases the Seller will contact the Buyer by e-mail to clarify and confirm the specification beyond doubt, the Buyer will then communicate in writing the specification required.
- 5.15 The Seller reserves the right to discontinue any product or product range without prior notice that the measurements ordered are correct.
- 5.9 Where the Goods are manufactured to the Buyer's specifications the Seller does not warrant or guarantee the Goods' tolerances or fitness for purpose.
- 5.10 Due to the nature of e-mail we recommend that the Buyer activates the "read receipt" functionality in the e-mail when placing its order. The Seller shall not be responsible for any failure to deliver e-mails or other electronic communications.
- 5.11 Following processing the Seller will send an Order Confirmation to the Buyer which includes the Seller's order number. The Buyer should contact the Seller if an Order Confirmation is not received within 2 working days of the initial order being placed.
- 5.12 Confirmation of production and shipment only occurs once the order status states the Goods are in production or shows the Goods as being in transit.

6. Measuring and ordering responsibilities

- 6.1 The Goods are made to the order dimensions and specifications provided by the Buyer.
- 6.2 It is the Buyer's responsibility to satisfy itself that the dimensions and specification it is ordering is correct.
- 6.3 The Seller accepts no liability for the suitability or accuracy of the dimensions and specification relating to the Goods ordered notwithstanding that from time to time the Seller and its staff may provide advice or guidance and/or be in attendance on site at the measuring phase, at the request of the Buyer. Subject to clause 14, where such assistance is provided, it is without liability.

7. Cancellation of the order by the Buyer

- 7.1 Modifications, amendments and cancellations to the order after confirmation can only be made with the Seller's written agreement without which the Buyer accepts full liability for the cost of the Goods under these Conditions.
- 7.2 Since the Goods are made to measure, once production has begun cancellations cannot be accepted and full payment will be required.
- 7.3 The Buyer is advised to secure payment of a non-refundable deposit from their customers prior to placement of the order with the Seller.

8. Documentation and Samples

- 8.1 Subject to clause 14, product specifications, brochures and other literature and any depiction of the Goods in such are supplied for the Buyer's general guidance only and shall not constitute representations by the Seller and the Seller shall not be bound thereby.
- 8.2 Specifications and literature may be changed by the Seller at any time.
- 8.3 Subject to clause 14, samples and published images are provided as indicative examples of the finished product only, finished Goods may vary slightly from the samples and pictures and are not guaranteed to be identical to the finished product.
- 8.4 The Seller is not liable for slight variations in colour or finished appearance.
- 8.5 The Seller cannot guarantee that Goods supplied at different times will match one another. Colours shades may vary by +/- 10%.
- 8.6 The Seller offers a custom colour facility for selected product ranges. Where a custom colour is required the Seller will require a sample of the colour for matching purposes unless the colour is referenced to one of the custom colour palettes listed in the Seller's product specifications in which case it is sufficient to provide the colour reference number.
- 8.7 All colour references not contained within the approved colour palettes in the Seller's product specification need to be matched to a physical sample of the colour provided by the Buyer. Please supply two samples, one for production and one for ordering purposes. The Seller recommends that the Buyer keeps a third sample for its

reference. The Seller will match colours to samples as closely as possible but cannot guarantee an identical match.

9. Trade accounts

- 9.1 The Seller reserves the right to refuse to accept orders or to discontinue trading or otherwise withdraw supply without prior notice.
- 9.2 Where an account is inactive for six months the Seller may require new account application details be provided.
- 9.3 Where the Buyer's ownership and account details have changed the Seller must be notified of these changes in writing.
- 9.4 The Seller reserves the right to change the Buyer's discount levels at any time.
- 9.5 Discount levels shall be based on such factors as may be decided by the Seller in its absolute discretion and which may include volume purchase levels and historical payment periods taken by the Buyer to settle invoices and such discounts will be allocated on an order by order basis. Previous discount levels provided by the Seller to the Buyer do not place any obligation upon the Seller to continue to provide the same discounts or to provide any discount at all.

10. Non standard sizes

- 10.1 Certain orders for Goods, including those with special shapes or templates, will be confirmed with a CAD drawing before production. The Seller will forward the CAD drawing to the Buyer by e-mail which must be confirmed in writing by the Buyer that the CAD is an accurate representation of the Buyer's order requirements.
- 10.2 The additional time required for CAD production and approval is an accepted part of the ordering process.
- 10.3 In cases where the installation is fitted to an irregular sized aperture, a template and or technical drawing of the aperture may be require
- 10.4 Templates and technical drawings should be supplied to the Seller at the same time as the order is placed since the order cannot be progressed without these. It follows that if such documents can be sent electronically delay is significantly reduced. Please note that in some cases a template can be rendered on a technical drawing, so long as sufficient, clear measurements are provided to accurately represent the shape. In such cases the template can be sent electronically.

11. Ex-stock orders

- 11.1 In addition to the supply of Made to Measure orders we may also sell a limited range of Goods from stock. Whilst every effort is made to hold appropriate stock levels of such items, availability is not guaranteed and goods may be withdrawn from sale without prior notice.

12. Deliveries

- 12.1 The Seller will contact the Buyer to arrange delivery of the Goods. All dates and delivery times given are estimates only which are given as a guide and without liability and may be subject to change without prior notice. Time is not of the essence and the Seller accepts no liability where timings vary from the estimates given.
- 12.2 The Seller reserves the right to charge the Buyer a missed delivery charge in addition to any regular delivery charges in cases where, despite a pre-arranged delivery agreement, the Buyer is not present to accept delivery.
- 12.3 Delivery shall take place at the Buyer's main place of trading. Other delivery destinations may be arranged by request but will be subject to special delivery charges which vary according to volume and location as advised and which the Buyer shall be responsible for paying.
- 12.4 The Seller endeavours to deliver all Goods with minimum delay. In the event that the Seller is required by the Buyer to hold Goods for a period greater than seven days, weekly warehouse storage charges will apply per full week the Goods remain with the Seller, which the Buyer shall be responsible for paying.
- 12.5 The Seller is responsible for the delivery of Goods to the Buyer's premises or agreed delivery location. The Buyer is responsible for receiving and checking the Goods and storing them within their premises. Delivery notes must be signed for and mis-deliveries, packaging damage or shortages at the time of receipt should be noted on the delivery note at the time of delivery and notified to the Seller with 72 hours; failure to notify shall be deemed the Buyer's acknowledgement of the correct delivery and acceptance of the Goods.
- 12.6 The Seller reserves the right to hold delivery of Goods until such time the Buyer's credit with the Seller is in line with agreed limits, or such period as the Seller so determines.
- 12.7 Subject to clause 14.4 The Seller does not accept consequential liability for goods which are lost, short delivered or damaged, and for the purposes of this clause consequential liability shall include but not be limited to any loss suffered by the Buyer's customer as a result of incomplete set of shutters being installed or otherwise, and loss of profit, loss of goodwill, loss of opportunity or contract or any other loss as a result of the customer cancelling any order with the Buyer or otherwise.

- 13. Installation responsibility**
- 13.1 Installation of the Goods is carried out by and is the responsibility of the Buyer who must ensure that the Goods are fitted by suitably qualified installers.
- 13.2 Subject to the provisions of clause 14.4 the Seller accepts no responsibility for the quality or suitability of the installation and carries no liability for any damage or injury which may arise during fitting notwithstanding the fact that from time to time the Seller or its staff may provide advice or guidance and/or be in attendance on site at the fitting phase, at the request of the Buyer. Where such assistance is provided it is without liability.
- 14. Warranty and Liability**
- 14.1 Goods conforming to the published specification are covered by the Seller's warranty set out in clause 14.3.
- 14.2 Goods which fall outside of the Seller's standard specification may be manufactured at the Seller's discretion but no part of the Goods will be covered by warranty.
- 14.3 Subject to the following provisions, the Seller warrants that (a) the Goods will correspond with their specification published by the Seller at the time of delivery and the Colour fastness will remain true for a period of 3 years, and (b) the Shutters will be free from defects in workmanship for a period of 3 years from delivery and (c) the Hardware will be free from defects for a period of 1 year from delivery and (d) the Stainless steel Hardware will be free from defects for a period of 3 years from delivery,
- 14.3.1 The above warranty is given by the Seller subject to the following conditions:
- 14.3.1.1 the Seller shall be under no liability in respect of any defect in the Goods arising from any drawing, design or specification supplied by the Buyer;
- 14.3.1.2 the Seller shall be under no liability in respect of any defect arising from fair wear and tear, wilful damage, negligence, abnormal working conditions, failure to follow the Seller's instructions (whether oral or in Writing), misuse or alteration or repair of the Goods without the Seller's approval;
- 14.3.1.3 the Seller shall be under no liability under the above warranty (or any other warranty, condition or guarantee) if the total price for the Goods has not been paid by the due date for payment;
- 14.3.1.4 the above warranty does not extend to parts, materials or equipment not manufactured by the Seller, in respect of which the Buyer shall only be entitled to the benefit of any such warranty or guarantee as is given by the manufacturer to the Seller.
- 14.3.2 Subject as expressly provided in these Conditions, all warranties, conditions or other terms implied by statute or common law are excluded to the fullest extent permitted by law and where the Goods are sold to a person dealing as a consumer (within the meaning of the Unfair Contract Terms Act 1977) the statutory rights of the Buyer (as a consumer) are not affected by these Conditions.
- 14.3.3 A claim by the Buyer which is based on any defect in the quality or condition of the Goods or their failure to correspond with the Seller's published specification shall (whether or not delivery is refused by the Buyer) be notified to the Seller within seven days from the date of delivery or (where the defect or failure was not apparent on reasonable inspection) within a reasonable time after discovery of the defect or failure and the defective Goods shall be returned to the Seller at the Buyer's cost. If delivery is not refused within the above time period, and the Buyer does not notify the Seller accordingly, the Buyer shall not be entitled to reject the Goods and the Seller shall have no liability for such defect or failure, and the Buyer shall be bound to pay the price as if the Goods had been delivered in accordance with the Contract.
- 14.3.4 On receipt of the defective Goods the Seller shall inspect the same and if it verifies the defect the remaining provisions of this clause 14.3 shall apply, however, if the Seller does not verify the defect then it shall reject the warranty claim and shall return the Goods to the Buyer at the Buyer's cost.
- 14.3.5 Where a valid claim in respect of any of the Goods which is based on a defect in the quality or condition of the Goods or their failure to meet the Seller's published specification is notified to the Seller in accordance with these Conditions, the Seller may replace the Goods (or the part in question) free of charge or, at the Seller's sole discretion, refund to the Buyer the price of the Goods (or a proportionate part of the price), in which case the Seller shall have no further liability to the Buyer.
- 14.3.6 Where the Seller replaces the Goods in accordance with clause 14.3.5 then the replacement Goods shall be shipped by sea from the manufacturing plant in China (or such other manufacturing plant) to the UK and then delivered to the Buyer's premises or such other location as may be agreed by the Supplier in writing. If the Buyer wishes the replacement Goods to be shipped by air freight then the Buyer shall be responsible for the additional charges incurred in shipping.
- 14.3.7 The Seller shall not be responsible for any costs associated with the removal of any defective Goods from the end user premises or the installation of any replacement Goods or any remedial visits.
- 14.4 Nothing in these Conditions shall limit or exclude the Seller's liability for: death or personal injury caused by its negligence, or the negligence of its employees, agents or subcontractors (as applicable); or fraud or fraudulent misrepresentation; or breach of the terms implied by section 12 of the Sale of Goods Act 1979 or section 2 of the Supply of Goods and Service Act 1982; or defective products under the Consumer Protection Act 1987; or any matter to the extent to which it would be unlawful to exclude or restrict liability.
- 14.5 Subject to clause 14.4, the Seller shall under no circumstances whatever be liable to the Buyer, whether in contract, tort (including negligence) or restitution, or for breach of statutory duty or misrepresentation, or otherwise, for any the following heads of claim and each one of the following shall be deemed a separate head of claim: (i) loss of profit; (ii) loss of goodwill; (iii) loss of business; (iv) loss of business opportunity; (v) loss of anticipated saving; (vi) loss or corruption of data or information; or (vii) special, indirect or consequential loss; arising under or in connection with the Contract; and
- 14.6 The Seller's total liability in respect of all other loss or damage arising under or in connection with the Contract, whether in contract, tort (including negligence), breach of statutory duty, or otherwise, shall in no circumstances exceed the price of the Goods under the relevant Contract.
- 14.7 If a number of defaults give rise to substantially the same loss or are attributable to the same or similar cause, then they shall be regarded as giving rise to only one claim.
- 14.8 The Seller will be afforded a reasonable opportunity to remedy any such defaults.
- 14.9 This clause 14 shall survive termination of the Contract.
- 14.10 The Seller shall not be liable to the Buyer or be deemed to be in breach of the Contract by reason of any delay in performing, or any failure to perform, any of the Seller's obligations in relation to the Goods, if the delay or failure was due to any cause beyond the Seller's reasonable control including but not limited to:
- 14.10.1 acts of God, explosion, flood, tempest, fire or accident;
- 14.10.2 war or threat of war, sabotage, insurrection, civil disturbance or requisition;
- 14.10.3 acts, restrictions, regulations, bye-laws, prohibitions or measures of any kind on the part of any governmental, parliamentary or local authority;
- 14.10.4 import or export regulations or embargoes;
- 14.10.5 strikes, lock-outs or other industrial actions or trade disputes (whether involving employees of the Seller or of a third party);
- 14.10.6 difficulties in obtaining raw materials, labour, fuel, parts or machinery; and 14.10.7 power failure or breakdown in machinery.
- 15. Return of Goods**
- 15.1 The return of Goods for credit will not be accepted without prior notification to the Seller and written acceptance by the Seller and shall be substantiated with photographic evidence prior to return.
- 15.2 Goods to be returned must be suitably packaged to prevent loss or damage in transit.
- 16. General**
- 16.1 This agreement, and any documents referred to in it, constitute the whole agreement between the parties and supersede any previous arrangement, understanding or agreement between them relating to the subject matter they cover.
- 16.2 If any provision of this agreement (or part of a provision) is found by any court or administrative body of competent jurisdiction to be invalid, unenforceable or illegal, the other provisions shall remain in force.
- 16.3 If any invalid, unenforceable or illegal provision would be valid, enforceable or legal if some part of it were deleted, the provision shall apply with whatever modification is necessary to give effect to the commercial intention of the parties.
- 17. Jurisdiction**
- 17.1 These terms and conditions are governed by the laws of England and the parties shall submit to the Jurisdiction of the English courts.



Newdown Farm
Micheldever
Winchester
Hampshire
SO21 3BT
01962 794530
www.s-craft.co.uk

ShutterCraft Ltd.
(Trading as S:CRAFT)