

CUBA TECHNICAL SPECIFICATIONS



2023 Version 2.4



CUBA SPECIFICATIONS CONTENTS

To go to required section click below:

Section 1		
Introduction	3	
Specifications	4	
Colours	5	
Section 2		
Installation Styles	6	
Full Height		
Cafe Style		
Tier on Tier		
Tracked Shutters		
Shutters Used as Doors		
Section 3		
Framing elements		
Frame styles	7	
Beaded		
Insert L		
Deep Plain L		
Double Insert L		
Tiara Z		
Crown Z		
Beaded Z	9	
Bullnose Z		
Ridge Deco		
Serrate Z		
Camber Deco	10	
Insert Hang Strip		
Mission Frame		
Cover Strip		
T Posts		
L/Z	11	
Deco		
Corner Posts		
L/Z	12	
Deco		
Bay Posts		
L/Z		
Dec		
Battens	13	
Section 4		
Panel details	15	
Stile		
Rails	16	
Top & bottom rail sizes		
Louvres	17	
Louvre pin		
Tilt Rods		
Standard tilt rod		
Silent tilt rod		
Offset tilt rod	18	
Offset tilt rod for Multi-fold Shutters		
Section 5		
Room Darkening	19	
Section 6		
Hardware	26	
Bolts & Ring Pulls	28	
Panel Configurations	31	
Section 7		
Sizing & Measuring	35	
Order Size Definition		
Overall Panel size (OP)		
Overall Dimension of frame (OD)		
Tolerances	36	
Mounting Type		
Cleaning Recommendations		
Section 8		
Warranty, EDR & Cancellations	37	
Terms & Conditions	38	

1. CUBA INTRODUCTION

Cuba blends premium hardwood panels and eco-friendly engineered wood composite (EWC) frames, for a more accessible and luxurious range of wood shutters. The panels are custom crafted from 100% hardwood using premium quality timbers from qualified sustainable sources. The specialised hardwood makes the shutter panels lighter allowing multiple hinged panels, which are mounted to robust EWC frames and make this range an ideal solution for large expanses

Frames and Panels:

Large range of frames available.

Stiles:

Please note the stiles are manufactured in a flat or beaded stile. The engineered stiles are reinforced by using multiple layers of wood bonded together ensuring that the panel does not twist or warp.

Louvres:

Cuba is available in 47mm, 63mm, 76mm, 89mm, elliptical louvres.

Special Shapes:

No special shapes are available.

Colour palette:

There are a total of 12 colours available. Including custom colour (surcharge).

Shutter Range	Finish	Louvre Material	Stile Material	Rail Material	Frame Material
Cuba	Solid Paint	Ayous/White Teak	Basswood/White Teak/ Ayous + Poplar LVL	Ayous (Divider rail: Basswood/White Teak)	MDF



CUBA SPECIFICATIONS

PANEL SIZE LIMITATIONS

Louvre Size	Width				Height		
	Minimum	Maximum			Minimum	Maximum	Mid rail Required if
		Single hung	Bi-fold hinged shutter/ Multi-fold with Top and Bottom track	Multi-fold hinged shutters & multi-fold with Top track only			
47mm	152mm	750mm	660mm	550mm (No. of panels ≤ 4)	250mm	3000mm	H>1981mm
63mm	152mm	890mm			250mm	3000mm	H>1981mm
76mm	152mm	890mm			250mm	3000mm	H>1981mm
89mm	152mm	890mm			250mm	3000mm	H>1981mm

SPECIFICATIONS

Material	Frame MDF, Panel Hard Wood
Panel Weight per sqm	7.31-7.88 kg
Paint Colours	23
Stain Colours	✗
Custom Colours available (solid colours only)	✓
Louvre sizes	47mm 63mm 76mm 89mm
Max single panel width	750mm : 47mm 890mm : 63mm 890mm : 76mm 890mm : 89mm
Max multi panels width	550mm : REST
Max number of panels hinged together	4 (1 if a doorway)
Max and min panel heights. (For panel height over 2500mm, it is suggested using 50.8mm or 57mm stile to aid structural integrity).	3000mm 250mm
Solid Panels available	✗
Special shapes	✗
Custom Bay Post angles	✓
Stile Type	Beaded & Flat
Fixed Louvres	✓

COLOURS

Please note. Colours may vary slightly between dye lots. Shutters for the same installation should be ordered together to avoid variations in colour. Colours may vary slightly from colour samples. For this reason, colour samples should be updated annually.

PAINT

Please note that 001 pure white, and 003 silk white, are water-based paints and the rest of the colours are finished in an oil-based paint.

COLOUR OPTIONS

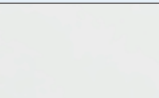
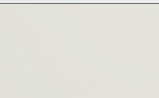
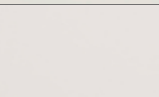
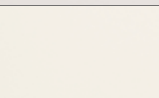
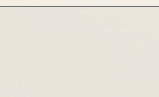
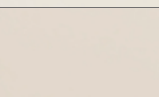
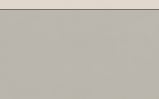
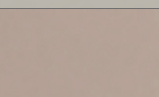
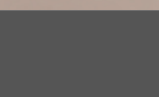
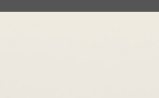
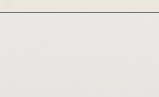
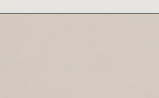
CUBA PAINT OPTIONS (12 COLOURS + CUSTOM COLOUR WITH A SURCHARGE)				
Colour ID	Colour Name		Recommended Hinge Colour	Optional Hinge Colour
001	Pure White		Pure White	1. Antique Brass 2. Bisque 3. Black 4. Bright Brass 5. Brown Grey 6. Brushed Nickel-Plated 7. Crisp Linen 8. Nickel-Plated 9. Pearl 10. Pure White 11. Sea Mist 12. Stainless Steel 13. Stone Grey 14. String 15. Taupe Grey 16. White
002	Extra White		White	
003	Silk White		White	
004	Bright White		White	
006	Pearl		Pearl	
009	Creamy		Pearl	
032	Sea Mist		Sea Mist	
049	Stone Grey		Stone Grey	
053	Clay		Nickel Plated	
063	Decorator's White		White	
076	Aura White		White	
080	Taupe Grey		Taupe Grey	

Due to the nature of material manufacturing, colours may vary slightly between dye lots. Please order shutters for the same home at the same time. Slight variations may also occur between the finished products and the colour swatches you use.

©S:CRAFT Copyright in this material belongs to S:CRAFT and copying or reproduction in whole or in part is strictly prohibited. We reserve the right to alter specifications without prior notice.

2. INSTALLATION STYLES



FULL HEIGHT

Shutter covering the full height of aperture.



TRACKED SHUTTERS

Bi-Fold

Shutters suspended from a top track hinged together in a bi-fold configuration to allow them to be folded back to the end of the track at 90° or 180°. Suitable for use with patio doors, wardrobes or as a room divider. May be specified and fitted with or without side frames.

By-Pass

Shutters suspended from a top track. Panels slide behind or in front of one another to open or close. Suitable for use with patio doors, room dividers and wardrobes. May be specified and fitted with or without side frames.

* Refer to the separate track specifications for further details.

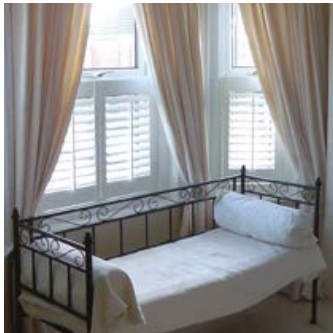

CAFE STYLE

Shutter covering only the lower portion of aperture providing privacy and light control but leaving the top portion un-shuttered to maximise light, where privacy is not required.



SHUTTERS USED AS DOORS

In situations where shutters will be used for a door application, the customer must inform S:CRAFT when placing the order.

Panel Configuration

L, R, LR	LL, RR, LLRR
	Only available with a tracked installation.
Manufactured with warranty waived	Not covered by warranty.



ROOF SHUTTERS

Would not be supplied or covered under warranty.

Please refer to Fiji specifications for roof details.



TIER ON TIER

Shutter is split into two halves so the top and bottom panels can be independently operated / opened fully. The standard gap between top tier and bottom tier is 2.5mm. For multi-fold tier on tier shutters only 3 or less multi-fold panels are within warranty.

Please note:

1. The factory will add extra hinges to support the panels
2. The factory will add a larger and stronger top and bottom rail. This will reduce the risk of panels sagging.

N.B Customers will be responsible for any EDR re-order where there has been a failure to notify S:CRAFT that the original shutter order was for a door application.

*We only offer triple-fold panel configuration (e.g. LLL/RRR) Tier on Tier Shutter.

If a four-fold panel configuration (e.g. LLLL/RRRR) tier on tier is requested then the warranty will be waived automatically.

©S:CRAFT Copyright in this material belongs to S:CRAFT and copying or reproduction in whole or in part is strictly prohibited. We reserve the right to alter specifications without prior notice.

FRAMING STYLES

BEADED

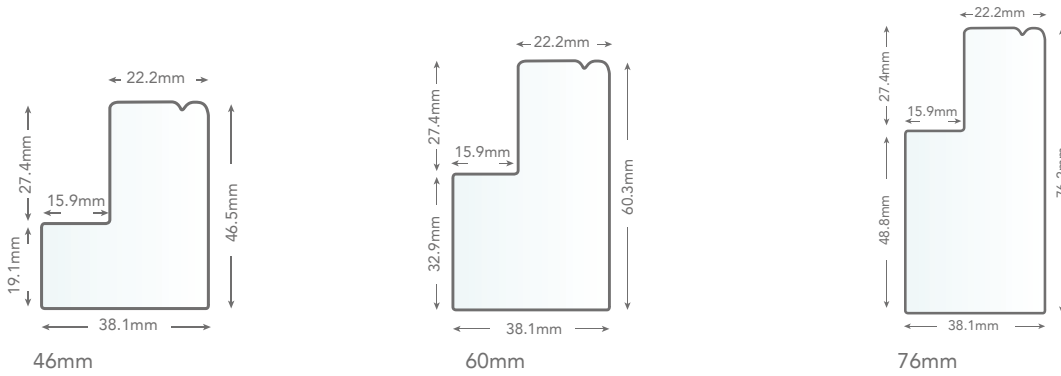

INSERT L

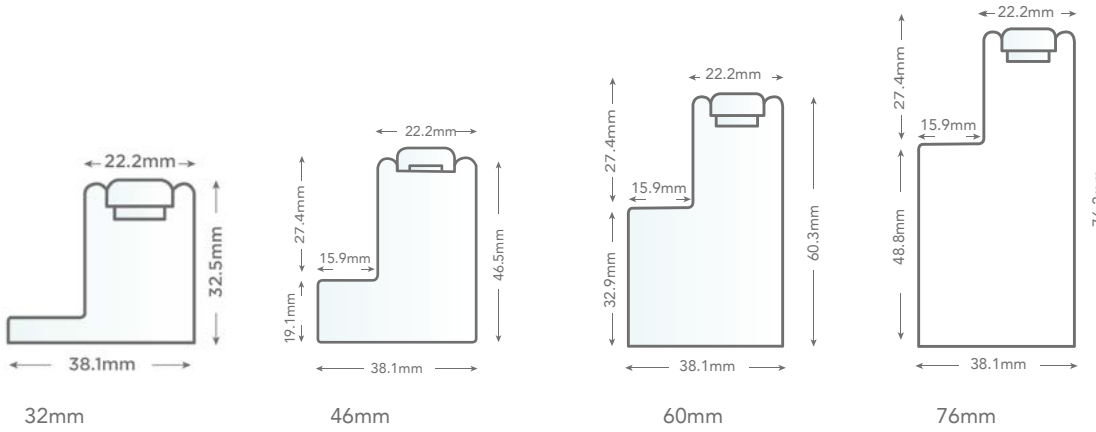

DEEP L PLAIN

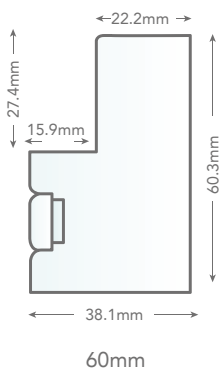

PLAIN L FRAME

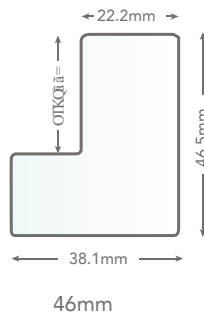

FRAMING STYLES

DOUBLE INSERT L FRAME

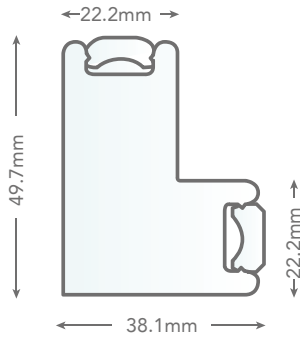

Double Insert L Frame
50mm

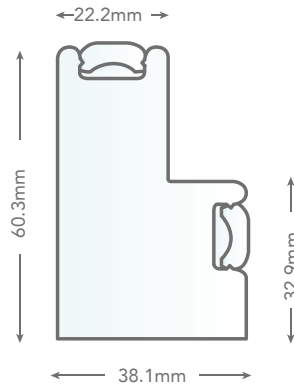

Double Insert L Frame
60mm

NB. Please note that no screw holes will be pre-drilled for the Double Insert L Frame, but 76.2mm screws will be supplied loose in the hardware box.

TIARA Z FRAME

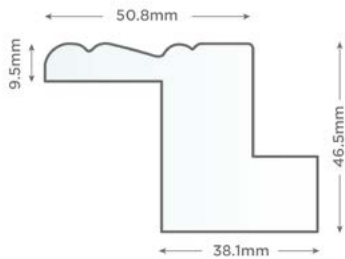

50mm

TIARA Z SILL PLATE

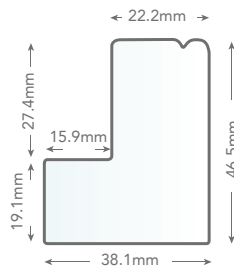

50mm

CROWN Z FRAME

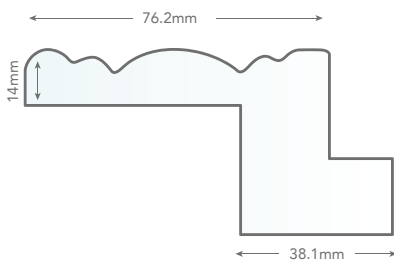

76mm

CROWN Z SILL PLATE

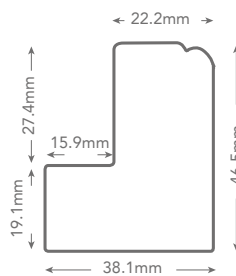

46mm

BEADED Z

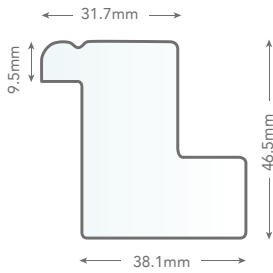

31mm

BEADED Z SILL PLATE

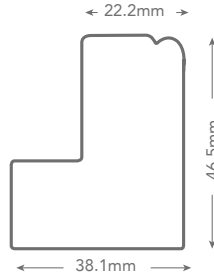

BULLNOSE Z

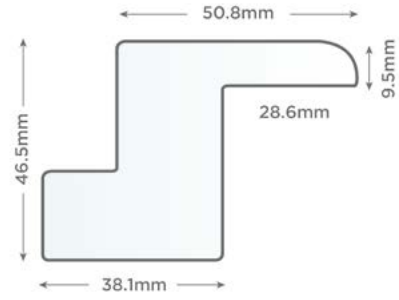

50mm

BULLNOSE Z

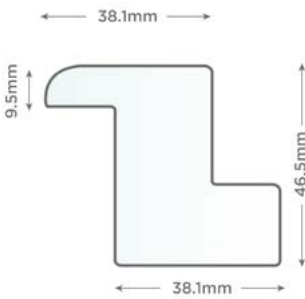

38mm

BULLNOSE Z SILL PLATE

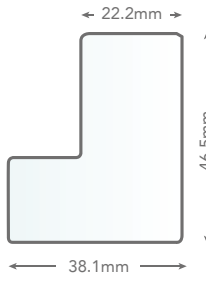

38mm

DEEP BULLNOSE Z

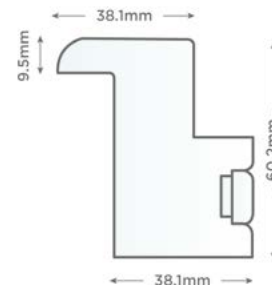

38mm

Please note: the Deep Bullnose Z Frame uses the Deep Plain L Frame W/ Insert for the sill plate

RIDGE DECO FRAME

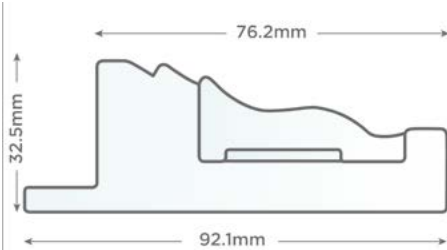

76mm

RIDGE DECO SILL PLATE

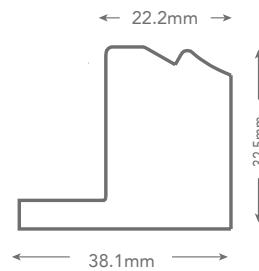

38.1mm

SERRATE Z FRAME

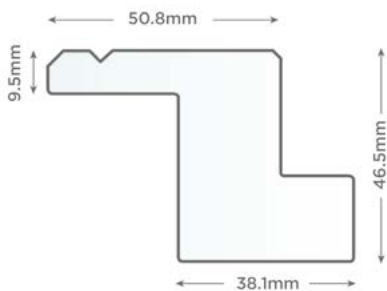

50mm

SERRATE Z SILL PLATE

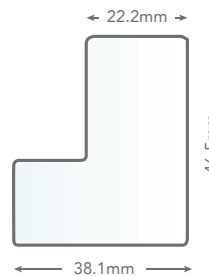

46mm

CAMBER DECO FRAME

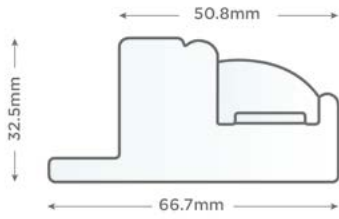

50mm

CAMBER DECO SILL PLATE

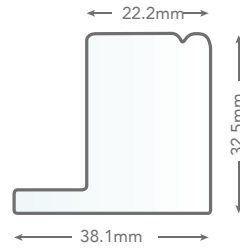

HANG STRIP WITH INSERT

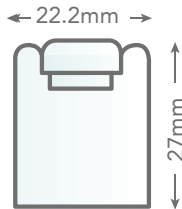

27mm

MISSION DECO FRAME

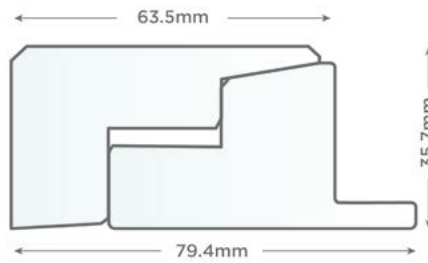

63mm

PRE-DRILL L FRAMES (INSIDE MOUNT ONLY) OR Z FRAMES

Please note that the predrilled hole and the plug will not be a 100% complete fit, but that would not affect the performance of the screw. Shutters can't be remade solely because of this issue.



COVER STRIP*



25mm

COVER STRIP*

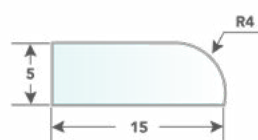

15mm

* Cover strips are made in wood.

T-POST

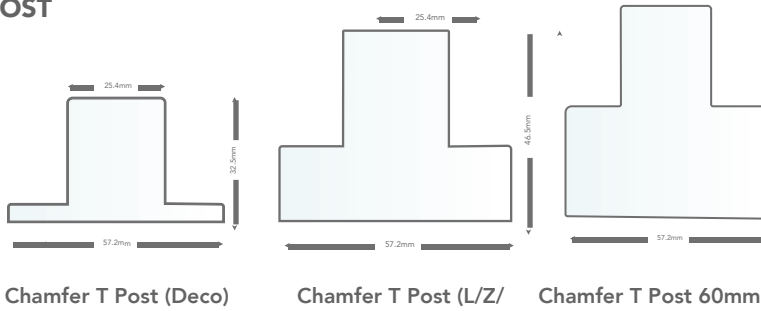

NB. Please note that horizontal T Posts over 1219mm are not covered by warranty.

NB. When ordering the panel configuration with a vertical T-post and only some of the panels have a top frame or a bottom frame, the T-post will extend to the top frame or bottom frame OD size by default.

T-POST W/INSERT

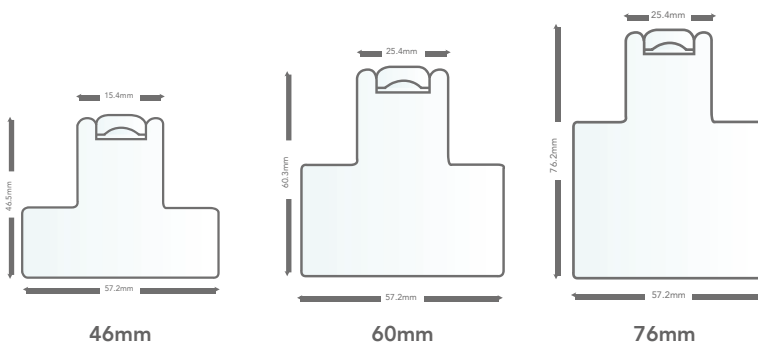

NB. Please note that horizontal T-Posts over 1219mm are not covered by warranty. Only vertical T Posts are adjustable. When the customer requires all or some frames, there will be no predrilled hole by default. T-post's with insert will be predrilled as default.

T-POST CONNECTOR

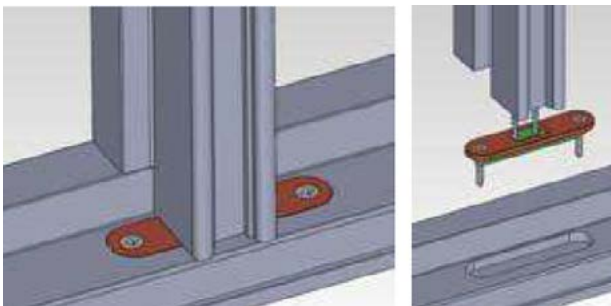

T-Post connectors are available for Antigua, Bermuda, Cuba, Java, Fiji and Samoa.

Available colors: Pure White, White, Pearl, Bisque, Black and Nickel-Plated.

Available for 25mm and 44mm face width T-Posts.

T-Post connectors can be used with the following frames and posts:

L FRAME

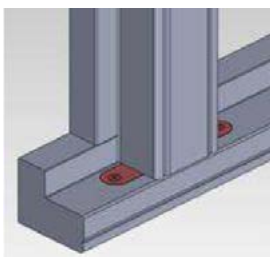

DECO FRAME

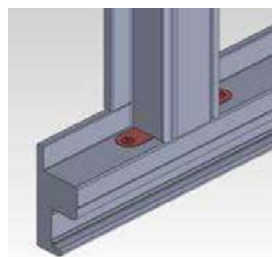

Z FRAME

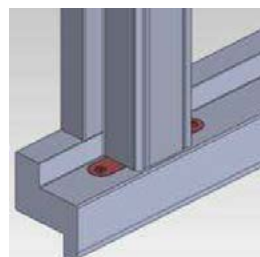

HANG STRIP (BESIDE)

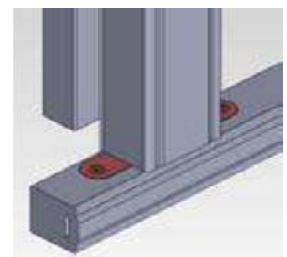

1. For Hang Strip, some special shape shutters and Horizontal T-Posts, the connector fixing is not supplied and T-Post will be installed by screws and dowels instead.

2. If there is a barrel bolt or sleeve & base plate (Java) which may interfere with the T-Post connector, all the T-Posts for the entire shutter will be installed with screws and the frames will be pre-drilled.

3. The screw colour will match with that of the T-Post connector colour, except Java which will be stainless steel screws.

CORNER POST

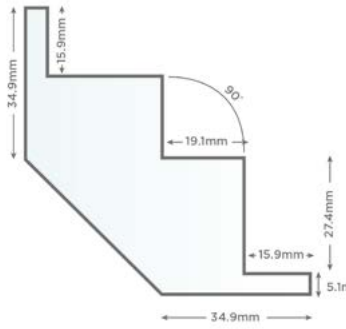

(Deco Frame)
32mm

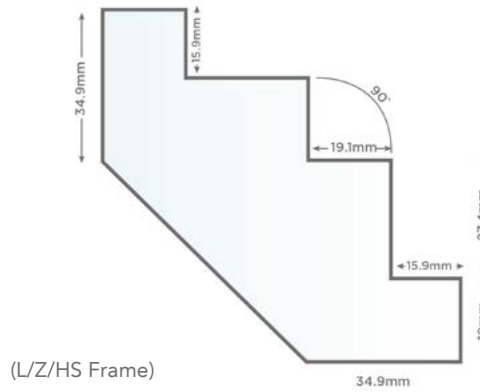

(L/Z/HS Frame)
46mm

BAY POSTS

Additional custom angles are also available in all materials.

135° angle

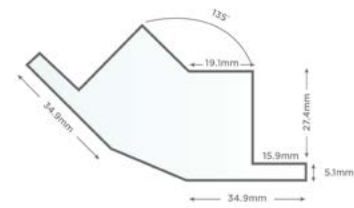

(Deco Frame)
32mm

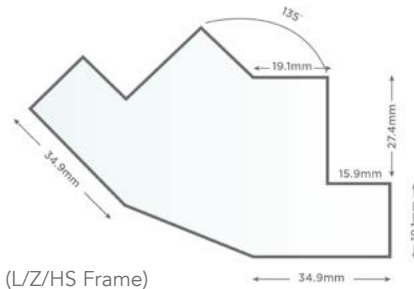

(L/Z/HS Frame)
46mm

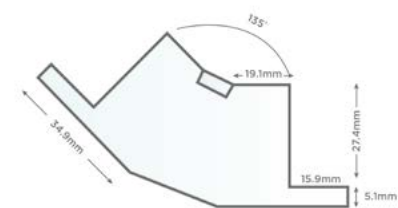

(Deco Frame)
32mm with insert

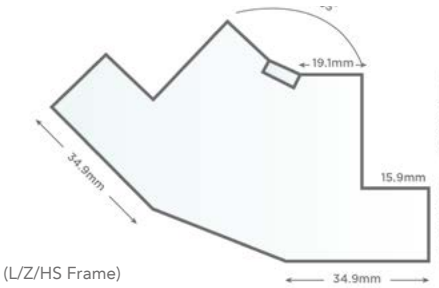

(L/Z/HS Frame)
46mm with insert

Frames split when the frames length exceed the below limitation.
 When frame lengths (including shutter frames, batten, fascia, header and tracks for track system) exceed the limitation, then the frames will be split as the below chart describes. Please review the chart for reference.

Shipping Method	Program	Frame Length (L) (mm)
Standard shipping	all programs	3630<L≤7260 (2 sections)/ L>7260 (3 sections)
Airfreight	all programs	3048<L≤6096 (2 sections)/ 6096<L≤9144 (3 sections)

BATTENS

Battens can be butt-jointed as per the drawings below:



Battens and Panels identification: The S:CRAFT order number will be stamped on the bottom of each panel and one end of each corresponding batten to identify which one belongs to which item.

Standard sizes:

Stock Battens are available in the following sizes

- | | |
|--------------|--------------|
| Made of Wood | Made of MDF+ |
| 2.5mm x 27mm | 25mm x 30mm |
| 3mm x 15mm | 25mm x 40mm |
| 3mm x 20mm | |
| 3mm x 30mm | |
| 3mm x 60mm | |
| 5mm x 45mm | |
| 5mm x 63.5mm | |
| 30mm x 40mm | |
| 40mm x 40mm | |

Other size battens are made of wood.

Minimum charge one linear meter per batten

Batten Identification: Order number will be stamped on one end of the battens to identify which batten belongs to which line.

Build-out (Extension)

- For L/Z/Deco/Hang Strip Frame including T-Post, we will pre-attach the build-out of which the thickness is less than 50.8mm (including 50.8mm) by default;
- For L/Z/Deco/Hang Strip Frame including T-Post, when build-out is over 50.8mm, we will supply build-out loose with holes pre-drilled; also note that for frame not able to pre-drill holes, such as Beaded L Frame, we will supply build-out loose without holes pre-drilled, either.
- For all frames, we will add build-out per the order form. E.g., if the frame type is 76mm L Frame, and build-out is 10mm, we

will use 76mm L Frame added with 10mm build-out instead of changing the frame type to 46.5mm L Frame added with 39.7mm build-out. For bay/corner Post, we will supply build-out in every size pre-attached by default.

- Buildout for Z Frame: If you want the buildout to be added to the bottom of Z frame like the drawing below on the right, please ALWAYS specify in the special notes of the order form, "Add buildout on back of frame". The DEFAULT BUILDOUT will be the left drawing.

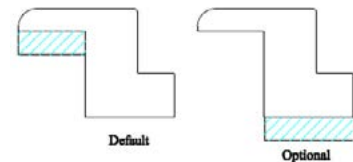

NB. For bay and corner post, we will supply build out in every size pre-attached by default.

BUILDOUT

The default position for L/Z/Deco/Hang Strip frame with buildout are as follows:

1. L Frame with buildout, the default position is the back of the frame. Please see Beaded L frame 46mm as an example:

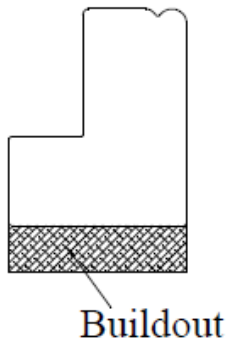

2. For the Z Frame with buildout, the default position is the back lip of the frame. Please see examples below:

Tiara Z Frame 50mm

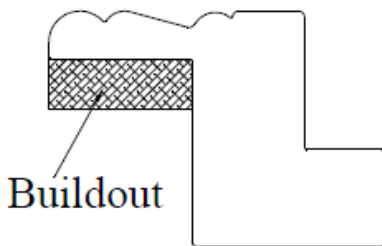

Crown Z Frame 76mm

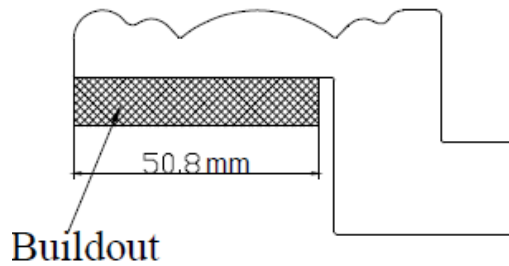

3. For the Deco Frame with buildout, the default is to have a full buildout positioned at the back of the frame. Please see example below of the Camber Deco Frame 50mm:

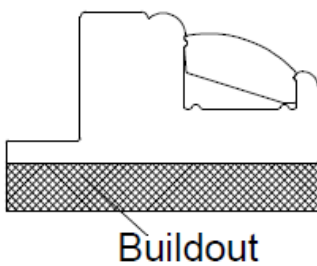

4. For the Hang Strip with Insert (beside the panel), the default is the back of the frame, as shown below on the 22mm Hang Strip with Insert:

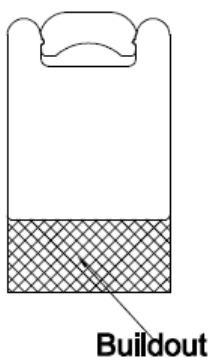

4. PANEL DETAILS

STILES

Beaded

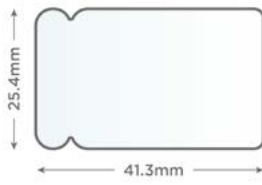

41.3mm Butt Stile

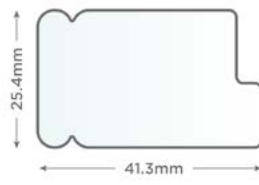

41.3mm Rebate Stile

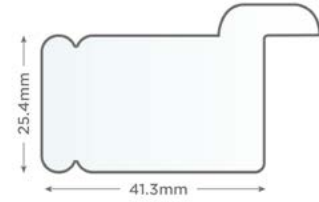

41.3mm D-Mould Stile

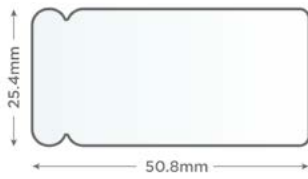

50.8mm Butt Stile

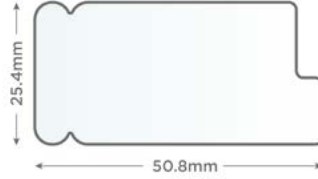

50.8mm Rebate Stile

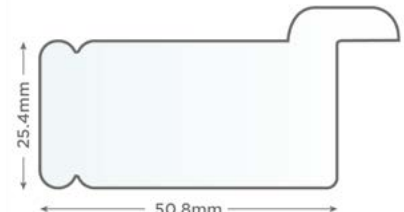

50.8mm D-Mould Stile



57.2mm Butt Stile



57.2mm Rebate Stile



57.2mm D-Mould Stile

Flat

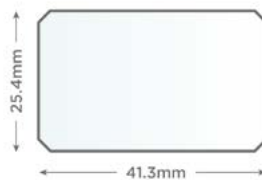

41.3mm Butt Stile

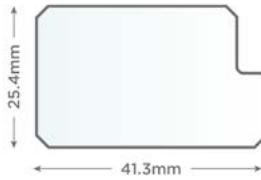

41.3mm Rebate Stile

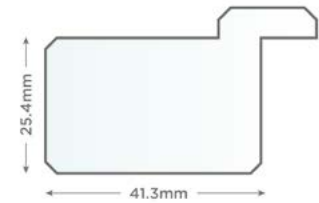

41.3mm D-Mould Stile

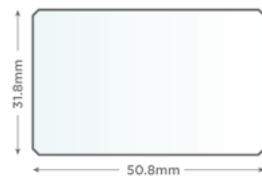

50mm Butt Stile



50mm Rebate Stile



50mm D-Mould Stile



57mm Butt Stile



57mm Rebate Stile

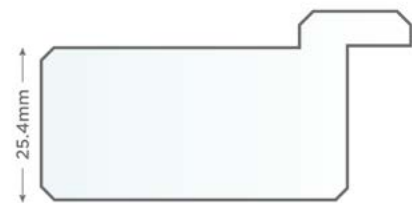

57mm D-Mould Stile

RAILS

The factory will decide the size, unless otherwise specified in the notes section on order form. The top and bottom rail will be the same size or similar if there is no divider rail. If you need different size rails, please specify.

We suggest ordering shutters for the same customer at the same time, so that the rail sizes will match as accurately as possible.

Please note the standard top/bottom rail sizes should be within 69.85mm~165.1mm.

For regular shutters, the increments for the rail size is 3.175mm.

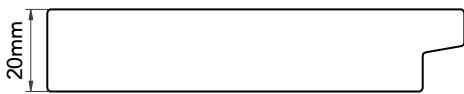

STANDARD MID-RAILS

The Mid-Rail size is 76.2mm high. Different mid-rail sizes cannot be ordered in Cuba.

If the panel height is greater than 1879mm one or more mid-rails are required. If the height from the centre of the mid-rail to the top of the top rail or bottom of the bottom rail is 1879mm or more, then another mid-rail is required. Mid-rail positions should be specified at time of ordering. If the order is placed with no mid-rail then all warranties on the order are automatically waived.

Divider rail:
Standard divider rail is 76.2mm

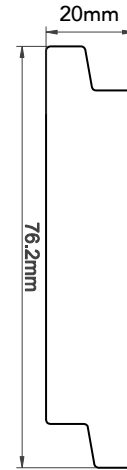

MID-RAIL continued

Specified rail position is taken from the base of the shutter set to the centre point of the rail, except for solid based which is from the bottom to the top of the mid-rail.

The centre rail can deviate by + or - by the amount of millimetres shown below. If the mid-rail is to be exact with no deviation then this must be noted on the order under the notes when placing the order.

Louvre Size	Allowable +/- Deviation
47mm	19mm
63mm	25mm
76mm	31mm
89mm	38mm

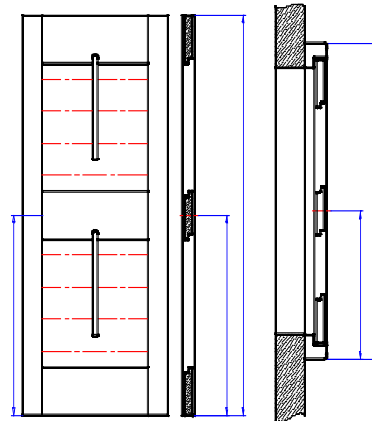

TOP & BOTTOM RAIL SIZES

Panel Height	Top & Bottom Rail Minimum size	Top & Bot. Rail Maximum size			
		47mm louvre	63mm louvre	89mm louvre	114mm louvre
254mm~= 508mm	69.85mm	104.775mm	117.475mm	127mm	152.4mm
508mm~= 1143mm	76.2mm	104.775mm	117.475mm	127mm	152.4mm
1143mm~1625.6mm	85.725mm	165.1mm	165.1mm	165.1mm	165.1mm
1625.6mm~=1981.2mm	92.075mm	165.1mm	165.1mm	165.1mm	165.1mm
>1981.2mm	111.125mm	165.1mm	165.1mm	165.1mm	165.1mm

LOUVRES



47mm Elliptical Louvre

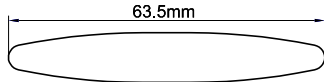

63mm Elliptical Louvre

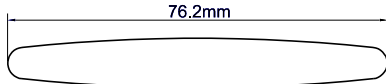

76mm Elliptical Louvre

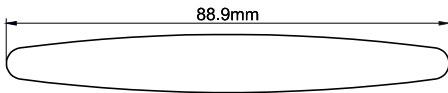

89mm Elliptical Louvre

LOUVRE DEPTH CLEARANCE

This diagram is to help determine the adequate depth inside the window opening for unobstructed louvre rotation. The figures given are measured from the back of the panel to the window.

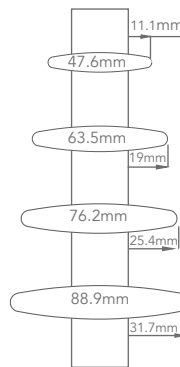

LOUVRE PIN

Louvre pins are used to ensure louvre tension. In addition a tension screw is inserted into one louvre in the panel. This is the same for all louvre sizes. Access holes are drilled in the in the stile for each panel to allow the tightening or loosening of the tension screw, to adjust the louvre tension. Please note therefore additional holes will be visible in the stiles.

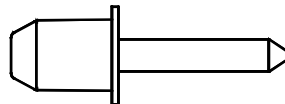

TILT RODS

Standard tilt rod

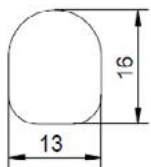

Silent tilt rod

Silent Tilt rods are integrated into the stile and are not visible. Silent tilt rods are available in 63mm, 76mm and 89mm. The 47mm does not have this option.

The Silent Tilt rod will automatically be split into 2 parts when the number of louvres connected to the silent tilt rod exceeds the following limit.

Louvre Size	Max Possible Louvres	Panel Height Range
63mm	24	1289 - 1385mm
76mm	19	1276 - 1372mm
89mm	16	1289 - 1385mm

If the louvre quantity exceeds the above limit, the gear tilt control will be equally split into halves. If the louvre quantity is odd the bottom section will have one more louvres than the top section. If the panel has a divider rail, and the louvre quantity above divider rail or below divider rail exceeds the above limit, split tilt rods are also required.

OFFSET TILT RODS

Offset tilt rods can be ordered. The standard offset is 25mm from the centre of the tilt rod to the end of louvre on hinge side. If a different offset is required please specify the position from the centre of the tilt rod to the end of the louvre on the hinge side in the short notes on the order form.

The centre of the tilt rod will be 25mm from louvre end on hinge side of the panel. For Fixed panels, the offset tilt rods will be positioned on the left side for all panels. For special shaped panels, the offset tilt rods will be on the higher side of the stile.

OFFSET TILT ROD FOR MULTI-FOLD SHUTTERS

Multi-fold panels will be made with the tilt rod offset from the centre to enable panels to be folded flat without tilt rods obstructing one another. The standard offset for the tilt rod is 7mm from the centre, i.e. tilt rod will be 7mm to the left of centre for left panels, and 7mm to the right of centre for right panels. Rebates between panels are made right over left. Bi-Fold panels (LR or LLRR) do not require offset tilt rods.

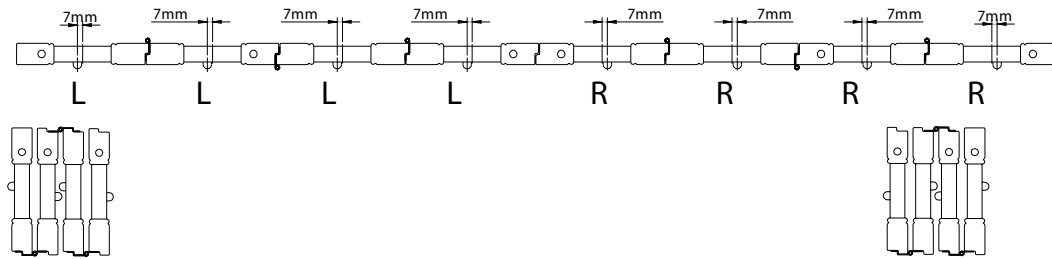

5. ROOM DARKENING SHUTTER & SHADE

[BACK TO MENU](#)

SPEC019-2023

ROOM DARKENING BLIND OPTION

DOUBLE INSERT F FRAME

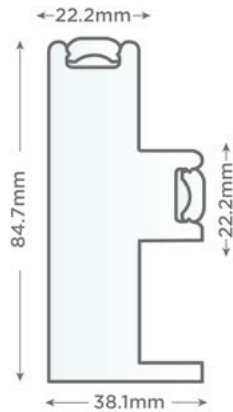

Double Insert F Frame 84mm

*NOTE: When you order Room Darkening blinds and the frame has a T post please note the defaulted specification below:

- If there is no build out with T post, then the Room Darkening blind will be defaulted to one blind sitting behind the T post.
- If there is build out with T post then the Room Darkening blind will be split according to the T post.
- For Double Insert F Frame 84mm, holes for screws will be predrilled. For inside mount, 63.5mm will be supplied and screw hole predrilled under the side insert. For outside mount, 76.2mm screw will be supplied and screw hole predrilled under the front insert. For orders not specified the mount type, no screw holes will be predrilled but 76mm screw will be supplied.

2. Frame mounting:

Outside Mount

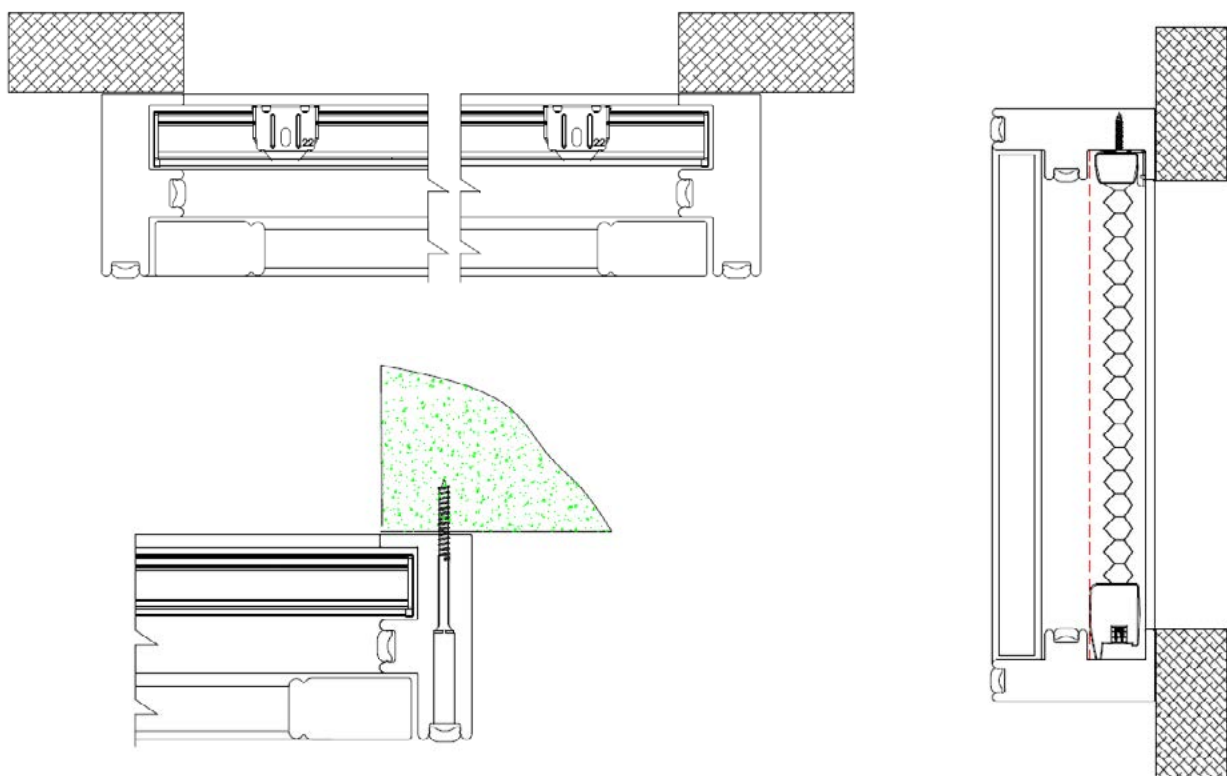

©S:CRAFT Copyright in this material belongs to S:CRAFT and copying or reproduction in whole or in part We reserve the right to alter specifications without prior notice.

INSIDE MOUNT

Will require a minimum depth clearance 30mm. If it is a bay window inside mount, the top and bottom cover strips will be cut flush on both ends, their length = each section frame outer dimension + 50mm

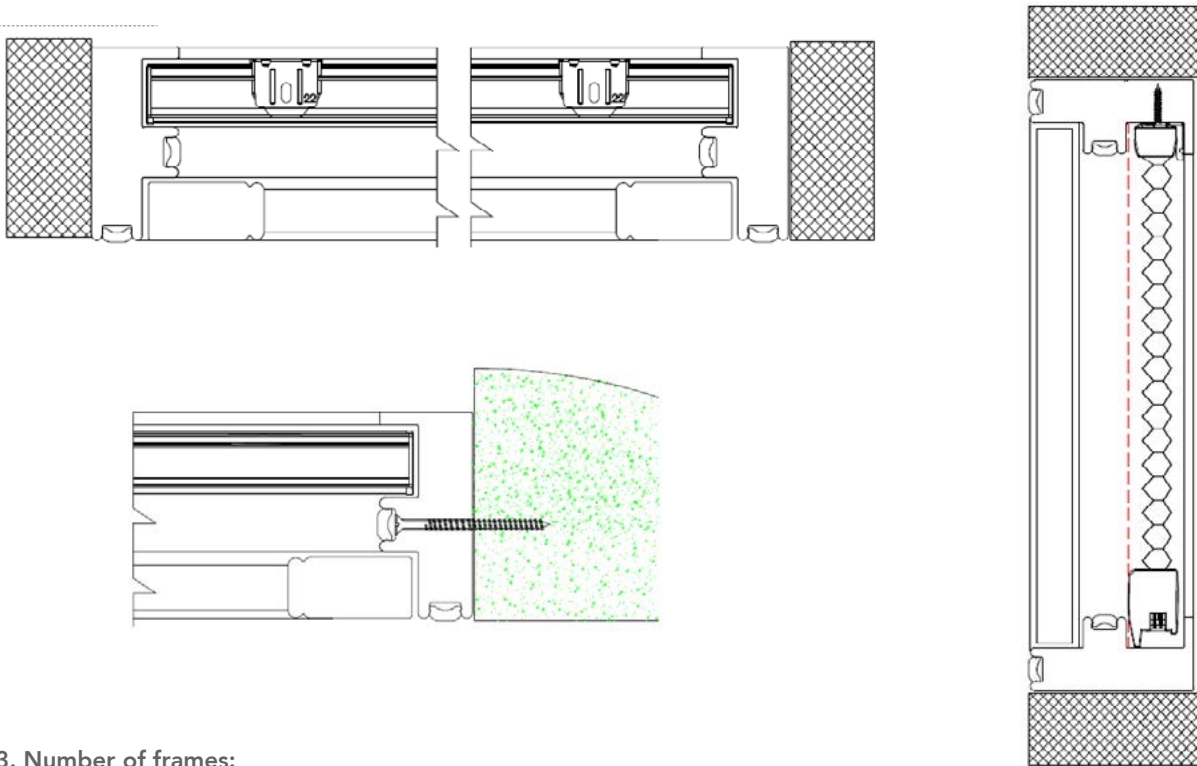

3. Number of frames:

3 sided (top, left & right) and 4 sided.

4. Available shutters:

All rectangular shutters only.

5. Available cellular shade:

25mm Single Cell, Fabric type: Room Darkening

- System: Smartfit Bottom Up (cordless)



6. Size limit for cordless shade:

	Min. Size	Max. Size	Max. Area
Width	220mm	1800mm	4.3m ²
Drop	150mm	2438mm	4.3m ²

* The above chart does not mean that a shade can be ordered in maximum width and maximum height.

* The shade width and drop must be within the size limitations above and not exceed max area.

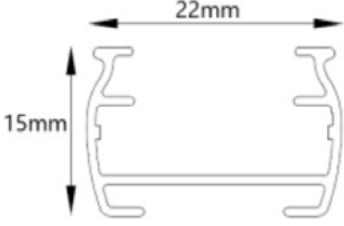
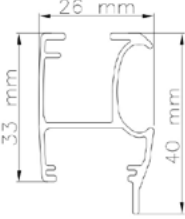
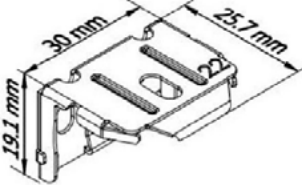
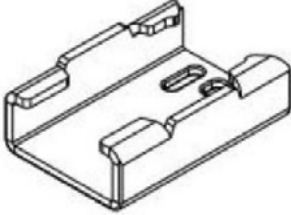
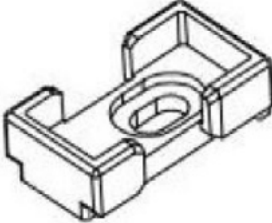
MAIN COMPONENTS FOR SMARTFIT BOTTOM UP SHADE

Item	Drawing	Notes
Headrail		
Bottom Rail		No Handle
Installation Bracket		
Cord Equalizer Housing Cover		
Cord Equalizer House Base		Clear Plastic
Fiberglass Pole		Length 762mm Black One provides with each order as standard

If there is a T-Post, Corner/ Bay post, it will be made as below:

1. If the shade behind is for one whole piece, the post and frame will be jointed as picture below:

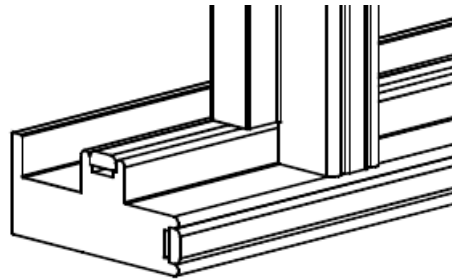

Double Insert F Frame
84mm

2. If the shade behind is divided into several pieces by the T-Post , Corner/ Bay post, then T-post, Corner/ Bay post need to add 38.3mm (Double Insert F frame 84mm) build out at back for the standard frame depth. See picture below:

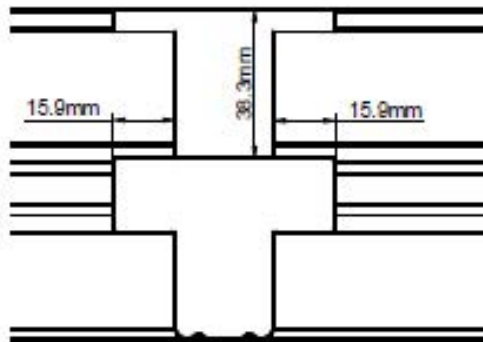

Double Insert F Frame
84mm

For Corner/ bay post, take Double Insert F frame 84mm frame as example:

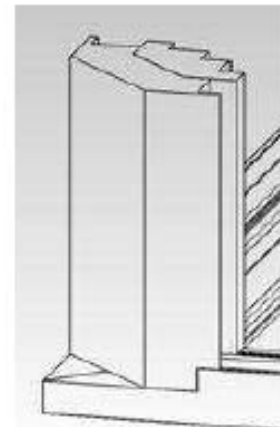
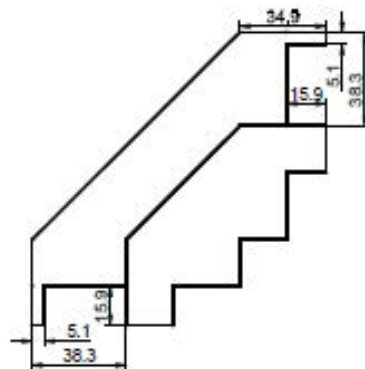
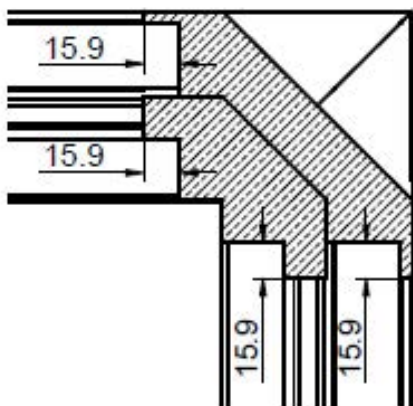

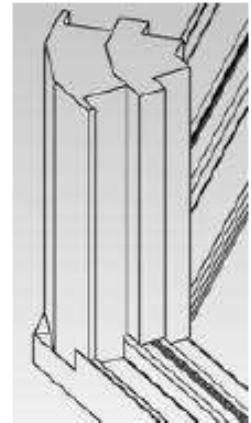
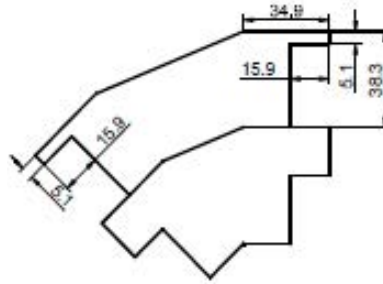
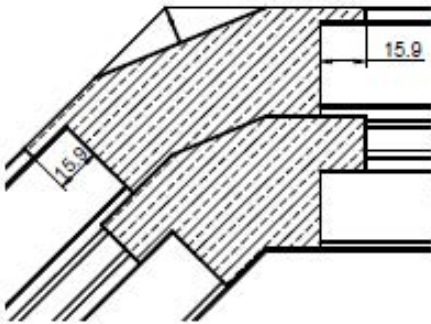

3. For Double Insert Frame 84mm with T-Post , the insert for the Double Insert F Frame 84mm will be cut at the bottom of the posts and there is a 3mm overlap between insert and post. See picture below:

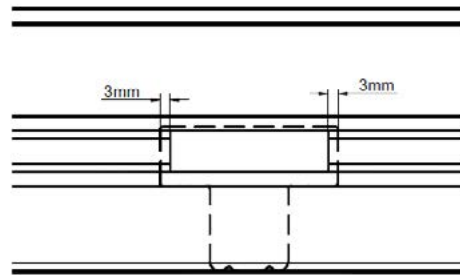
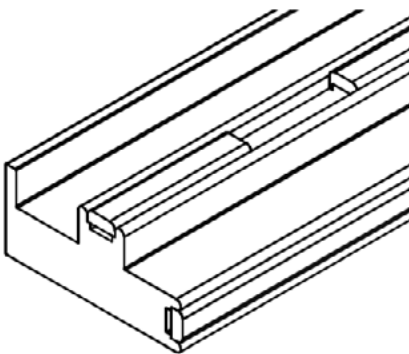

ROOM DARKENING BLIND COLOURS (25MM PLEAT)



ROOM DARKENING COLOUR COORDINATION CHART

Please note, the below three colours (highlighted red) will be discontinued in February 2023.

No.	Fabric	Fabric Color Code	Fabric Color Name	Rail Color	End Cap	Headrail Top Cover	"SmartFit Bottom Up Cord Color"	Installation Bracket Color/Cord Equalizer Housing Cover/
1	Room Darkening	C4510	Brie	"3094 Cottage White"	"2094 Cottage White"	2021 Cloud Cream	T001 White	3579 Nature
2	Room Darkening	C4508	Sand	3094 Cottage White	2094 Cottage White	2021 Cloud Cream	T001 White	3579 Nature
3	Room Darkening	C4504	Desert	3334 Terra	2334 Terra	2334 Terra	T001 White	3578 Sahara
4	Room Darkening	C4506	Primrose	3094 Cottage White	2094 Cottage White	2021 Cloud Cream	T001 White	3579 Nature
5	Room Darkening	C4507	Tamarind	3579 Nature	2579 Nature	2584 Moonbeam	T001 White	3579 Nature
6	Room Darkening	C4201	Black Ink	3212 Black Ink	2212 Black Ink	2208 Black	T201 Black	3212 Black Ink
7	Room Darkening	C4105	Dusk	3129 Silver	2129 Silver	2129 Silver	5107 Silver	3107 Silver
8	Room Darkening	C4103	Mineral	3129 Silver	2129 Silver	2129 Silver	5107 Silver	3107 Silver
9	Room Darkening	C4509	Pebble	3578 Sahara	2578 Sahara	2583 Warm Sand	T001 White	3578 Sahara
10	Room Darkening	C4704	Indigo	3716 Indigo	2716 Indigo	2716 Indigo	T001 White	3716 Indigo
11	Room Darkening	C4601	Fog Green	3613 Celery	2613 Celery	2615 Fog Green	T001 White	3579 Nature
12	Room Darkening	C4104	Slate	3715 Agave	2715 Agave	2715 Agave	T001 White	3715 Agave
13	Room Darkening	C4102	Terra	3334 Terra	2334 Terra	2334 Terra	T001 White	3578 Sahara
14	Room Darkening	C4802	Larkspur	3475 Plum Purple	"2475 Plum Purple"	2475 Plum Purple	T001 White	3475 Plum Purple
15	Room Darkening	C4705	Topaz	3722 Sky	2722 Sky	2722 Sky	T001 White	3722 Sky
16	Room Darkening	C4001	Glacier White	3058 White	2058 White	2052 Day Light	T001 White	3058 White
17	Room Darkening	C4108	Infinity	3716 Indigo	2716 Indigo	2716 Indigo	T001 White	3716 Indigo
18	Room Darkening	C4412	Ecru	3579 Nature	2579 Nature	2584 Moonbeam	T001 White	3579 Nature

6. HARDWARE

Hinges:

Self-Mortice hinges are provided They are pre-mounted on panels and frames by two screws in the slotted holes. The screw for the third rest hole should be installed at installation. The hinge pins are removable.

Hinge Colours
Antique Brass, Bisque, Black, Bright Brass, Brown Grey, Brushed Nickel-Plated, Crisp Linen, Nickel-Plated, Pearl, Pure White, Sea Mist, Stainless Steel, Stone Grey, String, Taupe Grey, White

For the CUBA program

Panel height	No. of hinges
<=1219.2mm	2
1219.2mm~1981.2mm	3
1981.2mm~2438.4mm	4
2438.4mm~3048mm	5
>3048mm	6

Please Note:
Centre of hinge to top/bottom of panel is 76mm.

MAGNETS

Round magnets are pre-mounted on the panels and the catch is pre-mounted on the frame when the order is 'OD' type. An 'L magnet catch' is included in the hardware box when ordering 'OP' type.



CATCHPLATE

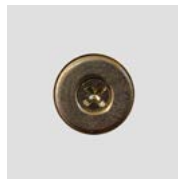

MAGNET

HANDLE OPTIONS

Handle A and B are available to order in Nickle Plated only. Please specify the handle you require along with the quantity on the notes section of your order card, they will not be pre installed but supplied loose in the hardware box. (Surcharge will apply).



Handle A

Handle B

HOFFMAN KEYS

These are supplied and are used to join frame corners together.



PANEL FEET

Panel feet are mounted on the bottom of panels.

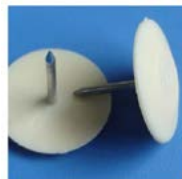

L SHAPE MAGNET CATCH

When ordering 3 sides frames with the gap more than 2.5mm, we will supply L shape magnet catch.



SIDE MAGNETS

This option is available in the order card and when selected we will add a magnet situated to the side of stile (1). It can be selected where a Left and Right panel meet where there is no lightblock or bottom frame to secure the panels. The magnets will act to keep the panels together.

Side magnets are available for butt, rebate and D-Mould stile, not available for the Java product.



(1) Magnet shown in side of stile



(2) Magnet keeping panels together

The side magnet can be selected where you have:

- a) Door shutters that require bottom clearance.
- b) Tier on Tier shutters without horizontal T post. The side magnet will be installed on the top of the bottom tier and the bottom of the top tier (3).
- c) Café style shutters with upside down goal post frame (4).
- d) Window that do not have a light block or bottom frame (5).

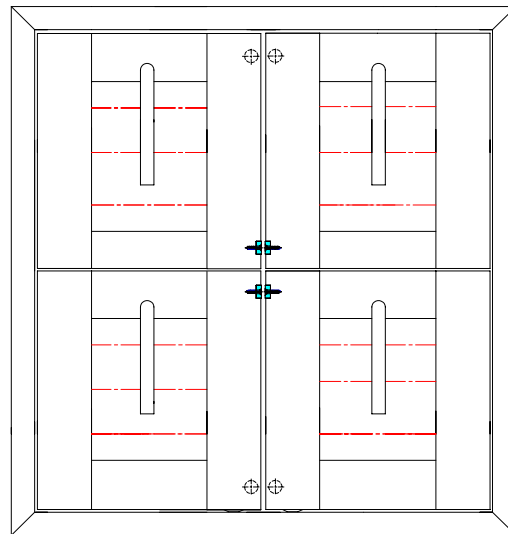

(3) Double Hung shutter without horizontal T post

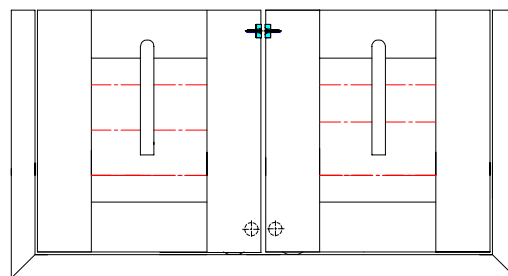

(4) Café Shutter

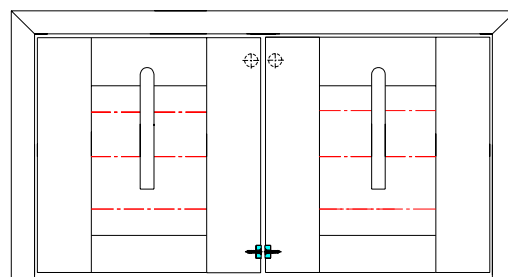

(5) No frame or light block on either top or bottom

BOLTS & RING PULL

[BACK TO MENU](#)



1. Barrel Bolt

Can be used for hinged shutter and Bi-fold track shutter to fit for panels. Based on the size of the bolt, 41.3mm stile cannot be used for this product.

Colours available are Brushed Nickel, Pure White, Pearl, and Black

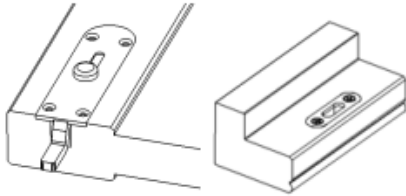

2. Key Lock

Can only be used for hinged shutter. Based on the size of the security bolt, 41.3mm stile cannot be used for this product. Please note you will need to note the location of the key lock in the notes section of the order card.

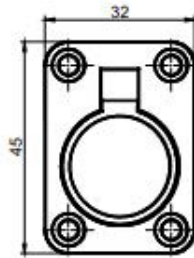

3. Ring Pull

Can be used for hinged shutter and track shutter. Based on the size of the ring pull, 41.3mm stile cannot be used for this product. The location of the ring pull, refer to the bolt location.

RING PULL & BARREL BOLT

LL

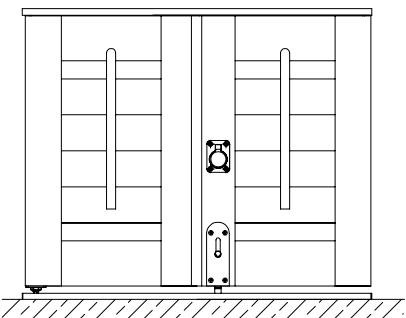

RR

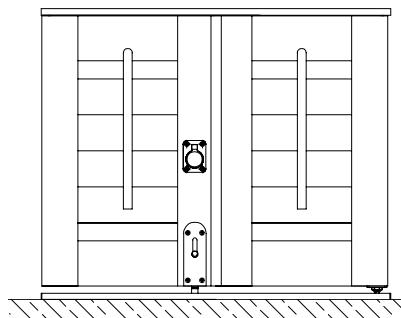

LLL

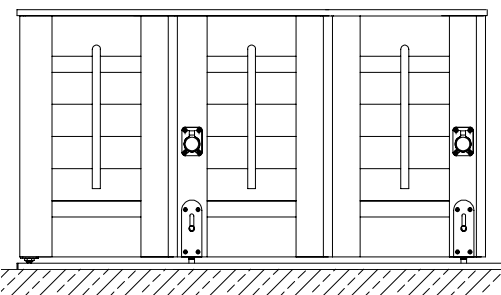

RRR

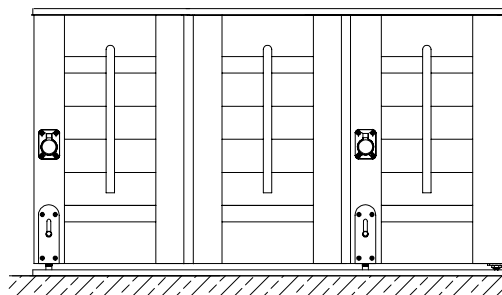

LLRR

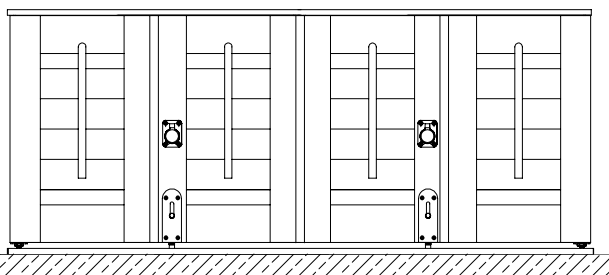

LLL

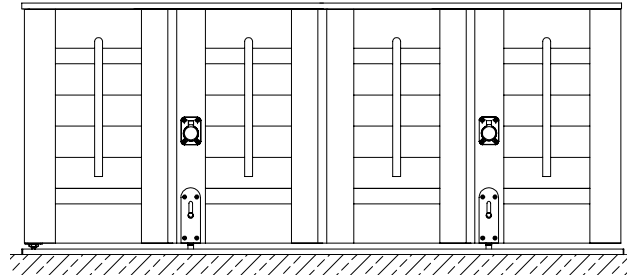

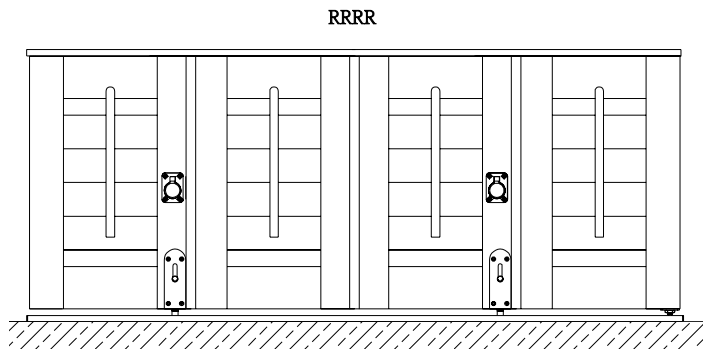

The bolt location for both track system shutters and regular shutters would be the same. The general principle is that the bolt position will avoid the stile which will install the spring-loaded guide at bottom (same stile as the Wheel carrier).

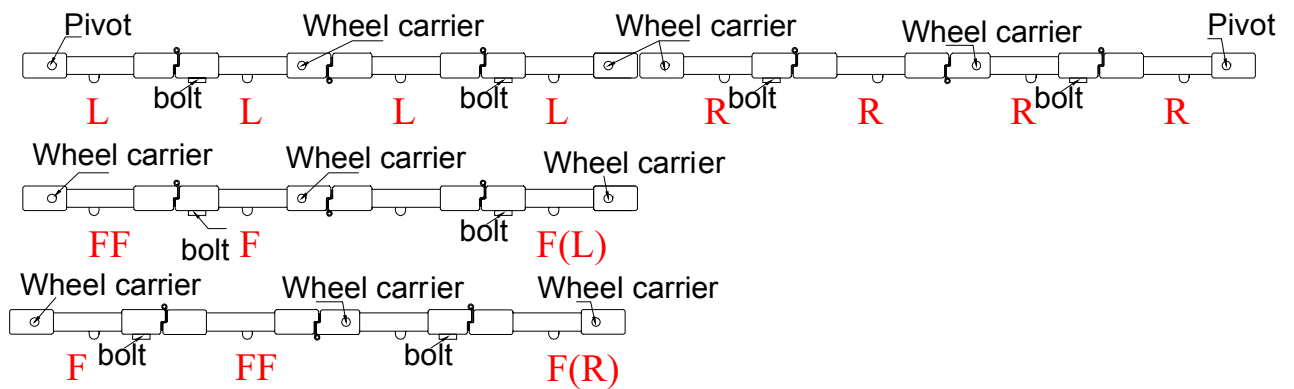

Ring pull: for easy opening and closing (Not available for 41.3mm stiles)

Ring Pull and Barrel Bolt: Customer needs to specify ring pull location on the order form. Ring pull location principle for Floating Panels: (same as the location of 90° Bifold Track)

1. When floating panel config is in pairs, it will be split into halves, the left will be for LL and the right will be for RR. So the ring pull location for FF/FF, FF/FF/FF/FF will be same as that of panel config as LL/RR, LL/LL/RR/RR.
2. When floating panel config is FF, the ring pull location will be same as that of panel config LL.
3. When floating panel config is singular, it will be split into 3 sections, the left and mid sections are for LL and the right section is for RR. So the ring pull location for FF/FF/FF, FF/FF/FF/FF/FF will be same as that of LL/LL/RR, LL/LL/LL/RR/RR.

Please note the ring pull finish will match with the hinge finish.

Please see the matching chart below:

Hinge	Pure White	White	Bisque	Pearl	Black	Nickel Plated	Brushed Nickel	Antique Brass	Bright Brass	Stainless Steel
Ring Pull	White	White	Bisque	Pearl	Black	Brushed Nickel	Brushed Nickel	Antique Brass	Bright Brass	Brushed Nickel

Hinge	Crisp Linen	String	Sea Mist	Stone Grey	Brown Grey	Taupe Grey
Ring Pull	Bisque	Bisque	Brushed Nickel	Brushed Nickel	Brushed Nickel	Brushed Nickel

Please refer to the colour coordination chart on page 5 to check the hinge colours available for the Cuba range. Position: For different panel configuration, please refer to the location of bolt to show on which stile the pull will be fixed.

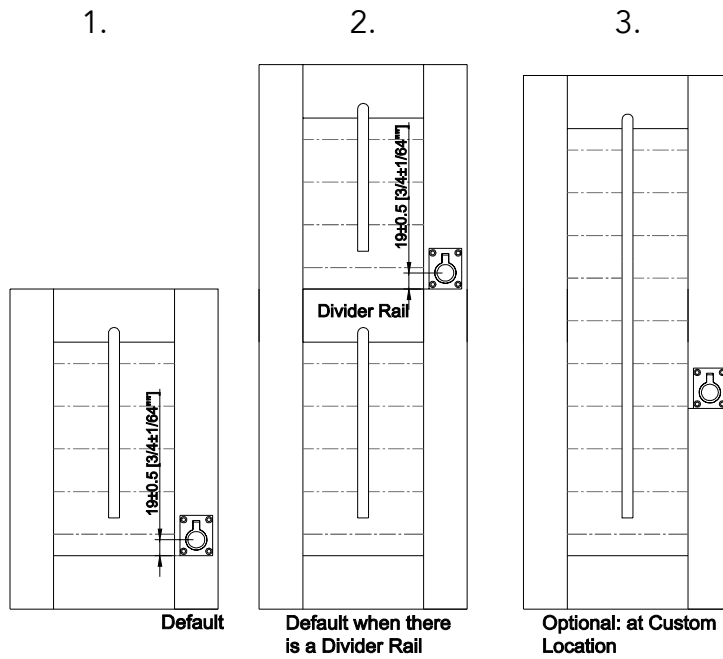

Position:

1. Above Bottom Rail (Default)
2. Above 1st Divider Rail (Default when there are Divider Rails)
3. Custom Location

If both bolt & ring pull are specified, the distance between them is 2 3/4" (70mm), and the ring pull location is 6 3/4" (170mm) from the bottom of panel.

When there is no mid rail, ring pull will be just on the top of Bolt (2 3/4" /70mm above bolt) as default location; if there are mid rails, bottom of ring pull lines up with top of the 1st mid rail as default location.

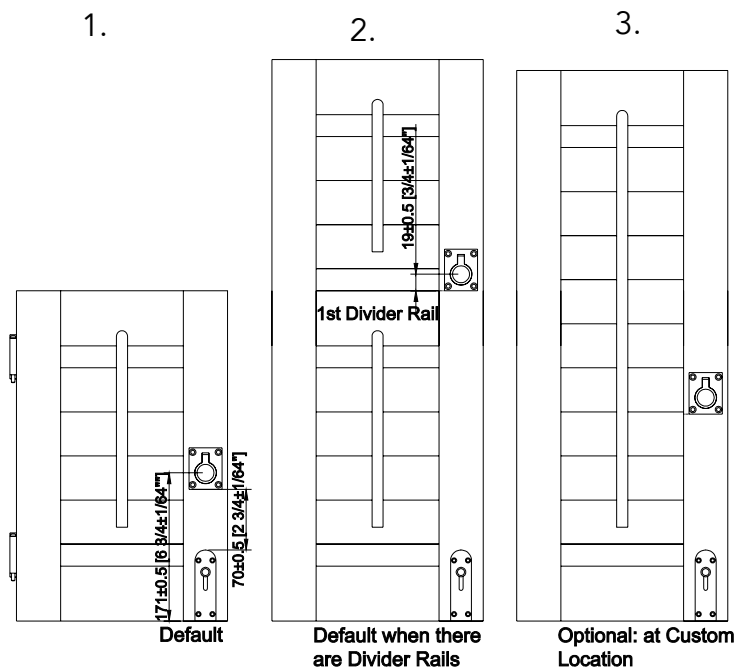

Position:

1. 2 3/4" (70mm) Above bolt (Default when both Ring Pull and bolt are specified)
2. Above 1st Divider Rail (Default when there are Divider Rails)
3. Custom Location

Measurements:

Window size: Measure from the bottom of the window to the centre of the ring pull

Max frame-to-frame: Measure from the bottom of the frame to the centre of the ring pull

PANEL CONFIGURATIONS

If you order shutters in OVERALL PANEL SIZE & OD OF FRAME, panel configuration is required. Please specify if the stile type required is Rebate or D-Mould.

1 panel: L/R



2 panels: LL/RR/LR

A) Rebate stile

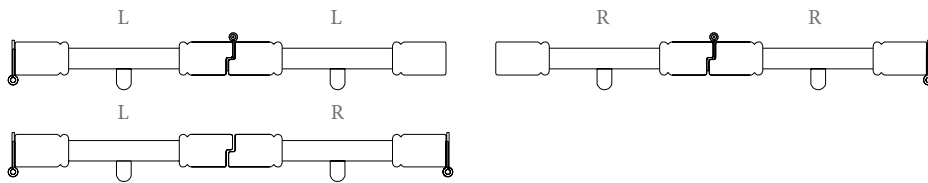

B) D-Mould stile

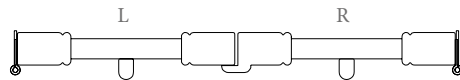

3 panels: LLR/LRR

A) Rebate stile

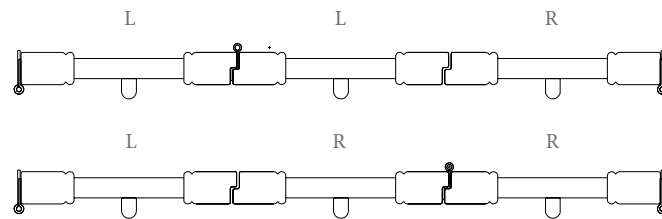

B) D-Mould stile

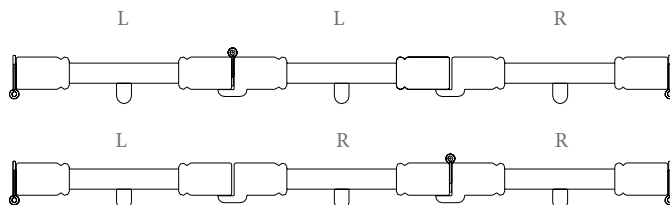

4 panels: LLRR

A) Rebate stile

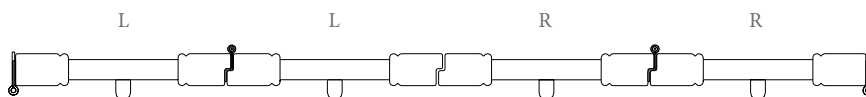

B) D-Mould stile

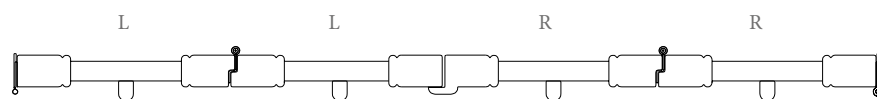

Offset tilt rod for multi-fold shutters

For multi-fold panels, we will place the tilt rod offset from the centre. By doing so, panels can be folded flat without tilt rods obstructing each other. The standard offset for the tilt rod is 7mm from the centre, i.e. tilt rod will be 7mm to the left from the centre for the left panels, and 7mm to the right from the centre for the right panels. Besides, the Rebate is made with right panels over left ones for both the panels folded to left and to right.

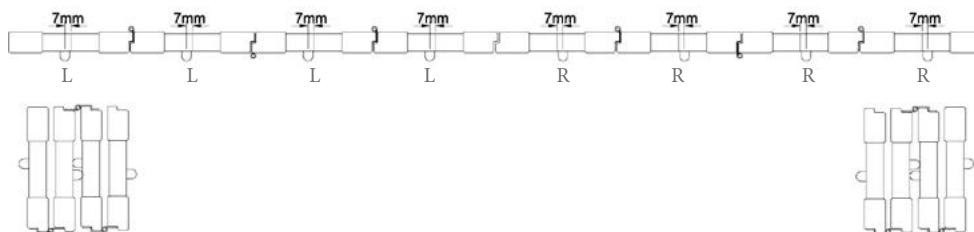

* For 2 panels (LL/RR) and 4 panels configuration (LLRR), there is no need to offset the tilt rod.

PANEL SIZE LIMITATIONS

Panel structure

The S:CRAFT shutter panel is made up of several parts. To help you understand the panel construction please see photograph.

MOUSE HOLE

STILE

TILT ROD

LOUVRE

RAIL

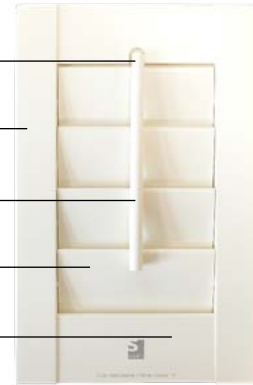

Louvre Size	Width				Height		
	Minimum	Maximum			Minimum	Maximum	Mid rail Required if
		Single hung	Bi-fold hinged shutter/ Multi-fold with Top and Bottom track	Multi-fold hinged shutters & multi-fold with Top track only			
47mm	152mm	750mm	660mm	550mm (No. of panels ≤ 4)	250mm	3000mm	H>1981mm
63mm	152mm	890mm			250mm	3000mm	H>1981mm
76mm	152mm	890mm			250mm	3000mm	H>1981mm
89mm	152mm	890mm			250mm	3000mm	H>1981mm

NB: Where the panel size limits above are exceeded, warranty on the order line is waived automatically.

NB: When a single hung panel width is less than 228.6mm and used with the following frames: Deco, L, Z and Hang Strip, the stile opposite to the hinge will be rebated.

If panel height is over 1981mm, a Mid Rail is required and if the panel has a Mid Rail but the height from the centre of the Mid Rail to the top of the top rail or to the bottom of bottom rail is still over 1981mm, another Mid Rail will be required.

If you do not specify the Mid Rail location, the order will be held to confirm if a Mid Rail is required. However, if you specify no Mid Rail, you will waive your warranty and manufacture will proceed as per your instructions.

Shutter used for door without bottom support:

In situations where shutters are used for door applications, which do not have any support underneath the panels, the customers must inform S:CRAFT when placing this type of order. (See the following specs for Shutters used in Door applications)

Please note:

- (1) The factory will add extra hinges to support the panels.
- (2) Bigger and Stronger Top and Bottom rails will be added to reduce the probability of the panels sagging and increase shutter intensity.
- (3) If customers fail to notify S:CRAFT that the shutter will be used in door applications, the customers will be responsible for the cost of the any re-order that is submitted.

Please see the following chart for details.

Panel Configuration	
L,R,LR	LL, RR, LLRR
Manufactured with warranty	Must order it with track, or waive warranty.

PANEL WEIGHT

Panel Weight		
Material	Louvre size	Weight (kg)/m ²
Cuba	47mm	7.80
	63.5 mm	7.31
	76.2 mm	TBA
	88.9 mm	7.88

* Average Weight

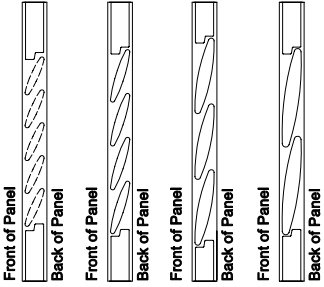
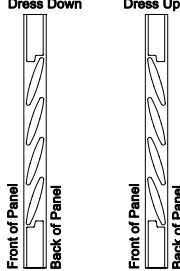
FIXED LOUVRE OPTIONS	
	Fixed Closed Position Fixed Open Position
<p>Available in two positions: closed or open at angle.</p> <p>Available in four louvre sizes: 47mm, 63mm, 76mm. and 89mm</p>	 
<p>The standard default orientation for Fixed louvres is Closed 'Dress Down' with the bottom edge of louvres to the front of the panel. 'Dress Up' option is also available if specified on the order form.</p> <p>NB. Note that normal orientation for adjustable louvres when closed is in the 'Dress Up' state.</p>	

NB: Fixed louvres closed Dress Down and fixed louvres opened as Dress Down are not available for specialty shutters with the exception of French Door Cutout Type A, B, C, and D without fixed louvres.

7. SIZING AND MEASURING

ORDER SIZE DEFINITION

Overall Panel size (OP):

The size given is the overall panel size. The width does not include the hinge space from panel to batten on the left & right side, but does include the gap between panels, the standard gap is 2mm between panels and we will calculate the single panel width based on this measurement (see diagram below). The height given must be net panel height. We will pre-mount the hinges and the magnets and include panel feet and L shape magnet catches in a hardware box. The stile can be Rebate or D-mould, please specify in the relevant section of the order form.

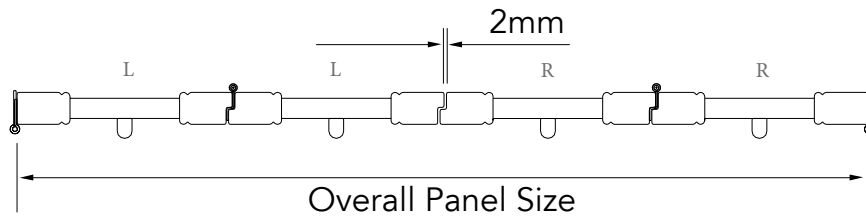

OD of frame:

Size given is "Outside Dimension" of the shutter; we will pre-mount the hinges and the magnets (ball magnets), and will include all the necessary hardware in a hardware box. The stiles can be Rebate and D-Mould stile, please specify on the order form.



Camber Deco Frame 50mm: Can only be ordered as outside mount, the size given must be OD of frame size.

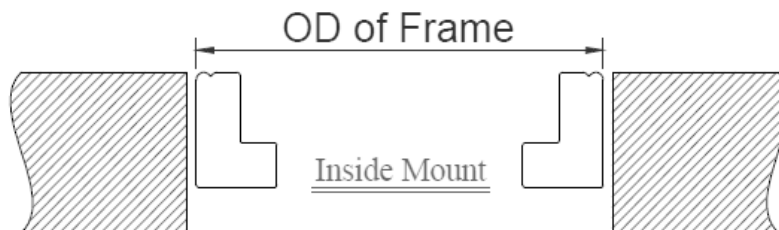

"Z" frame: Can only be ordered as inside mount, the size given must be OD of frame size. (Backside of Z frame, refer to the drawings).

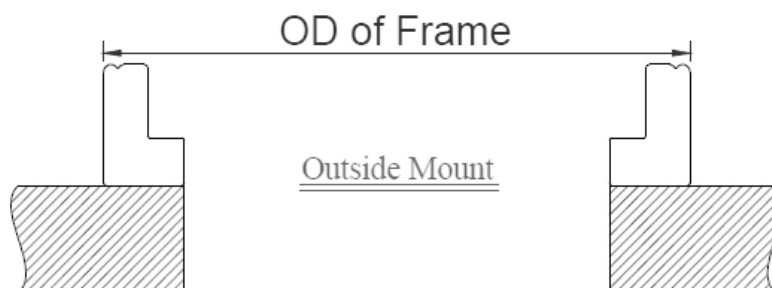

"L" frame: Can be ordered as inside mount and outside mount, size given must be OD of frame size.

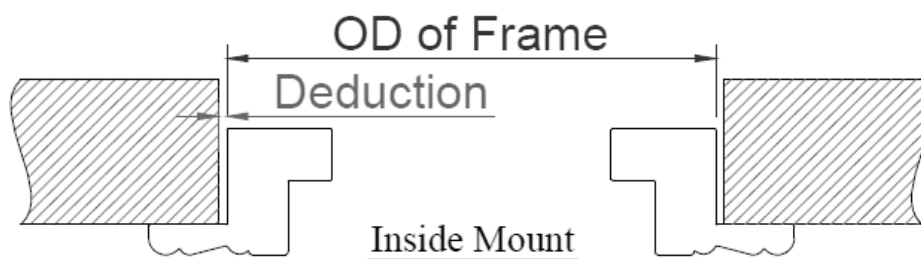

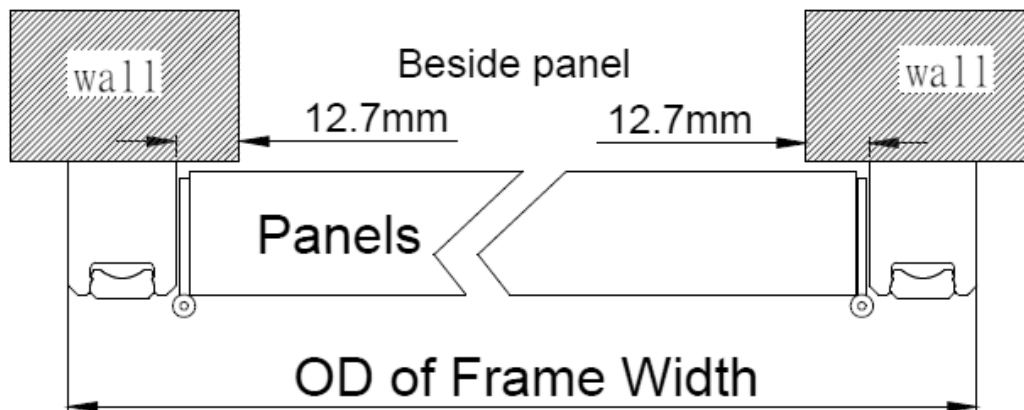

TOLERANCES

Width: The width of the panel can be plus or minus 1.6mm from the order width.

Height: The height of the panels can be plus or minus 1.6mm from the order height.

Mid Rail location: Mid Rail location may be off by half a louvre space. Measure from bottom of bottom frame to centre of Mid Rail if order OD of frame, and from bottom of panel to centre of Mid Rail if order net panel size or overall panel size.

For 47mm louvre can be off by +/-19mm.

For 63mm louvre can be off by +/-25mm.

For 76mm louvre can be off by +/-32mm.

For 89mm louvre can be off by +/-38mm.

MOUNTING TYPE

Café style shutter: Please specify on the order form if the shutter is a café style. We will finish the top of the panels and one end of the battens.

If a café shutter is required with a 3 sided frame, it should be 3 sides inverted.

Tier on Tier: The standard gap between the top tier and bottom tier is 2.5mm.

Full height: Regular shutters running the full height of a window.

CLEANING RECOMMENDATIONS

Use a clean, dry feather duster, cloth or vacuum with a brush attachment to gently remove dust and debris. To ensure thorough cleaning, wipe the louvres in the open and closed positions. Do not immerse the product in water or use abrasive chemical solvents. This may cause discolouration and the wood to warp. Ultrasonic cleaning is not recommended. For best results on Antigua shutters use a cotton cloth dampened with water. Polyester cloths tend to create static, which can attract dust.

8. WARRANTY, SHUTTER AND SHADE

S:CRAFT honeycomb blinds on shutter and shade are backed by a warranty up to 3 years, starting from the shipping date of the order. The warranty covers original defects in material or workmanship, the following conditions apply:

Covered	Not Covered
<ul style="list-style-type: none"> • All internal hardware including components and brackets are covered depends on material type (for stainless steel: 3 years, for non-stainless steel: 2 years) • Repairs / Remake will be only with like or similar parts or products • Fabric delamination • Operational Cords: 3 years 	<ul style="list-style-type: none"> • Any damage caused by unauthorised repairs, modified or improper installation, cleaning, maintenance • Accidents, alterations, misuse, abuse to the product • Exposure to elements (sun, wind, water/moisture), and fading or discolouration over time) • Shipping charges, any removal and reinstallation related cost • Any conditions caused by normal wear and tear

FABRIC DISCLAIMERS

Due to the nature of the weaving process, some imperfection in the weave is considered normal. Fabric appearance can vary based on the indoor light intensity. Railroaded fabrics may curl along the edge. This is not a defect and is considered normal. Due to variations in fabric and dye lots, colours or sheens may vary slightly. It is recommended that all shades for the same room be ordered at the same time to help ensure colour consistency.

Natural shades may have variations and visual inconsistencies in colour, grain and texture. They may also crack or split, twist or bow, shrink or stretch, and change colour over time due to aging, and texture, directly sunlight or other climatic conditions. These unique characteristics are inherent in natural materials and are not considered defects in material or workmanship. Exact colour matches cannot be guaranteed.

8. WARRANTY, EDR & CANCELLATIONS

WARRANTY

S:CRAFT warrant that our shutters will be free from defects in materials or workmanship for as long as the original purchaser owns the shutters provided that such products were properly installed; and such products were made or assembled exclusively from original materials and components. Any resale or other transfer of the product and/or materials voids this warranty.

This warranty is exclusive and in lieu of all other obligations, liabilities or warranties. In no event shall S:CRAFT be liable for incidental or consequential damages, or for any expense associated with such damages. Repair or remakes of defective products is the sole remedy under this warranty and in no event shall S:CRAFT be liable for costs to remove and/or reinstall the product. Repairs will be made only with like or similar parts. This warranty does not include shipping charges or the cost of labour involved for measuring and installation.

This warranty does not cover any condition of or damage to the shutter or window, from unauthorized repairs, accidents, alterations, misuse, abuse, act of God, motorized devices, wear and tear or failure to follow our instructions with respect to measurement, installations, cleaning or maintenance. Improper, inappropriate, or unauthorized replacement parts, repairs or maintenance voids this warranty. This warranty excludes all liability for removal of the shutter and reinstallation in the same or another window, or damage to the window frame, glass or any other portion of the window. Due to natural variations in colour, grain and texture of the raw materials S:CRAFT is not able to guarantee exact matches on subsequent orders. Returns cannot be authorized due to these normal variations.

All other warranties, both express and implied, are expressly disclaimed. This warranty excludes all liability for consequential or incidental damages for any cause whatsoever.

Colour Fastness:	3 years
Structure:	3 years
Hardware:	1 year
Stainless Steel Hardware:	3 years

MODIFICATIONS AND CANCELLATIONS

Since our products are made to measure based on specifications supplied by customers on our original order form, no cancellations can be accepted. Once an order is submitted, customers are liable for the full value of the order.

Product changes will only be allowed prior to production. This is usually within 3 hours of the order being received at the factory. Once orders are in production, no changes can be made and liability for the full value of the order lies with the customer.

EDR FORM AND CANCELLATIONS

EDR forms are obtainable from Customer Services and are required where damage has occurred and in situations where a part or complete replacement shutter is required.

On receipt of the form, please complete it in full and send back to Customer Services, with digital photo stills, confirming the fault.

Please see examples and requirements to accompany EDR form below:

- 1) If your shutters are damaged on arrival – please take digital stills of outer packaging.
- 2) Warped panels – panels must be placed on a flat surface and digital still must clearly show the warp on this surface in particular the corners where the panel doesn't make contact
- 3) Incorrect sizes – if the panels don't fit, each individual panel must be measured and inner frame size measured whilst in situ, these measurements should be sent to Customer Services.
- 4) Cancellations/Amendments – Once the order has been confirmed there is a very small time gap between factory receiving order and proceeding with subsequent manufacture of that order. It is therefore essential that you contact Customer Services as soon as possible. We will then endeavour to ascertain whether the order has been processed or if it is possible to stop it. S:CRAFT cannot be held liable for any costs should the order have been processed.

1. Definitions
 - 1.1 'Buyer' means the person or company who buys or agrees to buy the Goods from the Seller.
 - 1.2 'Conditions' means the Terms and Conditions set out in this document and any other terms agreed in writing by the Seller.
 - 1.3 'Contract' means the agreement between the Seller and the Buyer for the sale and purchase of the Goods and/or Services incorporating these Conditions, the Order Confirmation and any other terms agreed in writing by the Seller.
 - 1.4 'Goods' means the articles which the Buyer agrees to buy from the Seller as set out in the Order Confirmation.
 - 1.5 'Order Confirmation' means the written confirmation of the Seller in response to an order for Goods and/or Services placed by the Buyer.
 - 1.6 'Seller' means ShutterCraft Ltd trading as S:CRAFT.
 - 1.7 'Services' means any services which the Seller is to perform for the Buyer as set out in the Order Confirmation.
2. Conditions Applicable
 - 2.1 These Conditions shall apply to all Contracts between the Seller and the Buyer to the exclusion of all other terms and conditions unless expressly agreed in writing by the Seller.
 - 2.2 All orders for Goods and/or Services shall be deemed to be an offer by the Buyer to purchase Goods and/or Services pursuant to these Conditions. Acceptance of the offer shall occur when the Seller sends an Order Confirmation to the Buyer (or otherwise on delivery of the Goods or performance of the Services) and a Contract shall come into being.
3. Price and Payment
 - 3.1 The price shall be the Seller's quoted price for the Goods as quoted on the Order Confirmation or invoice and subject to any agreed discounts.
 - 3.2 The price is exclusive of VAT which shall be due at the rate ruling on the date of the Seller's invoice.
 - 3.3 The Seller reserves the right to change prices from those published at any time without prior notice.
 - 3.4 Payments unless otherwise stated by the Seller shall be payable by the Buyer 14 days from the date of invoice unless otherwise agreed in writing by the Seller. Time for payment shall be of the essence. The Seller reserves the right at any time to request cash on order in relation to any future orders of Goods. Any extended credit terms must be in writing and signed by a director of the Seller to be valid and shall be subject to the following provisions;
 - 3.4.1 Any credit levels shall be based on such factors as may be decided by the Seller in its absolute discretion and which may include volume purchase levels and historical payment periods taken by the Buyer to settle invoices, credit history and the Buyer hereby confirms that the Seller may seek and obtain a credit report from third party providers for this purpose or request the Buyer to obtain a credit reference from its bank or other third party and to answer all reasonable enquiries relating to credit as requested by the Seller.
 - 3.4.2 The Seller reserves the right in its absolute discretion and for any reason to change or cancel the Buyer's credit levels at any time without prior notice and without any liability to the Buyer.
 - 3.4.3 The Seller reserves the right to provide any credit terms on an order by order basis.
 - 3.4.4 Previous credit levels or terms provided by the Seller to the Buyer do not place any obligation upon the Seller to continue to provide the same level of credit or to provide any credit at all.
 - 3.5 The Seller reserves the right to charge interest on all overdue accounts at the rate set out in Late Payment of Commercial Debts (Interest) Act 1998.
 - 3.6 Such interest being deemed to accrue on a day-to-day basis from the date payment becomes due until receipt of cleared funds in full settlement.
 - 3.7 Payments that are returned to the Seller from the Buyer's bank for whatever reason will incur an administration fee of £30 per transaction which shall be payable by the Buyer in addition.
 - 3.8 The cost of any legal correspondence sent to the Buyer from the Seller and other legal expenses incurred by the Seller in pursuing any non payment will be added to the Buyer's total outstanding balance and shall be payable by the Buyer on a full indemnity basis.
 - 3.9 Express delivery, special freight, excess storage and carriage charges will be payable in addition by the Buyer and shall be charged on the invoice as quoted on the Order Confirmation, or as advised by the Seller to the Buyer.
 - 3.10 In the unlikely event that the Seller is asked by the Buyer to provide a quotation the quotation will be valid for 7 days only.
- 3.11 The Seller reserves the right to increase the price as set out in the quotation or Order Confirmation in line with exchange rate changes or to reflect any increase in the delivery and shipping charges imposed by third party couriers or as a result of an increase in fuel costs, and shall notify the Buyer of such increases which shall be payable in addition by the Buyer.
4. Retention of title
 - 4.1 Risk in the Goods supplied to the Buyer by the Seller shall pass on delivery.
 - 4.2 Notwithstanding delivery and the passing of risk in the Goods, or any other provision of these Conditions, legal and beneficial ownership and the property in the Goods shall not pass to the Buyer until such time as the Goods and any and all monies owed by the Buyer to the Seller have been paid for in full.
 - 4.3 Until such time as the property in the Goods passes to the Buyer:
 - 4.3.1 the Buyer shall hold the Goods as the Seller's fiduciary agent and bailee, and shall keep the Goods separate from those of the Buyer and third parties and properly stored, protected and insured and identified as the Seller's property, but the Buyer may resell or use the Goods in the ordinary course of its business, all proceeds of sale shall be held in trust for the Seller and shall be used to pay all sums due to the Seller for the Goods.
 - 4.3.2 provided the Goods are still in existence, the Seller may at any time require the Buyer to deliver up the Goods to the Seller and, if the Buyer fails to do so forthwith, enter on any premises of the Buyer or any third party including the Buyer's customers and end users where the Goods are stored and repossess the Goods and the Buyer shall ensure that in any contract or agreement it has with its customers it shall reserve such right to the Seller to repossess the Goods, and on request the Buyer shall supply contact details of its customers to enable the Seller to exercise its rights under this clause.
 - 4.3.3 The Buyer shall not pledge, create a lien over or in any way charge by way of security for any indebtedness any of the Goods which remain the property of the Seller, but if the Buyer does so all monies owing by the Buyer to the Seller shall (without limiting any other right or remedy of the Seller) forthwith become due and payable.
5. Made to measure orders
 - 5.1 If the Contract is for bespoke Goods manufactured according to measurements provided by the Buyer then the following provisions shall apply.
 - 5.2 The Seller manufactures to specific tolerances as determined by the nature of the product and specified within the Seller's published specifications for such Goods only. All orders accepted by the Seller are subject to these specifications.
 - 5.3 Made to measure Goods are only accepted on current ordering platforms and must be supported by technical drawings & colour samples where relevant, the seller reserves the right to change the arrangements for placing orders upon notification to the Buyer
 - 5.4 Unauthorised modifications to the Ordering platforms are not permitted.
 - 5.5 Technical drawings and templates need to be clear and unambiguous, with all dimensions and details distinct and legible and must be of a sufficient industry standard to enable a manufacturer to manufacture Goods in accordance with the technical drawing.
 - 5.6 It is the Buyer's sole responsibility to ensure the accuracy of the technical drawings and the Seller shall be entitled to assume that all technical drawings supplied are correct and to manufacture Goods in accordance with such technical drawings. The Buyer shall be responsible for the price of the Goods. If the Buyer discovers an error in the technical drawings once the manufacturing process has commenced, the Buyer should inform the Seller immediately and submit corrected technical drawings and the Seller shall use its reasonable endeavours to correct the error however the Buyer shall remain responsible for any Goods manufactured to the old technical drawings which cannot be stopped and for any charges incurred by the Seller in relation to stopping the manufacture or otherwise.
 - 5.7 The Seller accepts no liability for order and specification details which are not clearly communicated by the Buyer or which are inaccurate, misleading, incomprehensible or incomplete.
 - 5.8 Once an order for Goods is received and the Seller issues an Order Confirmation, the Seller will process it into production subject to receiving any technical drawings or other required specifications (as the case may be). The Seller will not modify the Buyer's measurements in any way and it is the Buyer's responsibility to ensure that the measurements ordered are correct.
 - 5.9 Where the Goods are manufactured to the Buyer's specifications the Seller does not warrant or guarantee the Goods' tolerances or

- 5.10 Due to the nature of e-mail we recommend that the Buyer activates the "read receipt" functionality in the e-mail when placing its order. The Seller shall not be responsible for any failure to deliver e-mails or other electronic communications.
- 5.11 Following processing the Seller will send an Order Confirmation to the Buyer which includes the Seller's order number. The Buyer should contact the Seller if an Order Confirmation is not received within 2 working days of the initial order being placed.
- 5.12 Confirmation of production and shipment only occurs once the order status states the Goods are in production or shows the Goods as being in transit.
- 5.13 Order Status's are uploaded every 24hrs to the buyers area of the Sellers trade portal the Seller reserves the right to amend the frequency on which this is uploaded.
- 5.14 Orders for Goods may require modification or clarification for technical reasons before production can begin. In these cases the Seller will contact the Buyer by e-mail to clarify and confirm the specification beyond doubt, the Buyer will then communicate in writing the specification required.
- 5.15 The Seller reserves the right to discontinue any product or product range without prior notice that the measurements ordered are correct.
- 5.9 Where the Goods are manufactured to the Buyer's specifications the Seller does not warrant or guarantee the Goods' tolerances or fitness for purpose.
- 5.10 Due to the nature of e-mail we recommend that the Buyer activates the "read receipt" functionality in the e-mail when placing its order. The Seller shall not be responsible for any failure to deliver e-mails or other electronic communications.
- 5.11 Following processing the Seller will send an Order Confirmation to the Buyer which includes the Seller's order number. The Buyer should contact the Seller if an Order Confirmation is not received within 2 working days of the initial order being placed.
- 5.12 Confirmation of production and shipment only occurs once the order status states the Goods are in production or shows the Goods as being in transit.
6. Measuring and ordering responsibilities
- 6.1 The Goods are made to the order dimensions and specifications provided by the Buyer.
- 6.2 It is the Buyer's responsibility to satisfy itself that the dimensions and specification it is ordering is correct.
- 6.3 The Seller accepts no liability for the suitability or accuracy of the dimensions and specification relating to the Goods ordered notwithstanding that from time to time the Seller and its staff may provide advice or guidance and/or be in attendance on site at the measuring phase, at the request of the Buyer. Subject to clause 14, where such assistance is provided, it is without liability.
7. Cancellation of the order by the Buyer
- 7.1 Modifications, amendments and cancellations to the order after confirmation can only be made with the Seller's written agreement without which the Buyer accepts full liability for the cost of the Goods under these Conditions.
- 7.2 Since the Goods are made to measure, once production has begun cancellations cannot be accepted and full payment will be required.
- 7.3 The Buyer is advised to secure payment of a non-refundable deposit from their customers prior to placement of the order with the Seller.
8. Documentation and Samples
- 8.1 Subject to clause 14, product specifications, brochures and other literature and any depiction of the Goods in such are supplied for the Buyer's general guidance only and shall not constitute representations by the Seller and the Seller shall not be bound thereby.
- 8.2 Specifications and literature may be changed by the Seller at any time.
- 8.3 Subject to clause 14, samples and published images are provided as indicative examples of the finished product only, finished Goods may vary slightly from the samples and pictures and are not guaranteed to be identical to the finished product.
- 8.4 The Seller is not liable for slight variations in colour or finished appearance.
- 8.5 The Seller cannot guarantee that Goods supplied at different times will match one another. Colours shades may vary by +/- 10%.
- 8.6 The Seller offers a custom colour facility for selected product ranges. Where a custom colour is required the Seller will require a sample of the colour for matching purposes unless the colour is referenced to one of the custom colour palettes listed in the Seller's product specifications in which case it is sufficient to provide the colour reference number.
- 8.7 All colour references not contained within the approved colour palettes in the Seller's product specification need to be matched to a physical sample of the colour provided by the Buyer. Please supply two samples, one for production and one for ordering purposes. The Seller recommends that the Buyer keeps a third sample for its reference. The Seller will match colours to samples as closely as possible but cannot guarantee an identical match.
9. Trade accounts
- 9.1 The Seller reserves the right to refuse to accept orders or to discontinue trading or otherwise withdraw supply without prior notice.
- 9.2 Where an account is inactive for six months the Seller may require new account application details be provided.
- 9.3 Where the Buyer's ownership and account details have changed the Seller must be notified of these changes in writing.
- 9.4 The Seller reserves the right to change the Buyer's discount levels at any time.
- 9.5 Discount levels shall be based on such factors as may be decided by the Seller in its absolute discretion and which may include volume purchase levels and historical payment periods taken by the Buyer to settle invoices and such discounts will be allocated on an order by order basis. Previous discount levels provided by the Seller to the Buyer do not place any obligation upon the Seller to continue to provide the same discounts or to provide any discount at all.
10. Non standard sizes
- 10.1 Certain orders for Goods, including those with special shapes or templates, will be confirmed with a CAD drawing before production. The Seller will forward the CAD drawing to the Buyer by e-mail which must be confirmed in writing by the Buyer that the CAD is an accurate representation of the Buyer's order requirements.
- 10.2 The additional time required for CAD production and approval is an accepted part of the ordering process.
- 10.3 In cases where the installation is fitted to an irregular sized aperture, a template and or technical drawing of the aperture may be required.
- 10.4 Templates and technical drawings should be supplied to the Seller at the same time as the order is placed since the order cannot be progressed without these. It follows that if such documents can be sent electronically delay is significantly reduced. Please note that in some cases a template can be rendered on a technical drawing, so long as sufficient, clear measurements are provided to accurately represent the shape. In such cases the template can be sent electronically.
11. Ex-stock orders
- 11.1 In addition to the supply of Made to Measure orders we may also sell a limited range of Goods from stock. Whilst every effort is made to hold appropriate stock levels of such items, availability is not guaranteed and goods may be withdrawn from sale without prior notice.
12. Deliveries
- 12.1 The Seller will contact the Buyer to arrange delivery of the Goods. All dates and delivery times given are estimates only which are given as a guide and without liability and may be subject to change without prior notice. Time is not of the essence and the Seller accepts no liability where timings vary from the estimates given.
- 12.2 The Seller reserves the right to charge the Buyer a missed delivery charge in addition to any regular delivery charges in cases where, despite a pre-arranged delivery agreement, the Buyer is not present to accept delivery.
- 12.3 Delivery shall take place at the Buyer's main place of trading. Other delivery destinations may be arranged by request but will be subject to special delivery charges which vary according to volume and location as advised and which the Buyer shall be responsible for paying.
- 12.4 The Seller endeavours to deliver all Goods with minimum delay. In the event that the Seller is required by the Buyer to hold Goods for a period greater than seven days, weekly warehouse storage charges will apply per full week the Goods remain with the Seller, which the Buyer shall be responsible for paying.
- 12.5 The Seller is responsible for the delivery of Goods to the Buyer's premises or agreed delivery location. The Buyer is responsible for receiving and checking the Goods and storing them within their premises. Delivery notes must be signed for and mis-deliveries, packaging damage or shortages at the time of receipt should be noted on the delivery note at the time of delivery and notified to the Seller within 72 hours; failure to notify shall be deemed the Buyer's acknowledgement of the correct delivery and acceptance of the Goods.
- 12.6 The Seller reserves the right to hold delivery of Goods until such time the Buyer's credit with the Seller is in line with agreed limits, or such period as the Seller so determines.
- 12.7 Subject to clause 14.4 The Seller does not accept consequential liability for goods which are lost, short delivered or damaged, and for the purposes of this clause consequential liability shall include but not be limited to any loss suffered by the Buyer's customer as a result of incomplete set of shutters being installed or otherwise, and loss of profit, loss of goodwill, loss of opportunity or contract or any other loss as a result of the customer cancelling any order with the Buyer or otherwise.

13. Installation responsibility
- 13.1 Installation of the Goods is carried out by and is the responsibility of the Buyer who must ensure that the Goods are fitted by suitably qualified installers.
- 13.2 Subject to the provisions of clause 14.4 the Seller accepts no responsibility for the quality or suitability of the installation and carries no liability for any damage or injury which may arise during fitting notwithstanding the fact that from time to time the Seller or its staff may provide advice or guidance and/or be in attendance on site at the fitting phase, at the request of the Buyer. Where such assistance is provided it is without liability.
14. Warranty and Liability
- 14.1 Goods conforming to the published specification are covered by the Seller's warranty set out in clause 14.3.
- 14.2 Goods which fall outside of the Seller's standard specification may be manufactured at the Seller's discretion but no part of the Goods will be covered by warranty.
- 14.3 Subject to the following provisions, the Seller warrants that (a) the Goods will correspond with their specification published by the Seller at the time of delivery and the Colour fastness will remain true for a period of 3 years, and (b) the Shutters will be free from defects in workmanship for a period of 3 years from delivery and (c) the Hardware will be free from defects for a period of 1 year from delivery and (d) the Stainless steel Hardware will be free from defects for a period of 3 years from delivery,
- 14.3.1 The above warranty is given by the Seller subject to the following conditions:
- 14.3.1.1 the Seller shall be under no liability in respect of any defect in the Goods arising from any drawing, design or specification supplied by the Buyer;
- 14.3.1.2 the Seller shall be under no liability in respect of any defect arising from fair wear and tear, wilful damage, negligence, abnormal working conditions, failure to follow the Seller's instructions (whether oral or in Writing), misuse or alteration or repair of the Goods without the Seller's approval;
- 14.3.1.3 the Seller shall be under no liability under the above warranty (or any other warranty, condition or guarantee) if the total price for the Goods has not been paid by the due date for payment;
- 14.3.1.4 the above warranty does not extend to parts, materials or equipment not manufactured by the Seller, in respect of which the Buyer shall only be entitled to the benefit of any such warranty or guarantee as is given by the manufacturer to the Seller.
- 14.3.2 Subject as expressly provided in these Conditions, all warranties, conditions or other terms implied by statute or common law are excluded to the fullest extent permitted by law and where the Goods are sold to a person dealing as a consumer (within the meaning of the Unfair Contract Terms Act 1977) the statutory rights of the Buyer (as a consumer) are not affected by these Conditions.
- 14.3.3 A claim by the Buyer which is based on any defect in the quality or condition of the Goods or their failure to correspond with the Seller's published specification shall (whether or not delivery is refused by the Buyer) be notified to the Seller within seven days from the date of delivery or (where the defect or failure was not apparent on reasonable inspection) within a reasonable time after discovery of the defect or failure and the defective Goods shall be returned to the Seller at the Buyer's cost. If delivery is not refused within the above time period, and the Buyer does not notify the Seller accordingly, the Buyer shall not be entitled to reject the Goods and the Seller shall have no liability for such defect or failure, and the Buyer shall be bound to pay the price as if the Goods had been delivered in accordance with the Contract.
- 14.3.4 On receipt of the defective Goods the Seller shall inspect the same and if it verifies the defect the remaining provisions of this clause 14.3 shall apply, however, if the Seller does not verify the defect then it shall reject the warranty claim and shall return the Goods to the Buyer at the Buyer's cost.
- 14.3.5 Where a valid claim in respect of any of the Goods which is based on a defect in the quality or condition of the Goods or their failure to meet the Seller's published specification is notified to the Seller in accordance with these Conditions, the Seller may replace the Goods (or the part in question) free of charge or, at the Seller's sole discretion, refund to the Buyer the price of the Goods (or a proportionate part of the price), in which case the Seller shall have no further liability to the Buyer.
- 14.3.6 Where the Seller replaces the Goods in accordance with clause 14.3.5 then the replacement Goods shall be shipped by sea from the manufacturing plant in China (or such other manufacturing plant) to the UK and then delivered to the Buyer's premises or such other location as may be agreed by the Supplier in writing. If the Buyer wishes the replacement Goods to be shipped by air freight then the Buyer shall be responsible for the additional charges incurred in shipping.
- 14.3.7 The Seller shall not be responsible for any costs associated with the removal of any defective Goods from the end user premises or the installation of any replacement Goods or any remedial visits.
- 14.4 Nothing in these Conditions shall limit or exclude the Seller's liability for: death or personal injury caused by its negligence, or the negligence of its employees, agents or subcontractors (as applicable); or fraud or fraudulent misrepresentation; or breach of the terms implied by section 12 of the Sale of Goods Act 1979 or section 2 of the Supply of Goods and Service Act 1982; or defective products under the Consumer Protection Act 1987; or any matter to the extent to which it would be unlawful to exclude or restrict liability.
- 14.5 Subject to clause 14.4, the Seller shall under no circumstances whatever be liable to the Buyer, whether in contract, tort (including negligence) or restitution, or for breach of statutory duty or misrepresentation, or otherwise, for any the following heads of claim and each one of the following shall be deemed a separate head of claim: (i) loss of profit; (ii) loss of goodwill; (iii) loss of business; (iv) loss of business opportunity; (v) loss of anticipated saving; (vi) loss or corruption of data or information; or (vii) special, indirect or consequential loss; arising under or in connection with the Contract; and
- 14.6 The Seller's total liability in respect of all other loss or damage arising under or in connection with the Contract, whether in contract, tort (including negligence), breach of statutory duty, or otherwise, shall in no circumstances exceed the price of the Goods under the relevant Contract.
- 14.7 If a number of defaults give rise to substantially the same loss or are attributable to the same or similar cause, then they shall be regarded as giving rise to only one claim.
- 14.8 The Seller will be afforded a reasonable opportunity to remedy any such defaults.
- 14.9 This clause 14 shall survive termination of the Contract.
- 14.10 The Seller shall not be liable to the Buyer or be deemed to be in breach of the Contract by reason of any delay in performing, or any failure to perform, any of the Seller's obligations in relation to the Goods, if the delay or failure was due to any cause beyond the Seller's reasonable control including but not limited to:
- 14.10.1 acts of God, explosion, flood, tempest, fire or accident;
- 14.10.2 war or threat of war, sabotage, insurrection, civil disturbance or requisition;
- 14.10.3 acts, restrictions, regulations, bye-laws, prohibitions or measures of any kind on the part of any governmental, parliamentary or local authority;
- 14.10.4 import or export regulations or embargoes;
- 14.10.5 strikes, lock-outs or other industrial actions or trade disputes (whether involving employees of the Seller or of a third party);
- 14.10.6 difficulties in obtaining raw materials, labour, fuel, parts or machinery; and
- 14.10.7 power failure or breakdown in machinery.
15. Return of Goods
- 15.1 The return of Goods for credit will not be accepted without prior notification to the Seller and written acceptance by the Seller and shall be substantiated with photographic evidence prior to return.
- 15.2 Goods to be returned must be suitably packaged to prevent loss or damage in transit.
16. General
- 16.1 This agreement, and any documents referred to in it, constitute the whole agreement between the parties and supersede any previous arrangement, understanding or agreement between them relating to the subject matter they cover.
- 16.2 If any provision of this agreement (or part of a provision) is found by any court or administrative body of competent jurisdiction to be invalid, unenforceable or illegal, the other provisions shall remain in force.
- 16.3 If any invalid, unenforceable or illegal provision would be valid, enforceable or legal if some part of it were deleted, the provision shall apply with whatever modification is necessary to give effect to the commercial intention of the parties.
17. Jurisdiction
- 17.1 These terms and conditions are governed by the laws of England and the parties shall submit to the Jurisdiction of the English courts.



Newdown Farm
Micheldever
Winchester
Hampshire
SO21 3BT
01962 794530
www.s-craft.co.uk
ShutterCraft Ltd.
(Trading as S:CRAFT)