

## 6760-1080P WIFI Bluetooth Radio Clock: Yoosee Android/iPhone Application

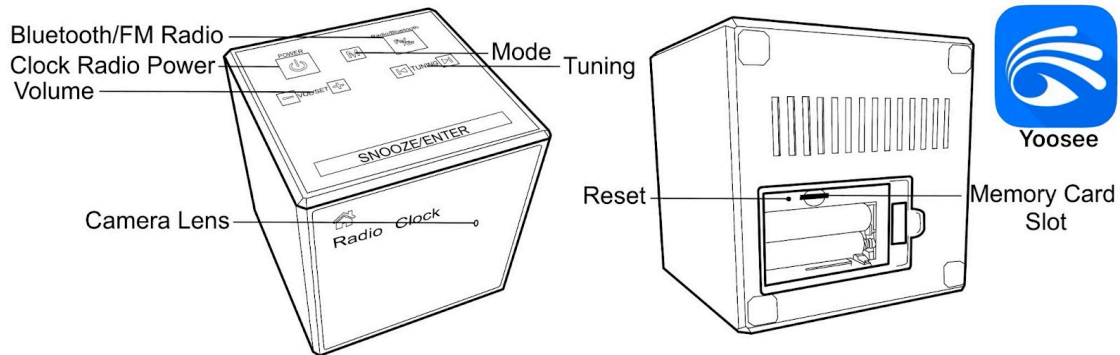

### To start:

- Insert an SD card into the memory card slot on the bottom side of the device under the battery cover
- Plug in the power cable to power on the device
- While you wait for the device to boot up, download the "Yoosee" application from the Apple or Google Play Store
- Open the "Yoosee" application
- Make sure to allow all pop up's for the application; otherwise, results may vary

### Radio clock operations:

- Taping the power button turns the radio on/off
- Hold "M" mode to auto-search and save radio channels (Up to 20 can be stored)
- Tap the "M" to switch between them
- Tap the tuning button to adjust the frequency
- Switching between radio and Bluetooth, tap the FM/BT button
- On the front of the device will be BT
- Bluetooth: KT-V100
- When connected to Bluetooth, the "M" button will pause/stop while the tuning will play the next track or go back
- Set up the clock by first turning the radio off
- Holding the M button changes 24/12 hour, set time, set alarm. Use the Vol/Set to navigate, and tap the M to move to the next setting
- If an alarm clock is visible on the front, then the alarm is active. To disable hold the snooze button

**Connecting to WIFI:**

- Open the camera application and go through these steps before connecting to the camera's WIFI
- Open the "Yoosee" App, and tap the (+) button in the top right corner
- If no QR code is available, tap the "No QR code? Add manually" at the bottom of the screen
- Select "WIFI Camera's"
- Select next once the above operations finished is checked
- Select "Add by WIFI"
- The App will then go into your phone's WIFI so that you can select the camera's WIFI example: GW\_AP\_xxxx
- Your phone may ask you to pick between cellular or WIFI. Select the WIFI option, and once connected, return to the Yoosee application
- On the Wi-Fi Settings menu, select the downward arrow next to "Please Select Wi-Fi for connection"
- Select the locations WIFI and enter the WIFI password
- Once completed, the camera will connect and be online
- Before finishing, test your connection by entering your phone settings, turning off WIFI, and re-opening the Yoosee App. It is connected if the device is online and can get a live view.
- If not, check your WIFI password, reset the camera, and retry these steps.

**Note: This device will not connect with a 5G network.**

**Note: If the setup process has been completed, and you cannot connect to the camera, hold the "Reset" button next to the SD card slot for about 10 seconds and then repeat the process above after the camera has rebooted.**

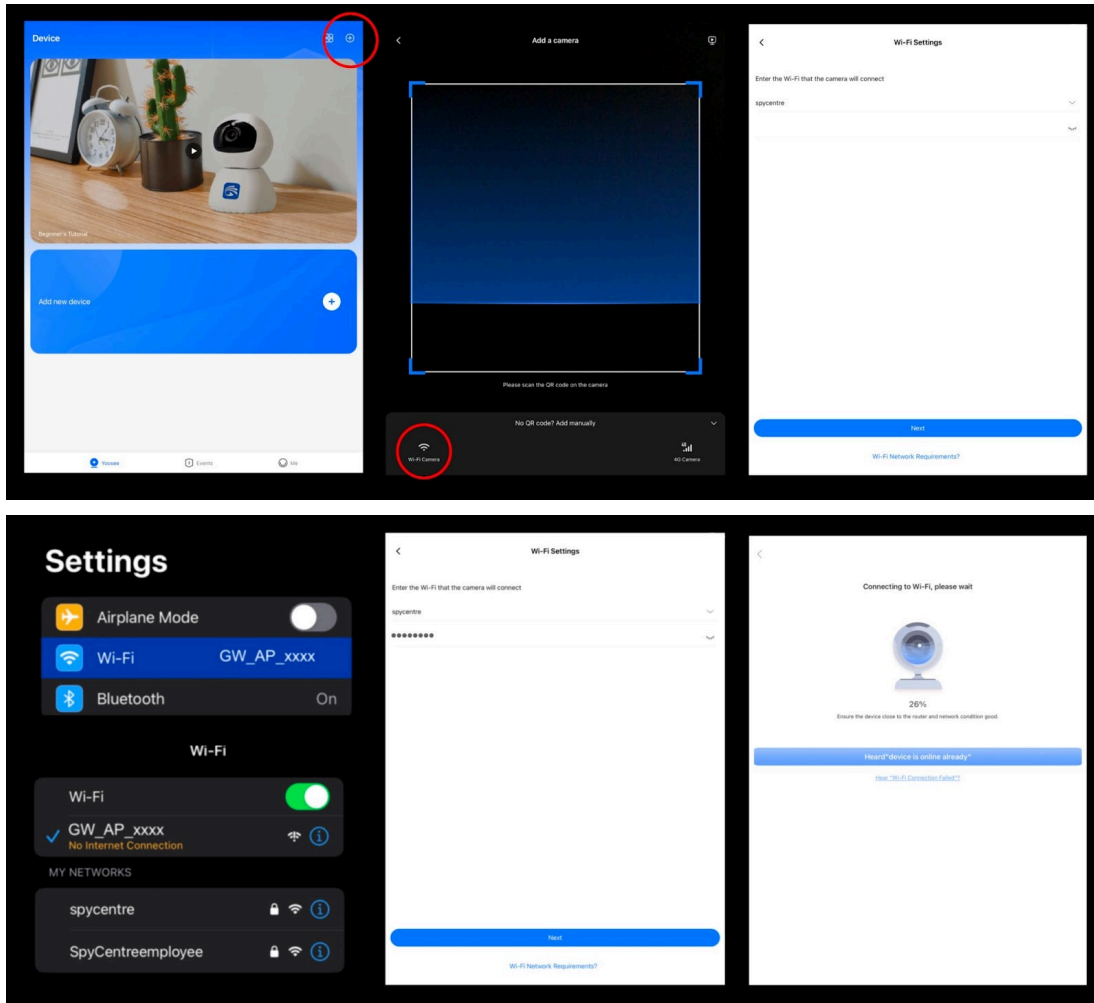

### Standalone mode (No Internet):

- For using the camera without an internet connection, follow these steps
- After downloading the app, go into your phone's WIFI so that you can select the camera's WIFI example: GW\_AP\_xxxx
- Your phone may ask you to pick between Cellular or WIFI. Select the WIFI option, and once connected, return to the Yoosee application.
- On the the top of the screen is "Standalone mode" The camera is connected in P2P and is not connected to the internet
- The camera will be able to record and review but will not be remotely accessible.
- To connect the camera to the internet, follow the "Connecting to the internet" section

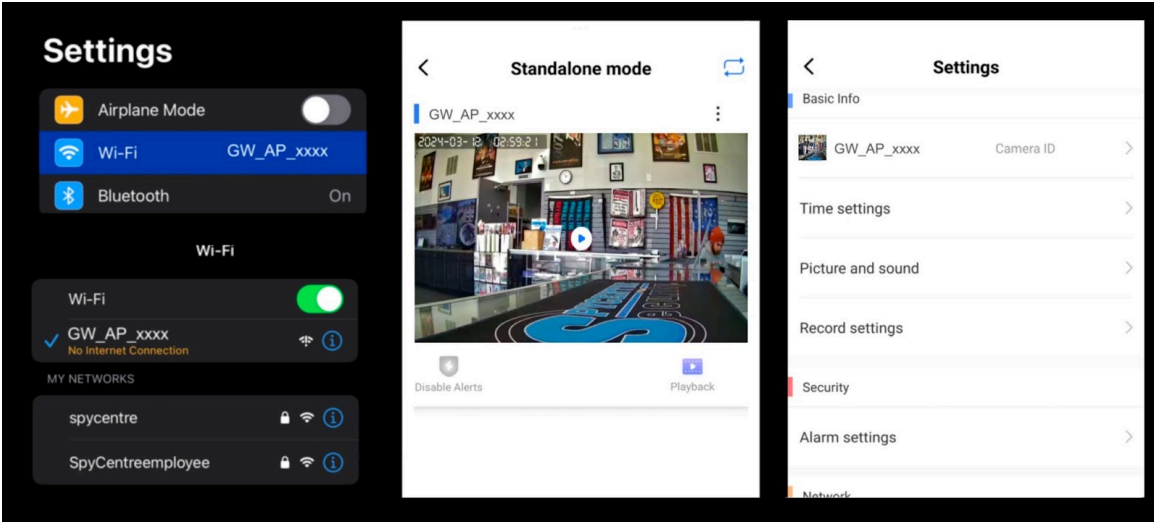

### Device main menu explained:

- When a camera is online, it will be present on the device list
  - **3 Dots:** Device settings/sharing screen
  - **Alerts:** When active the device will take a picture and save it to the events when motion is seen.
    - When “On Guard” is present, the alerts are enabled
  - **Playback:** Access and replay information recorded to the Memory card
  - On the bottom of the screen is
    - **Yoosee:** Device list main screen
    - **Events:** When alerts are active and on guard, a picture is saved here
    - **Me:** General account settings

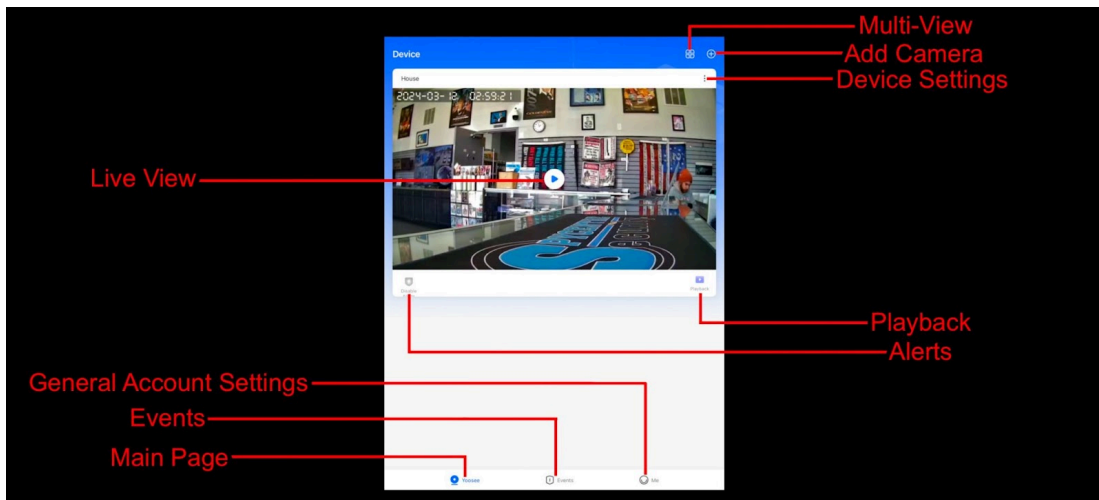

### Device settings menu:

- To the right of the camera on the device's main menu is an icon that looks like three dots. Click the icon and select Settings
- When finished with a setting, click the "<" back button in the top left corner to go back to the camera list

- **How to set up the camera:**
- Basic Info
  - **Time Zone:** Adjust the time for the camera and recordings
  - **Picture and Sound:** Adjust the volume and picture quality, set the camera to NTSC format
  - **Record Settings:** Change between all day, alarm (Motion), or schedule Recording. If the TF card capacity is not present and a memory card is inserted, Format the TF card
- Alarm
  - **Scheduled alert:** If set, the camera will only notify during this time
  - **Alarm type:** Turning on motion detection and motion sensitivity
  - **Alarm mode:** adjust and customize notification setting
- Network
  - **Network settings:** Current connected network, switch networks
  - **NVR connection:** ONVIF settings and password change for NVR config
  - **Firmware upgrade:** Current firmware check
  - **Question feedback:** Yoosee support ticket

#### How to set motion activation:

- Click on “Alarm type”
- Turn on “Motion Activation”
- Click on “Record Settings”
- Change from “All day record” to “Alarm record”

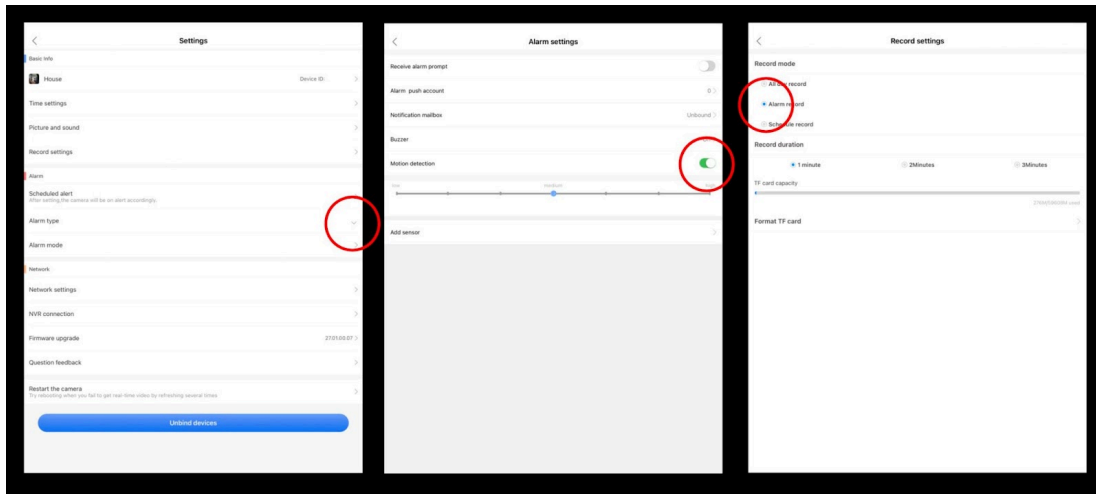

## How to review recordings:

- Tap on the playback button located under the camera on the device list
- The most current recording will begin playing
- To move between recordings and dates, swipe on the timeline or select the calendar to select a different date
- To take a picture of the playback, tap the scissors icon
- To save or download the playback, first replay the section you are needing
- While playing, tap the video recorder icon, and a red dot will be present
- Once finished, tap the video recorder icon again
- The video clips and pictures are saved to the album located in the me (general information) at the bottom of the screen
- To download the video clips or picture, the individual file must first be opened, and a share icon will be accessible at the bottom of the screen

**Note: To review files on a computer, pull the SD card, plug it into a Windows or Mac computer, and use VLC Media Player for playback.**

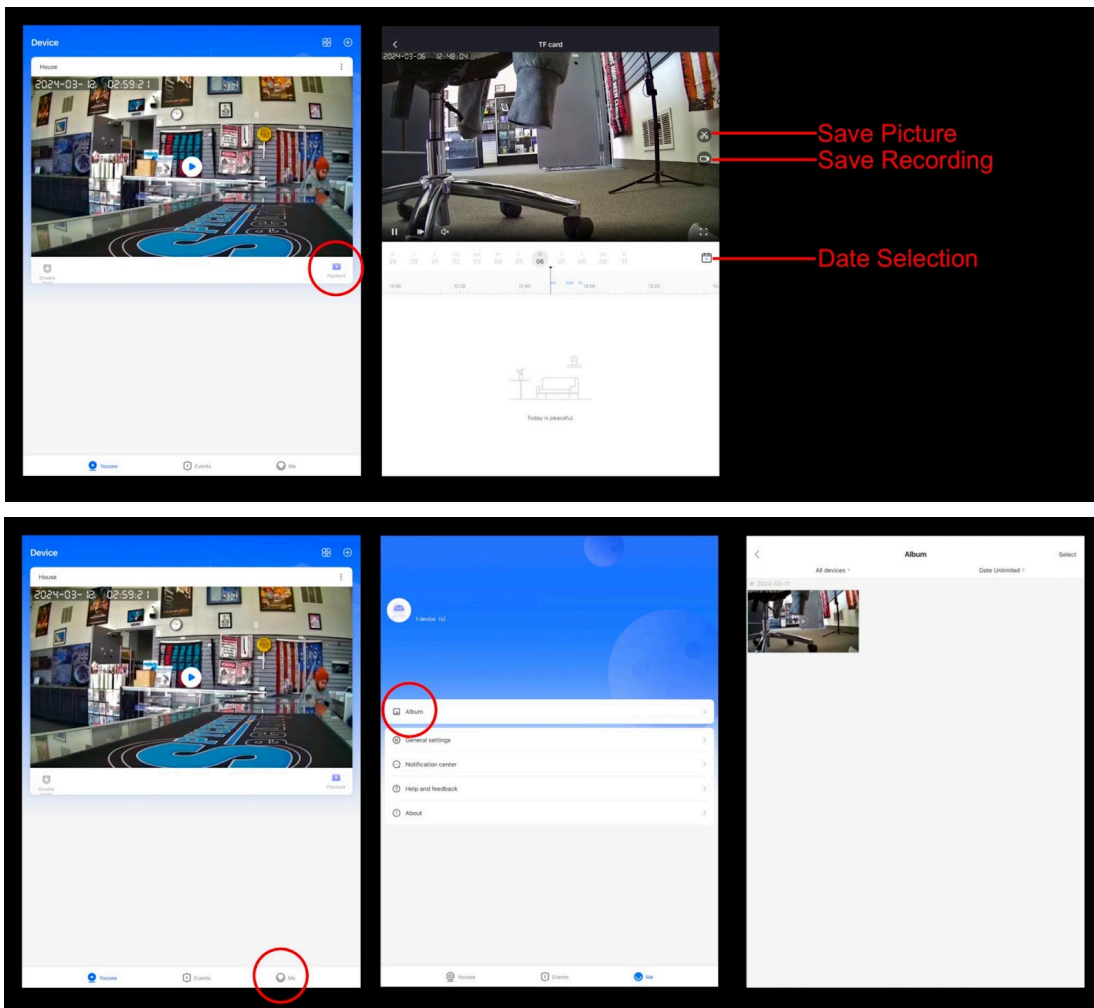

### How to live stream:

- Tap the camera to start the live stream on the main device page. The camera may require a moment to connect, especially if your phone is connected to a cellular service.
- When viewing the live stream, tap the live stream to change the stream resolution (FHD, HD, and SD) as well as the option to be full-screen
- The scissors icon at the bottom left will take a snapshot of the live stream and save it to the application using the phone's memory
- If your model camera has PTZ, the PTZ control will move the camera
- The microphone button allows for speech
- The sound button allows for live audio
- The three lines icons are for accessing playback, Alarm notifications, and multiscreen sharing (multiscreen sharing is only useable using a multiscreen sharing app)
- The gear icon in the top right is for accessing the device settings menu

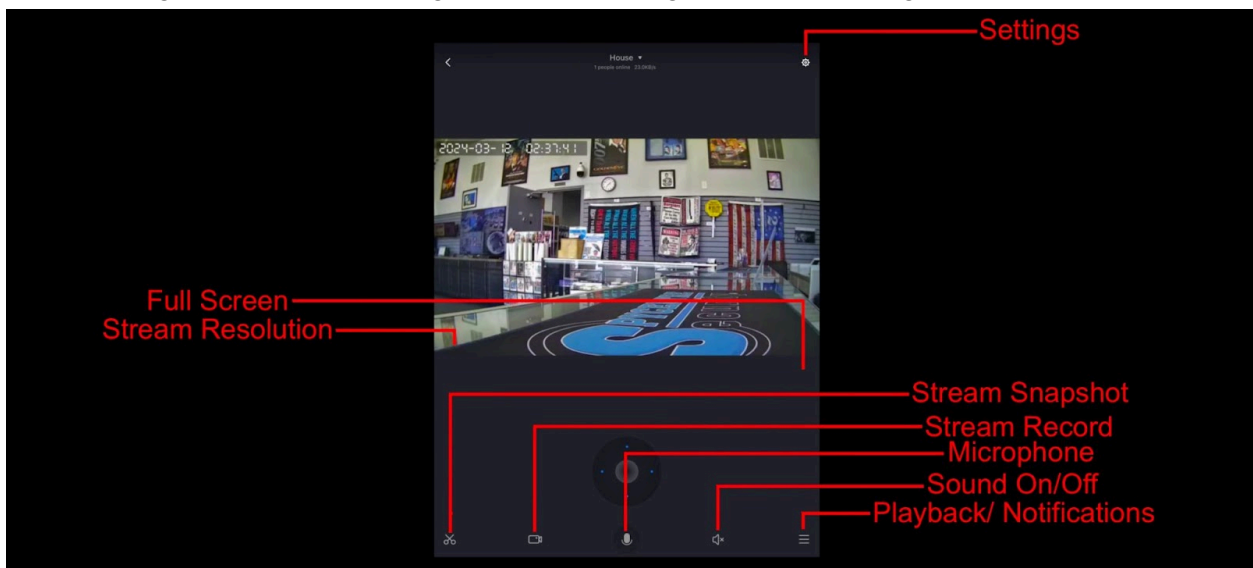

**NOTE:** In order to playback recordings on a computer, the file must first be saved using the Application. Inserting the SD card directly into a computer will not allow for files to be opened.

### How to play files on a Windows computer:

- First, open the Yoosee application and tap the “Me” button on the bottom right
- Open the Album and tap on the file you wish to move to the computer
- Tap the “Share” icon and then select save to files
- Now the video file will download and convert from a .AV format to a .MP4 and save on your phones file folder
- Connect the phone to a computer using the charging cable to access the stored footage on the phone



### How to playback files on a Mac computer:

- First, open the Yoosee application and tap the “Me” button on the bottom right
- Open the Album and tap on the file you wish to move to the computer
- Tap the “Share” icon and then select save to files
- Now the video file will download and convert from a .AV format to a .MP4 and save on your phones file folder
- Connect the phone to a computer using the charging cable to access the stored footage on the phone



### How to playback files on a Google Chromebook:

- First, open the Yoosee application and tap the “Me” button on the bottom right
- Open the Album and tap on the file you wish to move to the computer
- Tap the “Share” icon and then select save to files
- Now the video file will download and convert from a .AV format to a .MP4 and save on your phones file folder
- Connect the phone to a computer using the charging cable to access the stored footage on the phone
- A pop-up menu may occur; if so, select “View Files”
- If a pop-up does not occur, select the “O” icon called the “App Launcher” similar to a Windows icon button located in the bottom left corner of the screen
- Underneath the “Google Drive” are “My Drive,” “Downloads,” “New Services,” and something else that may be named “Removable Drive”
- Select the “Removable Drive.” If unsure of this step. Disconnect the device from the Chromebook and see what is no longer available under Google Drive from step 4
- After selecting the “Removable Drive,” you can now navigate the folders in the main folder to find the recorded files
- Double-click to play



### How to download VLC Media Player on a Mac computer

- Go to [www.videolan.org](http://www.videolan.org) and click the “Download VLC”
- It will open a new window and begin downloading
- If it does not automatically start downloading, press the “Click Here” and select one of the mirrored sites
- Once completed, a new file named VLC will be visible on the desktop
- Open the folder, and in the folder, move the VLC to the “Applications Folder” by dragging and dropping it
- Once in the “Application Folder,” the VLC player will complete the installation
- Open VLC Media Player in the “Applications Folder” and drag your video files to the “Drag Here” dialog box to open and play
- If the VLC player is not installed, a change to the security and privacy settings is needed
- To access your security and privacy, click on the Apple icon on the taskbar and select “System Preferences”



- Select “Security and Privacy”
- Make sure the lock icon on the bottom of the screen is open and set to “Make Changes”
- Select the button “Open Anyway”
- VLC will now be fully installed

### How to download and use VLC Media Player on a Windows computer

- Go to [www.videolan.org](http://www.videolan.org) and click the “Download VLC”
- It will open a new window and begin downloading
- If it does not automatically begin downloading, press the “Click Here” and select one of the mirrored sites
- Once downloading has been completed, select run and install
- Once finished, a VLC icon will now be available on your PC
- To default, open a file in VLC Media Player, right-click on the file you wish to open and select “Open With,” and choose VLC
- To change all files to default, open with VLC Media Player: Right-click and choose “Properties,” then click on the “Change” button next to “Open With” and change it to VLC, then press ok. Now the files will default open with VLC

**Note: If the memory folder of the recorder does not automatically open when connected to a PC, disconnect the device and perform the following.**

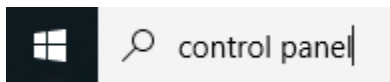

1. Type “Control Panel” in the search bar and select “Programs”
2. Under “Default Programs,” click “Change Default Settings for Media or Devices”
3. Under “Removable Devices,” select “Open Folder” to view files
4. Save and reconnect the device to the computer

The Spy Gear Superstore® Since 1993