

RE-INVENTED RECLINER™ COLLECTION

ELTON



**AMERICAN
LEATHER**

Standard Features:

- Advanced unidirectional suspension system
- Down blend pillow top pad on back
- Premium high-density, high-resiliency foam seat encased in down
- Semi-attached back cushion
- Tight seat cushion
- Channel detail on back and seat cushion
- Single-needle top-stitch
- Lifetime warranty on frame and suspension
- Quick-ship delivery
- Wood arms in Dark Brown finish

Options:

- Premium high-density, high-resiliency foam pillow top pad on back
- Premium high-density, high-resiliency foam seat

Additional Power Options:

- Motorized recliner with an on-seat control panel that is easy to use and includes a USB charging port
- Motor has a five-year warranty
- Lithium-ion battery pack available
- Battery pack has a one-year warranty

Please use actual leather, fabric, Crypton®, Sunbrella® and Ultrasuede® swatches when specifying furniture as the colors shown may vary due to the printing process.

Wall Clearance is 16"

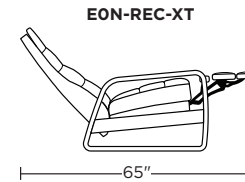
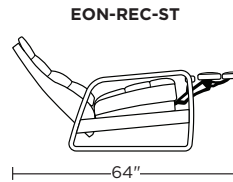
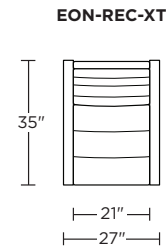
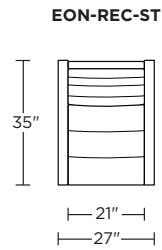
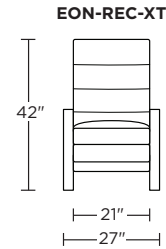
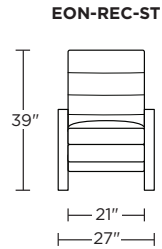
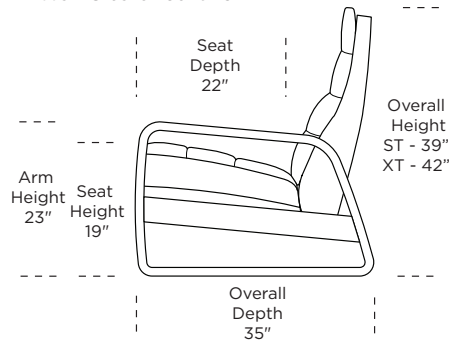

Scale: 1/4 inch = 1 foot
All dimensions are approximate and subject to change.
Specify components from the sitting position.