



USER MANUAL
COMMANDER 2000 ACDC PULSE MIG/TIG





Please read carefully this user manual before using this machine

Keep it for the future use.

MANU

SAFETY	1
APPLICATION	4
DESCRIPTION OF THE MACHINE	4
TECHNICAL DATA OF THE DEVICE	5
DEVICE CONNECTION - WELDING POLARITY SETTING	10
PANEL OPERATION-GENERAL	11
-MIG OPERATION	12
-TIG ACDC OPERATION	21
-MMA OPERATION	34
ERROR CODE	36
ELETRICITY SAFETY GUIDLINES	37

1. Safety

It is imperative that you read the following signs and safety rules to protect your own and other people's health and life.

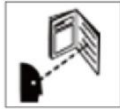

Read the instructions before starting the device. Use only original equipment supplied by the manufacturer.



Some components may explode. Always use a face shield and protective clothing with long sleeves.



Static voltage can damage electronic components.



Use approved face shields and welding shields. Always use protective clothing designed for welders. Metal splinters can damage your eyes. Always use safety glass.



Electric shock can result in death. Do not touch electrical components when the device is connected to power. Use dry and complete protective gloves and protective clothing.



Gases and vapors can be hazardous to health. Welding gases and fumes are emitted during the welding process. Inhalation of these substances can be hazardous to health.

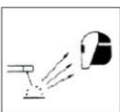

Eye protection with welding filters. Depending on the current used, use protective shields with appropriate filters.



Moving parts of the device can cause injuries.

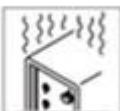

Continuous operation for too long can cause device to overheat. Wait until the device cools down.



Damaged technical gas cylinders may explode. The cylinders contain high pressure gas. Make sure that cylinders are handled and stored in accordance with health and safety and

fire protection requirements.



Welded parts may burn.



The protruding wire from the torch is sharp and can cause skin puncture.



Danger of fire and explosion. During welding work, a fire may result. The welding station must be remote and protected against flammable and explosive materials.



The magnetic field can disrupt the functioning of pacemakers. Consult a doctor before starting work.



Do not weld at height without proper protection.



A device falling or falling over may cause injury.

- Before starting work, specify the place where the device is to be operated.
- The device should be connected to the network so that it can be freely manipulated at all times.
- The power cord should not be taut during operation.

- Do not use the device on a surface that may cause it to tip over.

- To move the device, use only the handle on the front of the device. Do not pull on the welding or power cord.

- Moving and transporting the device and cylinders with technical gases should be carried out separately. Only carry the machine using the factory carrying handles.

- Incorrect use is prohibited.

ATTENTION!

The heating test was carried out at ambient temperature and the duty cycle (load factor) at 25°C was determined as a result of the simulation.

The device is intended for conducting professional welding works in industrial conditions by personnel having valid qualification certificates in accordance with applicable standards.



WARNING: This Class A equipment is not intended for use in residential areas where electricity is supplied through the public low voltage network system. There may be potential difficulties in ensuring electromagnetic compatibility at these locations due to conducted and radiated disturbances.

The device should be operated in accordance with the Regulation of the Minister of Economy of April 27, 2000. on health and safety at work during welding (Journal of Laws No. 40 item 470)

Keeping this user manual and following the guidelines outlined in it will allow for proper maintenance of the device in the future. The following warnings are intended to ensure user safety and environmentally friendly operation. Read the entire manual carefully before installing and using the device.

- After opening the packaging, check that the device has not been damaged during transport. If in doubt, contact our service department.
- The device should only be used by a trained employee or consumer.
- When installing the appliance, you should entrust all electrical activities to a qualified electrician.

2. APPLICATION

This devices are used for manual arc welding in the GMAW (Gas Metal Arc Welding), GTAW (Gas Tungsten Arc Welding) and SMAW (Shielded Metal Arc Welding) methods.

3. DESCRIPTION OF THE MACHINE

devices are modern inverter sources offering very high welding versatility. Their main advantage is the possibility of welding using single or double pulse current in MIG or MAG mode. Thanks to the use of modern IGBT technology and high-quality components, they are ideal for works related to the automotive industry, steel constructions, welding of aluminum alloys and others.

Reliability, a wide range of applications (the ability to carry out work in three welding methods: MIG / MAG, TIG- AC DC, MMA make the device satisfy even the most demanding users.

4. TECHNICAL DATA OF THE DEVICE

Characters		COMMANDER 2000
Rated input voltage[V]		240V
Frequency[Hz]		50/60
Output current range[A]	MMA	30-200
	TIG	10-200
	MIG/MAG	40-200
Output voltage	MMA	21.2-28
	TIG	10.4-18
	MIG/MAG	16-24
Duty cycle[%] (at ambient temperature 40°C)		20% 200 [A] 60% 160A 100% 120A
Rated input power [kVA]		13.9
Power factor		0.93
Work piece thickness[mm]		0.5-5
Feeder type		4R
Welding wire diameter[mm]		0.8/0.9/1.0/1.2
Insulation class		F
Protection class		IP21
Net weight [kg]		28.2
Dimensions [mm]		270X600X540

5. DEVICE CONNECTION - WELDING POLARITY SETTING

MIG/MAG WELDING

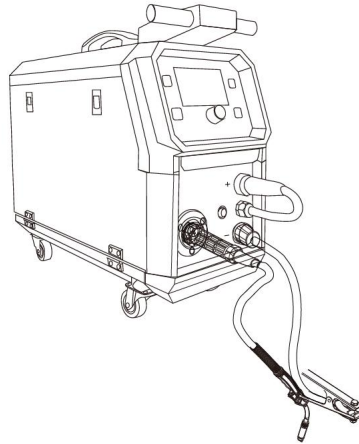

Select the correct welding polarity as shown above.

Positive polarity welding (MIG / MAG gas shielded solid wire welding)

Welder's current plug connected to the positive + socket (EURO)

Earth handle connected to the negative socket -

Welding with Push and Pull torch

Select the correct welding polarity as shown above.

Positive polarity welding (MIG / MAG gas shielded solid wire welding)

Welder's current plug connected to the positive + socket (EURO)

Signal cable connect with 12 pin plug

Earth handle connected to the negative socket -

Welding with negative polarity - (welding with flux cored wire - FCAW)

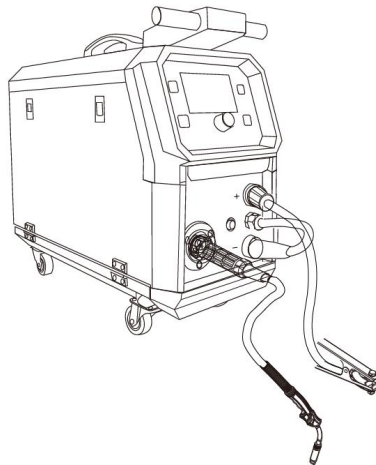

Welder's current plug connected to the negative socket - (EURO)

Earth clamp connected to the positive socket +

WARNING!

To start working with self-shielding wire, change the polarity inside the device - on the wire feeder.

BEFORE YOU WORK:

- Check the voltage, number of phases and frequency of the power supply before connecting the device to the mains.
- Power supply voltage parameters are given in the chapter with technical data and on the rating plate of the device.
- Check the connection of the grounding wires of the device to the mains.
- Ensure that the power supply network can provide coverage of the input power demand for this device under normal operating conditions. The fuse size, the parameters of the power cord are given in the technical data and on the rating plate. Connection and replacement of the power cord and plug should be made by a qualified electrician.
- Remove all flammable materials from the welding area.
- Use appropriate protective clothing for welding: gloves, apron, work boots, mask or visor with appropriate certificates.

DEVICE CONNECTION FOR THE MIG / MAG METHOD

- To extend the service life and ensure reliable operation of the device, observe the following rules:
- The device should be placed in a well-ventilated room with free air circulation.

■

■

Do not place the device on wet ground.

Use an electrode wire with diameter and spool weight in accordance with the manufacturer's instructions (D200, max. 15 kg). Check the technical condition of the device and welding cables on an ongoing basis.

Welding wire spool assembly:

This device is equipped with professional wire feeder, it has 4 rolls feeder enabling work with 2 handles max 4mb when welding with steel wire and with 3mb when welding with aluminum alloy wire, The welding wire holder allows the installation of reels with a diameter of 300mm-15kg.

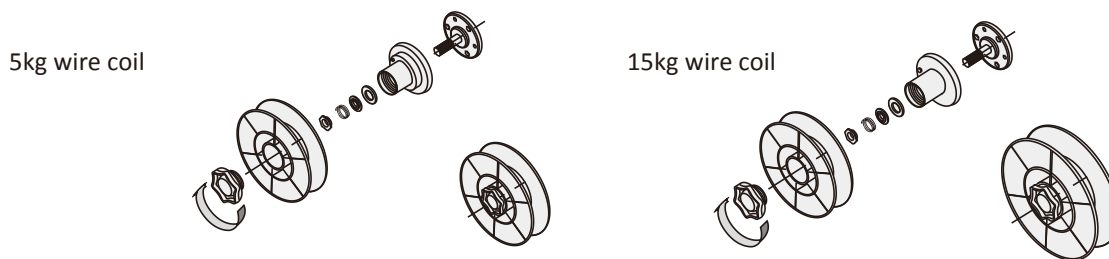

- Lift the side cover of the semi-automatic housing.
- Ensure that the rollers fitted in the drive unit match the type and diameter of wire used. Rolls should be used for steel wires with "V" shaped grooves, while for aluminum wires with "U" type grooves.
- Apply welding wire spools to the spool clamping mechanism, paying attention that the unwinding direction of the wire is consistent with the direction of the wire's entry into the drive unit. Lock the spools before slipping by tightening the nut on the spool mounting body.
- The end of the wire should be straightened or cut off a bent section.
- To feed wire into the feeder, release the pressure of the feed rollers.
- Insert the end of the wire into the guide located at the back of the feeder and route it over the drive roller by inserting it into the welding gun stub.
- Tighten the wire in the drive roller groove and tighten.
- Remove the gas nozzle from the burner and unscrew the contact tip.
- Turn the device on.
- Unwind the welding gun cable so that it is straight. ATTENTION! Do not drive the welding torch ends towards the face or other people.
- Press the welding button on the welding gun and hold it until the wire appears behind the torch.
- When the end of the welding wire passes through the connector in the torch, release the button approx. 5 cm and replace the contact tip and gas nozzle.

- Adjust the clamping force by turning the knob, clockwise-increases the clamping force, to the left-decreases the clamping force. Too low clamping force will cause the drive roller to slip. Too much pressure increases the feed resistance and deforms the wire.

We recommend placing the wire into the welding gun with the valve on the shielding gas cylinder closed. This will reduce its unnecessary losses.

Installation of shielding gas cylinders:

- A cylinder with a suitable shielding gas must always be properly secured against falling over. If possible, attach to an approved welding carriage with the MIG / MAG device. The trolley is not standard equipment of the set.
-
- Connect the semi-automatic machine to the cylinder with a suitable hose. Unscrew the regulator valve before starting to weld. **Always close the cylinder valve after welding.**

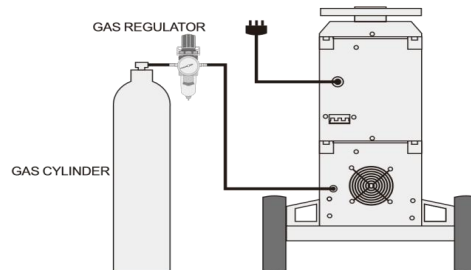

MIG/MAG welding process

Arc welding in gas shields (marked MIG / MAG) is one of the most commonly used processes in the production of welded structures. The abbreviation MAG (Metal Active Gas) includes in its description types of active protective gases. The abbreviation MIG (Metal Inert Gas) refers to inert gas shields. The semi-automatic welding process involves fusing the edges of the work piece and the consumable electrode material with the heat of an electric arc glowing between the electrode in the form of a solid wire and the welded part, in an inert or active gas shield.

The main protective gases used for MIG welding are inert gases such as argon, helium and MAG active gases: CO₂, H₂, O₂, N₂ and NO, used separately or as additives to argon or helium.

The fusible electrode is in the form of a solid wire, usually 0.6 1.2 mm in diameter, and is fed in mm, and is fed in m / min upwards. Welding torches can be cooled by liquid or shielding gas. Welding is carried out mainly with direct current with positive polarity, as semiautomatic, mechanized welding, direct current with positive polarity, as semi-automatic, mechanized, automatic or robotic welding using specialized equipment. The shield of the welding arc glowing between the consumable electrode and the material being welded ensures the formation of the weld under very favorable thermal and chemical conditions. This type of welding can be used to make high-quality joints of all metals that can be joined by arc welding. These include: carbon and low alloy steels as well as corrosion resistant steels. Welding can be carried out in workshop and field conditions in all positions.

SINGLE PULSE MODE

MIG PULSE is an advanced form of welding that uses the best of the forms of the transfer of molten electrode material to the work piece. Unlike short circuits, pulse welding does not produce spatter and there is a risk of cold "leakage". Welding positions in the pulse are not limited because they are derived from globular or spray forms, and their use is definitely more efficient. By cooling the spray arc process, pulsed MIG is able to extend the welding range, and smaller heat input does not cause a problem with burning thin materials. MIG PULSE is one of the best welding processes for a wide range of applications and types of metal.

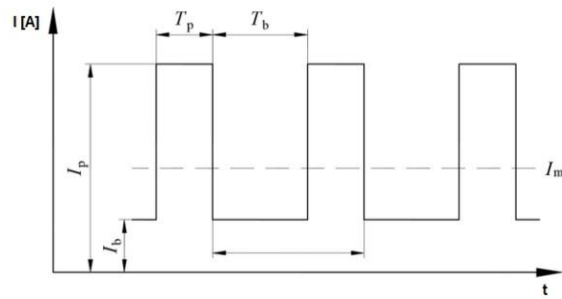

DOUBLE PULSE MODE

Welding with the MIG / MAG method with double pulse we get a high level of face appearance (husk effect). In addition, the use of automatic wire feed affects welding performance. The MIG / MAG method with double pulse allows the regulation of current pulsation (pulse balance) and adjustment of the wire feed speed. Thanks to this, we improve the appearance of the weld. When MIG / MAG welding with double pulse, current pulses occur in two ranges. The sequential system of our devices automatically combines two levels of pulses.

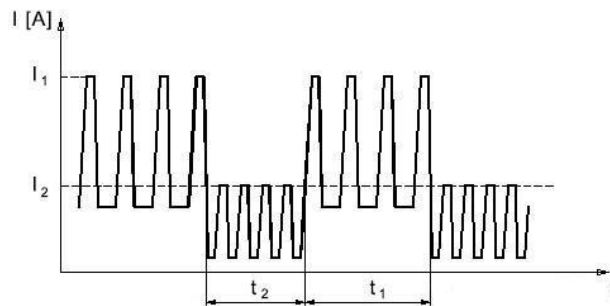

The benefits of using the MIG MAG method with double pulse are:

1. MIG / MAG double pulse welding is faster than TIG welding.
2. MIG / MAG double pulse welding achieves high aesthetics like the TIG method.
3. MIG / MAG double pulse welding results in less deformation than TIG.

A. DESCRIPTION OF THE CONTROL PANEL

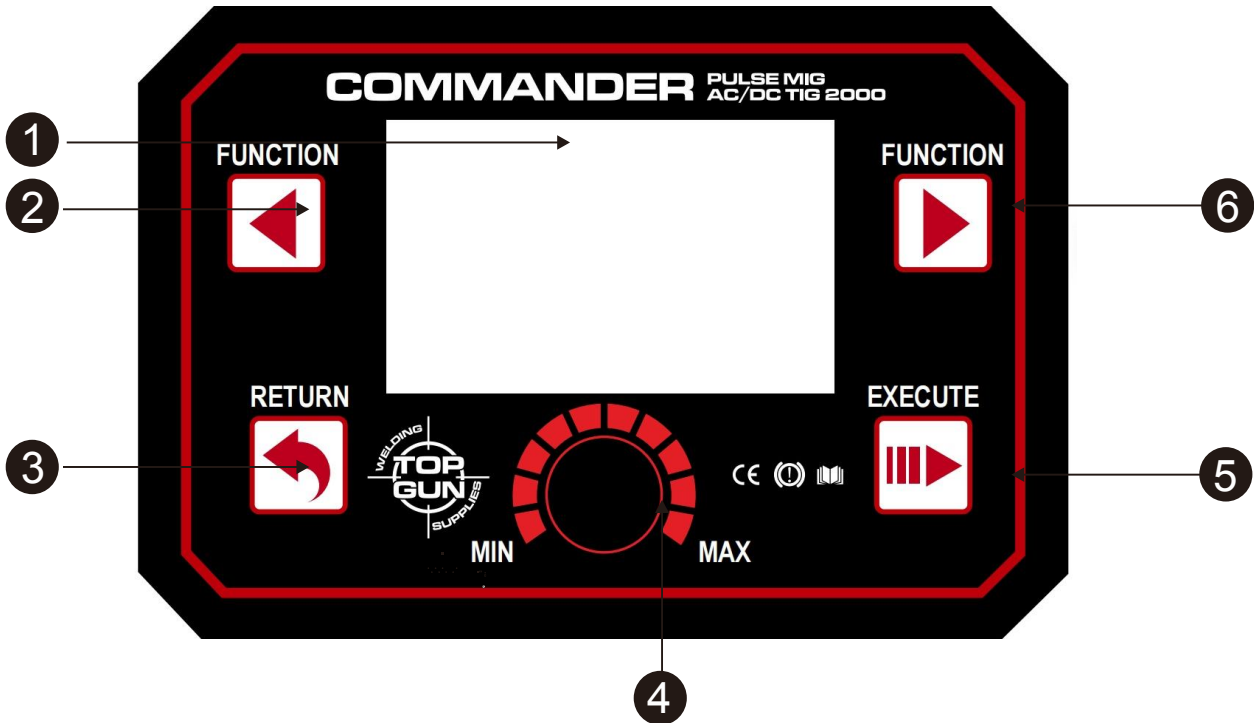

1. LCD display
2. Function selection button, to select the previous menu, holding for 5 seconds to save the current setting in memory.
3. Button to return to the previous menu. (additionally held for 5 seconds to return to the factory settings (RESET)).
4. Adjustment knob,
Turn - Select and Adjust.
Press - Confirm and Switch to next.
5. Button for Confirmation or Enter.
6. Function selection button, to select the next menu, holding for 5 seconds to recall memories;
The device has 18 memory programs.

B. CHOICE OF WELDING METHOD



This page allows you to select welding methods as below:
Synergy, MIG, LIFT-TIG, MMA

Turn the red knob of the front panel to select the welding mode then press for confirmation.

SYNERGY - synergic settings. The user selects the basic welding parameters such as the type of material, thickness of the material to be welded, diameter of the welding wire. Other parameters of the device are selected automatically using the database of uploaded programs.

MIG MODE - welding using individual user settings. The system suggests the selection of key welding parameters, indicating the thickness of the welded material when adjusting them. This information suggests to the user that the settings are correct.

TIG ACDC - TIG mode (ignition of high frequency) - welding with a tungsten electrode in an inert gas shield. It comes with a TIG remote torch in the accessories. On AC mode you can weld aluminum.

MMA MODE - welding with coated electrode. In addition to welding current adjustment, the user can additionally set ARC-FORCE, HOT START and enable or disable the VRD protection system.

ARC FORCE - Stabilizes the arc regardless of fluctuations in its length, reduces the amount of spatter.

HOT-START - a function that makes welding easier. When the arc strikes, the welding current is temporarily increased to heat up the material and electrode at the point of contact, and to properly shape the penetration and weld face at the initial stage of welding.

VRD - the device has a VRD (Voltage Reduction Device) system, which for welding mode MMA with electrodes reduces the open circuit voltage, which significantly increases the user's safety. In special cases of using electrodes with high arc ignition current, problems with its initiation may occur.

D. Synergy function (MIG/MAG)





In the SYNERGY mode, the user only selects the basic welding parameters such as the type of material, the thickness of the material to be welded, and the diameter of the welding wire (0.8mm, 1.0mm 09mm and 1.2mm available). Other parameters of the device are selected automatically using the database of uploaded programs.

The SYNERGY mode only allows continuous welding, it has no possibility to adjust the PULSE and dual PULSE settings.

You can manually correct the synergic settings.

NOTE: If the material type and thickness settings are changed, the system will return with the remaining parameters to the factory default values.

 The screenshot shows the "SYNERGY SETTING" screen. On the left, it displays "Current" at 120 A and "Voltage" at 20 V. In the center, there is a circular menu for "Material selection" with options: Carbon steel, Stainless steel, Al-Mg, Al-Si (highlighted), and Cu-Si. On the right, there is a "Parameter list" showing "φ 1.0 wire", "φ 1.2 wire", and "Thickness φ 0.8 wire". At the bottom, there are buttons for "Operation mode" (2T), "Pulse mode" (ON), "Feeding speed" (17 m/min), and "Wire diameter" (φ 1.2 mm).	<p>Step 1-Choice of material</p> <p>The user selects the welded material (and welding wire) from the list of alloys available in the program.</p>
---	--

	<p>Step 2-Selecting the thickness of the work piece</p> <p>The user chooses the thickness of the welded material. The device automatically selects the intensity on this basis welding current, arc voltage and feeder speed.</p>
---	--

	<p>Step 3 Selecting the welding wire diameter</p> <p>You choose the welding wire diameter you plan to use.</p> <p>ATTENTION! The device automatically reduces or increases its maximum power depending on the wire diameter.</p>
---	--

	<p>Step 4 Selecting the welding wire diameter</p> <p>You choose the welding wire diameter you plan to use.</p> <p>ATTENTION! The device automatically reduces or increases its maximum power depending on the wire diameter.</p>
--	--

	<p>Step 5 Selecting the welding wire diameter</p> <p>You choose the welding wire diameter you plan to use.</p> <p>ATTENTION! The device automatically reduces or increases its maximum power depending on the wire diameter.</p>
---	--

C. MIG/MAG OPERATION



In MIG welding mode, the user sets all welding parameters one after the other. The system suggests the selection of optimal welding parameters by indicating at their adjustment thickness of the welded material (see table - setting the wire feeder speed). This information suggests to the user that the settings are correct. Depending on the welding style (forced positions, fast welding with higher current or slower current with lower intensity), these settings may require a slight adjustment by the user.



	<p>Handle mode button operation</p> <p>2-step, 4-step welding and spot welding selection.</p> <p>Choose spot and press button execute. It will go to next page to set spot on and spot off time.</p>
	<p>Pulse selection:</p> <ul style="list-style-type: none"> - continuous (without pulse) - single pulse (see chapter WELDING MIG / MAG WITH PULSE) - double pulse (see chapter WELDING MIG / MAG WITH DOUBLE PULSE)
	<p>Choice of welding wire diameter</p> <p>Choose the corresponding wire diameter. Aluminum material only allow weld 1.0/1.2mm. Carbon steel and stainless material allow 0.8/0.9/1.2mm wire.</p>

	<p>Choice of welded material (and wire)</p> <p>From the list of alloys available in program.</p>
	<p>Setting the wire feeder speed ATTENTION!</p> <p>It will show automatically the estimated thickness of the welded material in order to select the optimal welding parameter.</p>
	<p>Adjusting the arc voltage</p> <p>Increasing or decreasing this value will lengthen or shorten the arc length.</p>
	<p>Inductance regulation</p> <p>Properly selected welding inductance reduces the amount of spatter. It depends on the wire diameter welding, shielding gas used, current and welding position. Reducing the inductance makes the arc more stable and concentrated, while increasing contributes to the formation of a more fluid pool and reduces the amount of spatter. Properly selected, it is characterized by a stable arc, even transfer of liquid metal droplets, maintaining a constant weld pool size and characteristic repetitive sound without splashes and explosions.</p>

	<p>Adjusting the arc voltage</p> <p>Increasing or decreasing this value will lengthen or shorten the arc length.</p>
---	---

D. MIG / MAG WELDING WITH PULSE

In order to start welding in MIG / MAG PULS mode, the settings should be made as in the previous chapter. Additional welding parameters in pulse welding mode are presented in the following tables:

	<p>Welding current selection2</p> <p>The pulse current function is mainly used when welding thin elements, low melting metals, e.g. lead, or welding in forced positions. Other advantages of pulsating current welding are the smaller heat affected zone, greater welding arc stability,</p>
	<p>Pulse frequency adjustment</p> <p>Changing this parameter extends or shortens the welding arc.</p> <p>ATTENTION!</p> <p>The pulse frequency is automatically selected based on the other welding parameters, there is no need to manually correct it.</p>

	<p>Pulse cycle setting</p> <p>Adjusting this parameter causes increasing or reducing the amount of spatter during welding.</p> <p>ATTENTION!</p> <p>The pulse cycle value is automatically selected based on the other welding parameters, there is no need to manually correct it.</p>
--	---

E. MIG / MAG WELDING WITH DOUBLE PULSE

To start welding in MIG / MAG mode, double PULSES should be pre-set as in the BASIC MIG / MAG SETTINGS chapter. Additional welding parameters in mode double pulse current welding is shown in the table below:

	<p>Welding current selection 3 - double pulse</p> <p>Choose double pulse when welding aluminum.</p>
	<p>Selection of wire feeder speed ATTENTION!</p> <p>When adjusting this parameter, you can refer to the dynamic thickness data that shown on the left, until the data match with the real thickness of the work piece. or change a little bit as you need.</p>



Double pulse frequency setting In order to achieve optimal welding parameters, it is suggested to set the range from 1 to 2 Hz.



Double pulse cycle setting
In order to achieve optimal welding parameters, it is suggested to set the range from 30 to 40%.







Setting the minimum wire feeder speed
ATTENTION!

When adjusting this parameter, you can refer to the dynamic thickness data that shown on the left, until the data match with the real thickness of the workpiece. or change a little bit as you need.

To achieve optimal welding parameters, setting the value is suggested corresponding to 70 to 90% of the maximum feeder speed.

F. SAVE AND RECALL FUNCTION

The device is equipped with a memory bank that allows you to save 18 user programs. The method of saving and reading data stored in the device cache is described below:

 <p>The screenshot shows the 'MIG PARAMETER LIST' screen. At the top, there are two buttons: '3.5mm' and 'Save in job 18'. Below these are several parameter fields arranged in a grid:</p> <table border="1"><thead><tr><th>2T/4T</th><th>Pulse</th><th>Wire diameter</th></tr></thead><tbody><tr><td>2T</td><td>ON</td><td>1.2mm</td></tr><tr><th>Material selection</th><th>Feeding speed</th><th>Voltage</th></tr><tr><td>4</td><td>7.5</td><td>18.2V</td></tr><tr><th>Inductance</th><th>Pulse frequency</th><th>Pulse duty cycle</th></tr><tr><td>0%</td><td>192Hz</td><td>25%</td></tr><tr><th>MMA Current</th><th>Hot start current</th><th>Force current</th></tr><tr><td>100A</td><td>50A</td><td>50A</td></tr><tr><th>TIG Current</th><td></td><th>VRD</th></tr><tr><td>100A</td><td></td><td>OFF</td></tr></tbody></table>	2T/4T	Pulse	Wire diameter	2T	ON	1.2mm	Material selection	Feeding speed	Voltage	4	7.5	18.2V	Inductance	Pulse frequency	Pulse duty cycle	0%	192Hz	25%	MMA Current	Hot start current	Force current	100A	50A	50A	TIG Current		VRD	100A		OFF	<p>Holding the button  for 5 seconds will call the save page out, then select the job number and confirm to save job data</p>
2T/4T	Pulse	Wire diameter																													
2T	ON	1.2mm																													
Material selection	Feeding speed	Voltage																													
4	7.5	18.2V																													
Inductance	Pulse frequency	Pulse duty cycle																													
0%	192Hz	25%																													
MMA Current	Hot start current	Force current																													
100A	50A	50A																													
TIG Current		VRD																													
100A		OFF																													
 <p>The screenshot shows the 'MIG PARAMETER LIST' screen. At the top, there are two buttons: '3.5mm' and 'Call data from job 18'. Below these are several parameter fields arranged in a grid:</p> <table border="1"><thead><tr><th>2T/4T</th><th>Pulse</th><th>Wire diameter</th></tr></thead><tbody><tr><td>2T</td><td>ON</td><td>1.2mm</td></tr><tr><th>Material selection</th><th>Feeding speed</th><th>Voltage</th></tr><tr><td>4</td><td>7.5</td><td>18.2V</td></tr><tr><th>Inductance</th><th>Pulse frequency</th><th>Pulse duty cycle</th></tr><tr><td>0%</td><td>192Hz</td><td>25%</td></tr><tr><th>MMA Current</th><th>Hot start current</th><th>Force current</th></tr><tr><td>100A</td><td>50A</td><td>50A</td></tr><tr><th>TIG Current</th><td></td><th>VRD</th></tr><tr><td>100A</td><td></td><td>OFF</td></tr></tbody></table>	2T/4T	Pulse	Wire diameter	2T	ON	1.2mm	Material selection	Feeding speed	Voltage	4	7.5	18.2V	Inductance	Pulse frequency	Pulse duty cycle	0%	192Hz	25%	MMA Current	Hot start current	Force current	100A	50A	50A	TIG Current		VRD	100A		OFF	<p>Holding the button  for 5 seconds will call the recall page out, then select the job number to call out the remembered data.</p>
2T/4T	Pulse	Wire diameter																													
2T	ON	1.2mm																													
Material selection	Feeding speed	Voltage																													
4	7.5	18.2V																													
Inductance	Pulse frequency	Pulse duty cycle																													
0%	192Hz	25%																													
MMA Current	Hot start current	Force current																													
100A	50A	50A																													
TIG Current		VRD																													
100A		OFF																													

I. MIG Setting Chart

MIG Welding Current-Wire Diameter And Plate Thickness Chart							
Wire diameter	Plate thickness	1mm	2mm	3mm	4mm	5mm	6mm
AL-Si1.0/(4043) (DCEP)	Wire speed (M/min)	2.0	4.2	5.8	7.0	8.5	10.0
	Welding current (A)	24	58	85	107	133	160
	Arc voltage	16.0	18.3	19.2	21.0	22.5	23.6
AL-Si1.2/(4043) (DCEP)	Wire speed (M/min)	1.5	3.0	4.5	6.5	7.8	9.0
	Welding current (A)	27.0	64	100	143	173	200
	Arc voltage	16.5	17.8	19.5	22.5	24.5	25.3
Al-Mg1.0/(5356) (DCEP)	Wire speed (M/min)	2.5	6.0	8.0	11.0	12.5	14.0
	Welding current (A)	30	70	95	130	148	167
	Arc voltage	14.8	18.3	19.8	22.8	23.4	23.9
Al-Mg1.2/(5356) (DCEP)	Wire speed (M/min)	2.2	4.0	5.3	7.5	8.5	9.5
	Welding current (A)	33	65	89	128	141	152
	Arc voltage	15.7	17.2	17.7	19.3	20.0	21.2
AL1.0/(1070) (DCEP)	Wire speed (M/min)	2.8	5.3	7.0	8.5	10.0	11.3
	Welding current (A)	37	77	107	133	160	179
	Arc voltage	16.9	18.9	21.0	22.5	23.6	24.1
Al-Si 1.2/(1070) (DCEP)	Wire speed (M/min)	1.7	3.2	4.0	5.8	6.9	8.0
	Welding current (A)	30.0	68.0	88.0	127.0	152.0	178.0
	Arc voltage	16.7	18.0	18.8	21.6	22.9	24.9
Cu-Si1.0/(CuSi) (DCEP)	Wire speed (M/min)	4.0	9.0	12.0	14.0	16.0	18.0
	Welding current (A)	70.0	156.0	200.0	237.0	260.0	290.0
	Arc voltage	19.0	23.8	25.5	27.0	29.0	31.0
Cu-Si1.2/(CuSi) (DCEP)	Wire speed (M/min)	2.8	5.4	6.8	8.5	9.4	10.2
	Welding current (A)	72.0	153.0	194.0	220.0	241.0	264.0
	Arc voltage	19.7	23.5	25.6	28.5	29.6	30.8

Instruction: 4xxx means Al-Si wire, 5xxx means Al-Mg wire, 1xxx AL wire, Al and Al-Si wire both use Al-Si Function.

TIG Welding



In the TIG (Tungsten Inert Gas) method, the electric arc strikes under an inert gas (argon) shield, between the welded element and the non-fusible electrode made of pure tungsten or tungsten with additives.

The TIG method is especially recommended for aesthetic and high-quality joining of metals, without laborious mechanical treatment after welding. However, this requires proper preparation and cleaning of the edges of both welded elements. The mechanical properties of the additive material should be similar to the properties of the welded parts. The role of shielding gas is always played by pure argon, supplied in quantities depending on the welding current set.

Remote signal cable connect with 12 pin plug, make sure select remote function on display panel.

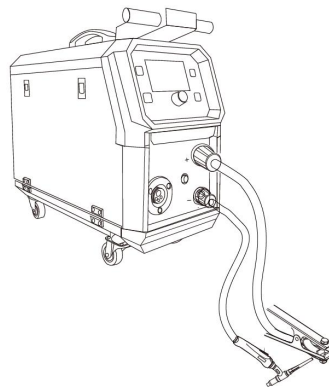

TIG DC WELDING



AC / DC welding current selection -select DC mode



Select operation mode on the right side
-select 2T/4T



Pulse or continuous current welding

description of pulse welding parameters is on page19)



Synergic mode / manual mode

In synergic mode, the user only need to adjusts the basic welding parameters. The device constantly checks the correctness of settings. Automactically suggest the plate thickness on the left.



Control of welding parameters panel/remoet control

potentiometer in the welding gun or pedal



Pre-flow-time before ignition of the arc

ATTENTION!

The welding arc will catch fire any time after the set gas flow time before welding. For a 4m long handle max. suggested time: 2 seconds



Start current - 4 clock mode

Take-off current should be 70 to 90% values of the basic welding current. It is used to avoid remelting and melting in the initial welding phase.



Up slope

Time at which the start current reaches the value of the main welding current.



Peak current
Basic welding current.



Down slope
Time at which the peak welding current will pass to the final current (crater filling).



Crater current
The final current should be 70 to 90% values of the basic welding current. It is used for the correct purpose end of weld in its final phase (crater filling). Very important when welding alloys aluminum.



Post Flow
Attention !
After the arc has expired, it should be keep the torch in the allowing position to cool the welded area with gas.



Welding parameters - summary chart

The screen shows all parameters welding selected by the user.

TIG PARAMETER LIST			Save JOB 18
AC/DC	2T/4T	Pulse	
AC	4T	ON	
AC Wave	AC Auto	Remote	
3	OFF	OFF	
Start current	Pre Flow	AC frequency	
30	4.0	60	
Peak current	Post Flow	AC balance	
250	3.2	21	
Base current	Up slope	Pulse frequency	
92	9	9	
Crater current	Down slope	Pulse duty cycle	
158	3	29	

Saving data in the device's memory

TIG PARAMETER LIST			Call JOB 18
AC/DC	2T/4T	Pulse	
AC	4T	ON	
AC Wave	AC Auto	Remote	
3	OFF	OFF	
Start current	Pre Flow	AC frequency	
30	4.0	60	
Peak current	Post Flow	AC balance	
250	3.2	21	
Base current	Up slope	Pulse frequency	
92	9	9	
Crater current	Down slope	Pulse duty cycle	
158	3	29	

Using saved programs

TIG DC (direct current) welding is used for welding all types of steel, alloys copper and some non-ferrous metal alloys. A distinction is made between DC negative and DC + positive polarity welding on a TIG welding torch. Most welding work is carried out using DC negative polarity (used for welding e.g. carbon steel, alloy steel, titanium, nickel, etc.)

The use of DC + positive polarity is recommended for welding zinc, copper and its alloys (bronzes, brass). However, it should be remembered that the use of positive polarity causes high wear fusible electrode.

Table 4. Heat distribution and its impact on DC TIG welding process

Polarity	Negative (DC-)	Positive (DC+)
Penetration	Deep and narrow	Shallow and wide
Efficiency heat electrode	Very good	BAD - high wear
Heat distribution	70% - material	30% - material
	30% - electrode	70% - electrode

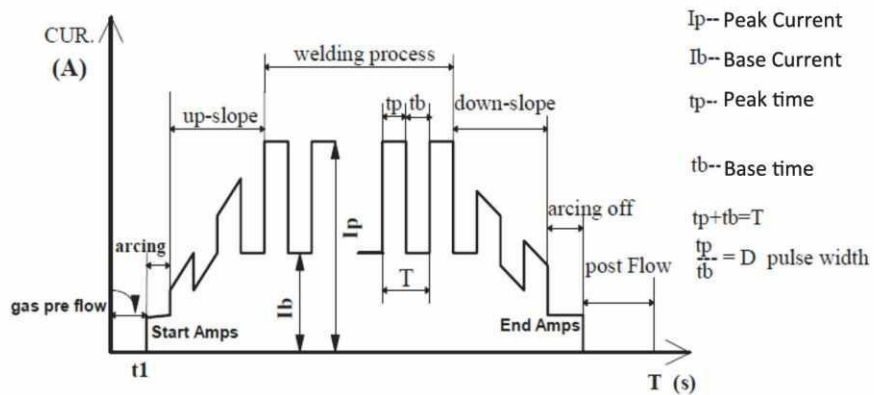

WELDING PULSE WELDING - TIG PULSE

Lynx 3 TIG welding process -PULSE



SETTING OF THE TIG PULSING WELDING

Pulse or continuous current welding
Select the pulse mode

 <p>The screenshot shows the 'TIG SETTING' menu. The 'Current' is set to 250 A and the electrode diameter is 6.2 mm. The 'Pulse duty cycle' is highlighted in blue and set to 29%. The 'Parameter list' on the right includes Start current, Up slope, Peak current, Pulse duty cycle, Pulse frequency, Base current, and Down slope. At the bottom, 'Power mode' is AC, 'Operation mode' is 4T, 'Pulse mode' is ON, and 'Remote' is OFF.</p>	<p>Select the pulse mode</p> <p>The parameter specifies the time proportion between welding with peak current in relation to the base current.</p>
 <p>The screenshot shows the 'TIG SETTING' menu. The 'Current' is set to 250 A and the electrode diameter is 6.2 mm. The 'Pulse frequency' is highlighted in blue and set to 9 Hz. The 'Parameter list' on the right includes Up slope, Peak current, Pulse duty cycle, Pulse frequency, Base current, Down slope, and Crater current. At the bottom, 'Power mode' is AC, 'Operation mode' is 4T, 'Pulse mode' is ON, and 'Remote' is OFF.</p>	<p>Pulse frequency</p> <p>Parameter specifying the number of changes between the peak current value and the base current value in one second.</p>

ALTERNATING CURRENT WELDING-TIG AC

TIG AC (AC) welding is used to connect magnesium or aluminum components and their alloys.

During AC welding, polarity changes between the poles positive and negative. A positive halfwave allows the oxide surface layer to penetrate, while a half-wave negative, which is accompanied by a decrease in the temperature of the electrode and heat flow to the workpiece, promotes deeper arch penetration. By adjusting the AC wave balance, you can fine-tune the proportions between spreading and penetrating electric arc.

For TIG AC welding, the most common electrode is pure tungsten (green) or tungsten with the addition of lanthanum (gold color - recommended for low welding currents); preparation of the electrode consists in appropriate blunting of the tip, which under the influence of high temperature and electric arc takes a gradually rounded shape.

Both argon and helium can play the role of shielding gas in this welding method. generally however, argon is used because it is cheaper and produces a more stable arc, which translates into for greater maneuverability. However, it works better with some types of welds helium or a mixture of helium and argon, which in addition to higher welding speeds also allows deeper penetration.



Welding current selection Select a mode AC



Selection of the handle button operating mode
2T/4T



Pulse or continuous current welding



Synergy mode / manual mode In synergic mode the user regulates only basic welding parameters. The device constantly checks the correctness settings, suggesting the user thickness material to be welded (see screen for current). In manual mode all parameters welding are manually adjusted by user.



Control of welding parameters from the panel / remote control

(potentiometer in welding gun or pedal)



Selection of AC wave form:

1. Square Wave
2. Sine Wave Triangular
3. Ramp Wave
4. Triangular growing
5. Triangular sloping
6. Trapezoidal wave



Pre-flow

Attention !

The welding arc will catch fire any time

after the set gas flow time before welding.
For a 4m long handle max. suggested time:
2 seconds.



Welding peak current

Basic welding current

ATTENTION !

The characters in the top frame match
suggested thickness of welded material.



AC balance

Parameter specifying the heat ratio carried between the electrode tungsten and welded material. It enables welding of thin elements in the case of heat transfer on the electrode or reaching a larger one remelting in a heat transfer situation from the electrode to the workpiece. See description page 25.



AC frequency

Number of voltage and current changes AC welding in one second.



Post flow

Attention!

After the welding arc has expired, keep the torch in a position that allows the welding area to cool down with shielded gas.



Welding parameters-summary graph

The screen shows all welding parameters selected by the user.

TIG PARAMETER LIST		
AC/DC	2T/4T	Pulse
AC	4T	ON
AC Wave	AC Auto	Remote
3	OFF	OFF
Start current	Pre Flow	AC frequency
30	4.0	60
Peak current	Post Flow	AC balance
250	3.2	21
Base current	Up slope	Pulse frequency
92	9	9
Crater current	Down slope	Pulse duty cycle
158	3	29

Saving data in the device's memory

TIG PARAMETER LIST		
AC/DC	2T/4T	Pulse
AC	4T	ON
AC Wave	AC Auto	Remote
3	OFF	OFF
Start current	Pre Flow	AC frequency
30	4.0	60
Peak current	Post Flow	AC balance
250	3.2	21
Base current	Up slope	Pulse frequency
92	9	9
Crater current	Down slope	Pulse duty cycle
158	3	29

Using saved programs

AC Balances settings

AC balance is the ratio of the positive current t_{bal+} to the negative t_{bal-} current in a single cycle

T_{bal} alternating current waveform. The ability to adjust the balance allows you to control the temperature of the electrode and the workpiece, including the welder has an effect on the depth of penetration and the width of the weld. In a situation where balance is positive (longer duration t_{bal+} compared to the duration t_{bal-}) the electrode heats up faster than welded material - we get less penetration. In a situation where the balance is negative (longer duration t_{bal-} in relation to t_{bal+}), the electrode heats up more slowly than the welded material - we get more penetration.

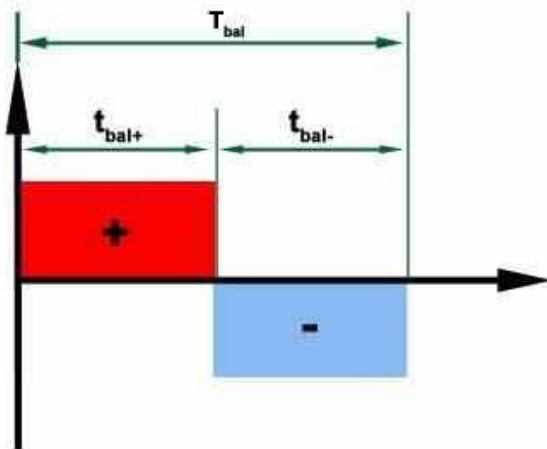

Turning the adjustment dial to the left and setting the AC Balances below 50 will reduce the time

t_{bal+} duration and proportional extension of the t_{bal-} duration Fig.

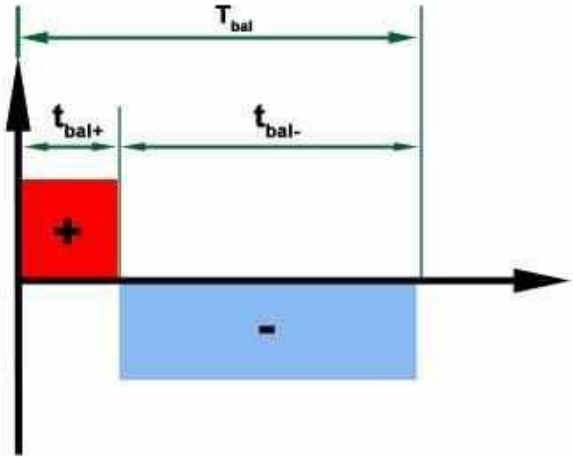

Turning the control knob to the right and setting AC Balances above 50 will shorten duration t_{bal-} i proportional increase in duration t_{bal+}

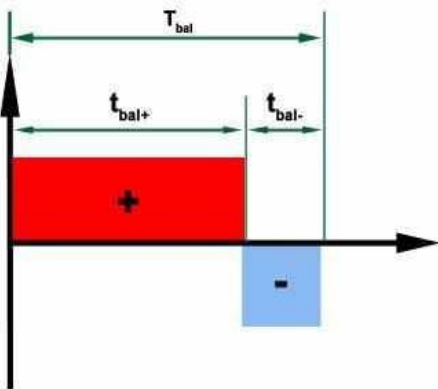

MMA WELDING





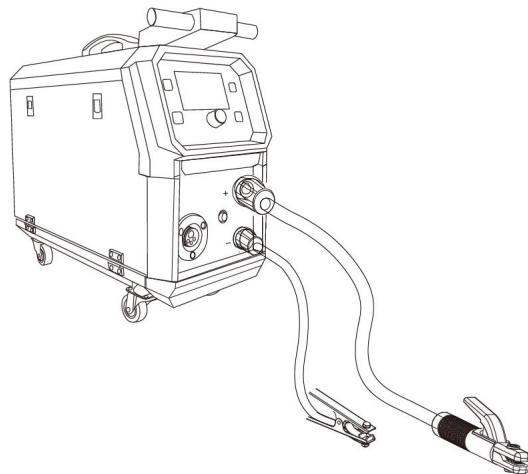

Arc welding is also called the MMA (Manual Arc Welding) method and is the oldest and most versatile arc welding method.

The MMA method uses a coated electrode, consisting of a metal core covered with a lagging. An electric arc is created between the end of the electrode and the material being welded. Arc ignition is created by touching the electrode with the end of the work piece. The welder feeds the electrode as it melts into the work piece so as to maintain a constant arc length and at the same time moves its melting end along the welding line. The melting coating of the electrode gives off protective gases that protect the liquid metal from the influence of the surrounding atmosphere, and then solidifies and forms a slag on the surface of the lake, which protects the coagulating weld from cooling too quickly and harmful environmental influences.





Connect the welding and mass leads to the appropriate output connectors of the welder, according to the polarity recommended by the manufacturer of the electrodes you intend to weld.

	<p>Welding current setting</p> <p>Adjust the welding current by spin the knob.</p>
	<p>HOT-START</p> <p>A function that makes welding easier. When the arc strikes, the welding current is temporarily increased to heat up the material and electrode at the point of contact, and to properly shape the penetration and weld face at the initial stage of welding.</p>
	<p>ARC FORCE</p> <p>Stabilizes the arc regardless of fluctuations in its length, reduces the amount of spatter.</p>
	<p>VRD</p> <p>The device has a VRD (Voltage Reduction Device) system, which significantly increases user safety. VRD is always on in this model.</p>

8. ERROR CODE

In special cases, the following messages may appear on the display indicating a problem with the operation of the device. Errors on the display will appear until the defect is removed.

 The image shows a digital display with a dark background. At the top, the word "WARNING" is written in white. Below it, "ERROR 001" is displayed in white. A red horizontal bar contains the text "OVER CURRENT" in white. To the right of the bar is a circular red icon with a white lightning bolt.	<p>Error 001 Over current</p> <p>The device is operated beyond its rated efficiency. This message may also appear if you use an extension cord with the wrong diameter. After this message appears, turn the devices off for 5 minutes. If this message still appears after switching it on again, contact</p>
 The image shows a digital display with a dark background. At the top, the word "WARNING" is written in white. Below it, "ERROR 002" is displayed in white. A red horizontal bar contains the text "OVER HEAT" in white. To the right of the bar is a circular red icon with a white thermometer and a degree symbol.	<p>Error 002 Over heat</p> <p>The device is equipped with overheating protection. If the installed sensors find the temperature too high (e.g. fan failure or blocking), the device will switch off automatically and this message will appear</p>
 The image shows a digital display with a dark background. At the top, the word "WARNING" is written in white. Below it, "ERROR 003" is displayed in white. A red horizontal bar contains the text "FEEDER PLUGGING" in white. To the right of the bar is a circular red icon with a white symbol of a wire being blocked by a red 'X'.	<p>Error 003 Wire feeder plugging</p> <p>The message appears when the wire in the feeder is blocked. This can happen when using 0.8mm wire when welding aluminum alloys.</p>

9. ELECTRICITY SAFETY GUIDELINES

WORKING CONDITIONS

Optimal ambient temperature between -10 ° C and 40 ° C.

Avoid welding in sunny conditions and when it is raining, do not allow water to get inside the device. Avoid working in flammable, aggressive or dust environments.

WORK SAFETY

Properly installed device with over voltage, over current protection and protection against excessive temperature will automatically turn off under conditions beyond those specified as standard.

However, prolonged use (e.g. over voltage) may damage the welding machine.

Therefore, the following guidelines should be followed:

PRECAUTIONS

1) Ensure good ventilation

The welder is a small device, through which a large current flows, and natural ventilation does not provide the necessary cooling. Therefore, to maintain stability, the welder is equipped with an internal cooling system. The operator should check that the ventilation opening is not blocked. The distance between the welder and the work piece should not be less than 0.3m. The operator should always pay attention to the ventilation of the device, because it depends not only on the obtained quality and welding results, but also on the service life of the device.

2) Preventing overloading

Operators should observe (the load determined as the maximum permissible load for a given current) whether the welding current does not exceed the highest electric current permissible for the load. Electrical overload can significantly reduce the service life of the welder and even lead to the burning of its components.

3) Over voltage prevention

The values given in the supply voltage line in the "Technical data" table should be kept. Under normal operating conditions, the automatic voltage compensation circuit ensures that the voltage remains within the permissible range. Supply voltage higher than the permissible value may damage the welder.

Operators should be fully aware of this threat and be able to take the appropriate steps.

4) If the standard load is exceeded, the welder can enter protection mode and suddenly stop working.

This means that the standard load has been exceeded, thermal energy has tripped the thermal switch, which caused the device to stop. The indicator light on the welder's control panel lights up. In this situation, do not unplug the power plug to allow the fan to cool the welding machine. Turning the lamp off means that the temperature drops to a normal level. You can continue working.

