



divinefloor.com

For more information, please contact your DIVINE Flooring Authorized Dealer or consult our website.

If the authorized dealer is unable to resolve your inquiry,

please contact our Technical Services Department at DIVINE Flooring directly by email or phone.

DIVINE FLOORING

Attn: Technical Services Department

CANADA

235075 Ryan Road, Rocky View, Alberta, Canada, T1X 0K3

USA

222 Merchandise Mart Plaza Suite 105-B Chicago, IL 60654

Phone/Fax: 1 844 6 DIVINE (34 8463)

Email: technical@divinefloor.com divinefloor.com

Quest - Luxury Vinyl Plank • Installation Instructions

Applicable on all Divine branded luxury vinyl plank with SPC (Stone Plastic Composite) core and integrated HDPE underlayment with Drop Lock Profile

Please read all instructions carefully before attempting installation.
Improper installation may void the warranty.

PRODUCT USE

Quest may be installed above, on or below grade in a floating installation method or it may be installed on or above grade in a glue down installation.

The acceptable subfloors are plywood/OSB, concrete subfloor, or simply over an acceptable smooth, single layer, hard surface existing floor covering such as: Ceramic Tile, Resilient Tile, Sheet Vinyl, wood and laminate floors which are flat, clean, in good condition and well-bonded to subfloor.

Quest features a Drop Lock profile on the length and ends, for an easy and fast Floating Installation method.

Floating Installation saves you labor and material costs, eliminating nails/staples, adhesive, solvent and cleaning; it also cuts down on board installation time and allows you to walk on your floor immediately after work completion.

INSTALLER AND OWNER RESPONSIBILITY

Prior to installation, the installer and owner must ensure that the work environment and subfloors meet or even exceed minimal specifications listed in this installation guide.

Standard trade practice allows for up to a 5% margin of error for imperfections and minor manufacturing defects. Prior to installation, the installer and owner should conduct a final inspection of products, for color, finish, sheen and manufacturing quality of planks to ensure that the floor conforms to purchased product.

Once installed, any planks are considered as having been accepted by installer and owner, even if owner is absent at time of installation. When ordering Quest, it is recommended to order an additional 5% square footage for allowance of cutting waste.

WARRANTY

Structural Limited Residential Warranty.

DIVINE Flooring guarantees the original purchaser a 25 Years (Twenty-five) limited warranty on the structure of the flooring planks. The residential warranty is valid if the site environmental conditions are met, including and maintaining recommended temperature and relative humidity. Subfloor pre-installation evaluation, moisture content level requirements, subfloor preparations and subfloor leveling must all meet DIVINE Flooring requirements specified in this document.

FLOOR CARE PREVENTION TIPS

For information on floor care protection, prevention and maintenance, consult DIVINE Flooring Luxury Vinyl Flooring Maintenance Instructions on our website divinefloor.com.

NOTE: Quest has an integrated HDPE underlayment that will help to correct minor subfloor imperfections, provides acoustical comfort (sound abating properties) and underfoot comfort. It is also suitable for use with radiant floor heating.

RECOMMENDED TOOLS, MATERIAL AND ACCESSORIES

(Floating Installation)

- Vacuum cleaner or broom
- Scraper
- Safety glasses
- Rubber mallet
- Tapping block
- Flat pull bar
- Square 16" x 24"
- Measuring tape
- Chalk line
- Pencil
- Utility knife
- Leveling bar
- Level
- Leveling compound [optional]
- #20 grit sand paper [optional]
- Wood and/or concrete moisture meter
- Drill
- Hand saw
- Miter saw [optional]
- Jig saw
- Expansion wedges or spacers
- SURFACELIFT™ maintenance kit

RECOMMENDED TOOLS, MATERIAL AND ACCESSORIES

(Glue Down Installation)

In the case of a glue down installation, the following additional items are required:

- Recommended Adhesive: Use Bond™ Flex Adhesive
- Use Bond™ notched trowel #2 (1/8" x 1/8" x 1/16"). Spread rate is up to 90 sq. ft / gal.
- 100 to 150 lbs [45 to 68 kg] roller

Transition accessories including reducers, t-molding and quarter rounds are available from your DIVINE Flooring retailer or authorized dealer and at DIVINE Flooring Showroom Locations.

Note: Quest may be installed with a direct glue-down method on approved wood subfloor or concrete subfloor. Use only Bond™ Flex - multipurpose flooring adhesive for Quest as per consultation with Divine Authorized Dealer for suitable material selection.

Note: DIVINE Flooring cannot be held responsible for any floor damage resulting from use of inadequate tools or accessories, differing from those recommended

HANDLING AND ACCLIMATION

The Installation of Quest planks does not require acclimation. However, it is recommended to install in rooms with temperatures between 55°F & 90°F (13°C & 32°C). The HVAC system must be on and functional before, during and after installation. Product should be stored horizontally in a dry area away from direct sunlight. Do not leave next to heat or cooling ducts. Allow the product to reach room temperature before installation.

Do not install Quest planks where they will be exposed to temperature greater than 140°F [60°C].

PRE-INSTALLATION CHECK LIST / BASIC REQUIREMENTS

- Ensure that all trades have been completed to eliminate dry wall dust, paints, etc.
- To avoid any moisture related damages, subfloor must be dry and basement well ventilated.
- For below grade installation, ensure that foundations, concrete slab or any adjacent objects are thoroughly leak proof. Surface drainage directing water away from the house or building. All gutters and downspouts should be in place.

OVER RADIANT HEAT INSTALLATION

Installation over subfloors equipped with radiant heat systems is possible. The radiant heat components must have a minimum of ½" (13 mm) separation between the flooring product.

The radiant heat system must have been tested and in operation for 45 days prior to installation. The flooring surface temperature should never exceed 85°F [30°C]. Use of an in-floor temperature sensor is recommended to avoid overheating.

If you glue down the Quest planks over a radiant heat system, you must make sure the radiant heat system is embedded into the subfloor.

- Turn off the heat for 24 hours before, during and after installation
- Floor temperature is raised gradually after installation, in 5-degree increments per day and must never exceed 85°F (30°C)

Warning: Electric heating mats must be embedded into the subfloor underneath Quest planks. Such use could void the warranty for your floor in case of its failure.

SUBFLOOR MOISTURE LEVEL EVALUATION

Quest planks are water/moisture resistant; however, excessive moisture in the subfloor may promote mold, mildew, and other moisture related issues like the trapping of moisture emissions under the flooring, which may contribute to an unhealthy indoor environment.

Wood Subfloor:

Wood subfloor moisture reading must not exceed 10%. Wood moisture meters are available at DIVINE Flooring Showroom locations and from your DIVINE Flooring Authorized dealer. If moisture reading is too high, postpone installation, find moisture source and correct it. If needed, raise heat and increase ventilation until proper subfloor conditions are met.

Concrete Subfloor:

Prior to installation, concrete subfloor should preferably be 45 to 90 days old. Concrete moisture meter must be used to check subfloor moisture level; if the

results exceed 3.5%, calcium chloride test must be performed. The concrete subfloor moisture content must not exceed 3 lbs / 1,000 sq. ft / 24 hours. If the reading exceeds 3 lbs, use a complete moisture-proofing system [sealer and adhesive] compatible with the selected adhesive.

Please refer to the manufacturer's documentation for the selected products for information on their warranty, product limitations, and installation recommendations.

Owner and installer are solely and jointly responsible for pre-installation subfloor moisture level evaluation and must ensure that all conditions and/or specifications listed in this guide have been thoroughly met prior to installation of Quest planks.

SUBFLOOR PREPARATION

All subfloors must be structurally sound, flat, dry and clean. The correct preparation of the subfloor is a major part of a successful installation.

Structurally Sound: Thoroughly inspect and replace existing floor or subfloor that shows evidence of water damage or structural weakness. Concrete subfloor must be just as structurally sound before installing Quest planks and should be rated with a minimum compressive strength of 3000 psi.

Level / Flat: Subfloor surface must be flat and maximum tolerance is 3/16" [5 mm] per 10' [3 m]. Subfloors should not slope more than 1" [2.5 cm] per 6' [1.8 m] in any direction. Voids or humps may prevent Quest planks from locking properly. If necessary, flatten down any irregularities and high spots, using #20 grit paper, and fill low spots with a high-performance self-leveling compound to correct any uneven spots.

Dry: Subfloor must be dry and within moisture reading specifications.

Clean: Scrape, broom clean, vacuum and free subfloor from any debris or obstacles such as carpet staples, adhesive residue, or any other materials to ensure proper installation.

OVER EXISTING FLOOR COVERING

Existing sheet vinyl floors should not be heavily cushioned and should not exceed more than one-layer thickness. Installation is NOT allowed over any type of carpet.

Note: If you are laying Quest over existing plank, an existing floor that has heavy embossing and grout line, etc. it will be necessary to skim coat the grout lines or the embossing with a floor leveler.

INSTALLATION PREPARATION

- Sketch your installation to avoid surprises. Decide starting point or wall.
- Remove any quarter round, baseboard, doorsill and old floor covering, when necessary.
- Trim bottom of the doorstop with handsaw to insert boards underneath.
- To enhance the floor's look, work installation from several boxes (i.e. 3 to 5 boxes) of flooring at the same time, and mix planks to ensure good variations in textures, colors and shades, and to arrange them in harmonious pattern.

NOTE: Use only glue down method for installation on stairs and vertical surfaces.

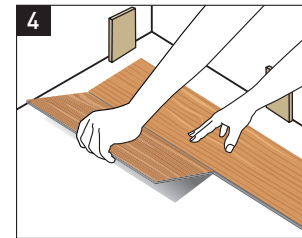

STEP 4 FIRST PLANK, SECOND ROW

Cut the first plank in the second row to one-third its length before installing it. Insert the long tongue edge of the plank into the long groove edge of the first plank. Make sure there are no gaps. Tap along the long groove edge using a tapping block and rubber mallet.

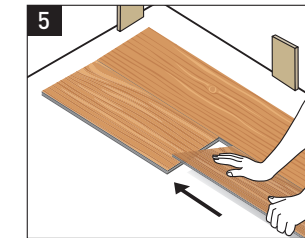
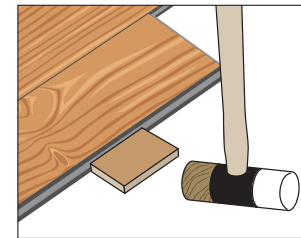

STEP 5 SECOND PLANK, SECOND ROW

Insert the long side, then slide the plank until the short tongue touches the short groove edge on the first plank of the second row. Press the short joint with a rubber mallet. Square the joint buy tapping the long edge of the plank using a tapping block.

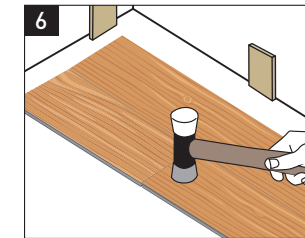

STEP 6 SECOND PLANK, FIRST ROW

Select a full plank and position the long groove edge into the tongue of the second plank in the second row. Press, tap and square as before. Repeat the same installation pattern until you reach the opposite wall and cannot install another full plank.

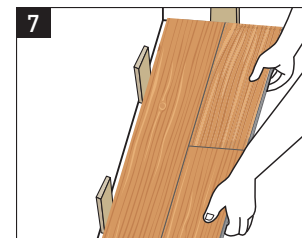

STEP 7 INSTALL THE LAST OF ROWS 1 AND 2

Cut to fit, maintaining the expansion gap. Install as before. Move the entire assembly against the spacers on the starting wall.

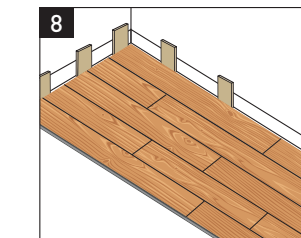

STEP 8 INSTALL REMAINING ROWS

Install the remaining material, one row after the other. Always press, tap and square as you go, and maintain the required stagger throughout the install.

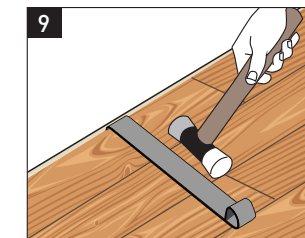

STEP 9 INSTALL THE LAST ROW

Cut the final row of planks to fit along the wall. Use a pull bar to lock the long edges together. Do not use the pull bar on the short edges.



T-MOLD

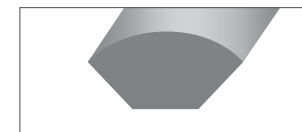

QUARTER ROUND

STEP 10 FINISH THE JOB AND INSTALL ACCESSORIES

Remove spacers. Cover expansion space with quarter round or other trim, being sure not to trap or pin down the floor.

NOTE: Rooms larger than 80 feet in length require the use of coordinating T-molding transitions.

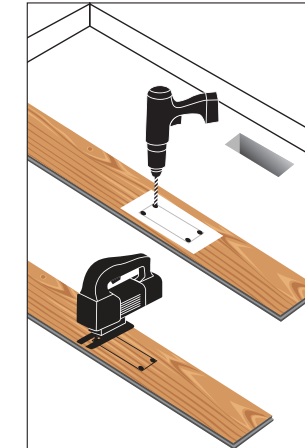

TIP: FITTING AROUND IRREGULAR OBJECTS

Simply make a pattern out of heavy paper to fit around pipes or irregular objects. Place the pattern on the plank and trace. Drill holes along the perimeter and using a jig saw, saw out the pattern by cutting from one vertex to the next. Be sure to leave a minimum of 1/4" (6 mm) expansion space around all fixed objects, cabinetry, and metal door jams. Undercut wooden door jams. Fill any expansion spaces around potentially wet areas such as refrigerators, tubs, and appliances with premium waterproof 100% silicone.

FLOATING INSTALLATION INSTRUCTIONS – DROP LOCK SYSTEM

Wear your safety equipment and maintain a safe environment at all times

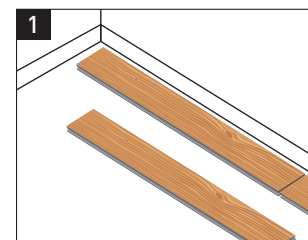

STEP 1 SET SPACERS

Create the required expansion space between the perimeter planks and the wall using spacers. Place spacers equaling the thickness for required expansion between plank and wall on short and long ends of plank. Do not remove them until the installation is complete.

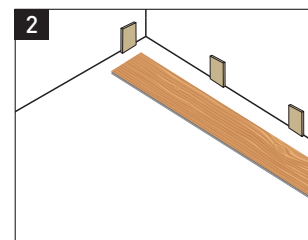

STEP 2 INSTALL FIRST PLANK

Position the first plank against a spacer a few inches from the starting wall.

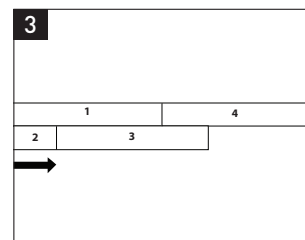

STEP 3 ESTABLISH PROPER STAGGERING

Maintain a minimum 6-inch end-joint stagger from row-to-row throughout the entire installation. The products should be staggered in a bricklaid pattern with stagger equal to ½ of a plank. Installation alternates back and forth between rows one and two for the first two rows only.

GLUE DOWN INSTALLATION INSTRUCTIONS

For glue down installations, spread the adhesive with the appropriate notched trowel. Avoid excessive adhesive thickness by passing the trowel evenly through the adhesive at a 45-degree angle. Observe the appropriate flash time (if applicable). Lay the flooring into the adhesive, correctly position it and press down firmly. Be sure to check the back of the flooring to make certain good adhesive transfer from sub floor to flooring is achieved. Roll flooring approx. 30 min after installation with a 100 – 150 lb roller Push down raised edges approx. 30-60 min after installation.

POST-INSTALLATION

Set a few boards aside in case of future repairs. In order to protect the floors while other trades are finishing their work prior to final cleanup, use Coverwalk™ and ONLY use 3M ScotchBlue 2080 Tape to hold to the Coverwalk™ along the perimeter. When installation is completed, vacuum floor thoroughly, spray light mist of DIVINE Flooring RENU Cleanser on terry cloth mop and wipe clean the floor. Install flooring protection in door entrance and under appliances and furniture, before moving into place. Furniture and appliances should be moved with hand truck or hand dolly over hardboard or plywood runways. Never slide appliances or other heavy furniture across the floor. Caster wheeled chairs should have wide, rubber casters. Oil and petroleum-based products can result in surface staining. Avoid exposure to long periods of direct sunlight. Floor covering subjected to excessive heat and light is subject to thermal degradation.