

**pureal** global

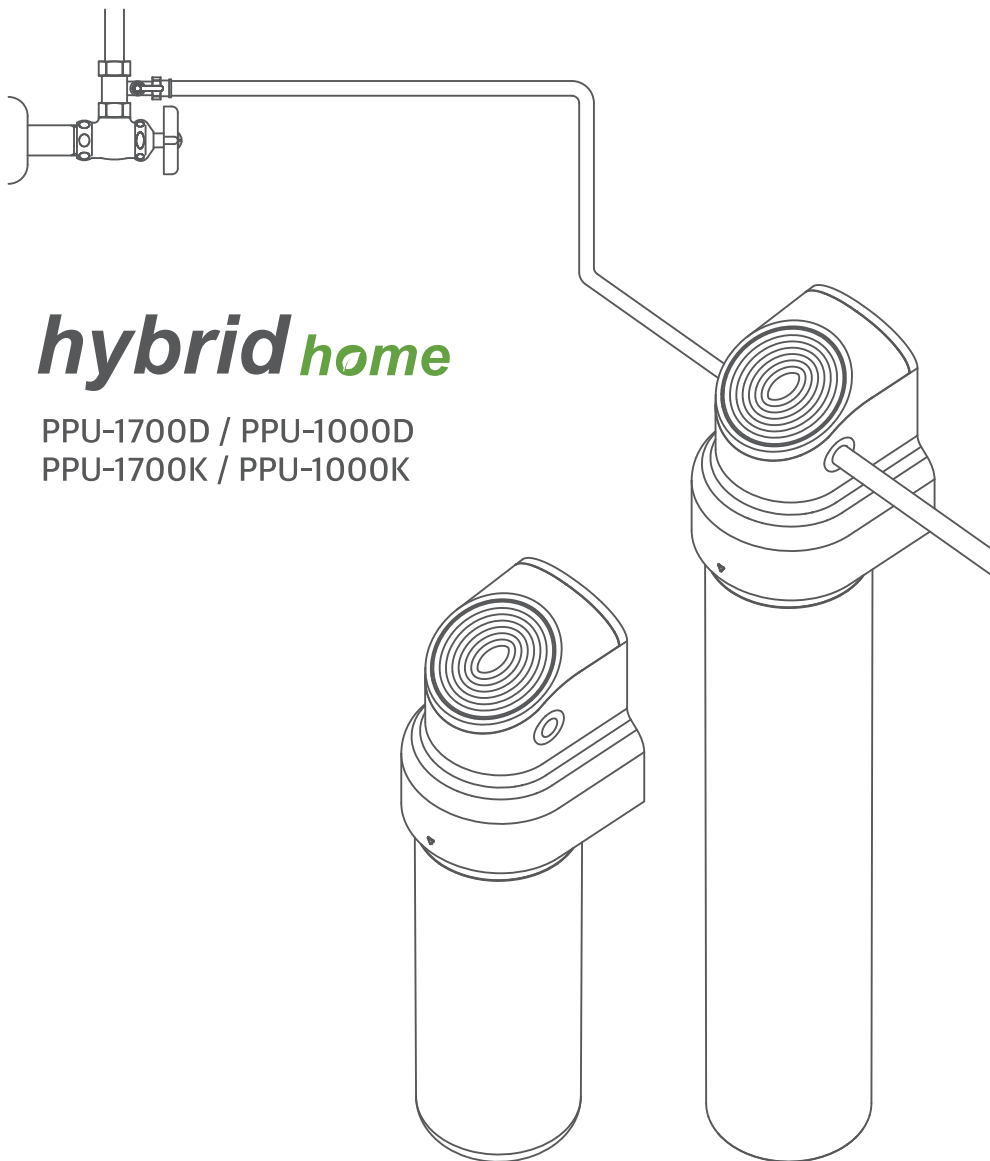

System Tested and Certified by NSF International against NSF/ANSI Standard 42 for the reduction of Chlorine and NSF/ANSI 372 for  $\leq 0,25\%$  lead.



# *hybrid* home

PPU-1700D / PPU-1000D

PPU-1700K / PPU-1000K



**Caution** If not followed, it would cause the minor injury or damage on the fortune.



**Warning** If not followed, it would cause the serious injury or damage on the fortune.



## Warning

- Do not disassemble or upgrade by yourself it would be the main reason of the malfunction.
- Do not remove the filter during the operation.  
It would cause the malfunction on the product by the water pressure.



## Caution

- Do not install on the uneven surface, and do not give the huge pressure or damage to the product.
- Installation must comply with applicable state and local laws.
- Please lock the feed water valve if the water purifier is not used for a long time, Especially during the vacation period, the high pressure could damage the product.
- Please exchange the filters on time to maintain the best quality of drinking water. The pacification performance could be affected if the filter's exchange period is over.
- Please take the extra care for the tube when the filter/water purifier is moved. The tube could be disconnected or damaged.
- If the leakage is found, please close the feed water valve.

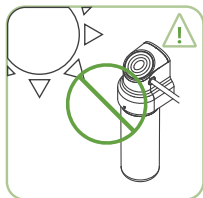

Please avoid the direct sunlight. It could cause the discoloration.

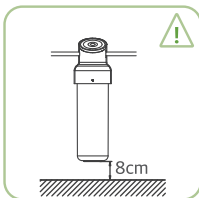

Please keep the space from the bottom (at least 8cm) and the tube length from the feed water valve must be less than 4 meters.



Please keep the temperature not to going down to 0 Celsius. It could cause the damage in the water tube and filter by frozen water.

## ◉ Manifold & Filter

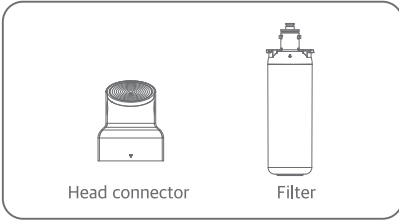

- If other accessories are required during the installation, the proper certified parts are required for the installation for your safety & the regulation of drinking water.

Interchangeable with Everpure filters (QL3B, QL3 heads)

### Drinking water faucet type [PPU-1700D / PPU-1000D]

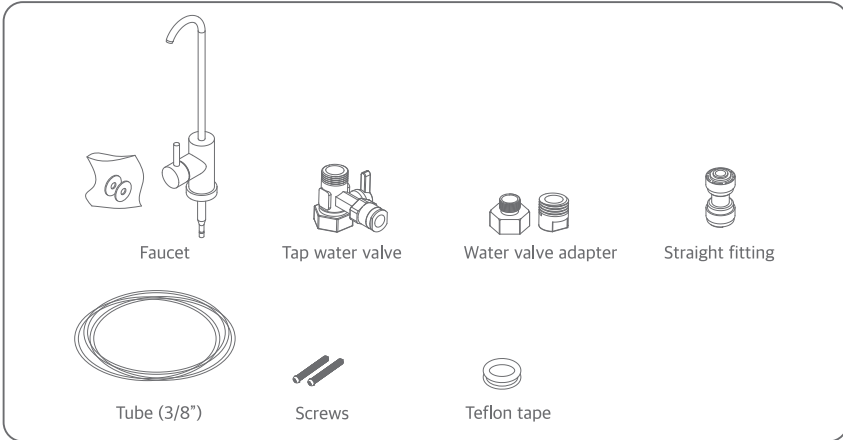

### Kitchen faucet type [PPU-1700K / PPU-1000K]

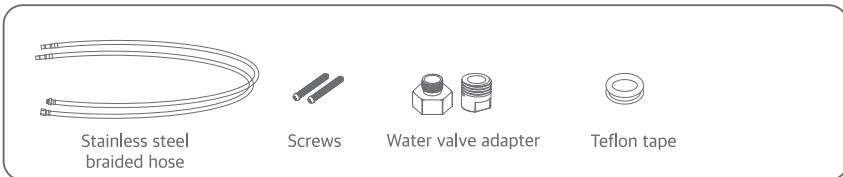

※ Installation Kits & Accessories are not NSF certified

- Drinking water faucet type [PPU-1700D / PPU-1000D]

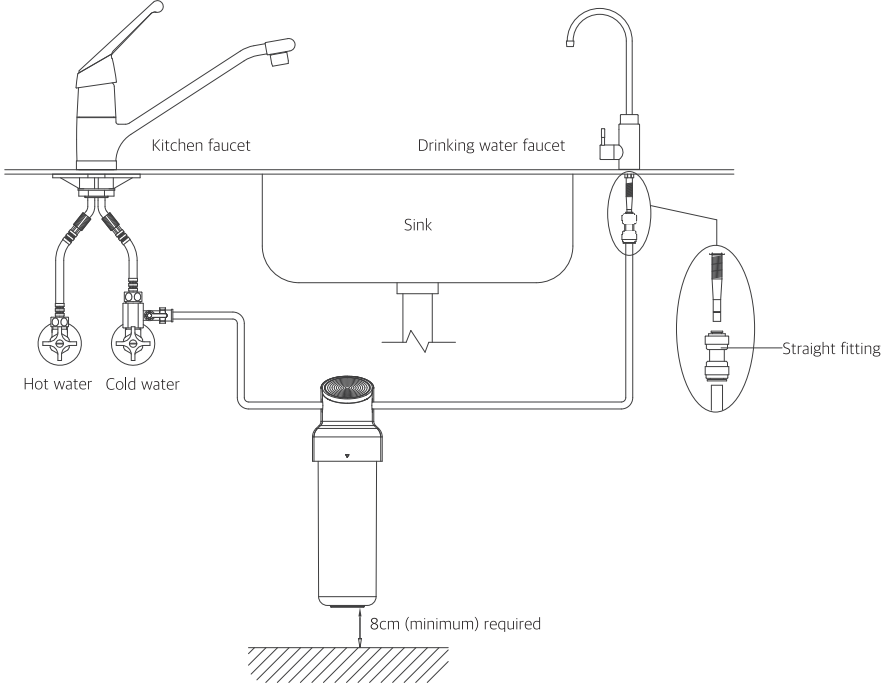

- Kitchen faucet type [PPU-1700K / PPU-1000K]

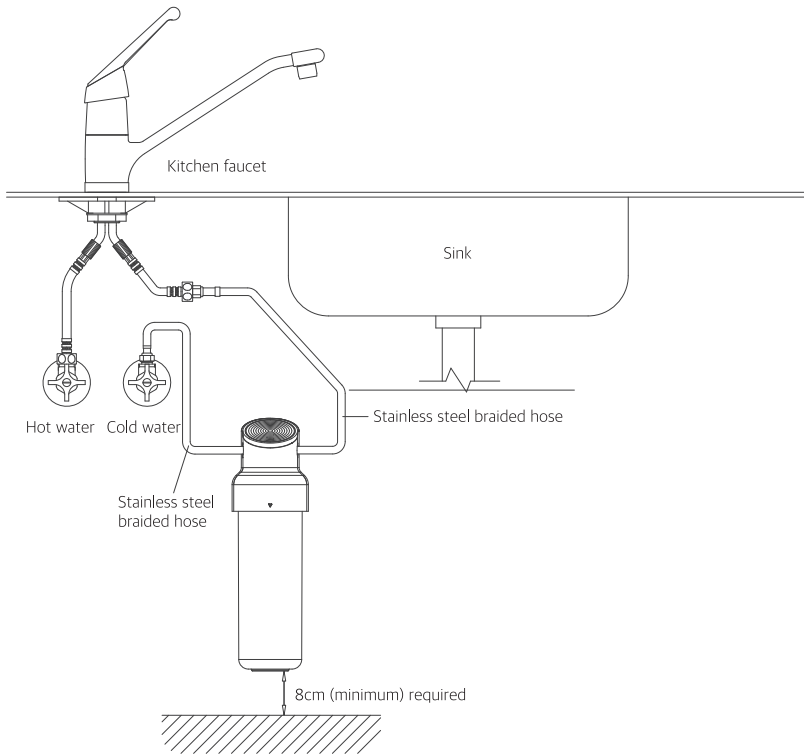

## Head connector installation

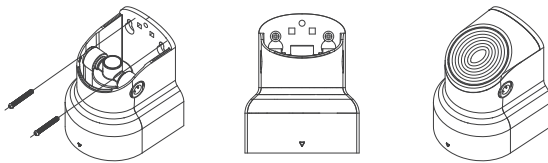

1. Please install the product on the even surface.
2. Use the drill or screwdriver to suspend the manifold.
3. Please keep the 8cm distance from the floor to the filter bottom.
4. Please install the product at no longer than 4m distance from tap water supply valve.

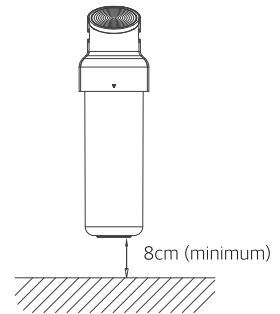

## Faucet installation

※ Drinking water faucet type only [PPU-1700D / PPU-1000D]

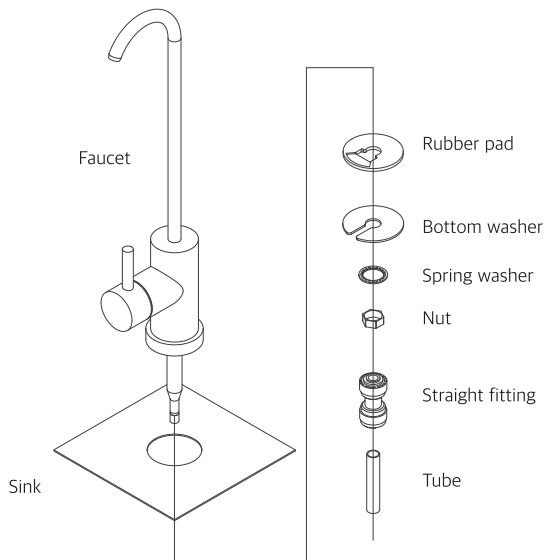

If there is no hole on the sink, need to make a hole by a drill.

## ● Tap water connection

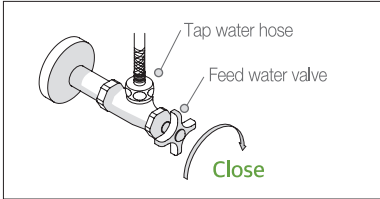

1. Please close tap water supply valve.
2. Disconnect tap water hose.

\* Cold water connection only

### Drinking water faucet type [PPU-1700D / PPU-1000D]

Please use enclosed water valve adapters, if you can not connect tap water valve to the tap by different thread size.

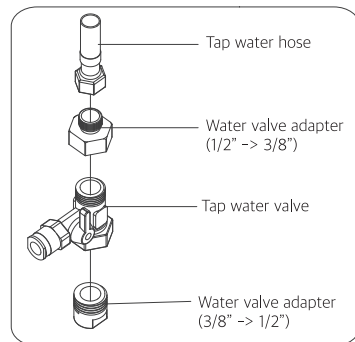
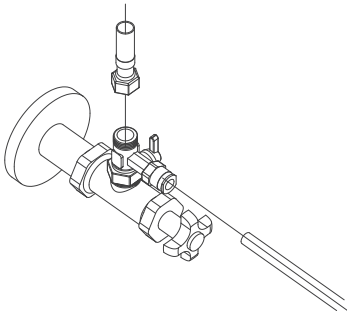

### Kitchen faucet type [PPU-1700K / PPU-1000K]

Please use enclosed water valve adapters, if you can not connect tap water valve to the tap by different thread size.

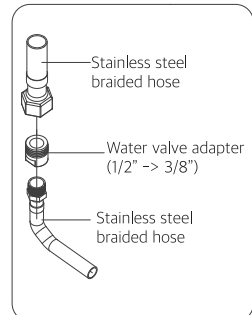
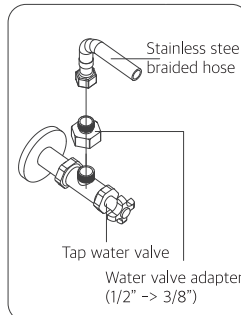
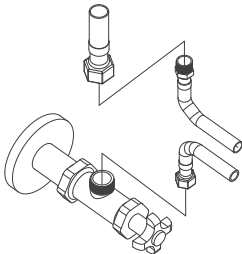

※ Please check the rubber rings in each connection



## ● Hose connection

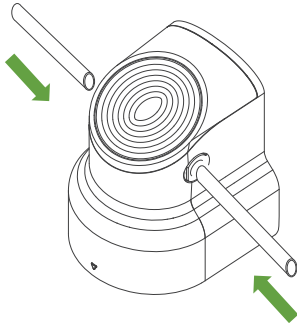

Connection

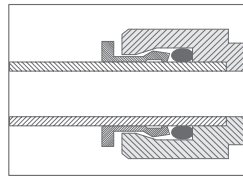

Press the tube into the end of collect part.

Disconnection

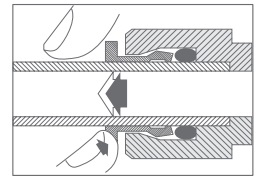

Press the collect by fingers and pull the tube to remove the tube from the collet.

## ● Filter Connection

1. Please insert the filter to the manifold and twist 90 degree to the right.
2. If the filter is not twisted anymore, the connection is completed.

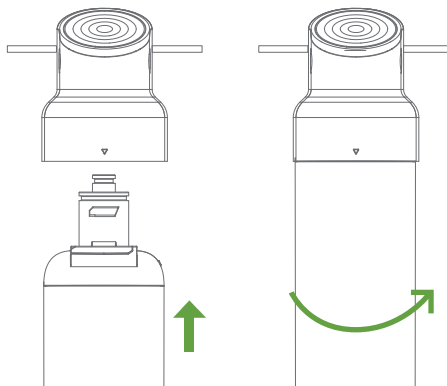

3. Please open the feed water valve.
4. Please flush a new filter for 10 min before use.

## Product Specification

**pureal**

Purification Type	10"	17"
Model No.	PPU-1000D (Drinking faucet type) PPU-1000K (Kitchen faucet type)	PPU-1700D (Drinking faucet type) PPU-1700K (Kitchen faucet type)
Filter Details	Composite Filter-Carbon Block, Ceramic ball	
Material Types	Carbon Block, PP, POM, EPDM, SILICON, STS	
Installation only for	Household and Indoor only	
Weight	2.5kg (Drinking faucet type) 2kg (Kitchen faucet type)	3kg (Drinking faucet type) 2.5kg (Kitchen faucet type)
Size (Manifold + filter)	95*97*326mm(W*D*H)	95*97*500mm(W*D*H)
Rated Service Flow	1.5 GPM	
Working Pressure	10~125 PSI (Minimum/Maximum)	
Operating Temp	40~100°F	
Replacement element	PPF-1000	PPF-1700
Rated capacity	10,000 gallon (12 months)	20,000 gallon (24 months)
Manufacture	PICOGRAM CO.,LTD. (118, Bupyeongbuk-ro, Bupyeong-gu, Incheon-si, Korea)	
Country of Origin	South Korea	

- System conforms to NSF/ANSI 42 for specific performance claims as verified and substantiated by test data.
- Do not use with water that is microbiologically unsafe or of unknown quality without adequate disinfection before or after the system.

## Troubleshooting

**pureal**

Symptom	Check-up	Solution
The bad taste of purified water.	<ul style="list-style-type: none"> <li>- Has the water purifier not been used for a period?</li> <li>- The filter has not been replaced in replacement period?</li> </ul>	<ul style="list-style-type: none"> <li>- Please flush the filter for 10 min.</li> <li>- Please replace a filter to new one.</li> </ul>
Water doesn't come out.	<ul style="list-style-type: none"> <li>- Is the tap water valve closed?</li> <li>- Is the filter and hose are connected to the manifold correctly?</li> <li>- The filter has not been replaced in replacement period?</li> </ul>	<ul style="list-style-type: none"> <li>- Please open the tap water valve.</li> <li>- Please make sure the hose is not folded.</li> <li>- Please check the filter and hose are connected to the manifold correctly.</li> <li>- Please replace a filter to new one and flush the filter for 10 min.</li> </ul>
Leakage from the water purifier	<ul style="list-style-type: none"> <li>- Is it humid in the indoor / house?</li> <li>- Is the leakage from the water purifier inside?</li> </ul>	<ul style="list-style-type: none"> <li>- There may have condensation on the surface of filter by temperature difference between inside and outside of filter at high humidity.</li> <li>- Please close the tap water valve after confirm leakage point and contact customer service.</li> </ul>

Picogram Co.,Ltd. states that this product will be free from material defects in materials and workmanship under normal use and service beginning on the date of purchase from us (we reserve the right to require proof of purchase), except as noted below, and continuing for the 1 year warranty coverage period.

And subject to the exclusions, as follows:

#### EXCLUSIONS FROM THIS LIMITED WARRANTY

This warranty does not cover the following instances:

- Warranty exclusions applicable to all Products and Parts:

1. Defects not reported to us within the applicable warranty period;
2. Membrane fouling or scaling
3. Any items manufactured by other companies, except if listed above. Such items may carry warranties offered by the original manufacturers
4. Problems resulting from failure to comply with installation, operation, or maintenance instructions or drawings, or improper installation, operation, or maintenance
5. Problems resulting from alteration, modification, or attempted repair of these Products or Parts by any party other than us or a party we have approved in writing
6. Damage or failure of products or parts due to friction, abrasion, chemical damage, or debris build-up on consumables
7. Products or Parts returned due to debris build-up, including, but not limited to, plugged filters
8. Noncompliance with applicable codes, and ordinances including without limitation, plumbing codes
9. Damage caused by accident, fire, flood, excessive heat or cold, Acts of God, misuse, misapplication, neglect, oxidizing agents (such as chlorine, ozone, chloramines, and other related oxidizers), corrosive liquids or gases or chemicals, failure to perform maintenance or cleaning, improper handling or storage, installation or operation contrary to our printed instructions in the applicable manual, or by the use of accessories or components that do not meet our specifications
10. Cost of installation and labor to install warrantied parts
11. Systems that have been installed or commissioned beyond the 1-year warranty coverage period

OUR WARRANTY OBLIGATIONS Should a material defect in workmanship or materials in Products or Parts covered by this warranty become evident during the applicable warranty period, then as our sole obligation and in full satisfaction of any warranty claim, we will replace the defective Product or Part (we will consider, in good faith, customer preference in determining whether to issue a credit or repair or replace). The terms of this warranty are subject to the laws and regulations of the country in which the Product or Part was purchased.

## PROCEDURE FOR OBTAINING WARRANTY REMEDIES

A. If you did not purchase the Product or Part directly from us, your claim should be initiated with the dealer from whom you purchased the Product or Part. If you are an authorized dealer or distributor and purchased the Product or Part directly from us, please contact your customer care representative to begin the warranty claim process.

B. We extend warranties solely to direct transactional customers of Picogram Co., Ltd. All secondary customers of these Products and Parts must submit warranty claims with their direct suppliers. C. In order to obtain the benefits of this Limited Warranty, defective Products or Parts must be returned to us as soon as possible after discovery of the material defect, but in no event later than the expiration date of the warranty period provided in this Limited Warranty. The subject Product or Part must be returned to the original point of shipment, freight prepaid, along with a letter stating the model number, serial number, if any, the date of purchase of the item which is claimed to be materially defective and a brief description of the problems encountered. We are not responsible under this Limited Warranty for any cost of shipping or transportation incurred in connection with the return of the Product or Part. Product returned in a manner that does not ensure integrity during shipment may not be covered by warranty.

NO OTHER WARRANTIES. TO THE EXTENT PERMITTED BY APPLICABLE LAW, PICOGRAM CO., LTD. DISCLAIMS ALL OTHER WARRANTIES, WHETHER EXPRESS OR IMPLIED, INCLUDING, BUT NOT LIMITED TO THE IMPLIED WARRANTIES OF MERCHANTABILITY AND FITNESS FOR A PARTICULAR PURPOSE, WITH REGARD TO THE PRODUCT(S), PART(S), AND ANY ACCOMPANYING WRITTEN MATERIALS. THIS LIMITED WARRANTY GIVES YOU SPECIFIC LEGAL RIGHTS. YOU MAY HAVE OTHERS THAT VARY FROM STATE TO STATE. NO LIABILITY FOR CONSEQUENTIAL DAMAGES.

As a manufacturer, we do not know the characteristics of your water supply or the purpose for which you are purchasing a Product or Part. The quality of water supplies may vary seasonally, geographically, or over a period of time, and your water usage rate may vary as well. For these reasons, we assume no liability for the determination of the proper equipment necessary to meet your requirements and we do not authorize others to assume such obligations for us.

No dealer, distributor or other person has any authority to make any warranties or representations concerning Picogram Co., Ltd. or its Products or Parts. Accordingly, Picogram Co., Ltd. is not responsible for any such warranties or representations.

### **Customer service :**

**Tel : (800)886-4961 Email : [service@pureal.co.kr](mailto:service@pureal.co.kr)**