

***N-Series* 3D Printer**

Quick Start Guide

* Please review this entire guide before operating the printer.

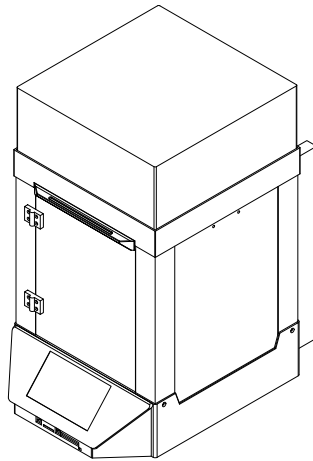

N1



www.raise3d.com

A Unpacking

Package Style: Wooden Case, Carton Case.

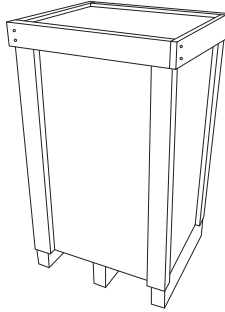

【Wooden Case】

Used for small quantity deliveries

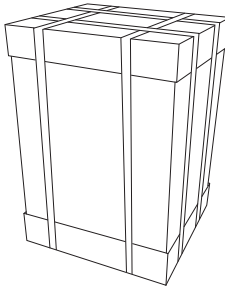

【Carton Case】

Used for large quantity deliveries

B List of Parts

N1

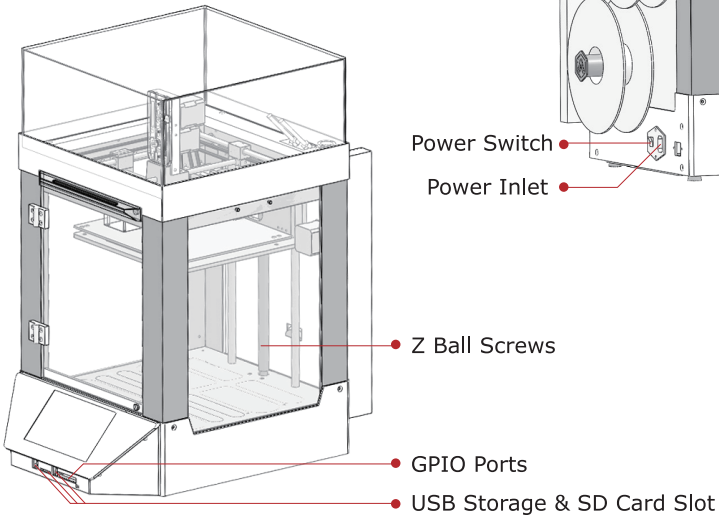
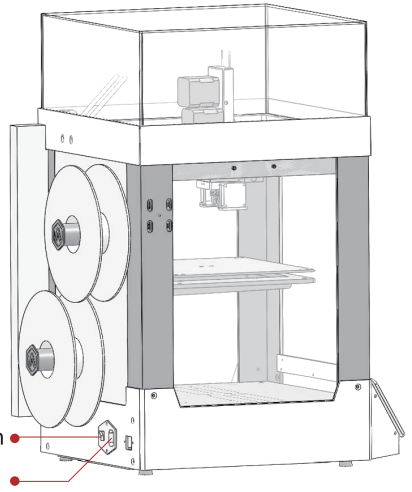
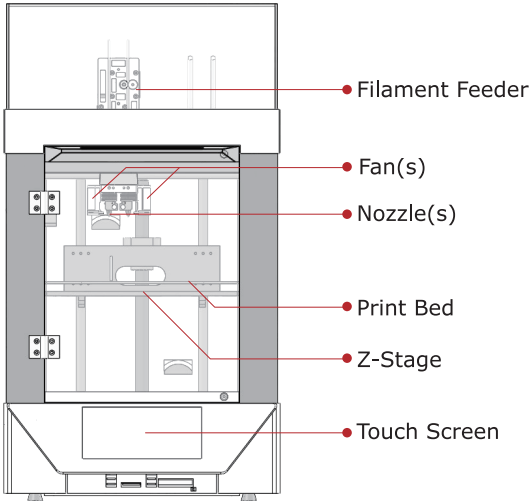

C Hardware Installation

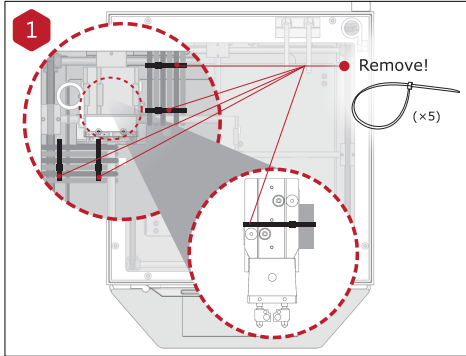

Cut the 5 zip ties that are securing the clips and the print head.

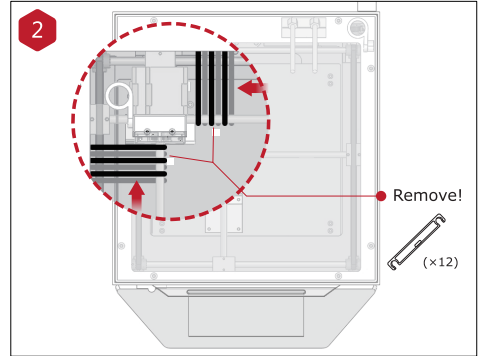

Please remove the 12 clips holding the extruder assembly in place before powering on your printer. If you fail to remove these clips your printer will be damaged. Please save these clips and re-install them if you transport your printer.

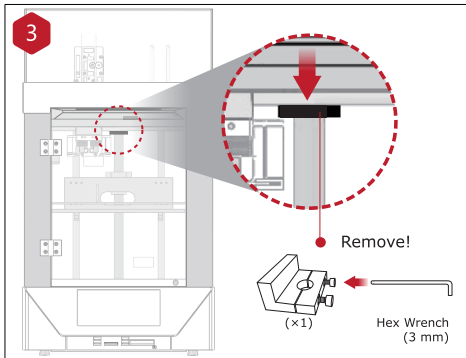

Unscrew the screw on the clamp holding the Z-axis in place. Use the 3mm Hex wrench which was shipped attached to the print platform.

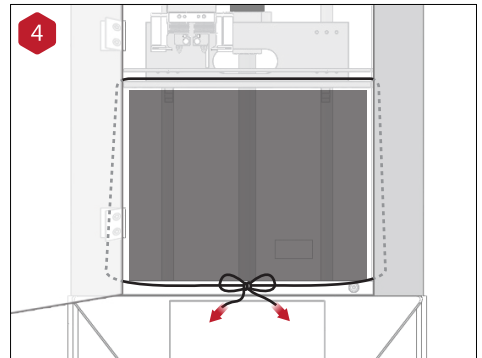

Untie the rope of the packaging material.

C Hardware Installation (continued)

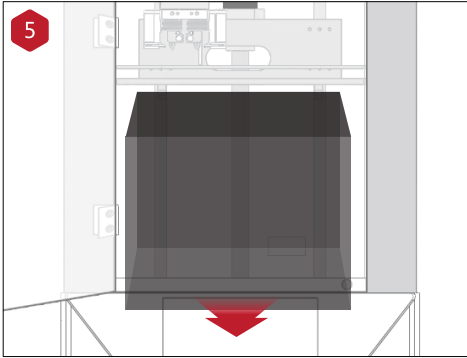

Lift the build plate gently with your hands and remove the packaging material under the build plate.

List of Contents

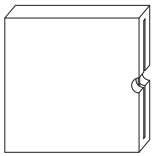

Glass with Protective Foam

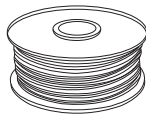

Filament (×1/×2)



Nozzle Cleaning Kit



Spade

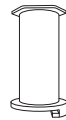

Filament Holder (×1/×2)

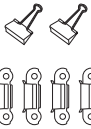

Build Plate Clips

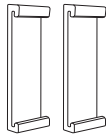

Fan Cover



Power Cable

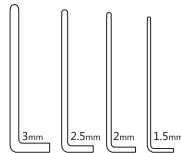

Hex Wrenches



Feeler Gage

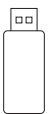

USB Storage



Fuse



Tweezers



Filament Guide Tube (×2/×4)

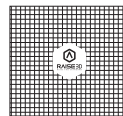

Build Surface



Others Accessories (Spare)

C Hardware Installation (continued)

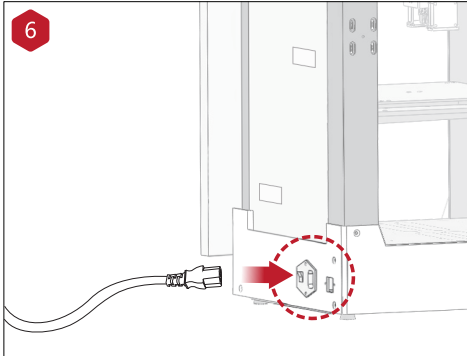

Plug in the power plug.

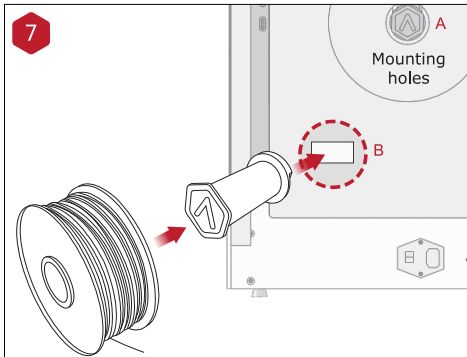

Install the filament holder in the mounting hole on the side of the printer and place a spool of filament on the holder.

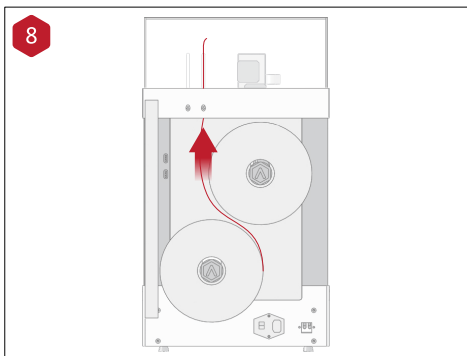

Feed the filament through the guide tube.

C Hardware Installation (continued)

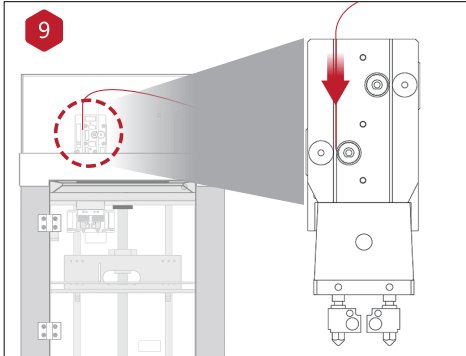

Push the top of the filament until it reaches the drive gear on the filament guide.

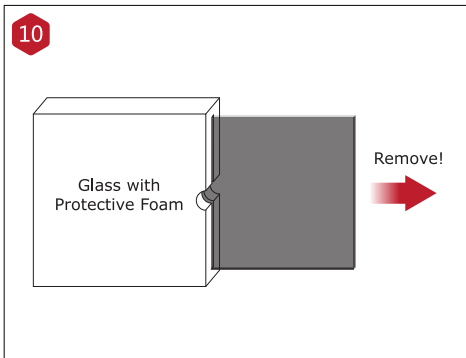

Remove the glass build plate from the protective foam.

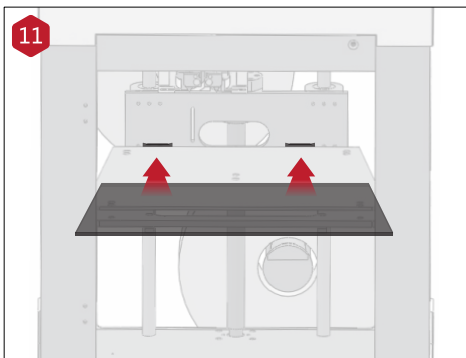

Gently slide the glass plate on the build plate. Make sure it snaps into the build plate clamps at the back.

C Hardware Installation (continued)

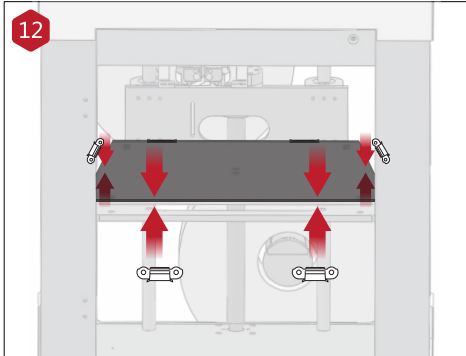

Please use the build plate clips to secure the glass build plate to the heated build plate.

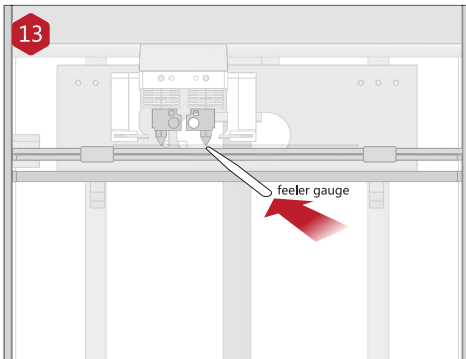

Please use feeler gauge to calibrate, make sure the feeler gauge suit to distance between nozzle and the heated build plate.

D Install ideaMaker

The ideaMaker software is available on the USB storage included with your printer.

Or go to www.raise3d.com and download the ideaMaker software.

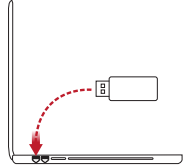

Windows Versions

- 1 Open the installer and choose the language. Set a path for installing ideaMaker then click "Next".

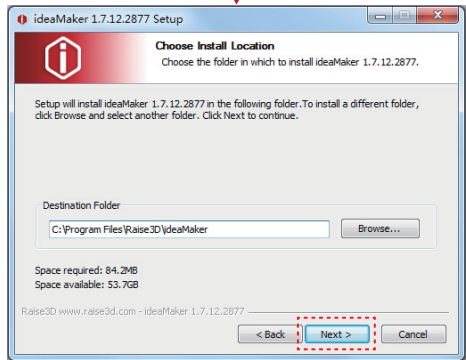
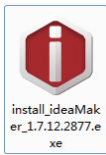

D Install ideaMaker (continued)

- 2 Follow the instructions and click "Install". After the installation has finished, click "Next" to move on the next step.

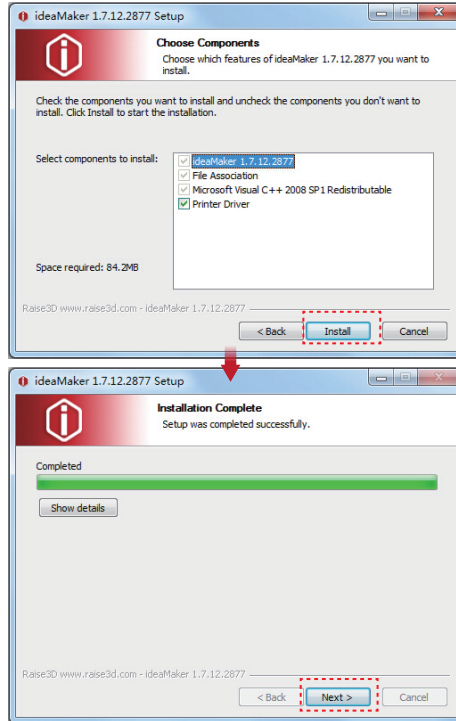

- 3 Click "Finish" and ideaMaker is installed.

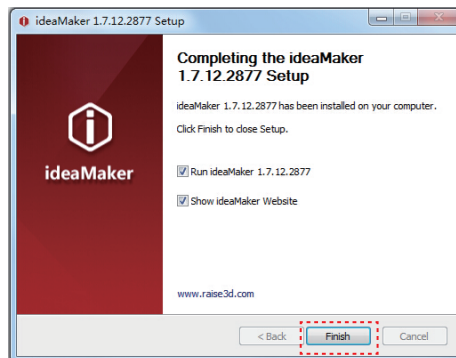

D Install ideaMaker (continued)



Mac Versions

Open the Disk Image for the ideaMaker installed on the USB storage included with your printer or that you downloaded from www.raise3d.com.



E ideaMaker initial settings

- 1 The first time you open ideaMaker you will need to select your printer model from the drop-down.

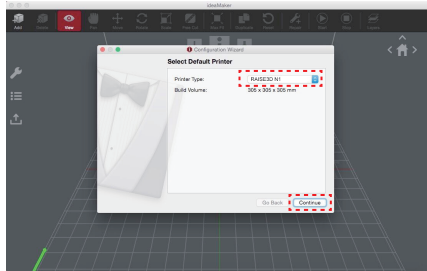

- 2 Select the number of nozzles. Press "Continue" to move on to the next step.

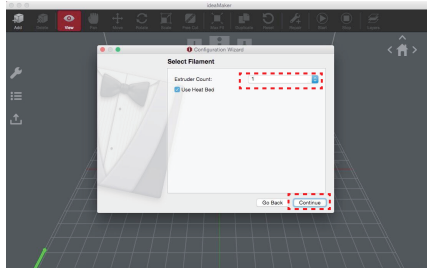

- 3 Select the diameter of the filament. Press "Done" to finish the initial settings.
NOTE: The N-Series all use 1.75mm filament.

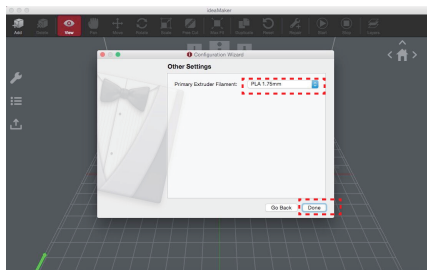

F Use ideaMaker

- 1 Click the "Add" button to import a .stl and .obj file. You can download a file or use the test model included in the USB storage.

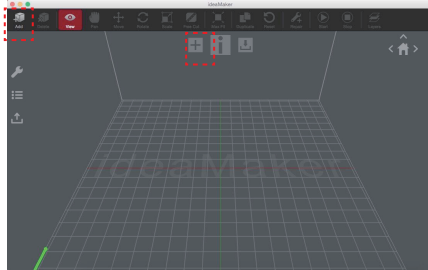

- 2 Click the "Slice" button to begin the slicing of the model.

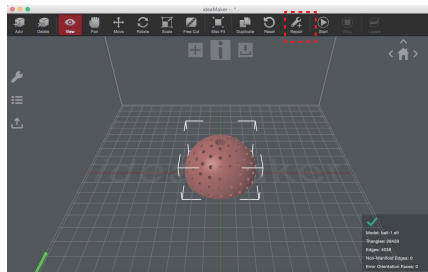

- 3 Select the slicing settings for your print. If you have the material that was shipped with your printer you will choose "PLA 1.75mm" on the Primary Extruder.

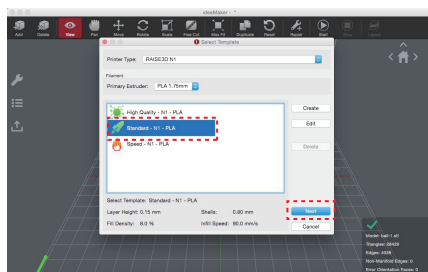

F Use ideaMaker (continued)

- 4 Choose the type of Raft support you would like and click "OK".

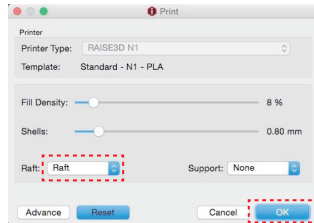

- 5 Save the sliced file to your USB storage.

NOTE: File names that do not conform to the Western Latin character set may not display properly.

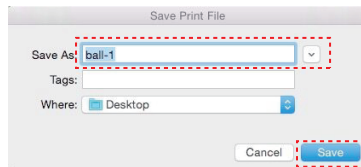

- 6 Save the sliced files (.gcode and .data) to USB Storage.



G Start first print

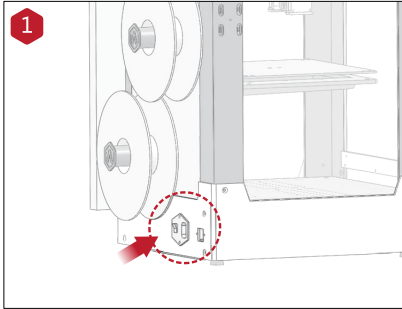

Turn the printer on with the power button on the back of the printer.



The printer will go through a start-up sequence. When the touch screen displays "Home", the printer is ready.

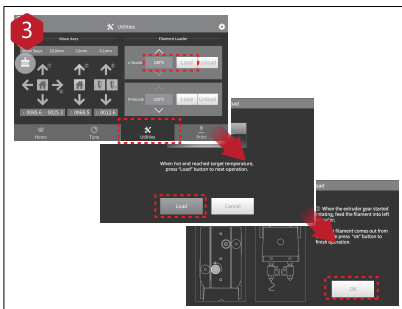

To load the filament, select "Utilities", choose the temperature of material you are printing and then press "Load". Follow the instructions on the screen to finish loading the filament.

G Start first print (continued)

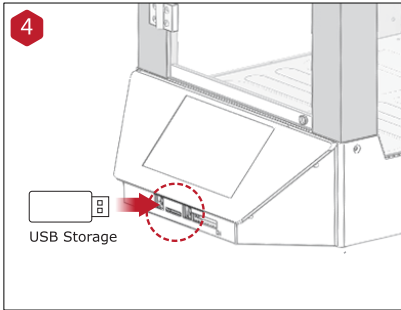

The USB storage included with the printer comes loaded with already sliced models. They are a good place to start for your first print. Insert the USB storage into the USB slot on the side of the touchscreen.

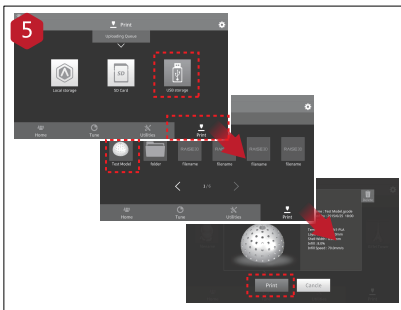

Select the "Print" menu, choose "USB Storage" in the file storage path, select the default test file, select the file to check the print parameters and settings, then press "Print" to start printing the test file.



During printing, you can check the print status, print time remaining and other parameters from the touchscreen under "Home" menu.

H User Interface

- Extruder and Heated Bed Temperature
- Current model name, total print time, current print status and height

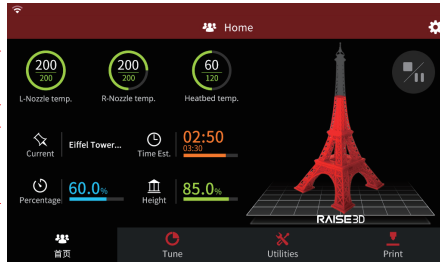

- Status bar
- Menu title, Settings Button
- Visual display of current model
- Pause/resume button
- Stop button
- Taskbar

Home

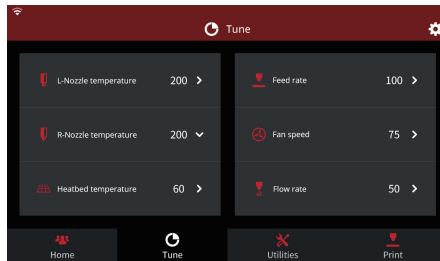

- Printing parameters and adjustment

Tune

- Moving step distance setting
- X/Y/Z axes move/return to original position

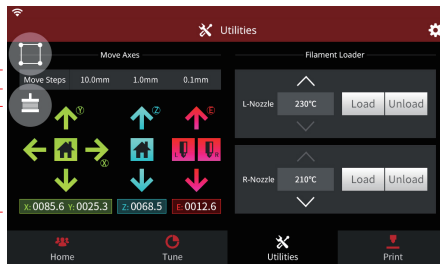

- Load and Unload function for the Left and Right Extruders.

Utilities

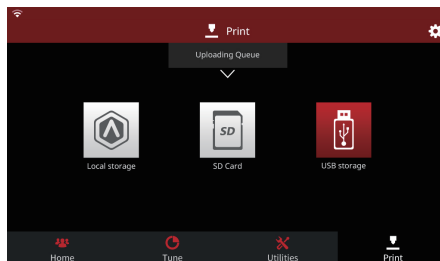

- Check file uploading queue
- Choose where you would like to load your print job from

Print

RAISE3D
www.raise3d.com

🏠 Floor 4, Building B5, No.1600, North Guoquan Rd, Shanghai, China 200433
☎ +86 21 65337855

🏠 2398 Walsh Ave, Santa Clara, CA, USA 95051
☎ +1 888 963 9028

🌐 www.raise3d.com
✉ support@raise3d.com