



USER MANUAL

INVISIBLE LEDS TRAIL CAMERA

Models:

IRON-9

IRON-10

C9

B10

G8

v1.0



THANK YOU FOR CHOOSING A SPYPOINT PRODUCT.

This manual will guide you through all the features of your device so that you will get optimal use out of your SPYPOINT product.

Our priority is to provide outstanding customer service. If you need support for your product, please contact the SPYPOINT technical support or visit our website.

CONTACT

 1-888-779-7646

 tech@spypoint.com

 www.spypoint.com

ABOUT US

 GG Telecom's mission is to offer products that are easy to use, innovative, affordable and of exceptional quality. Our SPYPOINT products are mainly used for hunting and residential/commercial surveillance. They are distributed and shipped all over the world and the market never stops growing. Prosperous and respected, GG Telecom is a company that constantly keeps abreast of new technologies and listens to its customers to deliver cutting-edge products with practical solutions that improve hunting and outdoor activities.

JOIN THE SPYPOINT COMMUNITY

 facebook.com/SPYPOINT

 twitter.com/SPYPOINTcamera

 youtube.com/SPYPOINTtrailcam



mySPYPOINT.com is an online camera & photo management system. This incredible tool for hunters is available for all SPYPOINT cameras.

NON-CELLULAR CAMERAS

Visit **mySPYPOINT.com** to create your free basic account.

CELLULAR CAMERAS

Visit **mySPYPOINT.com** to learn more about the different accounts available.

For the latest version of the activation procedure, go to **support.spypoint.com/activation**.

Package contents	4
Components	5
Power	7
Memory card	8
BUSY LED	8
Settings	9
Distance	11
Sound recording	13
File transfer to a computer	14
Troubleshooting	15
Error messages	15
Available accessories	16
Specifications	
IRON-9	18
IRON-10	19
C9	20
B10	21
G8	22
Regulation	23
Limited warranty	24
Repair service	24



SPYPOINT
camera



Installation
strap



USB
cable



Audio-video
cable



Quick start
guide

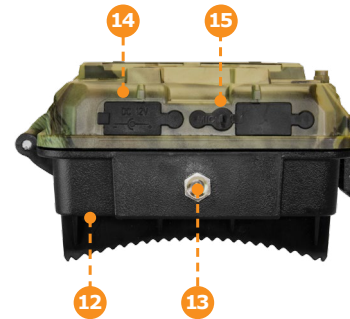
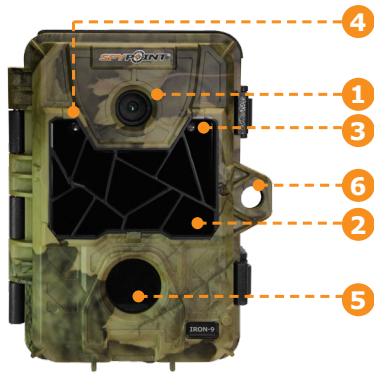

- 1 Photo lens
- 2 Invisibles LEDs
- 3 Test light
- 4 Light sensor
- 5 Fresnel lens
- 6 Cable lock hole

- 7 Configuration screen
- 8 BUSY LED
- 9 Switch panel
- 10 ON/OFF
- 11 Battery case

- 12 Slot for installation strap
- 13 Tripod mount
- 14 12V jack
- 15 Microphone

- 16 TV OUT
- 17 USB port
- 18 SD card slot
- 19 DISTANCE dial

1	Photo lens	Image sensor and infrared filter.
2	Invisible LEDs	Night lighting to obtain black and white photos and videos.
3	Test light	Flashes in TEST mode when there is detection and flashes 60 seconds in PHOTO/VIDEO mode to allow the user to leave without being photographed or recorded.
4	Light sensor	Allows the lighting of the LEDs panel at night.
5	Fresnel lens	Expands the detection area and increases the sensitivity of the camera's motion sensor.
6	Cable lock hole	Allows the user to install a CL-6FT cable lock, sold separately.
7	Configuration screen	To see battery level, date, number of recorded files, error messages and settings options.
8	BUSY LED	Lights up when TEST mode is activated.
9	Switch panel	Buttons to set the camera.
10	ON/OFF	Allows the user to turn on/off the camera.
11	Battery case	Case for AA batteries or a rechargeable lithium battery pack.
12	Slot for installation strap	Allows the user to install the camera using the installation strap included.

13	Tripod mount	Standard ¼-20" tripod mount.
14	12V power jack	This camera can be powered from an external 12-volt DC input such as a 12V battery or a 12V adapter, each sold separately.
15	Microphone	Records sound in video mode.
16	TV OUT	Allows the user to view or delete photos/videos directly on a TV.
17	USB port	To transfer photos/videos to a computer.
18	SD card slot	An SD card is required to record photos/videos.
19	DISTANCE dial	Allows the user to adjust the distance of detection and the sensitivity of the detector.

The battery level is shown on the LCD screen. When a single line remains, the camera will continue to take photos but we strongly recommend to change the AA batteries or charge the lithium battery pack before they are empty (see figure below). If a video is being recorded and the battery level reaches 0%, the camera saves the file before shutting down.

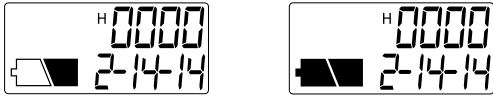

AA BATTERIES

This camera requires 6 AA batteries (1.5V). The use of alkaline or lithium batteries is strongly recommended. Insert the batteries as indicated inside the battery case. Battery polarity must be followed.



6 alkaline AA batteries



Please note that the voltage of rechargeable AA batteries (1.2V) is insufficient to power the SPYPOINT camera. We also recommend the use of new batteries to ensure maximum performance of the camera.

LITHIUM BATTERY PACK

This SPYPOINT camera can be powered by a rechargeable lithium battery pack LIT-09/LIT-C-8 (sold separately). This type of battery is less affected by cold temperatures and lasts up to 3 times longer than an alkaline batteries.



Lithium battery pack
LIT-09/LIT-C-8

EXTERNAL (12V)

This camera can also be powered by an external 12-volt DC input such as a 12-volt battery (KIT-12V, BATT-12V or KIT6V/12V) or a 12-volt adapter (AD-12V), sold separately. For the 12V available accessories, see p.16.

TIME BATTERY

The camera has a CR2032 lithium button battery which saves the time and date. To replace the battery:

1. Turn off the camera and remove it from the housing.
2. Using a flat screwdriver, push the tab to the right.



3. While pushing the tab, remove the compartment of the camera.



4. Replace the battery, the polarity must be respected (side + facing up).

MEMORY CARD

A memory card is required to record photos and videos. The camera is compatible with SD/SDHC memory cards, up to 32 GB capacity (sold separately).

When the camera is ON and no memory card is used, the screen displays "Card" meaning to insert one. When the SD card is full, the screen displays "FUL".

Here is a table of the approximate number of photos and length of videos that can be recorded with different memory card capacities. Many photo and video resolutions are noted, see those corresponding to the camera.

Note: This SPYPOINT camera is equipped with continuous file recording. When the memory card is full, the camera will continue to record photos or videos by deleting the first recorded files.

	4 GB	8 GB	16 GB	32GB
Photo				
3 MP	4100	8200	16400	32800
4 MP	3800	7600	15200	30400
5 MP	3400	6800	13600	27300
6 MP	3200	6300	12600	25300
7 MP	2700	5500	10900	21800
8 MP	2400	4800	9500	19000
9 MP	2200	4500	8900	18000
10 MP	1900	3800	7600	15200
11 MP	1700	3400	6700	13400
12 MP	1600	3200	6300	12600
Video				
320 x 240	4 h	8 h	16 h	32 h
640 x 480	2h10	4h10	8h20	16h40
1280 x 720	40 min	1h20	2h40	5h20

INSERTING THE MEMORY CARD



Insert an SD/SDHC memory card (up to 32 GB capacity) in the card slot. The card is inserted correctly when a click is heard.

 Before inserting or removing a memory card, always turn off the camera to prevent loss or damage of the photos already recorded.

REMOVING THE MEMORY CARD

Lightly press the memory card into the camera once to pop it out of the slot and remove it.

"BUSY" DEL

The "BUSY" light, located below the screen, It is a diagnostic tool. It lights up when the camera starts, when the camera records a file and in TEST mode at the same time as the test light (located in front of the camera).

Settings

IRON

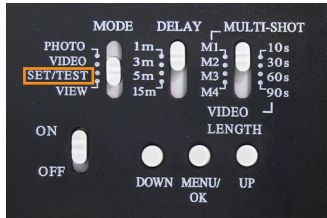

To configure the general settings, set the camera to **SET/TEST** mode. Press **OK** to enter the menu. The flashing option is the one that can be modified using **UP/ DOWN**. Press **OK** to confirm and to set the next option. Once you went through all the options, turn the camera **OFF** to record the settings.

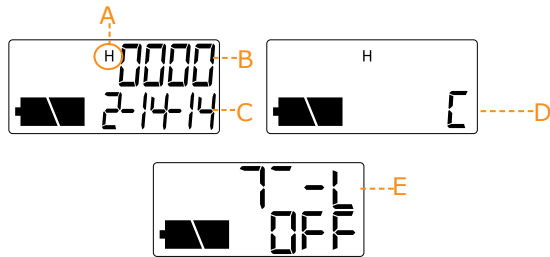

- A: Set the **Photo quality** (High/Low) * see table on next page
- B: Number of recorded files display
- C: Set the **Date/Time** (MM/DD/YY, hh:mm)
- D: Set the **Temperature** (Celcius/Farenheit)
- E: Set the option **Time-lapse** (On/Off) *IRON-10 only

* This table shows the photo and video resolution depending on the photo quality setting (High/Low).

	IRON-9 (Non-HD videos)	IRON-10 (HD Videos)
Video		
Low	320 x 240	640 x 480
High	640 x 480	1280 x 720
Photo		
Low	3 mp	
High	9 mp	10 mp

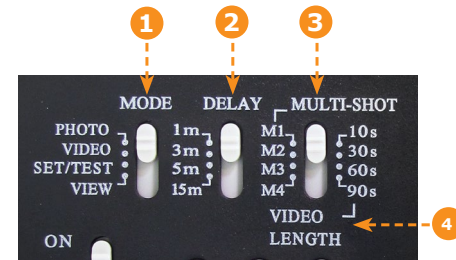

1 MODE PHOTO

Allows the user to take photos. When the PHOTO mode is selected, the test light in front of the camera will flash for 60 seconds to allow the user to leave the area without being photographed.

VIDEO

Allows the user to take videos. When the VIDEO mode is selected, the test light in front of the camera (see above) will flash for 60 seconds to allow the user to leave the area without being recorded.

SET-TEST

Allows the user to test the detection system of the camera. When the SET/TEST mode is selected, no photo or video is recorded. Pass in front of the camera from left to right. When the camera detects a motion, the test light blinks to indicate that the camera would normally have saved a photo or video. If the system does not detect the movement, increase the detection distance using the DISTANCE wheel or realign the system differently.

INSTALLATION WITH THE SUPPLIED STRAP

The dimensions of the strap (included) is 1" X 60".

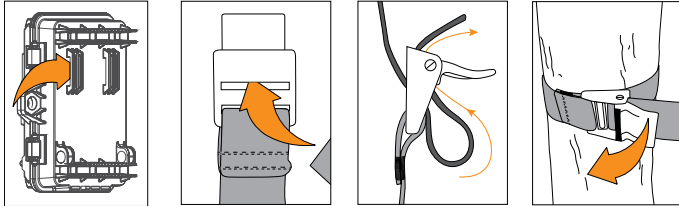

Recommended installation height: about 3 feet above the ground.

 Do not place the camera facing the sun.

VIEW

Allows the user to view or delete recorded photos and videos directly on a television.

1. Turn OFF the camera.
2. Set the switch MODE to VIEW.
3. Connect the yellow end of the audio-video cable (supplied) into the VIDEO IN of the TV and the other end into the TV OUT of the camera.



4. Turn ON the camera and the last recorded photo or video will appear. To change the photo or the video, use the UP or DOWN button.

Here are the options available by pressing MENU/OK:

View Date/Time:	Allows the user to view the date and time printed on the photo.
Protect:	Allows the user to protect a photo or video to prevent it from being deleted by selecting "Erase All".
Erase one:	Allows the user to erase the photo or the video seen on the screen from the memory card.
Erase all:	Allows the user to erase all stored photos and videos, with the exception of protected photos and videos from the memory card.
Format:	Allows the user to erase the entire contents of the memory card, including the protected files.
Language:	Allows the user to change the display language.
Exit:	Allows the user to exit the menu to return to the viewing screen.

Here are the different moon phases that are printed on photos.
(IRON-10 / C9)

- New moon:
- Waxing Crescent:
- First Quarter:
- Waxing Gibbous:
- Full moon:
- Waning Gibbous:
- Last Quarter:
- Waning crescent:



2 DELAY (IN PHOTO MODE)

Allows the user to choose the time interval between each detection before the camera records the next photo or video*.

Additional setting: It is possible to decrease the delay between detections to 10 seconds (instead of 1 minute) by using the following procedure. Note that the battery life will be affected.

1. Turn OFF the camera.
2. Press and hold the UP button, turn the camera on. "10_S" appears on the screen meaning the 1 minute delay has been replaced by a 10 second delay.
3. To reset the camera to 1 minute delay, follow the same procedure. "1_M" appears on the screen (see figure below).



10 s delay



1 min delay

DELAY (WITH TIME LAPSE ON)

Allows the camera to take photos at regular preset intervals without detection (**IRON-10**). The user can obtain photos of game outside the detection range of the camera.

To set the Time-lapse option:

1. Turn the Time-Lapse option ON in the settings menu of the camera.

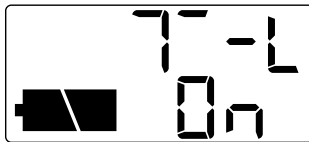

2. Set the switch panel in PHOTO mode, and choose the intervals with the DELAY switch.
3. To go back to regular photo settings, turn OFF the Time Lapse option.

Note: The TIME LAPSE mode only applies for photos, not videos.

3 MULTI-SHOT

Takes up to 4 consecutive shots at each detection, with a 10 second delay between each photo. For the cameras with a Flash unit, the delay between each photo will be 15 seconds. This option allows the user to get up 4 photos from different angles when the camera is in PHOTO mode.

4 VIDEO LENGTH

Allows the user to select the duration of the recording when the camera is set in VIDEO mode.

DISTANCE

Turn the DISTANCE dial to the right to increase the detection distance and the sensitivity of the detector.



The camera is equipped with a detector sensitive to infrared. The system will only detect a heat source in motion. The greater the mass of heat, the more sensitive the system is. The range of detection is between 5 and 65 feet. The best way to adjust the distance is to set the camera to SET/TEST mode. Make sure to have the least amount of objects possible in front of the camera during positioning. This will prevent photos being taken by the camera when oriented towards the sun at the same time an object moves in front of the camera (e.g. a branch).

Settings

IRON

Here is a table of approximate detection distances and width of the detection area according to the DISTANCE dial setting. The data can be affected by the size of the subject and the outside temperature. **Note that this data is for illustrative purposes only.**

Value on dial	Sensitivity	Detection distance (ft)	Width of the detection area (ft)	
MIN.	↓ Gradually increases ↓	5-30	3	
2		30-50	15	
4			50-65	30
6				30
8		30		
MAX.				

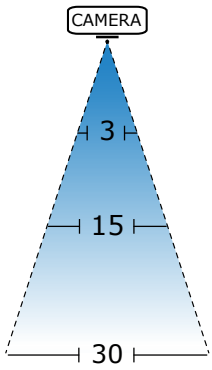

Sound recording

IRON

The SPYPOINT camera offers the possibility to record sound in VIDEO mode. When the VIDEO mode is selected, the camera automatically records the sound. Under the camera, you will find a rubber cap with the inscription MIC. If the user does not want to record the sound, the rubber cap needs to stay in place. If sound recording is required, the user must lift the rubber cap and turn it slightly so that the microphone receiver is completely cleared (See figure below).

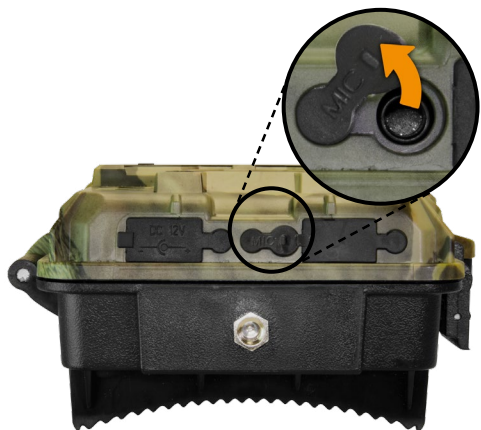

To transfer photos/videos to a computer:

1. Turn OFF the camera.
2. Connect the USB cable (supplied) from the camera to a computer.



3. The computer will detect the camera and install the driver automatically.
4. Click on "My Computer" and select "Removable Disk".
5. Then click on "DCIM" and "100DSCIM" to find all recorded photos and videos.
6. Drag or save the files to the desired location.

Taking the memory card out (sold separately) of the camera and inserting it into the computer slot will achieve the same results.

TROUBLESHOOTING

Problem	Possible solutions
Impossible to turn on the camera	<ul style="list-style-type: none"> • Verify if there are batteries in the camera. • Verify if the batteries are correctly installed. • Verify if the battery switch position is positioned according to the power source. • Install the latest update (available on www.spypoint.com under SUPPORT section). • Replace alkaline batteries or recharge the lithium battery pack.
The screen of the camera turns off	<ul style="list-style-type: none"> • The camera may be set to PHOTO or VIDEO mode and the screen turns off after a period of 60 seconds in order to preserve battery life. • To return to the screen, turn off the camera and turn it on again.
The camera does not respond	<ul style="list-style-type: none"> • Remove the batteries and reinstall them. • Replace alkaline batteries or recharge the lithium battery pack.
The camera works, but is losing its time and date settings	<ul style="list-style-type: none"> • The time battery must be replaced.
Impossible to take photos/videos	<ul style="list-style-type: none"> • Verify if there are batteries in the camera. • Replace alkaline batteries or recharge the lithium battery pack. • Memory card is full. • Verify if the camera is turned on.
No person/animal on photos	<ul style="list-style-type: none"> • Sunrise or sunset can trigger the sensor. Camera must be re-orientated. • At night, the motion detector may detect beyond the range of the IR illumination. Reduce distance setting. • Small animals may trigger the unit. Reduce distance setting and/or raise height of camera. • Motion detector may detect animals through foliage. • If a person or animal moves quickly, it may move out of the camera's field of view before the photo is taken. Move the camera further back or redirect the camera. • Make sure the mounting post or tree is stable and does not move.

Red light in front of the camera blinks	<ul style="list-style-type: none"> • MODE switch is in SET/TEST. • MODE switch is in PHOTO or VIDEO. The red light in front of the camera flashes for 60 seconds to allow the user to leave without being photographed or recorded.
The photos/videos do not appear on the television	<ul style="list-style-type: none"> • Verify if the camera is correctly connected to the television using the RCA cable. • Verify if the memory card contains photos/videos.
The computer does not recognize the camera	<ul style="list-style-type: none"> • Verify if the camera is properly connected to the computer using the USB cable.
The computer can't play videos	<ul style="list-style-type: none"> • The .MP4 video format requires the use of a video player software compatible such as VLC, Windows Media Player or QuickTime.

ERROR MESSAGES

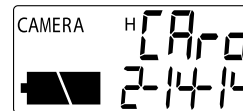

There is no memory card in the camera, insert a card.

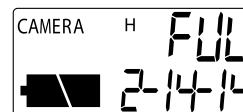

The memory card is full, delete the files or use a new memory card.

Available accessories

IRON

To obtain more information on the available accessories, go to www.spypoint.com. Here are the main accessories available:

POWER



12V DC Power cable
#CB-12FT, 12 ft power cable with alligator clips at one end to connect a 12V battery to a camera.



Lithium battery pack & charger
#LIT-C-8, Rechargeable lithium battery pack and AC charger with charge indicator light. Fits all SPYPOINT cameras.



12-volt Adaptor
#AD-12V, AC adaptor (6V to 12V). Powers the camera from an electrical outlet.



Universal power kit
#KIT6V-12V, Universal kit with 6 volts or 12 volts output. Compatible with all SPYPOINT products or any other products equipped with a 6 volts or 12 volts power jack. 6 connectors included to fit any device. Includes 6 volts (5.6Ah) and 12 volts (2.8Ah) output configuration and AC charger.



Lithium battery pack
#LIT-09, Additional rechargeable lithium battery pack. Fits all SPYPOINT cameras.



Rechargeable 12V battery, charger & housing kit
#KIT-12V, 12-volt 7.0Ah rechargeable battery with a water resistant ABS plastic case, AC charger, 12 ft power cable (#PW-12FT) and carrying strap included. Compatible with all SPYPOINT products equipped with a 12V power jack.



Spare power cable
#PW-12FT, Spare 12 ft power cable, to connect the camera to the KIT-12V.



Rechargeable 12V battery & charger set
#BATT-12V, 12-volt 7.0Ah rechargeable battery and AC charger to power the camera.

MEMORY CARD



SD Memory card 8GB
#SD-8GB, SDHC memory card 8 GB, High speed Class 6.



SD Memory card 16GB
#SD-16GB, SDHC UHS-1 memory card 16 GB, ultra high speed Class 10.

INSTALLATION AND SECURITY



Cable lock

#CL-6FT, 6 ft cable lock fits all SPYPOINT cameras.



Steel security box

#SB-91, Steel box to secure the camera against theft. It also protects it from breakage caused by bears or other animals. Fits all 35 and 46 LED SPYPOINT cameras. Also available in black.



Camera mount

#MA-360, Adjustable mounting arm, fits all cameras that have a standard 1/4-20" tripod mount. It can rotate 360° and tilt approx +/- 90°. Also available in black.



Tripod

#TP-CAM, SPYPOINT Lightweight tripod, in black aluminum, with a unique anchor system and a removable quick release plate. Max. height: 4.9 ft (1.5 m), min. height: 1.7 ft (0.5 m), max. load weight: 11 lbs (5 kg). Fits most SPYPOINT products.

Specifications (IRON-9)

Photo recording

Photo resolution	3 MP, 9 MP
File format	JPG
Multi-shot mode	Up to 4 photos per detection
Stamp (only on photos)	Date, time, and temperature (°C/°F)
Capture mode	Color by day, black and white by night

Video recording

Video resolution	320 x 240 or 640 x 480
File format	AVI
Sequence length	Adjustable from 10 to 90 s
Capture mode	Color by day, black and white by night

Audio

Sound recording (automatically recorded in video mode)	Mono
---	------

Memory storage

Support	<ul style="list-style-type: none"> •Internal memory: none •External memory : SD/SDHC card (up to 32 GB)
---------	---

Viewing

TV output	Composite video (PAL/NTSC)
Computer output	USB 2,0

Power source

Accessories sold separately, p.16

Alkaline or lithium batteries	6 x AA
Lithium battery pack	Rechargeable battery pack (LIT-09/LIT-C-8)
External (12V jack)	12V battery (KIT6V-12V, KIT-12V, BATT-12V) or 12V adapter (AD-12V)

Detection system

Motion sensor	PIR
Detection angle	30°
Detection range	Adjustable from 5 to 65 ft
Delay between each detection	Adjustable from 1 to 15 min *Additional 10 s setting

Night time illumination system

LEDs	35 LEDs
Type	Invisible LEDs
Exposure	Automatic infrared level adjustment

Optical field of view

40°

Dimensions

5.1" W X 6.9" H X 2.6" D

Recommendations

Operating temperature	(-30 °C to + 50 °C) (-22 °F to +122 °F)
Storage temperature	(-40 °C to + 60 °C) (-40 °F to +140 °F)

Specifications (IRON-10)

Photo recording

Photo resolution	3 MP, 10 MP
File format	JPG
Time lapse mode	Predefined intervals from 1 min to 15 min
Multi-shot mode	Up to 4 photos per detection
Stamp (only on photos)	Date, time, temperature (°C/°F) and moon phase
Capture mode	Color by day, black and white by night

Video recording

Video resolution	640 x 480 or 1280 x 720
File format	AVI
Sequence length	Adjustable from 10 to 90 s
Capture mode	Color by day, black and white by night

Audio

Sound recording (automatically recorded in video mode)	Mono
--	------

Memory storage

Support	<ul style="list-style-type: none"> •Internal memory: none •External memory : SD/SDHC card (up to 32 GB)
---------	---

Viewing

TV output	Composite video (PAL/NTSC)
Computer output	USB 2,0

Power source

Accessories sold separately, p.16	
Alkaline or lithium batteries	6 x AA
Lithium battery pack	Rechargeable battery pack (LIT-09/LIT-C-8)
External (12V jack)	12V battery (KIT6V-12V, KIT-12V, BATT-12V) or 12V adapter (AD-12V)

Detection system

Motion sensor	PIR
Detection angle	30°
Detection range	Adjustable from 5 to 65 ft
Delay between each detection	Adjustable from 1 to 15 min *Additional 10 s setting

Night time illumination system

LEDs	35 LEDs
Type	Invisible LEDs
Exposure	Automatic infrared level adjustment

Optical field of view

40°

Dimensions

5.1" W X 6.9" H X 2.6" D

Recommendations

Operating temperature	(-30 °C to + 50 °C) (-22 °F to +122 °F)
Storage temperature	(-40 °C to + 60 °C) (-40 °F to +140 °F)

Specifications (C9)

Photo recording	
Photo resolution	3 MP, 9 MP
File format	JPG
Multi-shot mode	Up to 4 photos per detection
Stamp (only on photos)	Date, time, temperature (°C/°F) and moon phase
Capture mode	Color by day, black and white by night
Video recording	
Video resolution	640 x 480 or 1280 x 720
File format	AVI
Sequence length	Adjustable from 10 to 90 s
Capture mode	Color by day, black and white by night
Audio	
Sound recording (automatically recorded in video mode)	Mono
Memory storage	
Support	<ul style="list-style-type: none"> •Internal memory: none •External memory : SD/SDHC card (up to 32 GB)
Viewing	
TV output	Composite video (PAL/NTSC)
Computer output	USB 2,0
Power source	
Accessories sold separately, p.16	
Alkaline or lithium batteries	6 x AA
Lithium battery pack	Rechargeable battery pack (LIT-09/LIT-C-8)
External (12V jack)	12V battery (KIT6V-12V, KIT-12V, BATT-12V) or 12V adapter (AD-12V)

Detection system	
Motion sensor	PIR
Detection angle	30°
Detection range	Adjustable from 5 to 65 ft
Delay between each detection	Adjustable from 1 to 15 min *Additional 10 s setting
Night time illumination system	
LEDs	46 LEDs
Type	Invisible LEDs
Exposure	Automatic infrared level adjustment
Optical field of view	
40°	
Dimensions	
5.1" W X 6.9" H X 2.6" D	
Recommendations	
Operating temperature	(-30 °C to + 50 °C) (-22 °F to +122 °F)
Storage temperature	(-40 °C to + 60 °C) (-40 °F to +140 °F)

Specifications (B10)

Photo recording

Photo resolution	3 MP, 10 MP
File format	JPG
Multi-shot mode	Up to 4 photos per detection
Stamp (only on photos)	Date, time and temperature (°C/°F)
Capture mode	Color by day, black and white by night

Video recording

Video resolution	640 x 480 or 1280 x 720
File format	AVI
Sequence length	Adjustable from 10 to 90 s
Capture mode	Color by day, black and white by night

Audio

Sound recording (automatically recorded in video mode)	Mono
---	------

Memory storage

Support	<ul style="list-style-type: none"> •Internal memory: none •External memory : SD/SDHC card (up to 32 GB)
---------	---

Viewing

TV output	Composite video (PAL/NTSC)
Computer output	USB 2,0

Power source

Accessories sold separately, p.16

Alkaline or lithium batteries	6 x AA
Lithium battery pack	Rechargeable battery pack (LIT-09/LIT-C-8)
External (12V jack)	12V battery (KIT6V-12V, KIT-12V, BATT-12V) or 12V adapter (AD-12V)

Detection system

Motion sensor	PIR
Detection angle	30°
Detection range	Adjustable from 5 to 65 ft
Delay between each detection	Adjustable from 1 to 15 min *Additional 10 s setting

Night time illumination system

LEDs	46 LEDs
Type	Invisible LEDs
Exposure	Automatic infrared level adjustment

Optical field of view

40°

Dimensions

5.1" W X 6.9" H X 2.6" D

Recommendations

Operating temperature	(-30 °C to + 50 °C) (-22 °F to +122 °F)
Storage temperature	(-40 °C to + 60 °C) (-40 °F to +140 °F)

Specifications (G8)

Photo recording

Photo resolution	3 MP, 8 MP
File format	JPG
Multi-shot mode	Up to 4 photos per detection
Stamp (only on photos)	Date, time and temperature (°C/°F)
Capture mode	Color by day, black and white by night

Video recording

Video resolution	640 x 480 or 1280 x 720
File format	AVI
Sequence length	Adjustable from 10 to 90 s
Capture mode	Color by day, black and white by night

Audio

Sound recording (automatically recorded in video mode)	Mono
---	------

Memory storage

Support	<ul style="list-style-type: none"> •Internal memory: none •External memory : SD/SDHC card (up to 32 GB)
---------	---

Viewing

TV output	Composite video (PAL/NTSC)
Computer output	USB 2,0

Power source

Accessories sold separately, p.16

Alkaline or lithium batteries	6 x AA
Lithium battery pack	Rechargeable battery pack (LIT-09/LIT-C-8)
External (12V jack)	12V battery (KIT6V-12V, KIT-12V, BATT-12V) or 12V adapter (AD-12V)

Detection system

Motion sensor	PIR
Detection angle	30°
Detection range	Adjustable from 5 to 65 ft
Delay between each detection	Adjustable from 1 to 15 min *Additional 10 s setting

Night time illumination system

LEDs	35 LEDs
Type	Invisible LEDs
Exposure	Automatic infrared level adjustment

Optical field of view

40°

Dimensions

5.1" W X 6.9" H X 2.6" D

Recommendations

Operating temperature	(-30 °C to + 50 °C) (-22 °F to +122 °F)
Storage temperature	(-40 °C to + 60 °C) (-40 °F to +140 °F)

Regulation

FCC REGULATIONS

FCC Part 15

FC This equipment has been tested and found to comply with the limits for a Class B digital device, pursuant to Part 15 of the Federal Communications Commission (FCC) rules. These limits are designed to provide reasonable protection against harmful interference in a residential installation. This equipment generates, uses and can radiate radio frequency energy and, if not installed and used in accordance with the instructions, may cause harmful interference to radio communications. However, there is no guarantee that interference will not occur in a particular installation. If this equipment does cause harmful interference to radio or television reception, which can be determined by turning the equipment off and on, the user is encouraged to try to correct the interference by one or more of the following measures:

- Reorient or relocate the receiving antenna.
- Increase the separation between the equipment and receiver.
- Connect the equipment into an outlet on a circuit different from that to which the receiver is connected.
- Consult the dealer or an experienced radio/TV technician for help.

Changes or modifications to this equipment not expressly approved by the party responsible for compliance could void the user's authority to operate the equipment. This device complies with Part 15 of the FCC rules. Operation is subject to the following two conditions: (1) this device may not cause harmful interference, and (2) this device must accept any interference received, including interference that may cause undesired operation.

CE Hereby, GG Telecom declares that this camera is in compliance with the essential requirements and other relevant provisions of Directive 2004/108/EC. The user can obtain a copy of the Declaration of Conformity by e-mail at info@spypoint.com.



Limited warranty and repair

This SPYPOINT product designed by GG Telecom, is covered by a one (1) year warranty on material and workmanship starting from the original date of purchase. The sales receipt is the client's proof of purchase and must be presented if warranty service is needed. This warranty will be honored in the country of purchase only.

This GG Telecom warranty does not apply: (a) to consumable parts, including but not limited to batteries, which performance is designed to decrease over the course of time; (b) to damage caused by misuse, use with another product, neglect, accidents, liquid contact, fire, earthquake or any other external cause; (c) to GG Telecom products that have been purchased online from an unauthorized dealer; (d) to products that have had any modification or tampering; (e) to cosmetic damage including but not limited to scratches and broken plastic; (f) to damage caused by operating the GG Telecom product outside of GG Telecom's recommendations.

INSTRUCTIONS FOR REPAIR SERVICE

GG Telecom will repair the product without charge or replace it at its discretion with an equivalent product, if it has a manufacturing defect covered by the warranty described previously. GG Telecom will pay the shipping costs only for the return of the products covered by the warranty. The shipping costs for an item sent will be assumed by the customer.

Repairs for damages not covered by the warranty will be subject to a reasonable charge. The customer will pay all shipping costs.

- 1. BEFORE** sending a product for repair, the customer is welcomed to contact GG Telecom technical support team at 1-888-779-7646 or tech@spypoint.com and to clearly describe the problem and give a phone number where she or he can be reached. It happens regularly that some problems can be solved over the phone.
- 2.** If a product needs to be sent, an RMA number will be given to the customer (Return Merchandise Authorization).
- 3.** The original receipt or a copy must be sent along with the package.
- 4.** The RMA number must be written on the outside of the package and sent to:

CANADA
GG Telecom
120 J.Aurèle-Roux
Victoriaville, QC
G6T 0N5

United States
GG Telecom
555 VT route 78
Swanton, Vermont
05488

IMPORTANT: Under no circumstances will GG Telecom accept returned products without a Return Material Authorization number (RMA). It is essential to contact GG Telecom before making a return.

The customer is liable for loss or damage to the product that may occur during the transport to GG Telecom. We recommend the use of a traceable method of shipping to ensure protection.

WWW.SPYPOINT.COM