



LINK-S



USER MANUAL

CELLULAR TRAIL CAMERA

Models:

LINK-S

LINK-S-V

 support.spypoint.com

 1-888-779-7646

 support@spypoint.com

v1.0





THANK YOU FOR CHOOSING A SPYPOINT PRODUCT.

This manual will guide you through all the features of your device so that you will get optimal use out of your SPYPOINT product. We strive on offering all customers a positive, user friendly experience that will have a lasting impression.

JOIN THE SPYPOINT COMMUNITY

 facebook.com/SPYPOINT

 twitter.com/SPYPOINTcamera

 youtube.com/SPYPOINTtrailcam



ABOUT US

Our passion and commitment to the hunting industry has highly contributed to our success story. We are very proud of the path our home grown company has taken and very grateful for every opportunity we have had. Quality, personalized service and support were the foundation for us and we continue to pursue this rule of thumb as our business grows.

Team work is the most important word for us at SPYPOINT and is the key to our innovations and constant progress. A company is only as successful as its communication and team efforts. We are forever thankful to the team that supports us on a daily basis but furthermore we are honored to have such talented and committed individuals to call our SPYPOINT family.

Components	4
Specifications	
LINK-S & LINK-S-V	6
Power	7
Memory card & Busy LED	8
Settings	9
SPYPOINT LINK App	13
Installation & Mounting bracket	14
File transfer to a computer	15
Available accessories	16
Troubleshooting	17
Warranty & Repair	19
Regulation	20

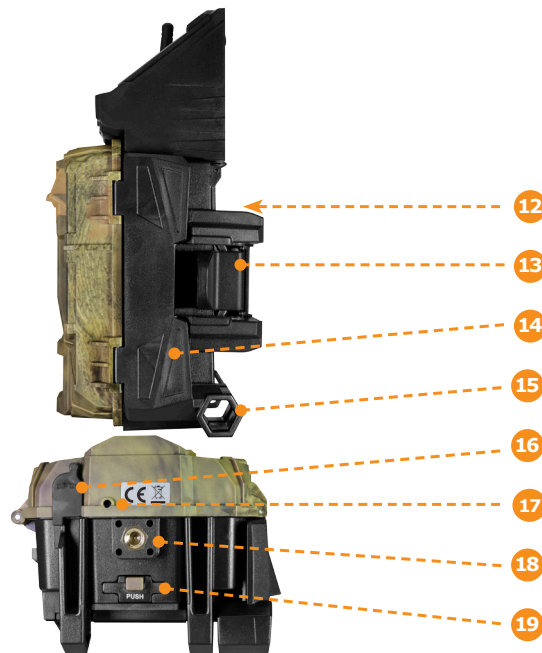

- 1 Antenna
- 2 Solar pannel
- 3 LEDs
- 4 Photo lens
- 5 Light sensor
- 6 Viewing screen
- 7 Detection lens
- 8 Test light
- 9 Navigation buttons
- 10 ON / OFF Switch
- 11 SD card slot
- 12 Battery case & Micro SIM card slot
- 13 Slot for installation strap
- 14 Locking latch
- 15 Cable lock hole
- 16 12V jack
- 17 Microphone
- 18 Tripod mount
- 19 Battery door push button

Components

1	Antenna	Allows cellular wireless communication.
2	Solar Panel	Allows to charge the internal battery.
3	LEDs	Night lighting to obtain black and white photos and videos.
4	Photo lens	Image sensor and infrared filter.
5	Light sensor	Detects the lighting conditions: color by day and infrared by night.
6	Viewing screen	Allows the user to access the main menu and view photos/videos.
7	Fresnel lens	Expands the detection area and increases the sensitivity of the camera's motion sensor.
8	Test light	Flashes in TEST mode when there is detection and flashes 30 seconds in PHOTO/VIDEO mode to allow the user to leave without being photographed or recorded.
9	Navigation buttons	Buttons to set the camera.
10	On-Off Switch	Allows the user to turn on/off the camera.

11	SD card slot	An SD card is required to record photos/videos
12	Battery case	Case for AA batteries or a rechargeable lithium battery pack.
	Micro SIM card slot	A micro SIM card is required for cellular functions. (included)
13	Slot for installation strap	Allows the user to install the camera using the installation strap included.
14	Locking latch	Allows access to the front controls of the camera.
15	Cable lock hole	Allows the user to install a CL-6FT cable lock, sold separately.
16	12V power jack	This camera can be powered from an external 12-volt DC input such as a 12V battery or a 12V adapter, each sold separately.
17	Microphone	Records sound in video mode.
18	Tripod mount	Standard ¼-20" tripod mount.
19	Battery door push button	Allows you to access the battery compartment.

LINK-S & LINK-S-V

Cellular transmission

Frequency	LINK-S: 4G LTE LINK-S-V: 4G LTE (Verizon network)
Photo transmission	Wireless photo transmission via the free, SPYPOINT LINK App with a SPYPOINT plan. For more information, please visit the link below. WWW.SPYPOINT.COM/PLANS
Configuration	Fully configurable remotely through the free SPYPOINT LINK App.

Photo recording

Photo resolution	12 MP
File format	JPG
Time lapse mode	Predefined intervals from 3 min to 1 h
Multi-shot mode	Up to 3 photos per detection
Stamp	Date, time, temperature (°C/°F) and moon phase
Capture mode	Color by day, infrared by night

Video recording

Video resolution	1280 x 720 (HD 720p)
File format	AVI
Sequence length	Adjustable from 10 to 90 s
Stamp	Date, time, temperature (°C/°F) and moon phase
Capture mode	Color by day, infrared by night

Audio

Sound recording (automatically recorded in video mode)	Mono
--	------

Memory storage

Support	<ul style="list-style-type: none"> •Internal memory: none •External memory : SD/SDHC card (up to 32 GB)
---------	---

Viewing

Built-in screen	ACL 2.0"
-----------------	----------

Power source

Internal rechargeable battery	
-------------------------------	--

Optional power sources

Alkaline or lithium batteries	8 x AA
Lithium battery pack	Rechargeable battery pack (LIT-09/LIT-C-8)
External (12V jack)	12V battery (KIT6V-12V, KIT-12V, BATT-12V) or 12V adapter (AD-12V)

Detection system

Motion sensor	PIR
Detection angle	40°
Detection distance	Up to 100 ft
Trigger speed	0.07 sec
Delay between each detection	Adjustable from Instant to 30 min

Night time illumination system

LEDs	42 LEDs
Type	Super low glow LEDs
Flash range	Up to 100 ft
Exposure	Automatic infrared level adjustment

Optical field of view

40°	
-----	--

Dimensions

3.8" W X 6.9" H X 3.9" D	
--------------------------	--

Recommendations

Operating temperature	(-30 °C to + 50 °C) (-22 °F to +122 °F)
Storage temperature	(-40 °C to + 60 °C) (-40 °F to +140 °F)

INTERNAL RECHARGEABLE BATTERY & SOLAR PANEL

First, look at the internal battery percentage in the DETECTION TEST menu. If the percentage is low and the battery logo is not green, you will need to charge the camera for 24-48 hours before use. While charging, make sure the camera is turned off and the solar panel is facing down so it does not interfere with the USB charging process.

Plug the cable from the 12V port at the bottom of the camera and connect it to a USB port. (ex. USB power adaptor or a computer that will stay awake while charging) Once plugged, the screen will turn on and it will show the charging battery level for 10 seconds. Press the OK button once more to see the battery level reappear.

- When a single line remains, the camera will continue to take photos. If a video is being recorded and the battery level reaches 25%, the camera saves the file before shutting down.
- If the power of the internal battery becomes insufficient, the camera will shut down. Once the battery has been charged sufficiently by the solar panel, the camera will automatically turn on leaving the settings untouched.
- An optional power source can be added as a backup to the internal rechargeable battery for maximum protection.
- Make sure that there are no objects obstructing the solar panel, that it is not shaded by unwanted obstacles and/or foreign materials.
- You need at least 50% of the solar panel cleared for maximum performance.

OPTIONAL POWER SOURCES

AA BATTERIES

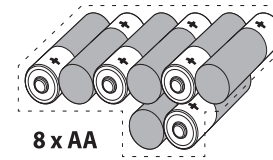

This camera can be powered by 8 AA batteries (1.5V). The use of alkaline or lithium batteries is recommended.

 To ensure maximum performance of the camera and prevent battery leaks, we recommend the use of new batteries. Make sure to insert each battery with the correct polarity. (Negative or flat end against the metal spring plate) Do not mix battery type - use ALL alkaline or ALL lithium. Do not mix old and new batteries. Rechargeable AA batteries are not recommended as the lower voltage can cause operational issues.

LITHIUM BATTERY PACK

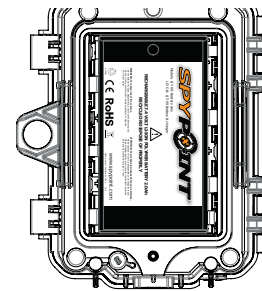

This camera can be powered by a rechargeable lithium battery pack LIT-09/LIT-C-8 (sold separately). This type of battery is less affected by cold temperatures and lasts up to 2 times longer than alkaline batteries.

EXTERNAL (12V)

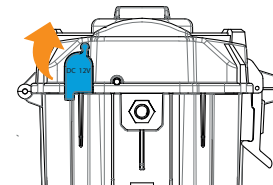

This camera can also be powered by an external 12-volt DC input such as a 12-volt battery (KIT-12V, BATT-12V or KIT6V/12V) or a 12-volt adapter (AD-12V), sold separately. You can't plug another solar panel directly in the 12-volt port as it will not recharge the internal battery. You may use an external 12v battery and plug another solar panel on it if you do choose so.

Memory card / "BUSY" LED



MEMORY CARD

A memory card is required to record photos and videos. The camera is compatible with SD/SDHC memory cards, up to 32 GB capacity (sold separately).

The screen displays "Insert Memory Card" when the camera is turned on and no memory card is used.

Here is a table of the approximate number of photos and length of videos that can be recorded with different memory card capacities. Many photo and video resolutions are noted, see those corresponding to the camera.

Note: This SPYPOINT camera is equipped with continuous file recording. When the memory card is full, the camera will continue to record photos or videos by deleting the first recorded files.

	4 GB	8 GB	16 GB	32GB
Photo				
12 MP	1600	3200	6300	12600
Video				
1280 x 720	40 min	1h20	2h40	5h20

INSERTING THE MEMORY CARD

Before inserting or removing a memory card, always turn off the camera to prevent loss or damage of the photos already recorded. Also make sure that the switch on the side of the card is not in the LOCK position.

Insert an SD/SDHC memory card (up to 32 GB capacity) in the card slot with the label side facing upward. The card is inserted correctly when a click is heard.



 We suggest to format your SD card if it's been in another electronic device to make sure you will have the maximum capacity of your memory card.

REMOVING THE MEMORY CARD

Lightly press the memory card into the camera once to pop it out of the slot and remove it.

BUSY LED

The BUSY light is located at the back of the camera. It is a diagnostic tool. It lights up when the camera starts, when the camera records a file and in TEST mode at the same time as the test light (located in front of the camera).



Settings

Use the ↑ and ↓ buttons to navigate in the interface and modify the selection, the OK button to select and the ↵ button to return to the previous menu.

START CAMERA
Allows the user to start the camera in either, **PHOTO**, **VIDEO** or **TIME LAPSE** mode. When a mode is selected, the test light in front of the camera will flash for 30 seconds and a countdown will appear on the screen to allow the user to leave the area without being photographed.

DETECTION TEST
Allows the user to test the detection system of the camera. When the **DETECTION TEST** mode is selected, no photo or video is recorded. Walk perpendicularly in front of the camera. When the camera detects a movement, the busy light blinks to indicate that normally, a photo or video would have been recorded. If the system does not detect the movement, increase the detection distance using the "Sensitivity" option in the settings menu. Realigning the camera can also be required.

VIEW
Allows the user to view or delete recorded photos and videos on the camera screen.

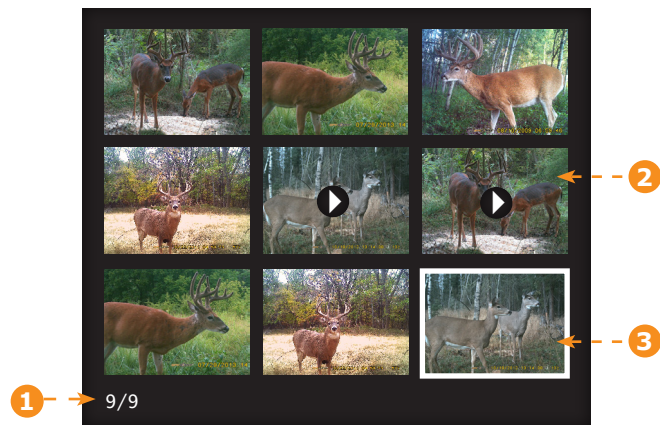

- 1 Selected photo / total number of photos
- 2 The play icon indicates that this element is a video
- 3 The outline indicates which photo is selected

Viewing with the screen of the camera:

When the **VIEW** mode is selected, the latest photos or videos recorded appear as thumbnails on the screen. Press ▲ or ▼ to navigate this page, and press OK to view a photo in large format. To view the next or previous large photo, press ▲ or ▼. Press back to return to the thumbnail view.

When a large photo is open, press OK to view the different options available:

Play:	Allows the user to play or pause the video on the screen (this option is available only for videos).
Zoom:	Allows the user to zoom in or out.
Date and time:	Allows the user to view the date and time printed on the photo.
Protect:	Allows the user to protect a photo or video to prevent it from being deleted by selecting "Erase All".
Erase:	Allows the user to erase the photo or the video seen on the screen from the memory card.
Erase all:	Allows the user to erase from the memory card all stored photos and videos, with the exception of protected files.
Format:	Allows the user to format the memory card and delete all protected photos and videos.
Exit:	Allows the user to exit the menu and return to the viewing screen.

SETTINGS
Allows the user to the different settings on the camera. From **PHOTO**, **VIDEO**, **TIME LAPSE**, **WIRELESS** or **GENERAL** settings.



PHOTO SETTINGS

Sets the options of the PHOTO mode.

Recommended settings

The camera can be configured for **usage in trails**. This situation usually presents low activity level, fast subjects and a small number of photos is expected. These settings increase the chances of capturing animals that follow each other.

The camera can also be configured for **usage at a feeder's site**. This situation usually presents high activity level, slow subjects and a large number of photos is expected. These settings moderate the number of photos taken while capturing overall activity on the feeder's site.

Here is a table showing the suggested settings for each situation:

	Trail	Feeder
Delay	Instant	5 min
Multi-shots	1	2-3



When these recommended settings are not adapted to the situation, battery life can be affected.

Delay: (Instant/10s/1m/3m/5m/10m/15m/30m)

Allows the user to choose the time interval between each detection before the camera records the next photo. A longer delay minimizes the number of photos taken and maximizes the battery life. A shorter delay maximizes the number of photos taken but requires more battery power. A shorter delay interval is recommended when the camera is used for security purposes.

Multi-shot: (1/2/3 consecutive shots)

Takes up to 3 consecutive shots at each detection, with a 5-second delay between each photo. This option allows the user to get up to 3 photos when the camera is in PHOTO mode.



TIME LAPSE SETTINGS

Sets the options of the TIME LAPSE mode.

Interval: (3m/5m/15m/30m/1h)

Allows the camera to take photos at regular preset intervals. For example, if the option "5m" is selected in the TIME LAPSE mode, the camera takes a photo every 5 minutes even if there is no detection. This option allows the user to obtain photos of game outside the detection range of the camera.

Note: The TIME LAPSE mode only applies for photos, not videos. When the TIME LAPSE mode is selected, the DELAY option and the MULTI-SHOT mode are disabled.



VIDEO SETTINGS

Sets the options of the VIDEO mode.

Delay: (Instant/10s/1m/3m/5m/10m/15m/30m)

Allows the user to choose the time interval between each detection before the camera records the next video. A longer delay minimizes the number of videos taken and maximizes the battery life. A shorter delay maximizes the number of videos taken but requires more battery power. A shorter delay interval is recommended when the camera is used for security purposes.

Video length: (10s/30s/60s/90s)

Allows the user to select the duration of the recording when the camera is set in VIDEO mode.

Photo first: (On/Off)

When this option is enabled, a photo is taken immediately before each video.

Note: The file name of the photo corresponds to the digit before the video file name. For example, if the name of the photo is PICT001.JPG, the name of the video will be VID001.AVI.



WIRELESS SETTINGS

Sets the wireless options of the camera.

Cellular: (On/Off)

Allows the user to turn ON or OFF the transmission of pictures

Frequency:

Allows the user to choose the number of synchronizations that the camera performs in a day, to send the pictures.

First sync time:

Allows the user to choose at what time of the day the camera communicates for the first time.

Sim options:

If needed, allows the user to unlock the SIM card with a PUK number provided by the SPYPOINT customer service.

GPS: (On/Off)

Allows the camera to send his GPS coordinates while it synchronizes.



GENERAL SETTINGS

Sets the general options of the camera.

Language: (English/Français/Deutsch)

Allows the user to select a language for the camera menus.

Date format: (MM/DD/YY, DD/MM/YY)

Allows the user to set the date as Month/Day/Year or as Day/Month/Year.

Time format: (12H/24H)

Allows the user to set to standard time or military time.

Date:

Allows the user to set the date

Time:

Allows the user to set the time

Sensitivity: (Low/Medium/High)

Allows the user to choose the sensitivity of the motion sensor.

The camera will only detect sources of heat in motion. Make sure to have the least possible objects in front of the camera during the positioning. This prevents the camera from taking photos when oriented towards the sun while an object is moving in front of the camera. (e.g. a branch)

Quality: (Normal/High)

Allow the user to set the photo quality. (5MP/12MP)

Schedule

Allows the user to set the period of operation of the camera for each day of the week. The start and stop time are the hours during which the camera is in action and can record pictures or videos. For an activation of 24 hours, the same start and stop time must be entered

Note: The hours can be recorded over a 12 or 24 hours period. Refer to the «Time format» option.

Battery type: (AA/LIT-09/12V)

Allows the user to select the battery type he is using to get a more precise battery level reading

Info on photos: (Yes/No)

Allows the user to have date, time, temperature and moon phases printed on the photos.

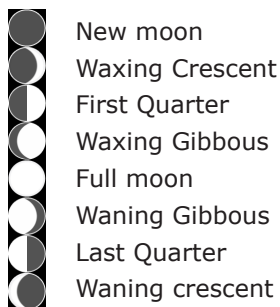

Night mode:

Allows the user to set the best option for photos.

	OPTIMAL MODE	IR-BOOST MODE	BLUR REDUCTION MODE
Battery life	★★★★★	★★★★★	★★★★★
Flash range	★★★★★	★★★★★	★★★★★
Blur reduction	★★★★★	★★★★★	★★★★★

* Available for photos only

Temp. units: (°C/°F)

Allows the user to select the temperature display.

About the device:

Allows the user to display system information:

- Software version number
- Hardware version number
- Model number
- SIM card number

& more.

Factory reset:

Allows the user to restore the device to its original state.

SPYPOINT LINK app

LINK-S

When you login in the SPYPOINT LINK app, it will bring you directly to the Photos tab. From there, you will be able to see right away the latest photos received as they are sorted by date & time.

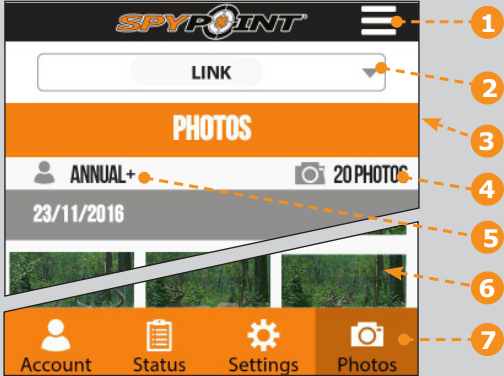

1 Message menu
2 Camera name
3 Current tab
4 Nb of picture
5 Plan
6 Photos
7 Tab selection

Account Status Settings Photos

WIRELESS SETUP OF THE LINK CAMERA

Note that any modifications of the settings through the app will carry over to the camera at the time of its next synch. All the settings in the App are the same one as in the camera. If you're not sure what a setting does, please refer to the previous section.



ACCOUNT

Select the data plan and modify your profile informations.

DATA PLAN

Select your data plan from Annual, Annual+ or Hunting (3 Months). If you choose not to activate a plan, note that you'll still be able to transmit/receive pictures with our FREE monthly plan. It will allow you to transmit/receive up to 100 photos per month with a photo history of the last 7 days.

MODIFY YOUR PROFILE INFORMATION

Modify your profile like Password, Name, Address, Phone number & more.



STATUS

See general informations of the camera.

LEVELS

See your camera Signal strength, Battery level, SD card space and more.

GENERAL INFORMATION

See your camera Model, Version, Last communication, Nb of pictures this month, Temperature and Battery type.



SETTINGS

Modify the settings, the synchronisation frequency & others

BASIC SETTINGS

Mode - PHOTO

Set Delay, Multi-shot, Sensitivity & Camera name.

Mode - TIME LAPSE

Set Interval.

Mode - VIDEO

Set Delay, Sensitivity, Photo first & Video length.

SYNCHRONISATION SETTINGS

Set Cellular transmission, First sync time & Sync frequency.

ADVANCED OPTIONS

Set the Date format, Temp. unit., Night mode and more.



PHOTOS

See your pictures by date, month and years. It also lets you share or download your photos.

- Scroll up or down to view your photos by date.
- Click on a photo to select it and see it larger.
 - Swipe left to see previous photo or right for the next one.
 - Click on the arrow at the top right of the screen to share the photo on facebook.
 - Leave your finger on a photo to be able to delete it from the App.
 - Swipe up or down to return to the PHOTOS tab & refresh the screen.

Installation & Mounting bracket

INSTALLATION

Recommended installation height:

The camera should be installed at the same height as the animal's mid-body.

Ideal installation for quality pictures & videos:

The targeted animal should be 25 feet / 7.5m away from the camera for a better field of view.

To get brighter pictures at night, you should have elements in the background to reflect back the IR flash to the camera. (e.g. Trees or fence)

Make sure the front of the camera is free of any obstructions. The area of installation should be cleared from branches or bushes. These could be responsible for triggering false detections when combined with heat, reflections and/or wind. Setting the sensitivity level of the camera too high can also result in false detections by unwanted movement.

MOUNTING BRACKET

To remove the camera from the mounting bracket:

1. Push the tab to release the camera from the mounting bracket.
2. Remove the camera.



INSTALLATION WITH THE SUPPLIED STRAP

Use the mounting bracket or the camera slot for installation strap to fix the camera. The dimensions of the strap (included) is 1" X 60".

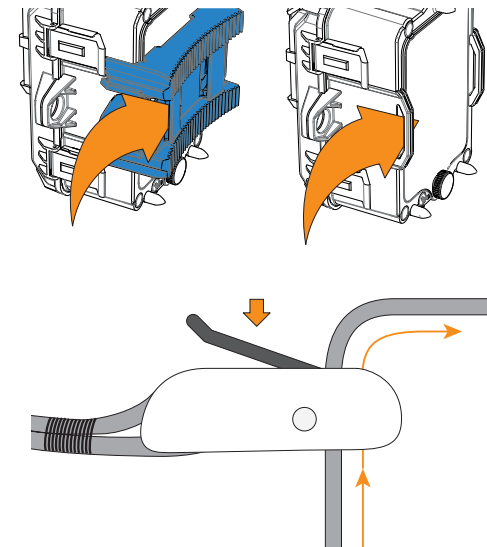

File transfer to a computer

To transfer photos/videos to a computer:

- Turn OFF the camera.
- Remove the SD card from the camera.
- Insert the SD card into the computer slot, or use a memory card adaptor.
- The computer will detect the card and install the driver automatically.



For a PC

Click on "My Computer" or «This PC» on your Desktop

Locate your device under "Removable Disk" and then click to access it. Then click on "DCIM" and "100DSCIM" to find all recorded photos and videos.

Select the photos you want to copy. The easiest way is to select them all by clicking on the Home tab and the Select all on the right-hand side. (You can also press Ctrl and the 'A' key, or click the Edit menu and choose select all in other versions of Windows)

Click the Copy icon on the left-hand side of the ribbon (or hold Ctrl and press C). [NOTE: If you don't want to select all photos, hold down the Ctrl key and click on the photos you do want to select before clicking the Copy icon]

Navigate to the folder in which you would like to store your images, or create a new folder by clicking the New Folder button in the ribbon. (You can also press Ctrl-Shift-N together to create a new folder, or right-click in some empty space in the Pictures folder and choose New, then from the next menu: Folder)

Type a name for your new folder, press Enter and then double-click on the folder to open it.

From the Home tab, choose Paste (or hold Ctrl and press V). The photos will be copied into the new folder.

For a Mac

Click the Finder icon in the Dock.

Locate your device under the Devices tab and then click to access it. Then click on "DCIM" and "100DSCIM" to find all recorded photos and videos.

Click Edit on the toolbar running along the top of the screen and then press Select All to highlight every single images on the device. Select All is also achievable by pressing the ⌘ and A key simultaneously on your keyboard.

Alternatively, if you do not wish to import all, you can individually highlight the images you would like to transfer by holding ⌘ and clicking the file-name.

Click Edit once again and then Copy (or ⌘ and C) to copy the highlighted images.

Navigate to the folder in which you would like to store your images, or create a new folder by right-clicking and pressing CTRL simultaneously, then select New Folder from the menu.

Click Edit and then Paste (or ⌘ and V) to copy your chosen images from your device to the selected folder.

Images may take several minutes to transfer depending on the file size and the amount of images you are importing.

Once your images have transferred, click the Eject icon situated alongside the name of your device and then unplug the device from your Mac.

Available accessories

LINK-S



Rechargeable 12V battery, charger & housing kit
#KIT-12V, 12-volt 7.0Ah rechargeable battery with a water resistant ABS plastic case, AC charger, 12 ft power cable



Lithium battery pack & charger
#LIT-C-8, Rechargeable lithium battery pack and AC charger with charge indicator light. Fits all SPYPOINT cameras.



12V DC Power cable
#CB-12FT, 12 ft power cable with alligator clips at one end to connect a 12V battery to a camera.



12-volt Adaptor
#AD-12V, AC adaptor (6V to 12V). Powers the camera from an electrical outlet.



Steel security box
#SB-200, Steel box to secure the camera against theft. It also protects it from breakage caused by bears or other animals. Fits all SOLAR 42 LED SPYPOINT cameras.



Camera mount
#MA-360, Adjustable mounting arm, fits all cameras that have a standard 1/4-20" tripod mount. It can rotate 360° and tilt approx +/- 90°. Also available in black.



Cable lock
#CL-6FT, 6 ft cable lock fits all SPYPOINT cameras.



SD Memory card 16GB
#SD-16GB, SDHC UHS-1 memory card 16 GB, ultra high speed Class 10.



Steel security boxes may reduce the wireless functionalities of the product.

To obtain more information on other available accessories, go to
www.spypoint.com

Issue	Possible solutions
Impossible to turn on the camera	<ul style="list-style-type: none"> Recharge the internal battery for 24h-48h. While charging, make sure the camera is turned off and the solar panel is facing down so it does not interfere with the USB charging process. Verify if there are batteries in the camera. Verify if the batteries are correctly installed. Replace alkaline batteries or recharge the lithium battery pack.
The screen of the camera turns off	<ul style="list-style-type: none"> The camera may be set to PHOTO or VIDEO mode and the screen turns off after a period of 30 seconds in order to preserve battery life. The camera automatically resets itself to PHOTO or VIDEO mode (depending of the latest mode used or selected) after 2 minutes of inactivity on the main menu. To return to the screen, turn off the camera and turn it on again.
The camera does not respond	<ul style="list-style-type: none"> Remove the batteries and reinstall them. Replace alkaline batteries or recharge the lithium battery pack.
Impossible to take photos/videos	<ul style="list-style-type: none"> Verify if there are batteries in the camera. Replace alkaline batteries or recharge the lithium battery pack. Verify if the camera is turned on. Format the memory card. Make sure the camera detects movement by doing a Detection Test.
Red light in front of the camera blinks	<ul style="list-style-type: none"> Camera is set in TEST mode. Camera is set in PHOTO or VIDEO mode. The red light in front of the camera flashes for 30 seconds to allow the user to leave without being photographed or recorded.

Camera takes black photos / videos	<ul style="list-style-type: none"> Verify the battery level to see if battery power is full as the flash will stop operating near the end of the battery life specially if you're doing a video. Verify that there's something within the flash range to reflect the infrared back to the camera. If you're unsure if the flash is working properly, test the camera in a dark room to see if you're able to have black & white pictures or videos.
Photos / videos appear dark at night	<ul style="list-style-type: none"> For best results, make sure the subject is within the ideal flash range. Subjects may appear too dark at greater distances.
Photos are blurry	<ul style="list-style-type: none"> Low lighting conditions and fast moving subjects, may produce streaks on the photo, try setting the "Night mode" to "BLUR" to reduce the motion blur.
No person/animal on photos	<ul style="list-style-type: none"> Sunrise or sunset can trigger the sensor. Camera must be re-orientated. At night, the motion detector may detect beyond the range of the IR illumination. Reduce sensibility setting. Small animals may trigger the unit. Reduce sensibility setting and/or raise height of camera. Motion detector may detect animals through foliage. If a person or animal moves quickly, it may move out of the camera's field of view before the photo is taken. Move the camera further back or redirect the camera. Make sure the mounting post or tree is stable and does not move.

Error message	Possible solutions
Insert memory card	The use of a memory card is required to record photos and videos.
Card error	<p>The camera cannot access the memory card.</p> <ul style="list-style-type: none"> • Turn off the camera and turn it on again. • Turn off the camera, then remove the SD card and insert it again. The card is inserted correctly when a click is heard. • Verify if the gold contacts are clean. • Format the memory card.
Low battery	Appears on the screen just before the camera turns off. Recharge the batteries or insert new ones. Always verify the battery level before using the camera.
No image	<p>The camera does not see any pictures/videos.</p> <ul style="list-style-type: none"> • Verify if the SD card is not locked. • Verify if the memory card contains photos/videos with a computer.
Protected file	<p>The file you want to delete is protected.</p> <ul style="list-style-type: none"> • Unprotect the photo in the View mode, then you will be able to delete this file. • Format the memory card to delete this file and all the others.
Error: No SIM card	<p>The SIM card is missing or defective.</p> <ul style="list-style-type: none"> • Turn off the camera and turn it on again. • Turn off the camera, then remove the SIM card and insert it again as shown on the camera. The card is inserted correctly when a click is heard.

Error: SIM card	<p>The SIM card is defective.</p> <ul style="list-style-type: none"> • Turn off the camera and turn it on again. • Turn off the camera, then remove the SIM card and insert it again as shown on the camera. The card is inserted correctly when a click is heard.
Error: SIM locked	<p>Your SIM card is locked.</p> <ul style="list-style-type: none"> • Contact the SPYPOINT customer service.
Error: SIM locked (PUK)	<p>Your SIM card is locked and requires a PUK.</p> <ul style="list-style-type: none"> • Contact the SPYPOINT customer service.
Error: SIM card not supported	<ul style="list-style-type: none"> • The camera must use the Truphone SIM card provided with the camera.
Error: No service	<p>The SIM card does not detect any signal.</p> <ul style="list-style-type: none"> • Move outside or near a window and re-start the camera a few times if required to get all the informations from the cell network.
Error: Modem	<p>There has been a communication problem between the camera and the modem.</p> <ul style="list-style-type: none"> • Turn off the camera and turn it on again.

SIT BACK, RELAX & KNOW YOU'RE COVERED



This SPYPOINT product designed by GG Telecom, is covered by a two (2) year limited warranty on material and workmanship starting from the original date of purchase. The electronic sales receipt is the client's proof of purchase and must be presented if warranty service is needed. This warranty will be honored in the country of purchase only.

This GG Telecom warranty does not apply to: (a) consumable parts, including but not limited to batteries, which performance is designed to decrease over the course of time; (b) damage caused by misuse, use with another product, neglect, accidents, liquid contact, fire, earthquake or any other external cause; (c) GG Telecom products that have been purchased online from an unauthorized dealer; (d) products that have had any modification or tampering; (e) cosmetic damage including but not limited to scratches and broken plastic; (f) damage caused by operating the GG Telecom product outside of GG Telecom's recommendations.

INSTRUCTIONS FOR REPAIR SERVICE

GG Telecom will repair the product or replace it at its discretion with an equivalent product without charge if covered by the warranty described previously. The shipping fees for an item sent will be assumed by the customer. GG Telecom will then pay for the return of the product covered by the warranty.

For a product not covered by the warranty, the repair will be subject to a reasonable charge and the customer will also assume all shipping costs.

IMPORTANT: Under no circumstances will GG Telecom accept returned products without a RMA number. (Return Material Authorization) It is essential to contact GG Telecom before making a return.

1. Before sending a product for repair, please contact GG Telecom technical support team at 1-888-779-7646 or support@spypoint.com as most issues can be solved over the phone or by email.
2. If a product needs to be sent, a RMA number will be given to authorize the return of the product and for future reference.
3. The original receipt or a copy must be sent along with the package.
4. The RMA number must be written on the outside of the package and sent to:

CANADA
GG Telecom
120 J.Aurèle-Roux
Victoriaville, QC
G6T 0N5

United States
GG Telecom
555 VT route 78
Swanton, VT 05488

The customer is liable for loss or damage to the product that may occur during the transport to GG Telecom. We recommend the use of a traceable method of shipping to ensure protection.

WWW.SPYPOINT.COM

FCC REGULATIONS



FCC Part 15

This equipment has been tested and found to comply with the limits for a Class B digital device, pursuant to Part 15 of the Federal Communications Commission (FCC) rules. These limits are designed to provide reasonable protection against harmful interference in a residential installation. This equipment generates, uses and can radiate radio frequency energy and, if not installed and used in accordance with the instructions, may cause harmful interference to radio communications. However, there is no guarantee that interference will not occur in a particular installation. If this equipment does cause harmful interference to radio or television reception, which can be determined by turning the equipment off and on, the user is encouraged to try to correct the interference by one or more of the following measures:

- Reorient or relocate the receiving antenna.
- Increase the separation between the equipment and receiver.
- Connect the equipment into an outlet on a circuit different from that to which the receiver is connected.
- Consult the dealer or an experienced radio/TV technician for help.

Changes or modifications to this equipment not expressly approved by the party responsible for compliance could void the user's authority to operate the equipment. This device complies with Part 15 of the FCC rules. Operation is subject to the following two conditions: (1) this device may not cause harmful interference, and (2) this device must accept any interference received, including interference that may cause undesired operation.