

GardePro[®]

T5CF Trail Camera

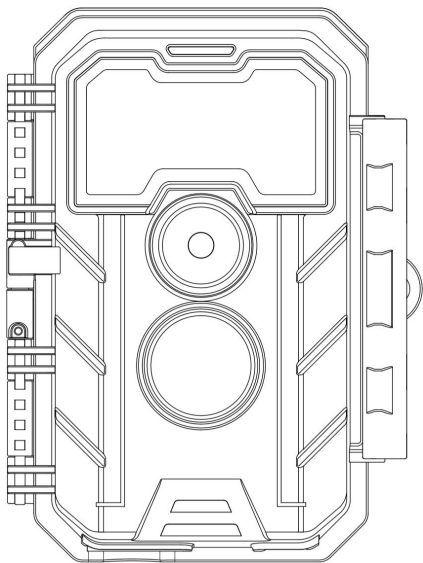

INSTRUCTION MANUAL

V1.0

Congratulations on your purchase of one of the best trail cameras on the market! We appreciate your business and want to earn your trust. Please refer to the notes below and the instructions in this manual to ensure that you are completely satisfied with this product.

In case of any further questions or concerns, please get in touch with us at:

support@zopudt.com

or visit our page:

www.zopudt.com

TABLE OF CONTENT

1. IN THE BOX	1
2. IMPORTANT NOTE	1
3. INTRODUCTION	2
3.1. ABOUT THE CAMERA	2
3.2. MAIN FEATURES	2
4. PARTS AND CONTROLS	3
5. INSTALLING THE BATTERIES AND SD CARD	7
5.1. LOADING BATTERIES	7
5.2. INSERTING THE SD CARD	8
6. USING THE CAMERA	9
7. THE OFF, ON, AND SURVEILLANCE MODES	10
7.1. OFF MODE	10
7.2. ON MODE	10
7.3. SURVEILLANCE MODE	11
8. ADVANCED SETTINGS	11
9. MOUNTING AND POSITIONING	16
9.1. MOUNTING	16
9.2. SENSING ANGLE AND DISTANCE TEST	17
9.3. STARTING	19
10. REVIEW PHOTOS OR VIDEOS	20
11. TECHNICAL SPECIFICATIONS	21
12. TROUBLESHOOTING	23

1. IN THE BOX

1 x Camera, 1 x Mounting Strap,
1 x Instruction Manual, 1 x Mini USB Cord

Note: Memory card and batteries are not included (user supplied).

2. IMPORTANT NOTE

Require eight (8) 1.5V AA Alkaline or Lithium batteries. We recommend the use of Energizer AA Lithium batteries in this camera to obtain maximum battery life.

Do not mix old and new batteries. Do not mix battery type.

Rechargeable NiMH AA batteries can be used, but the lower voltage (generally 1.2V) they produce has short lifetime, you may have to replace them frequently.

Remove batteries when the camera is NOT in use.

Require a standard-size SDHC/SDXC memory card (maximum capacity 512GB, Class 10). Recommend using SanDisk 32GB SDHC Class 10 memory cards in the camera to obtain the best cost-performance.

Before first use, please format your SD card in the camera by using "Format SD Card" in the menu settings.

3. INTRODUCTION

3.1. ABOUT THE CAMERA

The GardePro T5CF trail camera is a new generation of digital scouting camera, it can be triggered by any movement of game in a location, detected by a highly sensitive Passive Infra-Red (PIR) motion sensor, and then take high quality pictures (up to 32MP still photos), 1296P 20fps or 1080P 30fps H.264 video clips with audio.

The camera features the all new innovative and ultra-clear Sony imaging technology. The camera encompasses all-new software innovations, smart illumination technology, blur reduction technology, auto noise reduction and dynamic exposure technology to deliver high resolution image quality.

3.2. MAIN FEATURES

- High quality pictures (max 32MP still photos) or HD H.264 1296P 20fps or 1080P 30fps H.264 video clips with audio. The camera is equipped with a premium f/2.0 great aperture lens, it can take clear photos of animals as close as 8 in. (20cm).
- Clear night vision. The camera is equipped with 28pcs high performance infrared no glow 940nm LEDs that function as a flash (invisible to human and animal eyes).
- Wide view angle - 130°.
- Easy to use with well-designed operation buttons and built-in 2.4-inch color screen, easy to program, review pictures and videos on the screen.
- 3 working modes - Motion detection, Time lapse and

Hybrid.

- Fast trigger time - approx. 0.2s, Fast recovery time - 0.5s, Long trigger distance up to 90ft, Detection Angle - 70°.
- Info strip on each capture: Date, Time, Temperature & Moon phase.
- Operation hours, Loop recording, Password protected.
- Built for any climate - IP66 Waterproof designed for outdoor use and resistant against rain and snow. Operation Temperature: -4~140°F / -20~60°C.
- Support SD/SDHC/SDXC memory card, max capacity 512GB (*not included in the scope of delivery*).
- Extremely long in-field battery life up to 8 months in a stand-by state with 8 AA 1.5V batteries (*not included in the scope of delivery*).

4. PARTS AND CONTROLS

The camera is equipped with 28pcs high efficiency infrared LEDs, LED Indicators, Optical Lens, PIR Sensors, Lock Holes in front view (*Figure 1*).

TIP: During use, the black PIR Lens may be dirty or have scratches, however it does not affect the performance due to the reliability design. If you must clean it, please try to blow it off or pick out the dirt very lightly. Please do not try to wipe it, which may cause more scratches.

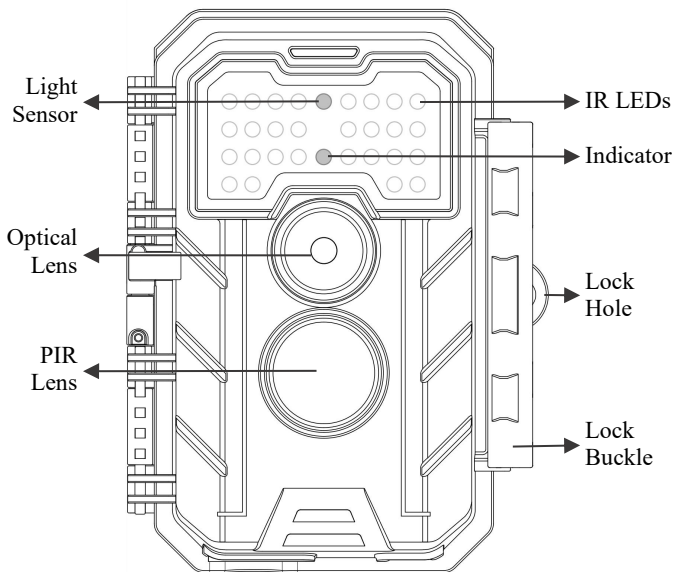
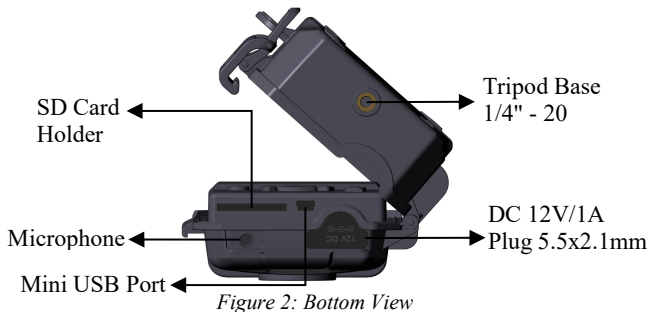

Figure 1: Front View

The camera provides the following connections for external devices: Mini USB port and SD card slot etc. (*Figure 2*).



The camera has one security cable hole and two strap holes on the back. The strap can be put through the strap holes and fastened securely around the tree trunk by pulling the end of the strap firmly (*Figure 3*).

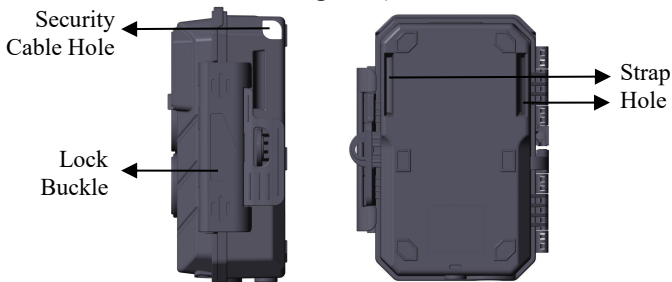

Figure 3: Right / Back View

The camera has a 2.4-inch built-in LCD screen, which can be used for reviewing pictures or videos and menu displaying, and exclusive keypad design for easy program

and operation, 8 AA batteries slot supported (*Figure 4*).



Figure 4: Inside View

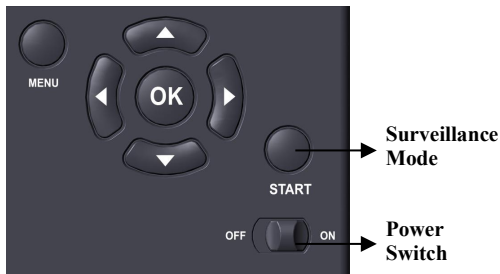

Figure 5: Operation Buttons

A power switch is used to power on (**ON** mode) or off the camera (**OFF** mode). A **START** button is used to quickly make the camera into the surveillance mode (motion detection) or time lapse per your settings (*Figure 5*). When the camera is in the surveillance mode, press the **START** button to wake up the camera.

5. INSTALLING THE BATTERIES AND SD CARD

Before you begin learning how to use your camera, you will first need to install a set of batteries and insert an SD card. Although that may only take you a minute, there are some important notes about both batteries and SD cards you should be aware of, so please take the time to **read the following directions and cautions**:

5.1. *LOADING BATTERIES*

After opening the cover of the battery compartment, you will see that the camera has eight battery slots (*Figure 6*). A full eight batteries must be installed for the camera to operate. Be sure to insert each battery with correct polarity (negative or "flat" end against the long spring of each battery slot).

In **ON** mode when battery power level gets low, the message "**Low Battery**" will show on the screen, please replace the batteries. If the battery indicator shows in **RED**, this does mean the batteries are not able to drive IR LEDs flash at night, however the batteries still work at daytime until "Low Battery". If you want to continue night vision, please replace the batteries.

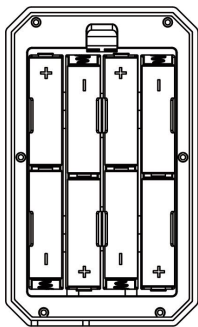

Figure 6: Loading the Batteries

5.2. INSERTING THE SD CARD

Insert the SD card (with the camera powered off), before beginning to operate the camera. Don't insert or remove the SD card when the camera is powered on or in the surveillance mode (Figure 7).

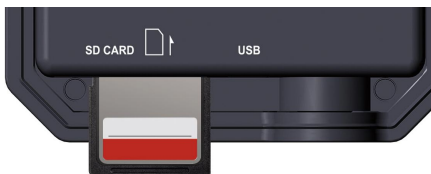

Figure 7: Inserting the SD Card

The following describes how to insert and remove the SD card:

- Insert the SD card into the card slot with its label side upwards. A "click" sound indicates that the card is installed successfully. If the wrong side of the card is facing up, you will not be able to insert it without force, there is only one correct way to insert cards. If the SD

card is not installed correctly, the device will not display an SD card icon on the screen in **ON** mode. **Formatting the SD card** by using the camera's "Format SD Card" menu option before first use is recommended, especially when a card has been used in other devices.

- To take out the SD card, just gently push in the card (do not try to pull it out without pushing in first). The card is released from the slot and ready to be removed when you hear the click. Be sure the camera's power is switched **OFF** before inserting or removing SD cards or batteries.

6. USING THE CAMERA

Once you've prepared your camera by properly installing batteries and an SD card, you could simply take it outside, strap it to a tree (or not - according to your application scenario), switch it **ON**, press **START** button and leave-and you might get some great photos that are exactly what you wanted. However, we highly recommend that you first spend some additional time indoors with this manual and your camera until you know a bit more about what those control keys do. If nothing else, you'll probably want to at least set the date and time so the camera will imprint them (or not-it's your option) on your photos as they are taken, learn how to set the camera to shoot video clips instead of still photos if you like, and read some tips about mounting it on a tree.

7. THE OFF, ON, AND SURVEILLANCE MODES

The camera has three basic operational modes:

- **OFF** mode: Power switch in the **OFF** position (The camera is powered off).
- **ON** mode: Power switch in the **ON** position (The camera is powered on and its screen is on).
- **SURVEILLANCE** mode: When the camera is powered on, press **START** button to enter the surveillance mode. When the screen is off, the camera enters standby and will perform according to your settings.

7.1. OFF MODE

The **OFF** mode is the "safe" mode when any actions must be taken, e.g., replacing the SD card or batteries, or transporting the device. And of course, when you are storing or not using the camera, you will switch it to **OFF**. Please note that in the **OFF** mode the camera will still consume a little power. It's a good idea to take the batteries out of the battery compartment if the camera will not be used for a long time.

7.2. ON MODE

In the **ON** mode you can check and change the settings of the camera with the help of its built-in screen. These settings, found in the menu by pressing **MENU** key, let you change the photo or video resolution, interval between photos, switch the time imprint on, etc. (*See more in Section 8 ADVANCED SETTINGS*).

On the screen display, you will see an information screen

that shows how many images have been taken, the battery level, camera or video mode, etc.

***Attention please:** In the **ON** mode, the camera will automatically enter **SURVEILLANCE** mode if there is no operation (key pressing) within 5 minutes. Then the camera will perform as your settings in the menu.*

In the **ON** mode, you can connect the camera to a computer's USB port to download your images.

7.3. SURVEILLANCE MODE

Anytime after the batteries and SD card have been inserted, you can switch on the camera. When the **START** button is pressed, the camera will enter into the **SURVEILLANCE** mode. If the Mode in the settings is set as "Motion Detection", the camera will count down a 30-second delay and then be ready to capture images. If the Mode is set as "Time Lapse", there will be no 30-second counting down, and the camera will be ready to enter Time Lapse.

Once in the **SURVEILLANCE** mode, no manual controls are needed or possible (the control keys have no effect). The camera will take photos or videos automatically (according to its current parameter settings).

You can press the **START** button again to wake up the camera and reprogram your camera if required.

8. ADVANCED SETTINGS

The trail camera comes with preset manufacturer settings. You can change the settings to meet your requirements. Once the camera screen is on, press **MENU** key to

enter/exit the menu. Press the **UP/DOWN** key to move the marker, Press the **LEFT/RIGHT** key to change the setting, and press the **OK** key to confirm the change. Always remember to press the **OK** to save the change. Otherwise you will lose your new setting.

Parameter	Settings (Bold = default)	Description
Mode	Motion Detection, Time Lapse, Hybrid	In Motion Detection mode, the camera will take photos or videos once triggered. In Time Lapse mode, the camera will take photos or videos periodically according to your preset "Timelapse Interval" parameter. Hybrid mode includes both above.
Photo or Video	Photo , Video, Photo+ Video	Select whether still photos or video clips are taken.
Photo Quality	32MP 24MP 16MP 8MP 4MP	Select desired resolution for still photos. Higher resolution produces better quality photos, but creates larger files that take more of the SD card capacity. Larger files require longer time to write to the SD card, which will slightly slow the shutter speed.
Photo Burst	01 , 02, 03, 04, 05	Select the number of photos taken in sequence per trigger.
Video Quality	1296P 1080P 720P	Select video resolution (pixels per frame). Higher resolution produces better quality videos, but creates larger files that take more of the SD card capacity.

Video Length	10 seconds, Optional from 3s to 5m	Select video recording length. <i>Note: It is highly recommended to set the night video length to less than 30 seconds as the IR LEDs will consume more battery power.</i>
Video Sound	On Off	Selecting On will record video with sound.
Video Format	MP4 MOV	MP4 is the mainstream format in the video industry, more compatible with any player. Select MOV in case some legacy digital camera software must be working with videos in MOV format.
Detection Delay	10 seconds, optional from 0s to 60m	Select the shortest length of time that the camera will wait until it responds to any subsequent triggers from the PIR sensor after a game is first detected. During the selected interval, the camera will not take pictures/videos. This prevents the SD card from filling up with too many redundant images. 0 means capture as fast as possible. <i>Note: this option is invalid if Mode is set as "Time Lapse".</i>
PIR Sensitivity	High, Medium Low	Select the sensitivity of the PIR sensor. Temperature affects the sensitivity. The High setting is suitable when the ambient temperature is warm or you want to capture distant objects or capture more, and the Medium/Low setting is helpful in cold weather. <i>Note: this option is invalid if Mode is set as "Time Lapse".</i>

Motion Test		This feature helps you aim the camera at your target area. Please refer to the details in Section 9.2.
Timelapse Interval	First Shot Time: hh:mm	Set the earliest shot time after Time Lapse or Hybrid mode is enabled. If you would like to get photos earlier, it is recommended to set it later than the current time.
	Interval: optional from 3s to 24h	Set time lapse interval. It takes effect ONLY when Mode is set as Time Lapse or Hybrid, the camera will automatically take photos/videos according to the set interval, regardless of whether the PIR sensor has detected any game. This is helpful when observing cold-blooded animals like snakes, or the process of flowering, etc. <i>Note: This option is invalid if Mode is set as "Motion Detection".</i>
Timelapse Period	On Off	Selecting On to set a specific working time period for your camera in Time Lapse mode or Hybrid mode. You can set up to 2 different time periods for the camera, and it will not capture time-lapse photos or videos outside of those periods. <i>Note: This option is invalid if Mode is set as "Motion Detection".</i>
Date/Time	M/D/Y hh:mm	M – Month, D – Day, Y – Year hh – Hour, mm – Minute <i>Note: Use "LEFT/RIGHT" key to switch parameters, use "UP/DOWN" to</i>

		<i>set current date and time. Date input format may change. Please refer to "Date Format" parameter settings accordingly.</i>
Date Format	D/M/Y M/D/Y Y/M/D	Select date format which will be shown on the screen and each capture.
Time Format	12h 24h	Select time format which will be shown on the screen and each capture. 12h - AM/PM
Camera Name	On Off	Select On to assign a 4-character long in the form of Capital A-Z, 0-9 to record the location in the photos (e.g. A123 for Yellow Stone Park). This helps multi-camera users identify the location when reviewing the photos.
Info Strip	On Off	Select On to show date, time, temperature, moon phase on each capture.
Loop Recording	On Off	Selecting On option will cause the oldest files to be overwritten with new captures when the SD card reaches its capacity. With Off option selected, the camera will stop capturing images once the SD card reaches capacity.
Operation Hours	On Off	Select On if you only want the camera to work within a specified time period every day. For instance, if the starting time is set at 18:35 and the ending time at 8:25, the camera will function from 18:35 the current day to 8:25 the next day. Outside the time period the camera

		will not be triggered. <i>Note: This option is ONLY valid if Mode is set as "Motion Detection" .</i>
Password	On Off	Set up a 4-digit password to protect your camera from unauthorized users. If the code is lost, you can contact customer support to reset the password.
Format SD Card	Yes No	All files will be deleted after formatting the SD card. We highly recommend you to format the SD card if it has been used previously in other devices. <i>Caution: make sure wanted files on the SD card have been backed up first!</i>
Factory Reset	Yes No	Selecting Yes will return all your previous settings back to the manufacturer default.
Version	Defined	Display the version of the camera.

9. MOUNTING AND POSITIONING

9.1. MOUNTING

After you've set up the camera's parameters to your personal preferences at home, you're ready to take it outside. When setting up the camera for scouting game or other outdoor applications, you must be sure to mount it in place correctly and securely. We recommend mounting the camera on a sturdy tree with a diameter of about 6in. (15cm). To get the optimal picture quality, the tree should be about 16-17ft. (5m) away from the place to be monitored, with the camera placed at a height of 2.5-3.5ft. (0.75-1m). Also, keep in mind that you will get the best results at night when the subject is within the ideal flash range, no farther

than 100ft. (30m) and no closer than 8in. (20cm) from the camera.

There are two ways to mount the camera: using the provided adjustable web belt, or the tripod socket.

Using the adjustable strap: Illustrates using the strap on the camera. Push one end of the strap through the two brackets on the back of the camera. Thread the end of the strap through the buckle. Fasten the strap securely around the tree trunk by pulling the end of the strap firmly so there is no slack left (*Figure 8*).

Using the tripod socket: The camera is equipped with a socket at the bottom end to enable mounting on a tripod or other mounting accessories with a standard *UNC 1/4-20* thread screw (*not included*).



Figure 8: Mounting the Camera

9.2. SENSING ANGLE AND DISTANCE TEST

To test whether the camera can effectively monitor the area you choose, this test is recommended to check the sensing angle and monitoring distance of the camera. To perform the test:

- Switch the camera to the **ON** mode.
- Press **MENU** button, go to "Motion Test". The camera will count down a max 60-second delay and be ready to capture motions. (*Note: The delay time may be less than 60 seconds, depending on the actual time of the motion sensor to be activated. The delay time is 60 seconds minus the power-on time.*)
- Close the camera door.
- Make movements in front of the camera at several positions within the area where you expect the game or subjects to be. Try different distances and angles from the camera.
- When the white motion indicator LED flashes in **RED**, it indicates that the camera is able to sense the position. However, if the LED doesn't blink, it means that the position lies beyond the sensing range.
- In these sensing tests, the camera would take pictures once motion captured. When you open the camera, the screen shows the number of times triggered, you can review the pictures on the screen.

The results of your testing will help you find the best placement when mounting and aiming the camera. The height away from the ground for placing the device should vary with the animal size appropriately. In general, 3 to 6 feet is preferred.

You can avoid potential false triggers due to temperature and motion disturbances in front of the camera by not aiming it at a heat source or nearby tree branches or bush (especially on windy days).

Do **NOT** install the camera behind the glass window as that is not possible to sense any motion. Avoid the camera

toward to glass objects.

9.3. STARTING

The camera supports three working modes, "Motion Detection", "Time Lapse" and "Hybrid", press **START** button to enter surveillance mode.

(1) If you set the camera's working mode as "Motion detection" in the menu, the camera will count down a 30-second delay, and then will be ready to go into standby (surveillance) and capture. Any motion that is detected by it will trigger the capture of an image or video as programmed in the menu. Be sure you have read the descriptions of the Detection Delay, and PIR Sensitivity parameters.

(2) If you set the camera's working mode as "Time Lapse" in the menu, the camera will be ready to go into "Time Lapse" mode soon after the START button is pressed, then will take images periodically according to your preset "Timelapse Interval" parameter, regardless of the settings "Detection Delay".

(3) If you set the camera's working mode as "Hybrid" in the menu, the camera will work according to the above two modes.

10. REVIEW PHOTOS OR VIDEOS

After you have setup, mounted and activated your CAMERA, you will of course be eager to return later and review the images it has captured for you.

The camera stores photos and videos in the folder \DCIM\100MEDIA in the SD card. Photos are saved with file names like NSCFCHAS_230626110308_0001.JPG and videos like NSCFCHAS_230626110308_0001.MP4. The "NSCF" field remains constant, the "CHAS" field corresponds to the camera name specified by the user, the "230626110308" indicates the precise time of the shot (here stands for "11:03:08 on June 26, 23"), and the "0001" is the file's serial number.

The MP4 video files can be played back on most popular media players, such as Windows Media Player, QuickTime, VLC etc.

There are different ways this can be done.

You can directly review the photos or videos on the camera screen.

Or the camera is powered on, you can use the provided USB cable to download the files to a computer.

Or you can put the SD card into an SD card "reader" (*not included*), plug into a computer, and browse the files on the computer without downloading.

11. TECHNICAL SPECIFICATIONS

Element	Description
Working Mode	Motion detection, Time lapse or Hybrid
Max. Pixel Size	32MP
Lens	f/2.0, FOV=130°, Auto IR-Cut
LCD Screen	2.4" Color screen
Keypad	7 Keys, 1 Power switch
Memory	SD, SDHC or SDXC standard memory card (<i>not included</i>), maximum capacity 512GB
Picture Resolution	32MP, 24MP, 16MP, 8MP, 4MP
Video Resolution	2304 x 1296P@20fps (16:9), 1920 x 1080P@30fps (16:9), 1280 x 720P@30fps (16:9)
PIR Sensitivity	High/Normal/Low
PIR Sensing Distance	90ft. (27m) (Below 77°F/25°C)
PIR Sensing Angle	70°
Trigger Time	Approx. 0.2 seconds
Trigger Interval	0sec.-60min, Programmable
Shooting Numbers	1~5
Video Length	3sec ~ 5min., Programmable
Info Strip	On /Off
Operation Hours	On /Off, Specific working period of time

Password	4-Digit Code
Camera Name	4-Character (A-Z, 0-9)
Time Lapse Interval	3 Seconds ~ 24 Hours
Power Supply	8x1.5V AA Batteries (<i>not included</i>)
Stand-by Time	8 Months in Stand-by
Auto Stand-by	Auto Stand-by (Surveillance mode) in 5 minutes while no operation in the ON mode
Low Battery Alarm	8V - Low Battery (Batteries die) 9V - Night vision is unavailable in low voltage (Almost die)
Interface	Mini-USB, Standard SD card holder, External Power (DC 12V/1A, Plug 5.5x2.1mm)
Mounting	Strap, Tripod Base (1/4-20)
Waterproof	IP66
Operation Temperature	-4~140°F/-20~60°C
Operation Humidity	5% ~ 95%
Certificate	FCC & CE & RoHS
Product Dimensions	5.6 x 4.2 x 2.86 inch

12. TROUBLESHOOTING

If your camera does not seem to be functioning properly or if you are having photo/video quality issues, please run these simple and quick checks:

- Make sure the camera is powered on and in the correct mode.
- Format the SD card in the camera or replace the SD card, since the SD card is a storage media and sometimes it might be unstable.
- Replace batteries if night vision seems not to be working as expected.

If your unit is still having trouble, please contact us, providing us with your order number, or **check the website to determine that you are using the latest firmware.** Please be assured we will make the things right for you.