

# ORX<sup>®</sup>

# USER'S MANUAL



MADE IN FRANCE BY



30/10/2018



# TECHNICAL INTRODUCTION

Congratulations on the purchase of your ORX and welcome to the world of research and exploration

You have invested in a high-tech metal detector capable of exceptional performance. The ORX has been designed and manufactured in France.

The ORX is innovative in terms of metal detector design as it offers a unique system based on different wireless elements communicating via a digital radio link. In this new design the coil and remote control have been made independent of each other through the integration of very compact high-capacity lithium batteries.

An ultra-miniature electronic circuit, incorporated in the search coil, digitises and analyses the signals. The signal is processed at the source and not conveyed via a wire link, which greatly improves data quality.

Incorporating components from leading-edge technologies such as scientific instrumentation, has enabled us to produce a powerful, rapid, lightweight, compact and fully controllable digital detector.

Whether you are an experienced user or a beginner, The ORX lets you decide whether or not to modify any of its remote control settings. Powerful pre-configured factory programs enable all users to get started immediately, while expert detectorists can choose more advanced parameters via the intuitive interface.

Lastly, the new patented XP stem has the combined advantages of an S-shaped stem and a straight telescopic stem. It enables you to deploy or fold away the device in just a few seconds, and to change the coil in an instant.

**So now you're ready for a new adventure!**



# ASSEMBLY HF COILS / REMOTE CONTROL

01

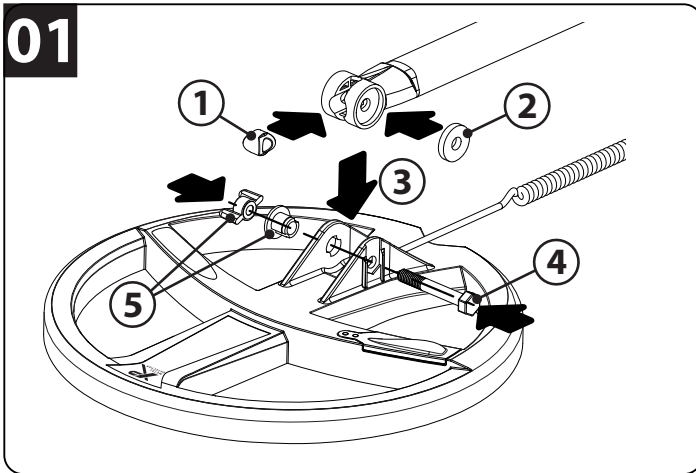

02

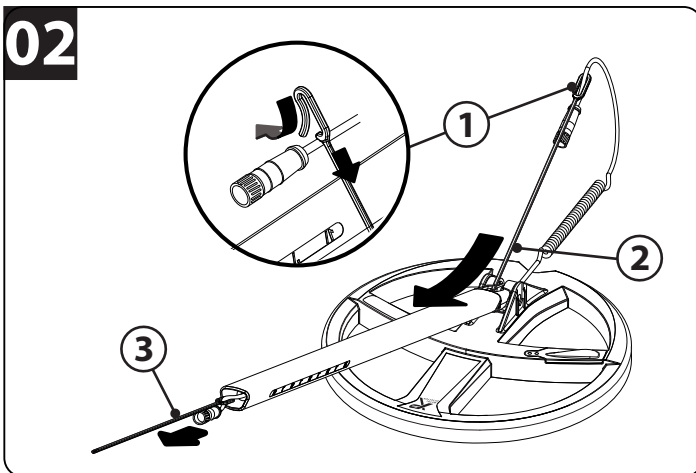

03

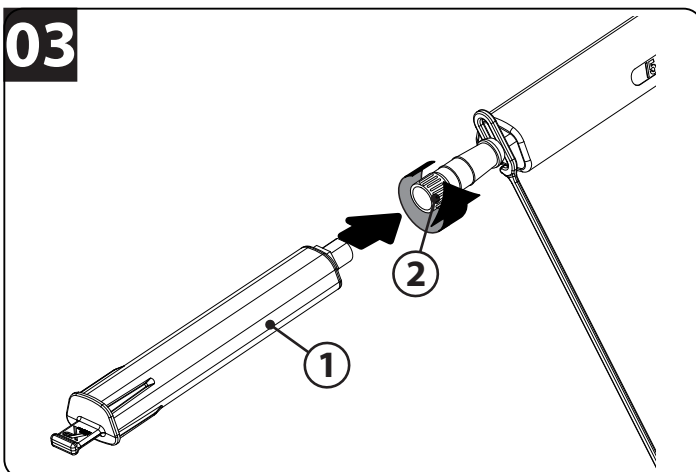

04

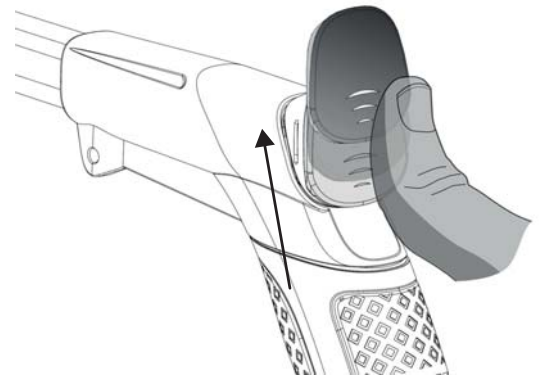
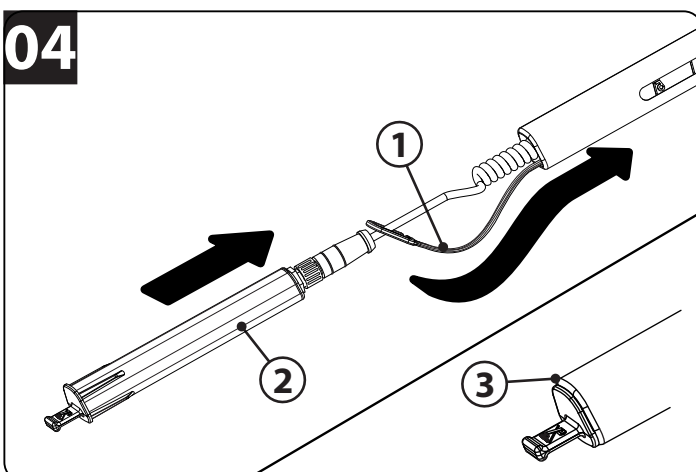

# FACTORY PROGRAMS

# 1 - GOLD	For low / average mineralisation, good sensitivity to medium and large sized Gold
# 2 - FINE GOLD	For heavy mineralisation / with good sensitivity to small and medium sized Gold
# 3 - COIN FAST	For coins and all types of targets good performance on mineralised or contaminated ground.
# 4 - COIND DEEP	For coins and all types of targets good performance on low mineralised / uncontaminated ground.
# 5 - USER	Customisable GOLD or COIN program.
# 6 - USER	Customisable GOLD or COIN program.

**Note :** The GOLD and COIN programs use different methods of signal processing.

## REMOTE CONTROL

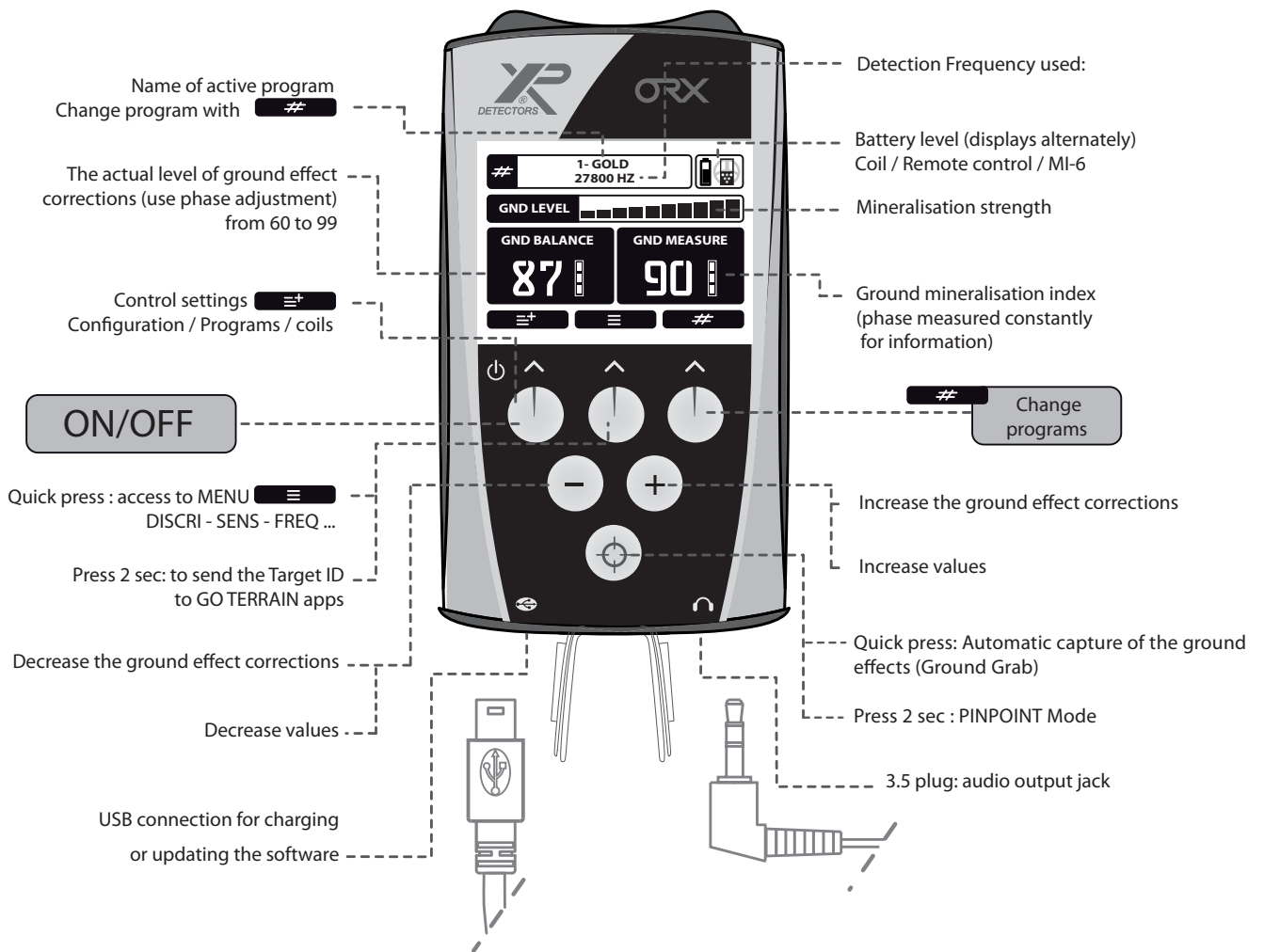

- Example of secondary screen :

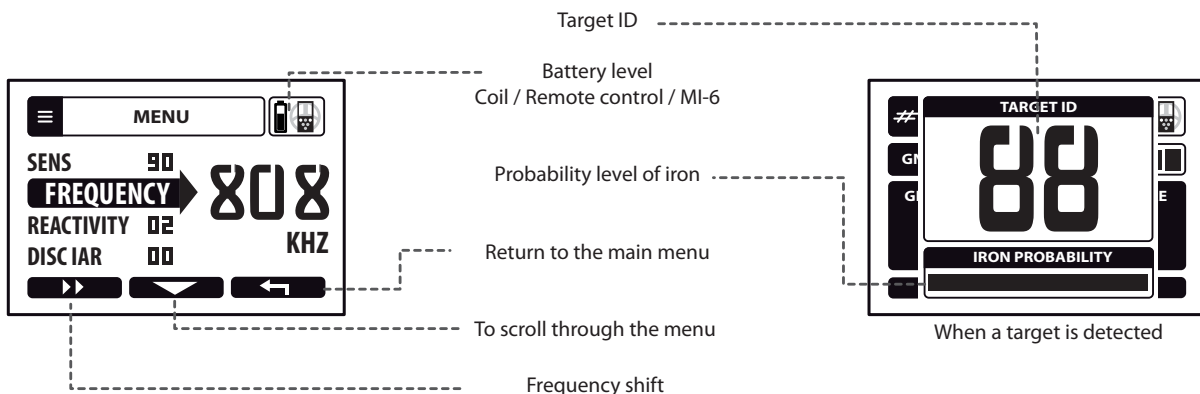

# MENU

## Configuring the main detection settings.

Press Scroll through the menu by pressing

### SENSITIVITY

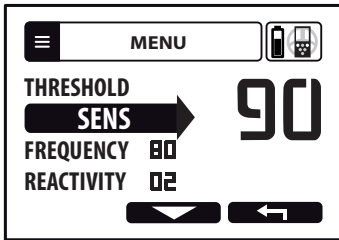

1 Adjust the Sensitivity level (from 0 to 99) with

2 Exit with

Sensitivity is often described as the setting which adjusts the device's power level. Increased sensitivity levels can enable the ORX to detect deeper targets but may cause an unstable operation. The most commonly used sensitivity levels range from 50 to 80. It may be necessary to reduce the level if there is too much interference.



Do not test your device in your home or in your garden as there is considerable electromagnetic and metallic interference in urban environments.

### FREQUENCY

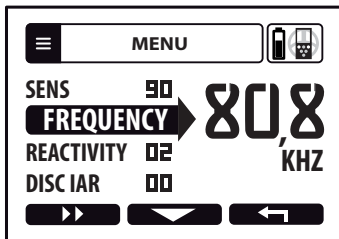

Scroll through the frequencies with

The ORX gives you the choice of three operating frequencies which cover most detection needs

- 22cm 9" coil : 15kHz, 30kHz and 50 kHz.
- Elliptical coil : 15kHz, 30kHz and 80 kHz.
- X35 coil : 4kHz, 8kHz, 12kHz, 17kHz and 25kHz.

They enable you to adapt your machine to suit a wide variety of soils and targets.

Here is a example of the most likely targets that may be detected according to the frequency:

4 / 8 / 12 / 15 / 17 kHz  
Large to medium sized targets

30 kHz  
Medium to small targets

55 kHz / 80 kHz  
Small to miniature targets

### FREQUENCY SHIFT

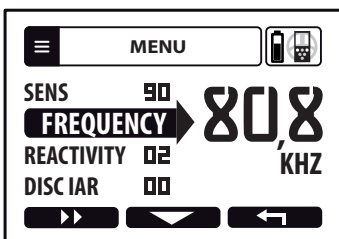

You can shift your operating frequency slightly to avoid interference generated by another detector in close proximity or electromagnetic interference (EMI).

Press to shift frequency

Channel 14K	13.3K	13.6K	14.0K	14.4K	14.8K	15.2K	15.6K
Channel 28K	26.6K	27.3K	28.0K	28.8K	29.6K	30.4K	31.3K
Channel 54K	50.0K	51.2K	52.6K	54.0K	55.5K	57.1K	58.8K
Channel 80K	68.3K	70.1K	72.0K	74.0K	76.1K	78.4K	80.8K

### IRON TONE

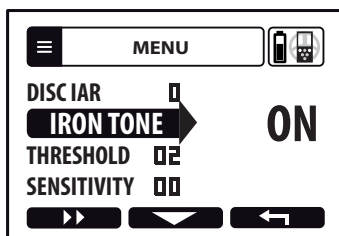

Activate / de-activate the low ferrous tone with

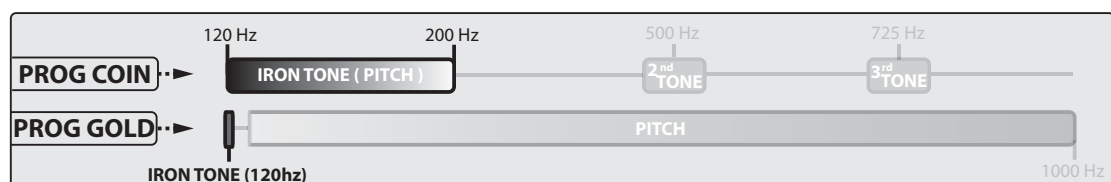

# MENU

## DISCRIMINATION IAR PROGRAMS 1 & 2 GOLD

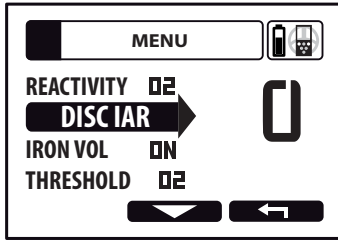

Adjust the IAR (Iron Amplitude Rejection) DISCRIMINATION from 0 to 5. It applies only to targets that produce strong signals – typically shallow ferrous items. IAR will not reject deeper targets which may come across as ferrous when they are buried in mineralised ground, This is to ensure good targets are not rejected by mistake. Gold nuggets (buried deep in mineralised ground) generate a similar target signature to a ferrous item. So in this case, it is better to reduce the level of discrimination.

Different tones to help with target identification :



## DISCRIMINATION PROGRAMS 3 & 4 COIN

Adjust the discrimination level from 0 to 99 with

Increasing the discrimination value enables you to gradually reject any target with a conductivity level lower than the selected setting. Ex: if you set the discrimination level to 10, you will reject iron with a value of between 0 and 10.

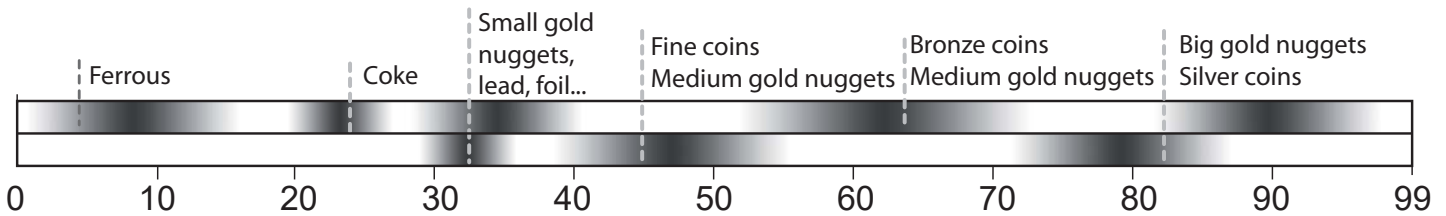

Different tones to help with target identification:

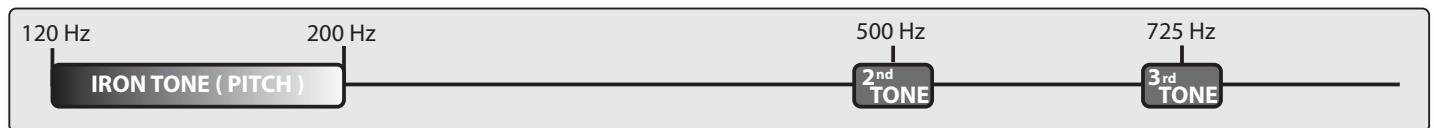

## THRESHOLD PROGRAMS 1 & 2 GOLD

Threshold is a faint background sound. Adjust the threshold from 0 to 20 with

## REACTIVITY

Adjust The Reactivity from 1 to 3 with

The Reactivity is a vital setting that determines the detector's performance in terms of how quickly it analyses the signal from detected targets, and its ability to separate the signals from several targets located close together. This is also known as Recovery speed. If the soil contains a great deal of iron, hot rocks or other mineralised debris, soil penetration is generally reduced. The ORX enables you to select a high degree of reactivity which will help you speed up the analysis of signals. However if the ground is "clean", it is better to reduce the Reactivity and sweep slower. The machine will be more sensitive to deep masses and obtain better ground penetration.

The ORX is a fast and selective detector ! Typical recommended Reactivity settings are as follows:

1	Large masses in ground with little iron contamination,
2/2.5	General use
3	Difficult soils contaminated with iron, hot rocks, etc.

In terms of pure performance, the greatest detection ranges are obtained with low reactivity levels. However, you will find more targets and will penetrate deeper in mineralised ground with medium or high reactivity levels.

# GROUND

## General features

Different levels of soil mineralisation can affect the performance of your detector. For example, this may be due to natural magnetic mineralisation such as iron oxide, hot rocks and magnetite, or sporadic mineralisation from sites of ancient habitation. Other magnetic items include: hearths, pottery, hot rocks, slag, etc. You may also experience high mineralisation from black sand and electrically conductive salt water (Depending on the beach region).

**Note :** If your ground is not mineralized (check mineralisation bargraph below), there is no need to adjust your ground balance to a level below 88: because the ground has not given a significant spurious echo indicating low mineralisation levels.

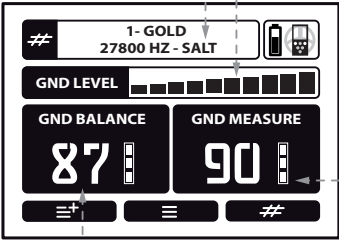



- **SALT mode :** Gold search on highly conductive soil ( salt lake or beach)  
Press **#** to enable or disable the salt feature.
- **Mineralisation strength:** The higher the bar graph, the more mineralized the ground is. Sweep the coil over the ground for 10 seconds to evaluate the mineralisation strength. If the level is low, there is less need to make any adjustments.
- **The ground mineralisation level**  
(measured constantly for information).
- **The adjusted level of ground effect**  
(User adjustment ).

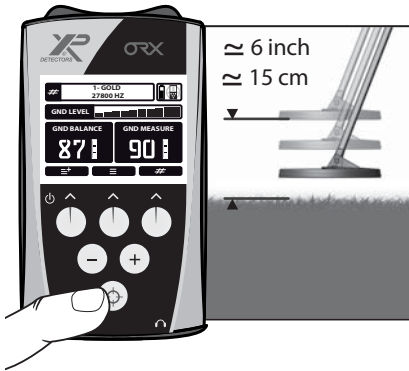

# GROUND

## AUTOMATIC MODE



On the controller, press the “Ground Balance” button  once briefly **while** pumping the coil to the ground. The ORX will grab and calibrate the current ground value and stabilise your ORX. The number on the lower left of the screen (GND BALANCE) displays the users set ground value.

Don't keep the “Ground Balance” button  pressed during this operation, just press it once **during** the pumping process.

If the ground is not eliminated well, follow the same procedure for a more accurate calibration.

**Restart the operation if the ground changes or it becomes unstable while searching.**

## MANUAL MODE

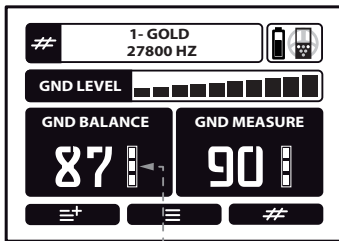

You can manually adjust the ground rejection levels

- 1 Note the right value (GND MEASURE)
- 2 By using  adjust the GND BALANCE to correspond with the GND MEASURE reading.

Each ground rejection level from 60 to 90 has additional units of fine tune increments to allow for a better ground adjustment.

## MODE SALT

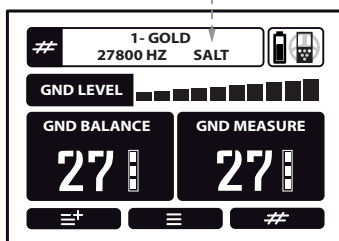

- On highly conductive soil ( salt lake or wet beach), activate the SALT MODE to stabilise the ORX.

Press and hold for 2 seconds  , to enable or disable the salt feature. The ground balance range is now adjustable from 0 to 30.

# OPTION

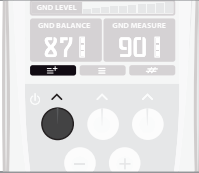

With the option menu you can save your settings, create new programs and configure your equipment's basic parameters. Press 

## CONFIGURATION

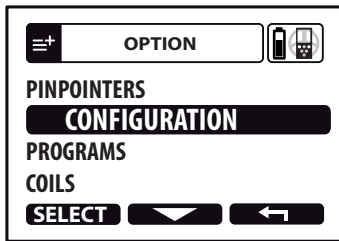

Choose  with  then press 

### Loudspeaker

Enables the remote control's loudspeaker to be activated or de-activated.

### Backlight

The backlight is activated as soon as a button is pressed and then switches off after a certain length of time. You can define this time in seconds: **OFF - 3s - 10s - 60s - 120s - ON (permanent)**

### Contrast

To improve readability in all lighting conditions you can adjust the contrast of the display.

### Language

Select your language

### GO TERRAIN

GO TERRAIN is an application for IOS or Android smartphones, designed to optimize your ORX experience. Key features are : Geo-locate, a real time map and the ability to make an inventory of your finds (More information on our website available coming soon).

### UPDATE







The software can be updated via a single USB to mini B cable and an Internet connection. Full information is available on our website: [www.xpmetaldetectors.com](http://www.xpmetaldetectors.com)

## PROGRAMS

Press  to change the programs

Choose from the 4 factory programs, you can modify them and create 2 additional user programs.

### Save a program

- 1 Press , choose  and press .
- 2 Select an unused slot (5 or 6) with  then press .
- 3 Validate with , your program is saved.

# OPTION







## COILS

### Pairing the remote control with a new coil

If you purchase an additional coil you need to pair it. Enter the coil serial number into the remote control to communicate with the ORX. The serial number is printed on the coil and on the invoice.



### Follow the following steps:

#### Entering the serial number

- 1 Press , choose **COILS** with  and press **SELECT**
- 2 Choose an unused slot (ex: 03: - - - - -) with  and press **SELECT**
- 3 At the point where the cursor is flashing, scroll through the characters using  and  and press  to advance to the next digit.
- 4 At the sixth digit press **VALID** then  x2 to return to the main menu. The remote control now adds this new coil to its list.

#### Select a coil from the list

To choose a coil:



- 1 Choose **COILS** with  and press **SELECT**
- 2 Press  to scroll through the list of available coils and select the one you wish to activate. The selected coil automatically becomes active after few seconds.

#### Delete a coil from the list

- 1 Choose the coil and press **SELECT**
- 2 Choose **EDIT SERIAL NUMBER** and press **SELECT**
- 3 Delete all Characters with  and replace with "000000", then press **VALID** and 

## HEADPHONES

Pairing your WS AUDIO with the remote control:

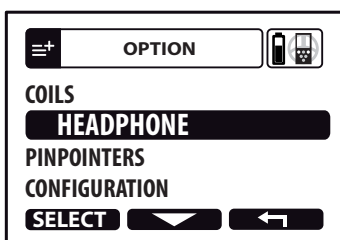

- 1 Press , choose **HEADPHONE** with  and press **SELECT**
- 2 Press the  button for 3 seconds to switch ON the WSA.



Press  to switch ON the WSA



Change the audio volume with  or 

Press  and  to switch OFF the WSA

\* Note the WSA will turn OFF automatically with the remote

USB mini B to charge

# OPTION

## PINPOINTER MI-6



When connected the MI-6 pinpointer transmits its audio signal directly to the DEUS, a new menu will now be available with extended functions.

### Pairing the MI-6 to the ORX

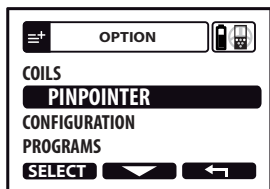

- 1 Choose
- 2 Press and select **PINPOINTER**
- 3 Turn on the MI-6, then hold the button down for 8 seconds
- 4 Once paired the MI-6 will operate with the DEUS.

**Note:** When pairing, the MI-6 automatically switches to program 7 (ORX / DEUS). This program will only work with the ORX. Program 7 will not generate any sound or vibration.

### Un pair the MI-6 from the ORX

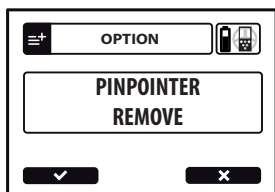

Choose select **PINPOINTER** and **REMOVE** finally press

**Note:** To use the MI-6 without the ORX, select programs 1 to 6 on the MI-6 menu. To change program: Switch MI-6 on - press the button for 5 seconds, a melody indicates that you have entered the program selection mode, press to correspond with the desired program number (eg press 2 times for program 2). After 2 seconds the melody indicates the MI-6 has returned to the search mode.

### Recover a lost MI-6

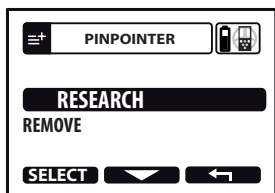

Find your pinpointer within a radius of 25 meters, even if switched off and missing after several weeks.

- 1 Choose , select **PINPOINTER** and **RESEARCH**
- 2 The pinpointer will start sounding with a flashing LED.
- 3 Press the pinpointer button and return to the search mode with

### MI-6 active display screen

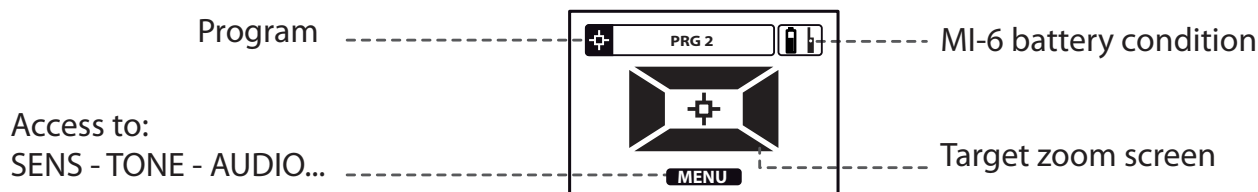

# OPTION

## THE MI-6 - EXTENDED FUNCTIONS

### Sensitivity

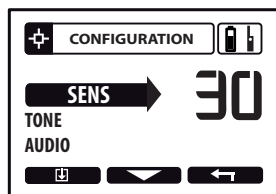

The MI-6 has 50 levels of sensitivity via the remote control.

Press  $\ominus$  or  $\oplus$  To adjust the sensitivity levels via the remote control.

**Note :** For precise object location, low sensitivity levels, such as prog 1 and 2, are recommended. The high sensitivity level (prog 3) is for cache location or searching in walls and furniture.

**Retune** At any time, you can re-calibrate the MI-6 by pressing the button very briefly while away from any metallic source. On mineralised soil and salt water, re-calibrate the MI-6 when in contact with the ground to localize the detection range, also re-calibrate (de-tune) when near to a large object.

### Tone

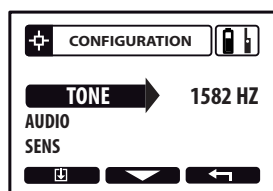

The MI-6 audio PULSE tone can be adjusted from the remote control, tones range from 120 to 1582 Hz. (Audio PULSE mode only)

Press  $\ominus$  or  $\oplus$  to adjust the tone.

**Note :** Tone is available only with the Audio PULSE mode

### Audio PITCH / Audio PULSE

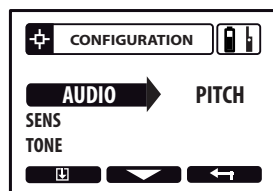

- **Audio PITCH:** The sound varies in tone and intensity, it is the default mode, it offers fast target location.

- **Audio PULSE:** Has a higher sound, intended for noisy environments. Target location is not as precise as PITCH mode. Pitch and Pulse mode both have the same performance.

Press  $\ominus$  or  $\oplus$  to switch from one mode to another.

### Making and saving a custom program

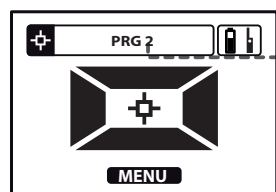

Choose from one of the 3 factory pre-set programs in the menu to make your own custom program which can then be saved as (prg4).

- 1 Select the program you want by pressing  $\ominus$  or  $\oplus$
- 2 Enter the settings by pressing **MENU**
- 3 Save your settings by pressing **SAVE**

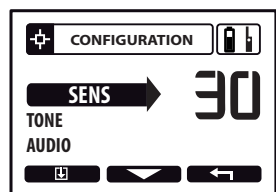

**Note :** When first used the MI-6 will start on program 2. After this it will start on the last used program.

**Note :** The 4 programs on the remote control are separate from the programs inside the pinpointer. When used independently the MI-6 (unpaired) will always use it's factory programs.



# POWER SUPPLY-BATTERIES

## USB CHARGER (not included)



The ORX can be charged using any standard USB 5V certified charger with a minimum capacity of 1A and 5V output. 1A 5V USB charger is enough to charge the 3 elements together (coil/remote/headphone). A computer USB output is also suitable and can charge 1 or 2 elements at a time (eg :coil + remote).

Take care about the quality of the charger and never use unknown or unbranded cheap products. It is important to check that the charger has the correct symbols of certification :



By purchasing this product, the buyer/user agrees that he/she has read and understood the battery & charger safety precautions printed in this document, that he/she bears full responsibilities of these risks, and does not hold Xplorer, or its retailers responsible for any accidents, loss of life, injury to persons, or property damage that may occur as a result of : Incorrect use of the battery including charging with a non-approved or non-certified charger.

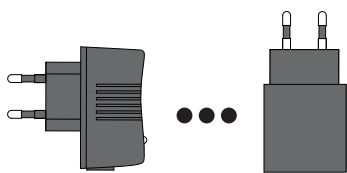

**USB Charger (not included)**  
( Apple™, Samsung™, Sony™, Huawei™ ...)

**Output 5V  $\equiv$  1A or +**



**USB port on laptop**

**Output 5V  $\equiv$  0.5A or +**

- The power adaptor is only designed for indoor use and should not be exposed to water or humidity.
- Always connect your power adaptor in an accessible, visible place to ensure that it can be unplugged quickly in the event of overheating or other problems.
- Do not charge the devices during a thunderstorm, always unplug the power adaptor from the supply.
- Do not charge close to inflammable parts or substances.

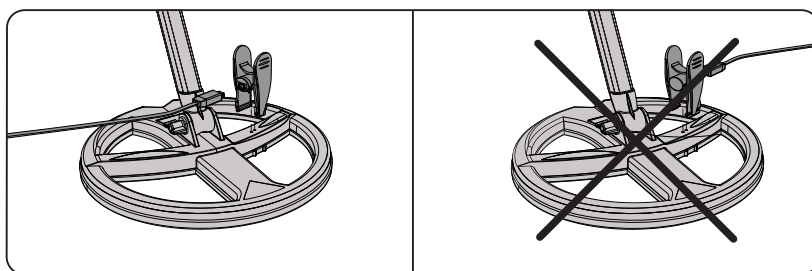
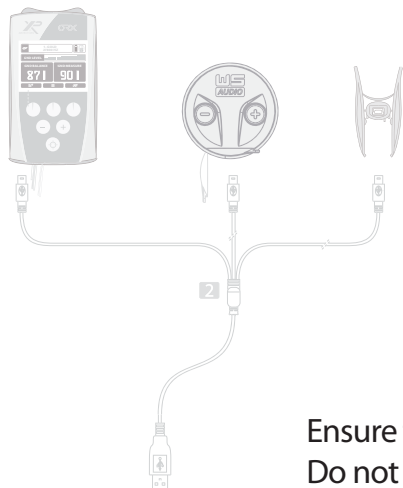



Ensure that the clamp is the right way round before connecting it to the coil. Do not adjust after fitting, it can take up to 10 seconds for the led to activate.

# POWER SUPPLY-BATTERIES

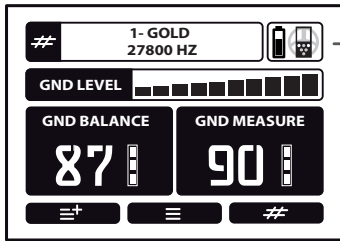
## BATTERY STATUS



The **REMOTE CONTROL** alternately displays:

- The symbol  which indicates the remote control's charge level.
- The symbol  which indicates the coil's charge level.

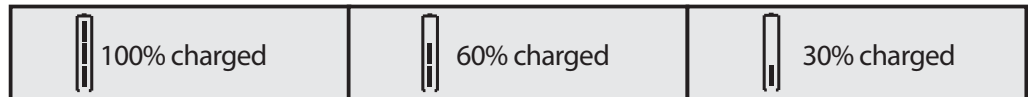

## BATTERY LIFE

<b>WSA:</b> 15 hours	<b>REMOTE CONTROL:</b> 19 hours	<b>COIL :</b> ± 25 hours
----------------------	---------------------------------	--------------------------

The search coil's battery life may vary depending on the modes used. The table below shows battery life according to frequency.

HF COIL	Frequency <b>14</b> kHz	Frequency <b>30</b> kHz	Frequency <b>55</b> kHz	Frequency <b>80</b> kHz
Battery life	20 hours	27 hours	28 hours	28 hours

## CHARGING TIME

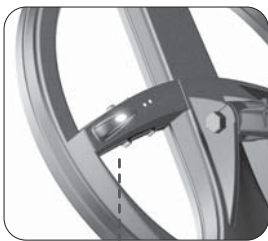

### **COIL - HEADPHONES - REMOTE CONTROL: 3 Hours.**

Lithium batteries do not suffer from the 'memory effect' so you can recharge them at any time without first having to wait for them to fully discharge.

The LED on the coil is on continually when charging is underway. When charging is complete, the LED will alternate **3s ON / 3s OFF**.

## HOW TO EXTEND DURABILITY OF THE LITHIUM BATTERY ?

The LiPo batteries are designed to take hundreds of charges and can last 5 to 10 years in your detector, if used correctly:





- Long term storage of fully discharged batteries or fully charged batteries may reduce their overall durability.
- If you wish to place your machine in storage, first charge the batteries to half of their capacity (40 to 70%) 
- Perform a discharge / charge cycle at least once every two months.

## PRECAUTIONS

Acceptable ambient temperature during charging: from **0°C** to **+ 35°C Maximum**.  
Recommended storage temperature: **25°C**.

# POWER SUPPLY-BATTERIES

## Batteries

-  - The batteries are fitted with internal protection systems which shield them from extreme overloads and discharges. They must not be dismantled or short-circuited, which is dangerous.
- Do not leave batteries charging unnecessarily.
-  - If you notice any perforation, odour or other anomaly, please take the battery to a designated collection point
- Never dispose of lithium batteries with your household waste: depose them at a collection point.
- Do not place the batteries near heat sources and never throw them onto a fire
- Never perforate the battery cover or try and weld/solder the battery.
- Risk off explosion if battery is incorrectly replaced.
- Replacing the battery with an incorrect type can lead to an explosion risk. Only use LiPo batteries
-  - Acceptable ambient temperature during charging: from **0°C** to **+ 35°C Maximum**.
- Recommended storage temperature: **25°C**.
- If you notice an abnormal overheating of the support elements, immediately unplug the power supply and do not attempt to recharge.
-  - Do not travel by air with a defective or questionable battery.

## PRACTICAL INFORMATION

### ADVICE BEFORE BEGINNING DETECTING

Metal detecting is a fascinating leisure activity that can bring you a lot of satisfaction. However, it requires a minimum of learning in order to get the most enjoyment. Begin by familiarising yourself with your equipment and its operation on a suitable practice ground. To do this, we recommend that you take an assortment of different objects: coins, everyday items, metal rubbish, etc. Then find a patch of ground relatively free from metal pollution and far away from any electromagnetic interference (high voltage power lines, electric fences, domestic appliances, etc.). For instance, your garden would probably be one of the most unsuitable places to begin as there is too much domestic waste in the vicinity.

Arrange your objects on the ground then, take some time to observe your device's reactions when it passes over each target.

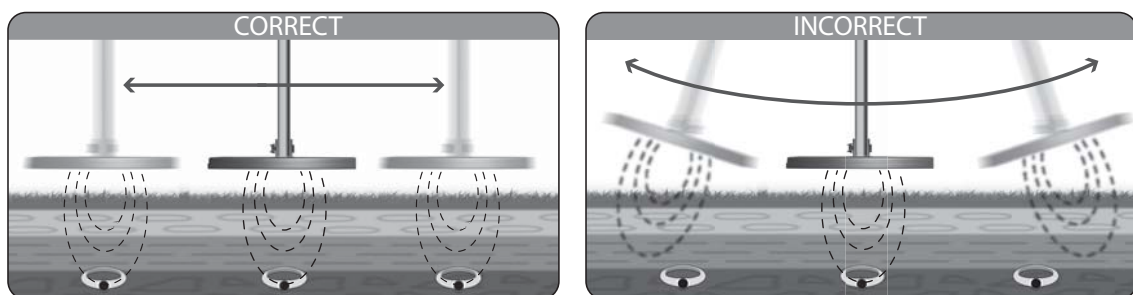

### LOCATING A TARGET USING CROSSED SWEEPS IN MOTION MODE

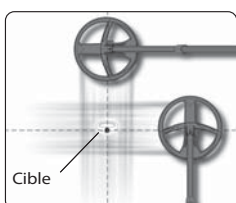

If you are having difficulty locating the target then sweep the place where you heard the sound. Move a quarter turn around the spot and begin sweeping again in the same way. You should then locate the precise zone containing your target at the intersection of the two sweeps where the sound is loudest.

# TROUBLESHOOTING

You become aware of abnormal performance, instability, false signals, interference, for no apparent reason

CAUSES	SOLUTIONS
Sensitivity is too high.	Lower it (pg 05).
You are in a zone with a lot of interference (high-voltage power lines, electric transformer, electric fence).	Lower the sensitivity change frequency/ frequency shift or move to a different zone.
There is a storm nearby and the electromagnetic discharges of lightning are interfering with the detector.	Switch off and wait for the storm to pass
You are close to other working metal detectors.	Change or shift the frequency (pg 05). or move further away.
The ground balance is set too low. Reset it	Adjust it (pg 08).
The ground is heavily infested with iron and other metals.	Find a less infested place. Don't practice in your garden!

The coil does not switch on, unlike the remote control and the headphones

CAUSES	SOLUTIONS
You have a different coil selected in the menu : OPTION / COIL ON the remote control or in the menu COIL on the headphones.	Select the corresponding coil (pg 10).
The serial number of the coil that you had entered in the remote control was incorrect or was changed inadvertently.	Check the coil's serial number (pg 10), paying attention to D & O also B & 8.
The coil battery is discharged	Recharge it.
The coil is defective.	Contact your reseller.

There is no sound in the headphones when passing over a target and pressing the buttons generates no audible beep

CAUSES	SOLUTIONS
The backphone is faulty.	Change it, it is easy to replace (pg 17).
The earpiece is faulty, for example its keypad was poorly reconnected to the circuit after being removed, or the audio contacts are faulty or dirty.	Contact your reseller

# SPARE PARTS

## ORX REMOTE CONTROL ( REF: D08ORX )

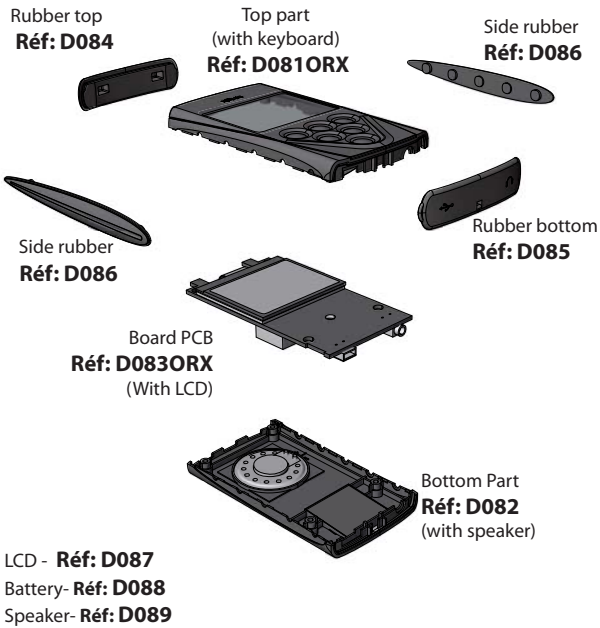

## WS AUDIO (REF: WSAUDIO)



## ORX STEM ( REF: D044LITE ) / COILS / etc...

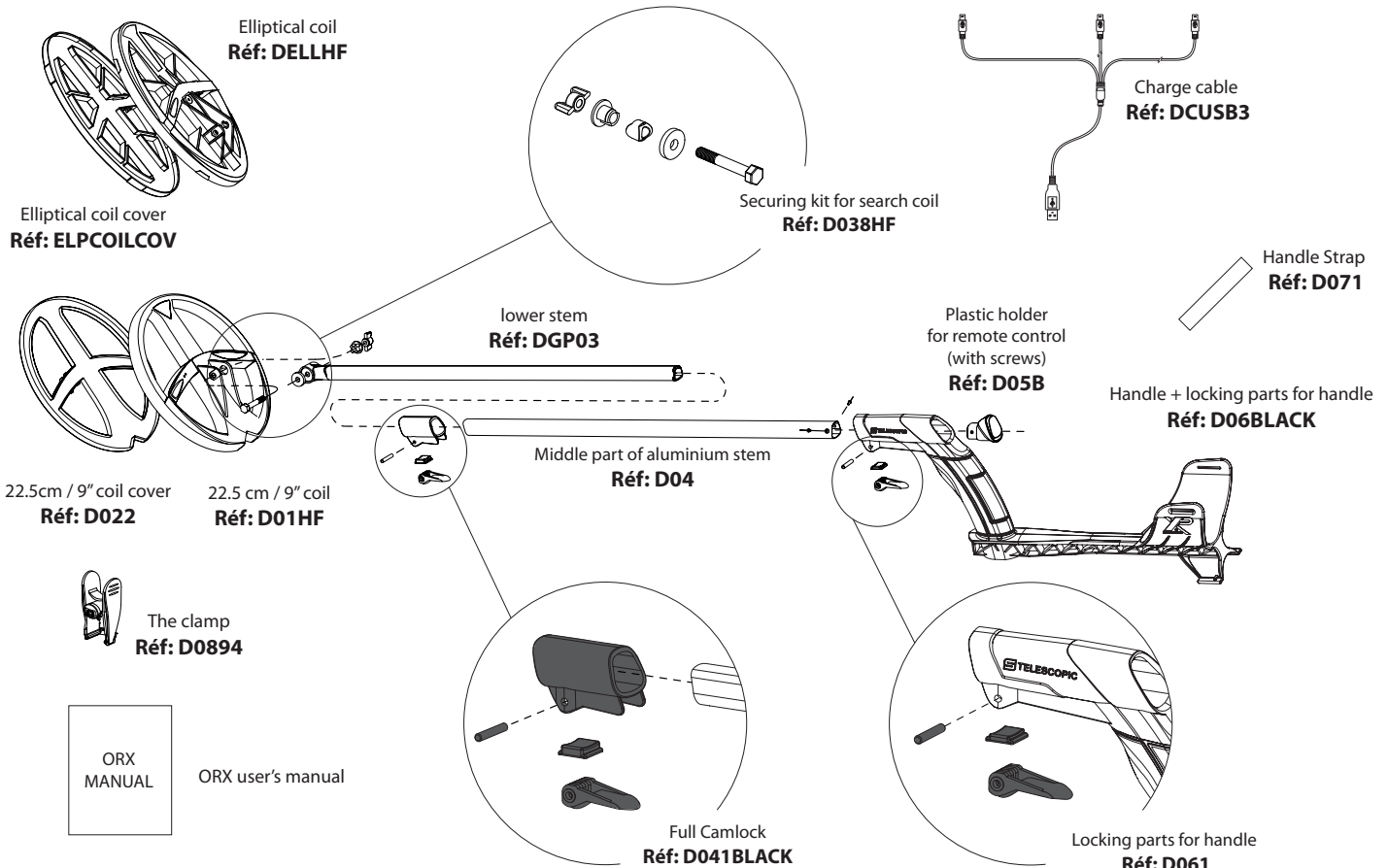



# SPECIFICATIONS

Radio	Link Channels	— Digital wireless
	Radio Frequencies and Radio power	— 36 automatic channels
		— 2.4GHz / ~ 0.56mW
Settings	Detection Frequencies	— 22cm / 9" HF COIL: 15 / 28 / 54 kHz + shift
		— Elliptical HF COIL: 15 / 28 / 80 kHz + shift
		— X35 coil : 4 / 8 / 12 / 18 / 25 kHz + shift
	Sensitivity	— 99 levels
	Reactivity	— 4 levels
	Iron tone	— ON / OFF
	Ground balance	— Automatic mode / Manual mode
	Discrimination	— IAR ( Iron Amplitude Rejection) + Normal
	Target ID	— Audio & visual
	Factory programs	— x 4 + 2 customisable programs
	Audio Volume	— Yes on wired headphones and wireless headphones
General features	Display screen	— 8192 pixels
	Backlighting	— Yes, very low power consumption
	Wireless hgeadphones	— Yes, WS AUDIO in option, rain proof.
	Coil	— DD, waterproof - wireless
	Coil cover	— Yes
	Headphones storage case	— Yes with WSA headphones (optional)
	Stem	— Fully telescopic, S- shape
	Batteries	— Lithium polymer, miniature ⊗
	Battery level indicator	— Yes
	Remote control battery life	— 19 hours
	Wireless WSA battery life	— 15 hours
	Coil life	— 20 to 28 hours
	Mains power charger	— Optional - rapid and simultaneous charging of all elements. Input 100-200V 50/60Hz, Output 5V = 1A
	Field charger	— Optional
	Car charger	— Optional, with 1 AA battery & torch function
	Charging time	— Coils / WSA / Remote control : 3 H
	Total weight with batteries	— 870 g (770g without remote control)
	Total weight of stem	— 390 g
	Weight of remote control with batteries	— 100 g
	Weight of headphones with battery	— 66 g (WSA)
	Weight of coil	— 345 g with coil cover (22cm / 9" Coil)
	Length of folded stem	— 58 cm
	Length of deployed stem	— 130 cm
	Operating T°	— From -5°C to + 40° C
	Max ambient T° during changing	— From 0°C to + 35°C
	Waterproof coil	— Yes, but an optional antenna is required for use when the coil is submerged
	Guarantee	— 5 years parts and labour, battery 2 years.
	Patents	— EP 1990658 B1

## BATTERY SPECIFICATIONS FOR AIR TRANSPORT

TRANSPORTING LITHIUM BATTERIES: Following strict regulations regarding transportation of lithium batteries, some airlines will ask you these specifications:

	Quantity	Type	Power	battery weight
DEUS coil	1	630mA	2.30 watts/hour	13.7 g
HF COIL	1	830mA	3.14 watts/hour	16.3 g
Wireless headphone WSA	1	250mA	0.93 watts/hour	4.9 g
DEUS remote control	1	630mA	2.30 watts/hour	13.7 g

## RECOMMENDATION TO DETECTORISTS / THE LAW

Detecting is an activity which, like other leisure activities, requires a few general guidelines. These recommendations will enable everyone to enjoy their hobby to the full while respecting laws, places, the environment and other people.

- Ensure you are informed of current legislation relating to discovery of treasure in order to abide by the law.
- Declare any fortuitous archaeological discoveries to the local authorities (town hall) of the discovery site within 48 hours.
- Before prospecting on a site, obtain permission from its owner(s) or guardian(s).
- Respect the natural environment in which you are prospecting and any other places to which you need access.
- Systematically back-fill any holes you make so as to leave a site exactly how you found it.
- Keep any rubbish you find in order to dispose of it in a dustbin.

**Avoid detecting in areas where battles are known to have taken place during wartime. Exercise extreme caution with any suspect object resembling munitions, grenades, mines, shells, bombs, etc. and notify the relevant authorities (police, local authorities, etc.) of any such object you find.**

Remember that you are an ambassador for metal detecting and it is important that you convey a positive image!



## DECLARATION OF CONFORMITY EU

This declaration is made under the responsibility of the manufacturer:

XPLORER SARL - 8 rue du Développement - F-31320 CASTANET-TOLOSAN  
We, XPLORER, hereby certify that this detector complies with the essential requirements of European Directives RED 2014/53/EU, SECURITY 2014/35/EU, EMC 2014/30/EU, which aims to harmonise legislation in member states on the use of the radio spectrum, electromagnetic compatibility and electrical safety. Assessment of the device's compliance was carried out in accordance with the essential requirements of this directive and the harmonised standards:

- SECURITY (art 3.1.a) : NF EN 60950-1 :2006 +A1:2013+A2:2014+A11:2009+A12:2012, EN50366:2003 and EN50371:2002
- EMC (art 3.1.b) : ETSI EN 301 489-3 : 2013 v1.6.1 and ETSI EN 301 489-1 : 2011 v1.9.2, EN61326-1:1997 + A1 +A2 +A3, EN55011:2007
- RADIO SPECTRUM (art 3. 2) : EN 300 440-2 V1.4.1, EN 300 440-1 V1.6.1 and AS/NZS 4268:2012
- OTHERS : EN300330-1:V1.5.1

Declaration date : 12 .10. 2018

## CERTIFICATION FCC



This device complies with part 15 of the FCC Rules. Operation is subject to the following two conditions:

- (1) This device may not cause harmful interference, and
- (2) This device must accept any interference received, including interference that may cause undesired operation.

NOTE: The grantee is not responsible for any changes or modifications not expressly approved by the party responsible for compliance. Such modifications could void the user's authority to operate the equipment.

## PRECAUTION FOR USE

ORX is a precision device, designed to be as robust as possible. Despite this, it is important to take care of it and exercise certain precautions in order to prolong its life:

- Do not store your device for long periods with discharged batteries. Ideally you should discharge/recharge the batteries at least once a month, and if possible store them 40 to 70% charged. 
- Do not expose your detector to extreme temperatures, particularly inside a car in full sun.
- Do not expose your detector to the sun without reason when it is not being used.
- When you switch on the detector ensure that the coil is not near any metal objects.
- The remote control of your detector is not waterproof. In wet weather be sure to protect it !
- Use the storage case that is supplied with the headphones and never carry them at the bottom of a bag without protection.
- Use the case that is supplied with the remote control to protect it in adverse conditions, and when the detector is stored away.
- Do not use solvents or alcohol to clean the detector. Soapy water is sufficient.
- Depending on how you use your detector, it may be advisable to clean its elements regularly. A damp cloth can be used to clean the non-waterproof parts (headphones and remote control).
- After use, remove any dirt from the stem's locking mechanisms.
- The equipment must be recharged using a SELV LPS power supply



## CERTIFICATION IC



This device contains licence-exempt transmitter(s)/receiver(s) that comply with Innovation, Science and Economic Development Canada's licence-exempt RSS(s). Operation is subject to the following two conditions:

- (1) This device may not cause interference.
- (2) This device must accept any interference, including interference that may cause undesired operation of the device.

L'émetteur/récepteur exempt de licence contenu dans le présent appareil est conforme aux CNR d'Innovation, Sciences et Développement économique Canada applicables aux appareils radio exempts de licence. L'exploitation est autorisée aux deux conditions suivantes :

- 1) L'appareil ne doit pas produire de brouillage;
- 2) L'appareil doit accepter tout brouillage radioélectrique subi, même si le brouillage est susceptible d'en compromettre le fonctionnement.

## Safety relating to electromagnetic radio waves

This product complies with standards for user safety with regard to electromagnetic waves. The strength of the radio signals used is considerably weaker and on a much smaller scale than those emitted by mobile telephones (2,000 to 4,000 times weaker), as well as being much less than those used by Wi-Fi systems. Moreover, when the complete system is used, the audio headphones only act as a passive radio receiver.

**WARNING:** The accessories delivered with these detectors may vary, and similarly the menus and certain features described in this manual may differ slightly from the product purchased.

This detector is not suitable for applications involving the search for dangerous targets such as munitions, mines, etc.

## Recycling of electrical waste in european union and other countries



If this symbol is displayed on the product or its packaging, it means that the product must not be disposed of with your household waste. You must take it to a designated collection point for recycling electrical and electronic waste. This selective waste sorting and recycling helps to preserve natural resources and avoid any potential risks for human

health and the environment that could result from inappropriate scrapping, due to the possible presence of dangerous substances in the electric and electronic equipment. For more information on places where you can take your electrical waste, please contact the shop where you purchased this product. Alternatively you can return it to your supplier, or directly to XP. The same is true for the lithium batteries which must be recycled appropriately, or returned to your supplier or directly to XP.

© 2018 Xplorer sarl

This document contains information that is protected by existing legislation on copyright, brands and royalties. Any reproduction, even partial, of this document, the logos or the XP and Dêus brands is prohibited without the agreement of:

XPLORER SARL - 8 rue du Développement - 31320 - CASTANET-TOLOSAN - FRANCE

## ORX - 5 YEARS LIMITED WARRANTY

This detector has a 5 year parts and labour warranty.

This warranty does not cover:

- Breakage caused by falls, impacts or accidental damage
- Damage caused by abnormal use or resulting from non-compliance with the conditions of use stipulated in the device's instructions
- Alteration of the electronic circuit by any unauthorized person.
- Corrosion of electronic circuits, due to water ingress
- A reduction in battery life due to battery ageing.
- Breakage of cables or wires

Parts that are subject to normal wear and tear like:

- headphones earpads, coil bolts & fittings, cases are not covered by the 5 year warranty.

In the event of any fault or malfunction please contact your XP dealer for advice, should any part require returning to them or the distributor it must be accompanied by a note explaining the fault, carriage/shipping cost is the customer's responsibility. Proof of Purchase is required to make a claim under this warranty. If a faulty device has been replaced by a new or reconditioned one, the warranty will continue from the original purchase date.

Xplorer reserves the right to modify its detectors' characteristics or specifications without notice.

# ACCESSORIES



Coil X35  
22.5 cm - 9"



Coil X35  
28 cm - 11"



Coil X35  
34 x 28 cm - 13"x11"



HF Coil  
22.5 cm - 9"



HF coil elliptical  
24 x 13 cm - 10"x 5"



Pinpointer MI-6



Pinpointer MI-4



MI-4 / MI-6 Stem support  
(Fin 2018)



Kits: Waterproof armband 5m  
+ aerial antenna  
(available in 1m15 or 2m50)

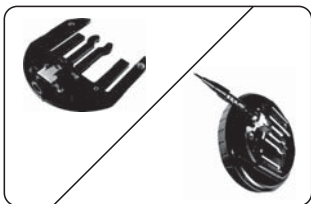

WS4 Clip jack adaptor  
Connect your own  
headphone



FX-02



Hipmount case



Protective silicone case



Armband case



S - TELESCOPIC LITE



S-TELESCOPIC



Car charger



Emergency charger with  
torch function (AA battery  
x1 not provided)



Solar charger



XP case

# FACTORY PROGRAMS

MENU	SETTINGS	1# GOLD For low / average mineralisation, good sensitivity to medium and large sized Gold	2# FINE GOLD For heavy mineralisation / with good sensitivity to small and medium sized Gold	3# COIN FAST For coins and all types of targets good performance on mineralised or contaminated ground.	4# COIN DEEP For coins and all types of targets good performance on low mineralised / uncontaminated ground.	5# -----	6# -----
DISCRI IAR	0 to 5	0 (PITCH)	0 (PITCH)				
DISCRI	0 to 99			7 (3 tones)	7 (3 tones)		
SENSITIVITY	0 to 99	95	90	90	90		
FREQUENCY & FREQUENCY SHIFT							
- 22 HF COIL	13 to 59 kHz	31.3K	54.0K	14.4K	14.4K		
- ELLIPTICAL HF COIL	13 to 80kHz	31.3K	74.0K	14.4K	14.4K		
- X35 COIL	3.7 to 28kHz	17.3K	25.4K	17.3K	7.7K		
IRON TONE	ON / OFF	ON	ON	ON	ON		
REACTIVITY	1 / 2 / 2.5 / 3	2	2.5	3	2		
THRESHOLD	0 to 20	0	0	0	0		
GROUND (manual or auto)	00-30 (SALT) 60-95 (NORMAL)	87	87	88	88		
SALT MODE	ON / OFF	OFF	OFF	OFF	OFF		





# ORX QUICK START

# 1



1 Switch on the remote (to switch off press for 2 sec)



Validate or not the use of the loudspeaker



Wait a few seconds

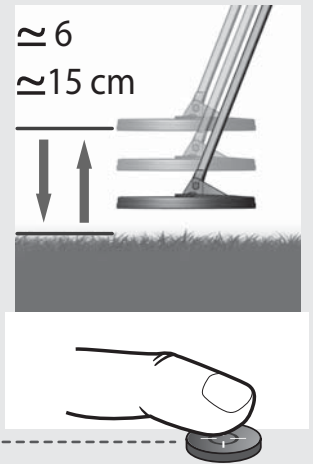

Press once to grab the ground value while pumping the coil to the ground in order to calibrate the ground effects.

**Restart the operation if the ground changes or value becomes unstable.**

# 2

Pairing the WSA to the remote control (page 10)

Press to switch ON the WSA

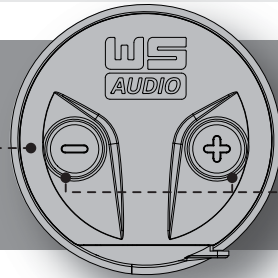

Change the audio volume with or

Press and to switch OFF the WSA

\*Note : The WSA will turn OFF automatically with the remote

# 3

By default factory program **1 - GOLD** is selected

Press if you wish to select one of the 4 factory programs (+ 2 customisable programs).

# 4

Adjust the **Sensitivity** to stabilise the detector :

1 Press to access the different features

2 Scroll through functions until SENSITIVITY

3 Press to adjust the sensitivity

4 Exit with

# 5

