

POWERFAN[™]

PF20 Inspection & Maintenance Manual

Version 1.2 (February 2013)

For assistance contact Dropzone.

POWERFAN® is a trading name of **Dropzone (UK) Ltd**, Lasham Woods, Lasham, Alton, GU34 5FZ, UK
t: +441256 381 222 f: +44 870 130 7560 e: info@drop-zone.eu w: www.powerfan.co.uk

Contents

1. Warning	3
2. Terminology	
Figure 1: POWERFAN® PF20 and Drope™	4
Figure 2: POWERFAN® PF20 with belt guard retracted	5
Figure 3: POWERFAN® general mounting arrangement	6
3. Getting started	
3.1 Preparing your POWERFAN® for use	7
4. Inspection and Maintenance Schedule	
4.1 Preparing your POWERFAN® PF20 for use	10
4.2 Factory service	11
4.3 When to retire a Drope™	11
4.4 When to retire the rewind springs	12
5. Drope™ Replacement	
5.1 Removing a used Drope™	14
5.2 Preparation of a new Drope™	19
5.3 Fitting a new Drope™	22
6. Spring Replacement	
6.1 Removing used rewind springs	27
6.2 Fitting new rewind springs	36
7. Powerfan Installation	
7.1 General mounting arrangement	41
7.2 Mounting types	42

For assistance contact Dropzone.

POWERFAN® is a trading name of **Dropzone (UK) Ltd**, Lasham Woods, Lasham, Alton, GU34 5FZ, UK
t: +441256 381 222 f: +44 870 130 7560 e: info@drop-zone.eu w: www.powerfan.co.uk

1. Warning

Warning: Failure to adhere to the following instructions is likely to result in very serious injury or death and will invalidate any guarantee. These procedures should only be carried out by a competent person.

Assistance with any of the material contained within this manual may be obtained by contacting Dropzone at:

Dropzone (UK) Ltd
Lasham Woods
Lasham Road
Alton
GU34 5FZ
United Kingdom

Tel: +44 1256 381 222
info@drop-zone.eu
www.powerfan.co.uk

When operated correctly the POWERFAN® will provide years of safe use. These guidelines must be used in conjunction with the *Powerfan PF30 Installation Specification* and the *POWERFAN® Operating Manual*.

For assistance contact Dropzone.

POWERFAN® is a trading name of **Dropzone (UK) Ltd**, Lasham Woods, Lasham, Alton, GU34 5FZ, UK
t: +441256 381 222 f: +44 870 130 7560 e: info@drop-zone.eu w: www.powerfan.co.uk

2. Terminology

Figure 1: POWERFAN® PF20 with Drope™

1. Powerfan PF20
2. Drope
3. Maillon
4. Shock absorbing lanyard
5. User attachment point
(Karabiner)

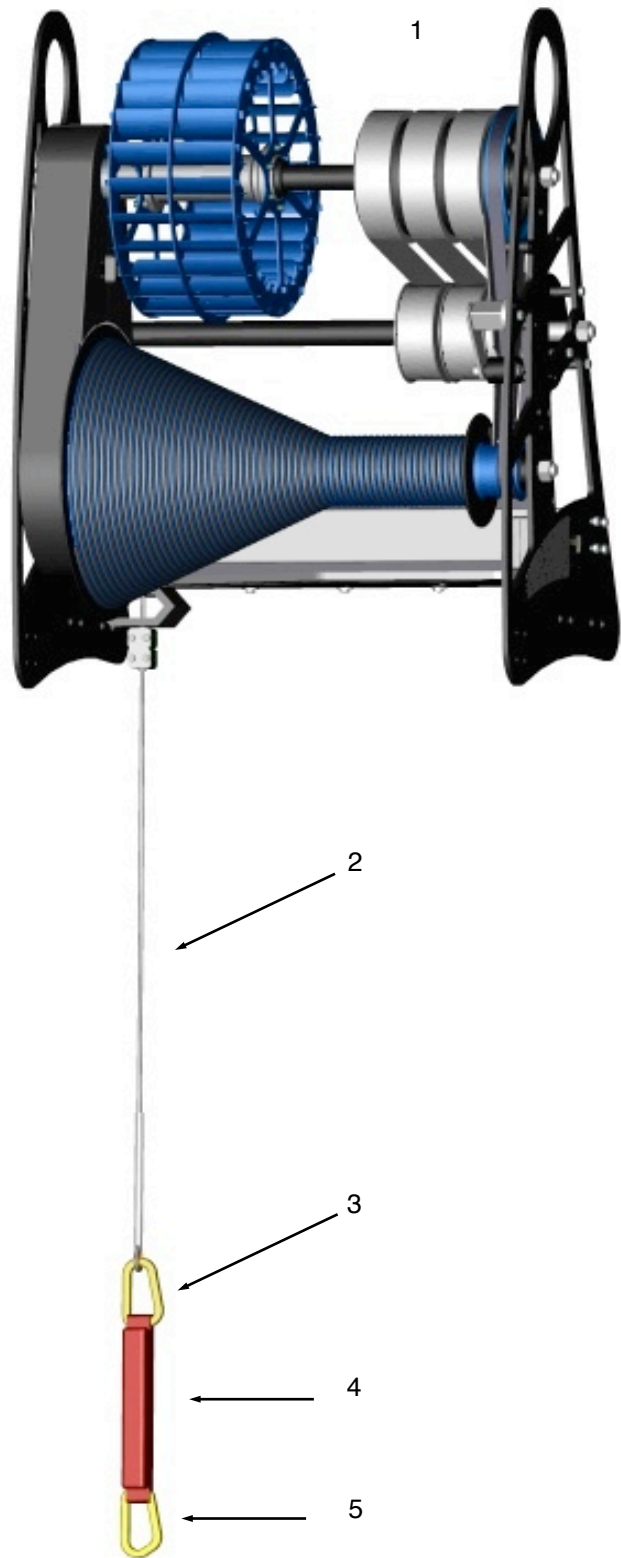

For assistance contact Dropzone.

POWERFAN® is a trading name of **Dropzone (UK) Ltd**, Lasham Woods, Lasham, Alton, GU34 5FZ, UK
t: +441256 381 222 f: +44 870 130 7560 e: info@drop-zone.eu w: www.powerfan.co.uk

Figure 2: POWERFAN® PF20 with belt guard retracted

- | | |
|------------------------|----------------------------|
| 1. Upper spring drum | 9. Small flange |
| 2. Upper rewind pulley | 10. Rope drum |
| 3. Rewind springs | 11. Lower guide plate |
| 4. Rewind belt | 12. Rubber stop block |
| 5. Tensioner | 13. Drope clamp assembly |
| 6. Lower rewind pulley | 14. Retractable belt guard |
| 7. Side plate | 15. Drive belts |
| 8. Descent counter | 16. Flexible draw latch |

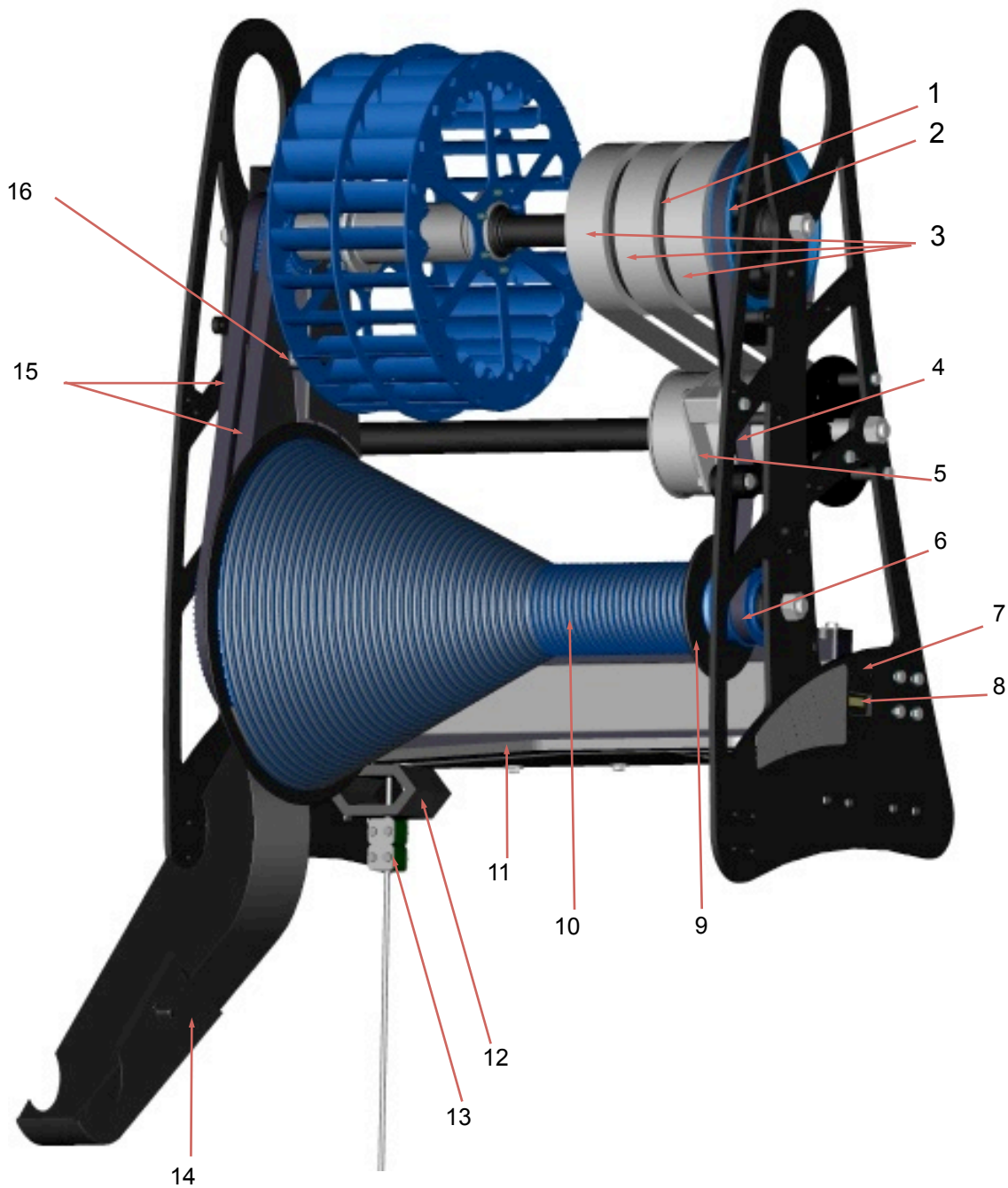

For assistance contact Dropzone.

POWERFAN® is a trading name of **Dropzone (UK) Ltd**, Lasham Woods, Lasham, Alton, GU34 5FZ, UK
t: +441256 381 222 f: +44 870 130 7560 e: info@drop-zone.eu w: www.powerfan.co.uk

Figure 3: POWERFAN® general mounting arrangement

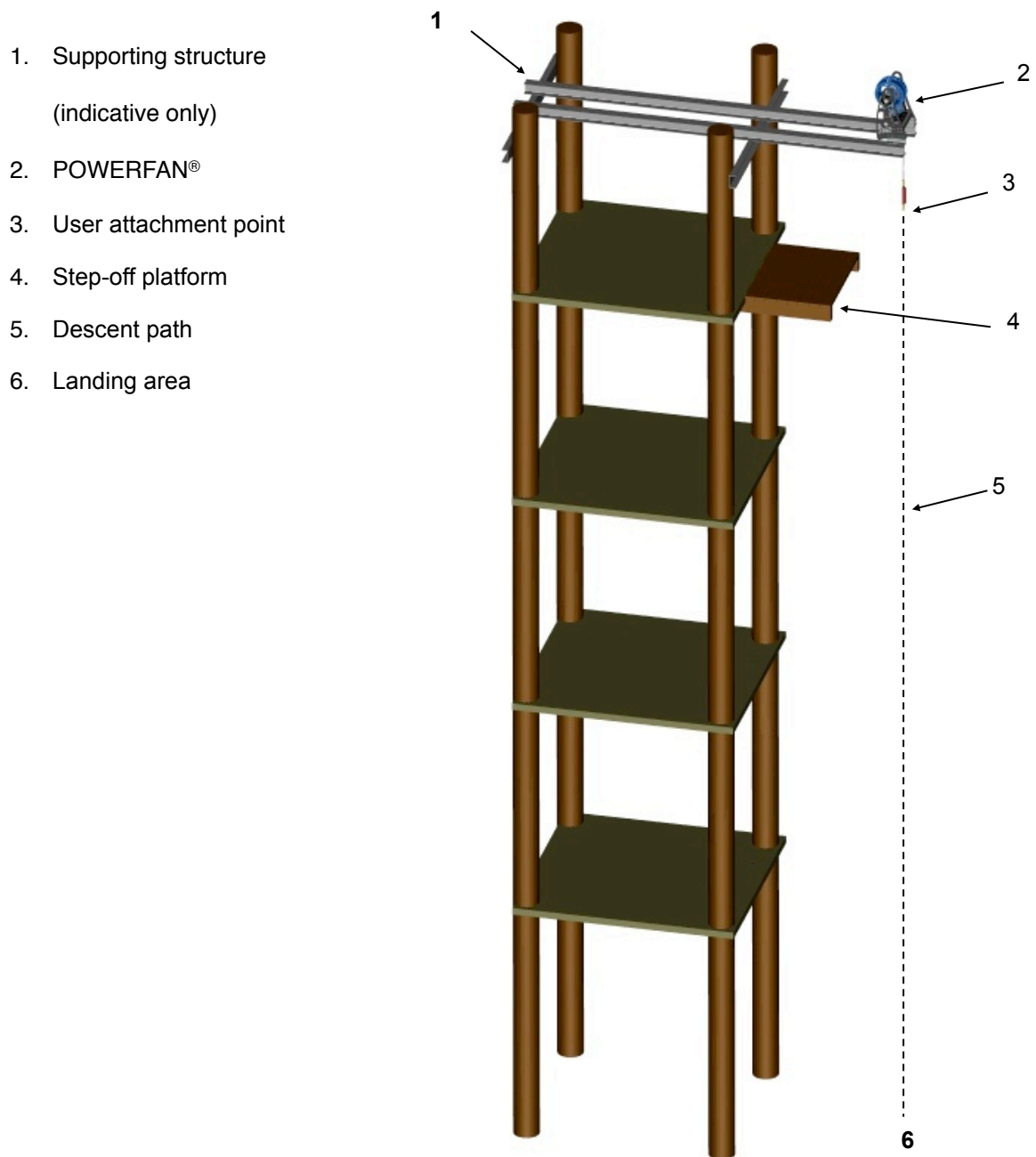

For assistance contact Dropzone.

POWERFAN® is a trading name of **Dropzone (UK) Ltd**, Lasham Woods, Lasham, Alton, GU34 5FZ, UK
t: +441256 381 222 f: +44 870 130 7560 e: info@drop-zone.eu w: www.powerfan.co.uk

3. Getting Started

3.1 Preparing your POWERFAN® PF20 for use

On taking delivery of your POWERFAN® you will have received a package including the following items:

1. POWERFAN® PF20
2. Stop screw
3. Drope™
4. Shock absorbing lanyard
5. Maillon
6. Karabiner
7. Three rubber stop blocks
8. Clamp assembly, including rubber hose and cable ties
9. Three rewind springs (already fitted on the POWERFAN®)
10. *POWERFAN® Operating Manual, POWERFAN® PF20 Inspection and Maintenance Manual.*

Please check that all the above items are present. Should anything be missing, you will not be able to set up your POWERFAN® for safe use.

The sequence of instructions set out below describes the initial setup of the POWERFAN® in preparation for first use. Note that this procedure refers to other, more detailed procedures that can be found elsewhere in this manual.

Step 1

Remove the POWERFAN® from its crate.

This crate should be stored carefully and used again should it be necessary to transport the POWERFAN® at a future date, for example for the two yearly service carried out by Dropzone.

Step 2

Mount the POWERFAN® on a supporting structure according to the instructions in the *POWERFAN® Installation Specification*.

For assistance contact Dropzone.

Step 3

On first receiving your POWERFAN® the rewind belt will not be fitted to the upper or lower rewind pulleys and the rewind spring will be in the position shown in figure 4.

Fit the rewind belt to the upper and lower rewind pulleys and tension the rewind belt. Further details of this procedure are given in steps 5 & 6 found in section 5.3.

Wind one complete turn of the springs onto the upper spring drum by manually turning the fan, as described in step 3 found in section 6.2.

Insert the stop screw to lock the upper spring drum into position. Further details of this procedure are given in step 2 found in section 5.1.

Before proceeding to fit the Drope™, release the rewind belt from the tensioner and remove the rewind belt from the lower rewind pulley.

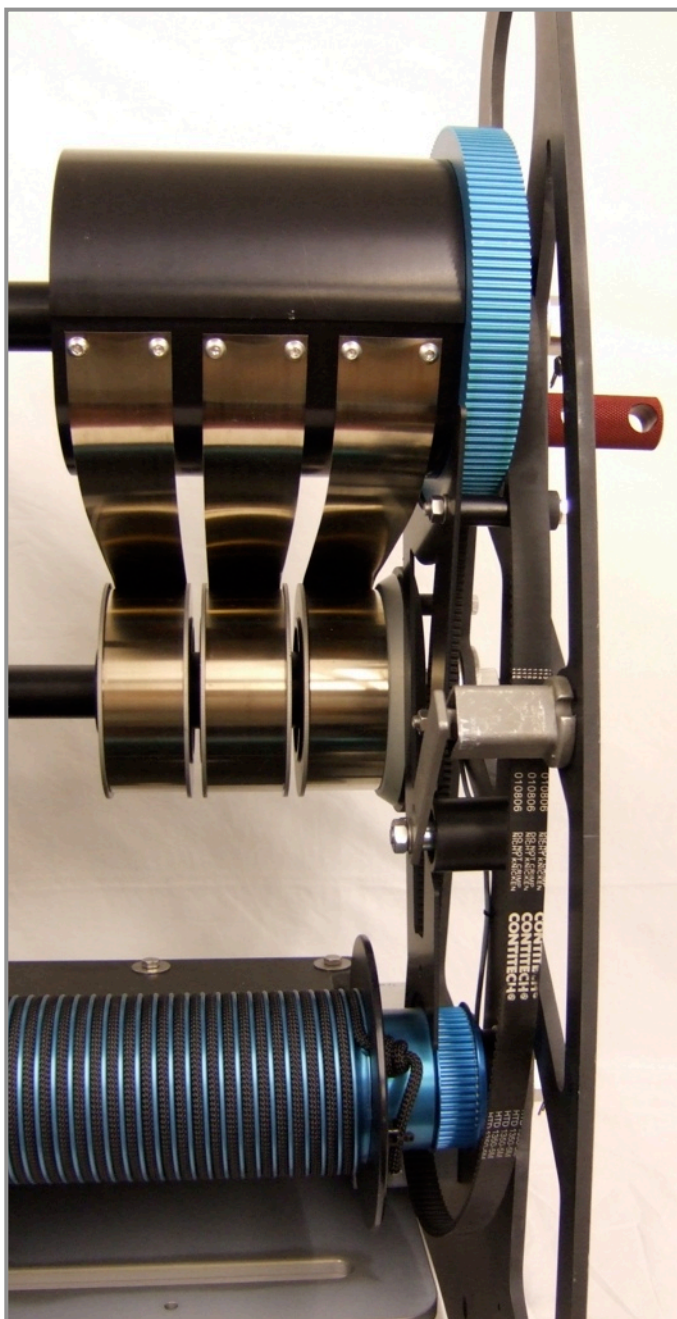

Figure 4

For assistance contact Dropzone.

POWERFAN® is a trading name of **Dropzone (UK) Ltd**, Lasham Woods, Lasham, Alton, GU34 5FZ, UK
t: +441256 381 222 f: +44 870 130 7560 e: info@drop-zone.eu w: www.powerfan.co.uk

The POWERFAN® should now appear as in figure 5 opposite, with one complete turn of the springs on the upper spring drum, the rewind belt released from the tensioner and removed from the lower rewind pulley and the upper spring drum locked off with the stop screw.

Step 4

Prepare the Drope™ according to the instructions in section 5.2.

Step 5

Fit the Drope™ to the rope drum according to the instructions in section 5.4.

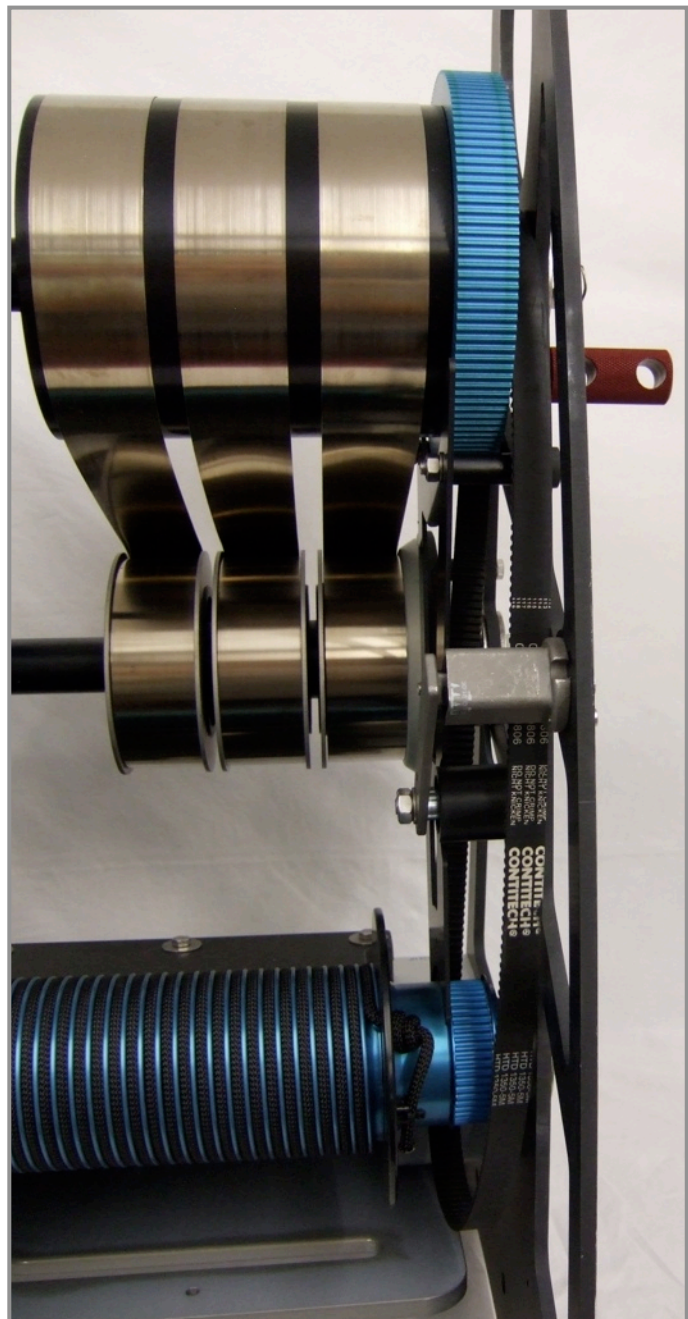

Figure 5

End of POWERFAN® setup instructions.

For assistance contact Dropzone.

POWERFAN® is a trading name of **Dropzone (UK) Ltd**, Lasham Woods, Lasham, Alton, GU34 5FZ, UK
t: +441256 381 222 f: +44 870 130 7560 e: info@drop-zone.eu w: www.powerfan.co.uk

4. Inspection and Maintenance Schedule

4.1 Preparing your POWERFAN® PF20 for use

Before use each day the POWERFAN® must be inspected as follows:

Before starting make a note of the counter number.

Conduct a visual inspection of the Drope™ by slowly unreeling the Drope™ off the rope drum as far as it will go, whilst subjecting the Drope™ to a careful visual inspection. Note that it is important to inspect that part of the Drope™ that lies in the vicinity of the small flange as this can be a wear site. Refer to section 4.3 to determine whether or not the Drope™ must be retired.

Conduct a visual inspection of the rewind springs. This is done by reeling the Drope™ off the rope drum as described in the preceding paragraph. At no stage should it be necessary to touch the rewind springs. It is important that you do not attempt to pull the springs off the spring drums by hand. Refer to section 4.4 in order to determine whether a spring must be retired. Note that the springs must be inspected over their full working length. This corresponds to that portion of the springs that are revealed during the Drope™ inspection process above.

After performing the inspections of the Drope™ and the springs, recheck the counter number. The counter number should have increased by one for each time the Drope™ was reeled off the drum fully during the previous inspections. If this is not the case then the counter is not functioning. It is important that the counter functions properly as it is used to determine service and replacement intervals.

In addition to the inspection of the Drope™ and springs as described above, the operator of the POWERFAN® must also inspect the machine on a daily basis for any of the following defects:

- any signs of damage or excessive wear to the drive belts
- foreign objects or debris anywhere in or on the POWERFAN®
- ice or snow anywhere in or on the POWERFAN®
- loose bolts, screws or nuts anywhere on the POWERFAN®
- any signs of excessive corrosion or cracking anywhere on the POWERFAN®
- any signs of damage or deformation anywhere on the POWERFAN®.

When inspecting the machine the belt guard should be retracted to properly inspect the timing belts and pulleys linking the rope drum with the fan:

1. Undo the flexible draw latch by pulling the handle and lifting it up (figure 6).
2. Pull back the retractable half of the belt guard (figure 7).
3. The timing belts and pulleys can be inspected while the belt guard hangs freely (figure 8).

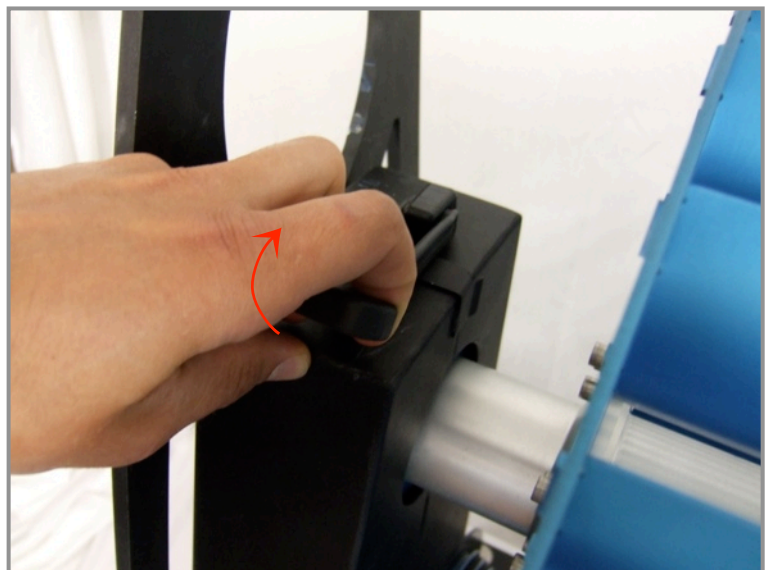

Figure 6

For assistance contact Dropzone.

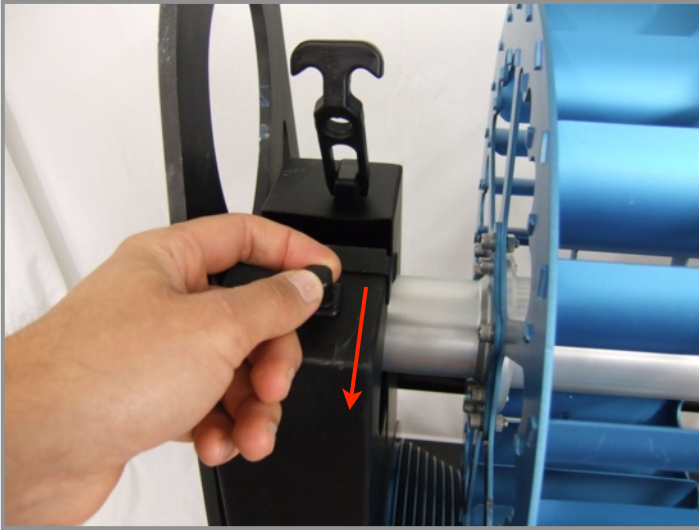

Figure 7

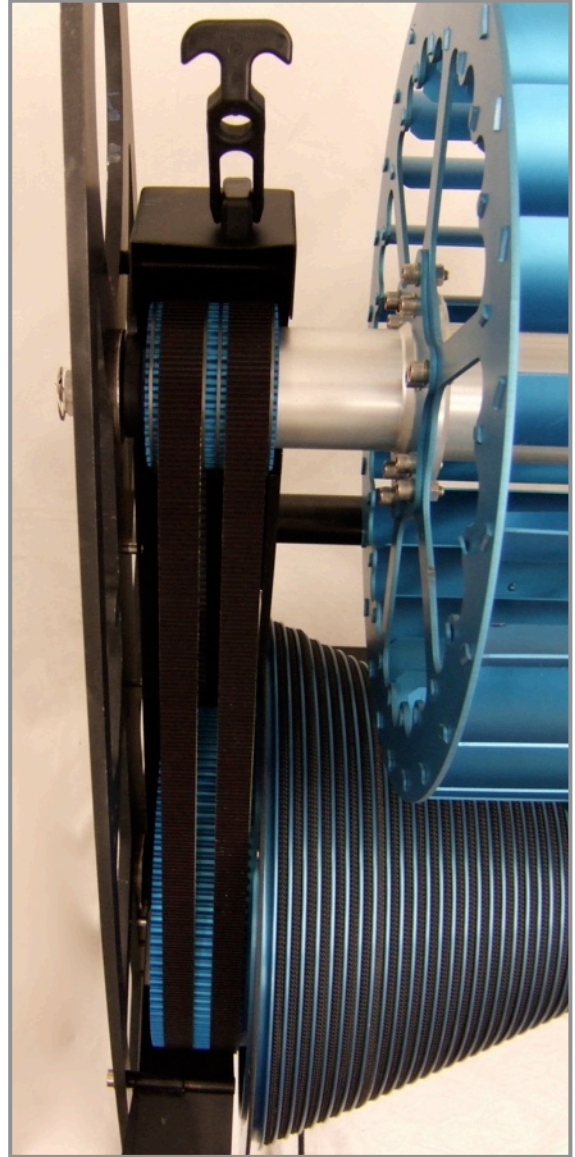

Figure 8

4.2 Factory service

Your POWERFAN® should be returned to Dropzone for a detailed inspection and service after every two years or after every 250,000 descents, whichever occurs soonest.

4.3 When to retire a Drope™

The Drope™ should be retired

- either after a maximum of 20,000 descents have been made since the Drope™ was installed,
 - or after 1 year has elapsed since the Drope™ was installed,
 - or after the sheath of the Drope™ has worn to the extent that the core is exposed,
- whichever occurs soonest.

For assistance contact Dropzone.

POWERFAN® is a trading name of **Dropzone (UK) Ltd**, Lasham Woods, Lasham, Alton, GU34 5FZ, UK
t: +441256 381 222 f: +44 870 130 7560 e: info@drop-zone.eu w: www.powerfan.co.uk

4.4 When to retire the rewind springs

The rewind springs should be retired:

- either after a maximum of 17,000 descents have been made since the springs were installed,
- or after 1 year has elapsed since the springs were installed,
- or after the first signs of spring fatigue have been detected during visual inspection (see figures 9 to 12 on the following pages),

whichever occurs soonest.



Figure 9. New spring showing absence of any defects visible to naked eye.

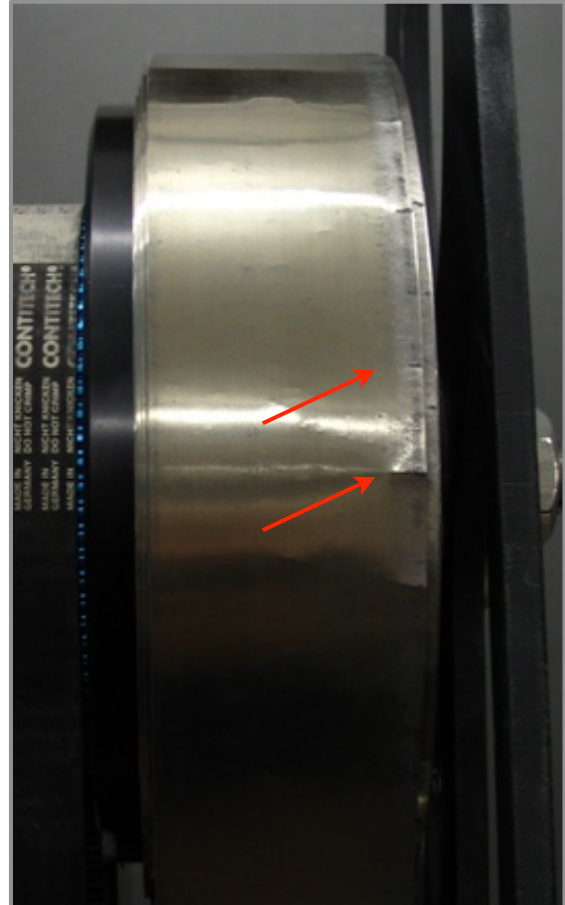

Figure 10. Used spring with clearly visible cracking. This spring should be retired immediately.

For assistance contact Dropzone.

POWERFAN® is a trading name of **Dropzone (UK) Ltd**, Lasham Woods, Lasham, Alton, GU34 5FZ, UK
t: +441256 381 222 f: +44 870 130 7560 e: info@drop-zone.eu w: www.powerfan.co.uk



Figure 11. New spring

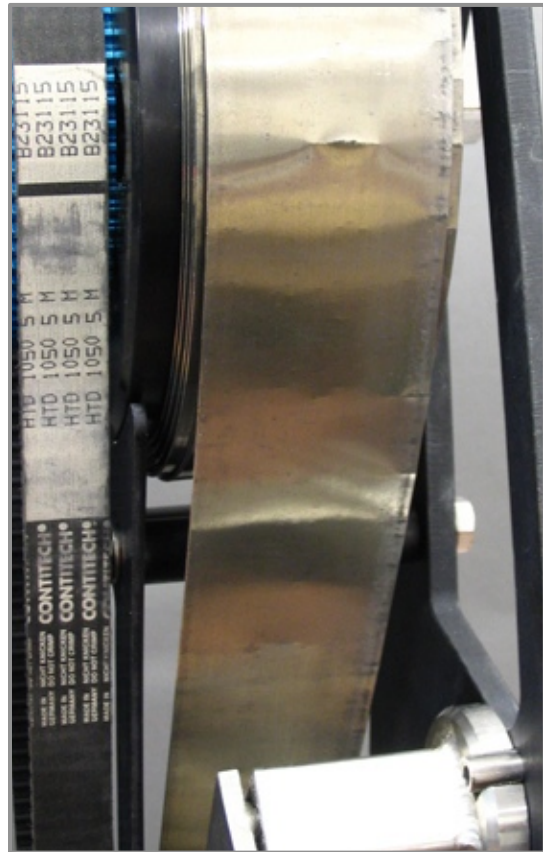

Figure 12. Used spring with clearly visible cracking. This spring should be retired immediately.

For assistance contact Dropzone.

POWERFAN® is a trading name of **Dropzone (UK) Ltd**, Lasham Woods, Lasham, Alton, GU34 5FZ, UK
t: +441256 381 222 f: +44 870 130 7560 e: info@drop-zone.eu w: www.powerfan.co.uk

5. Drope™ Replacement

Drope™ replacement should be recorded in the maintenance and inspection log book. Dropes™ must only be obtained from Dropzone or an authorised Powerfan distributor.

5.1 Removing a used Drope™

Step 1

Allow the spring rewind to rewind the Drope™ fully so that the rubber stop block comes into contact with the lower guide plate.



Figure 13

For assistance contact Dropzone.

POWERFAN® is a trading name of **Dropzone (UK) Ltd**, Lasham Woods, Lasham, Alton, GU34 5FZ, UK
t: +441256 381 222 f: +44 870 130 7560 e: info@drop-zone.eu w: www.powerfan.co.uk

Step 2

Insert the stop screw into the threaded hole in the side plate in order to lock off the upper spring drum.

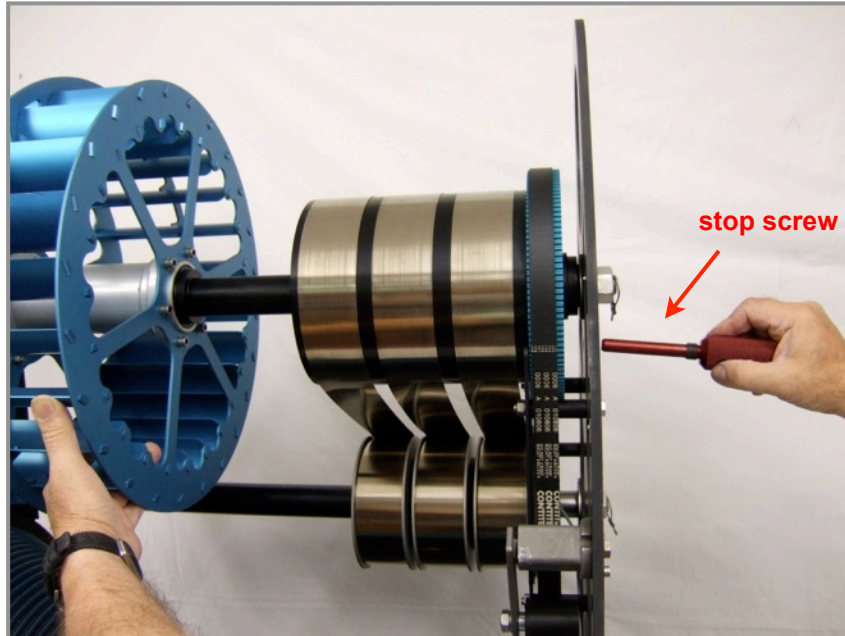

Figure 14

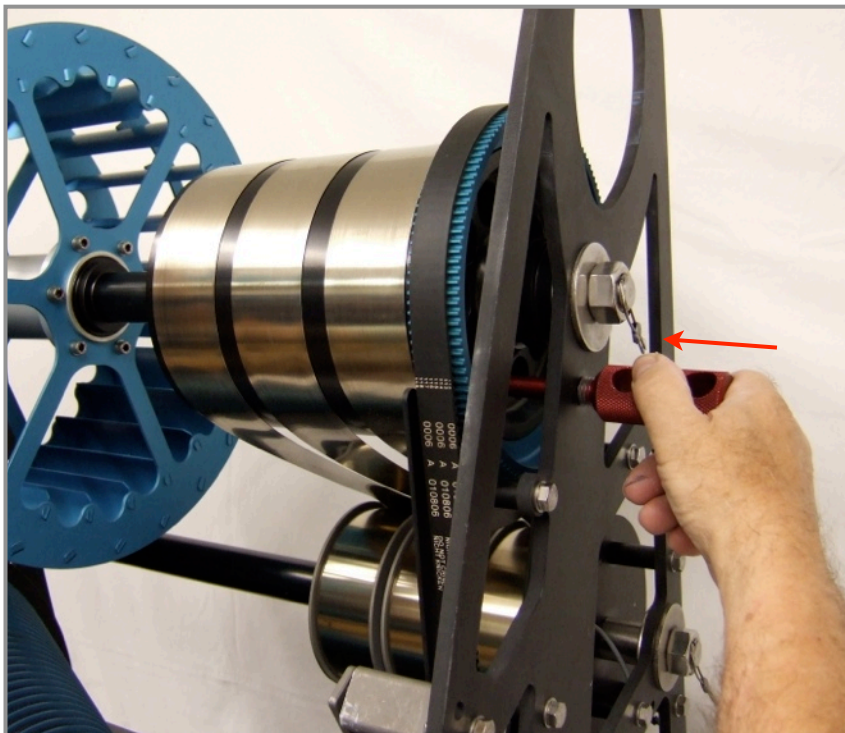

Figure 15

For assistance contact Dropzone.

POWERFAN® is a trading name of **Dropzone (UK) Ltd**, Lasham Woods, Lasham, Alton, GU34 5FZ, UK
t: +441256 381 222 f: +44 870 130 7560 e: info@drop-zone.eu w: www.powerfan.co.uk

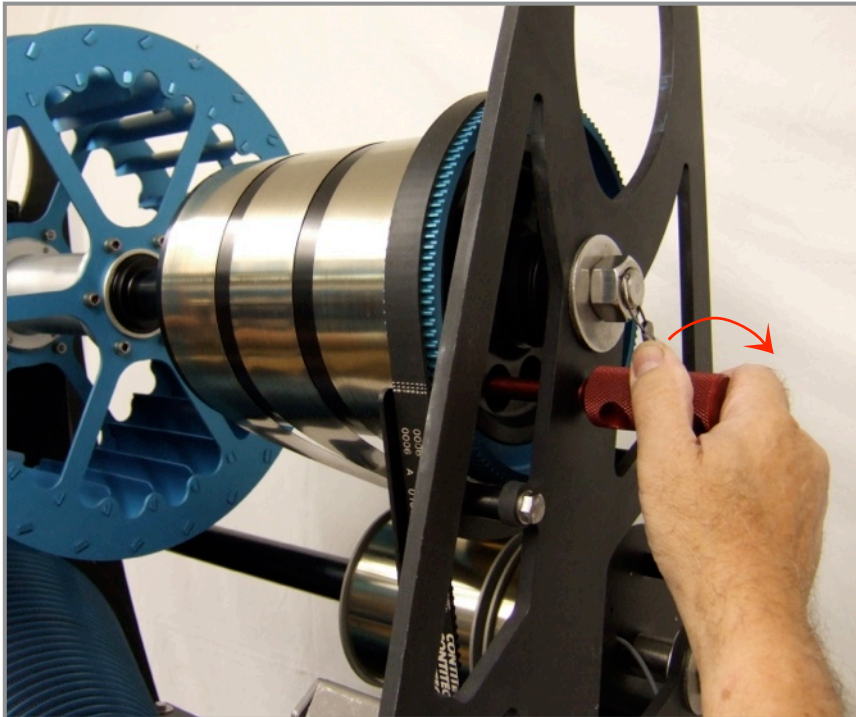

Figure 16

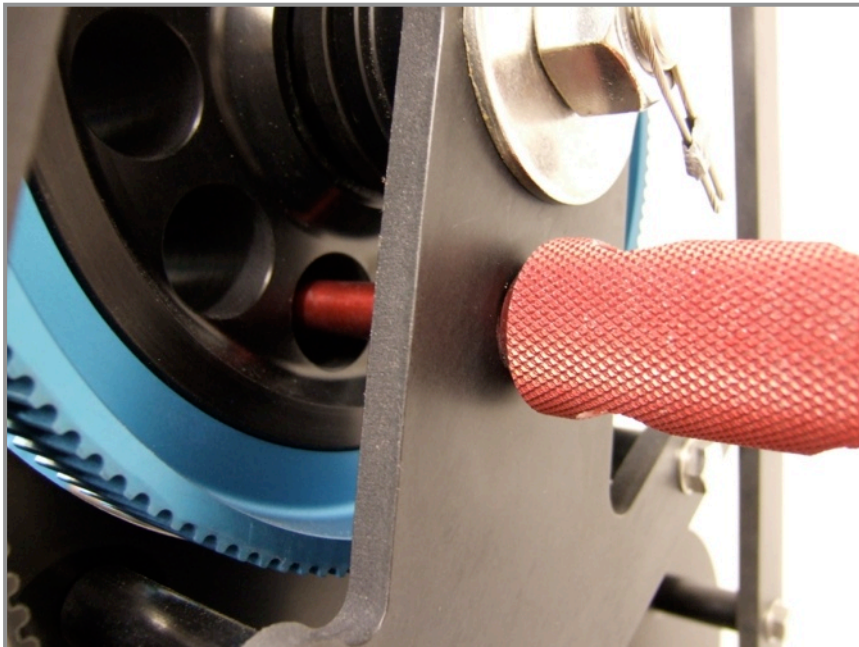

Figure 17

For assistance contact Dropzone.

POWERFAN® is a trading name of **Dropzone (UK) Ltd**, Lasham Woods, Lasham, Alton, GU34 5FZ, UK
t: +441256 381 222 f: +44 870 130 7560 e: info@drop-zone.eu w: www.powerfan.co.uk

Step 3

Isolate the rewind springs by releasing the tensioner from the rewind belt and by removing the rewind belt from the rewind pulleys.

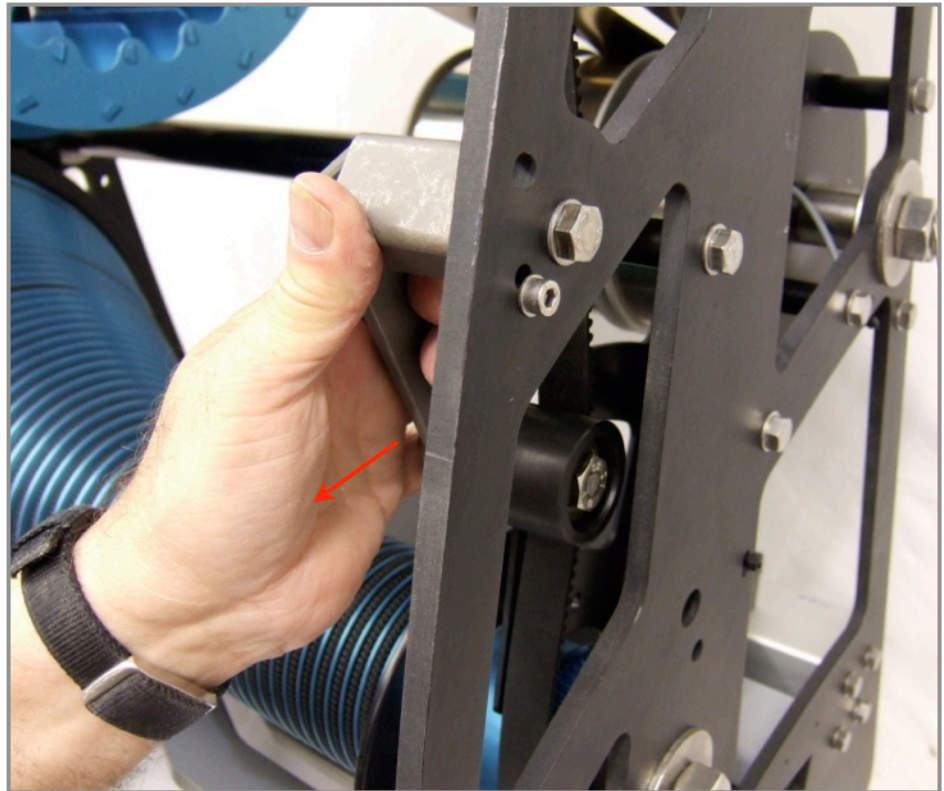

Figure 18

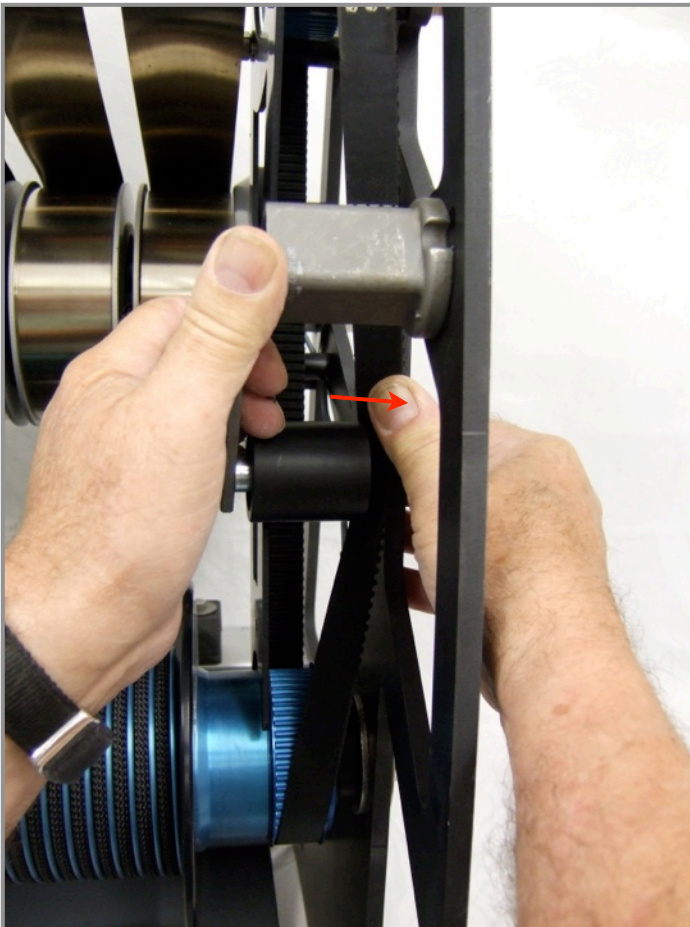

Figure 19

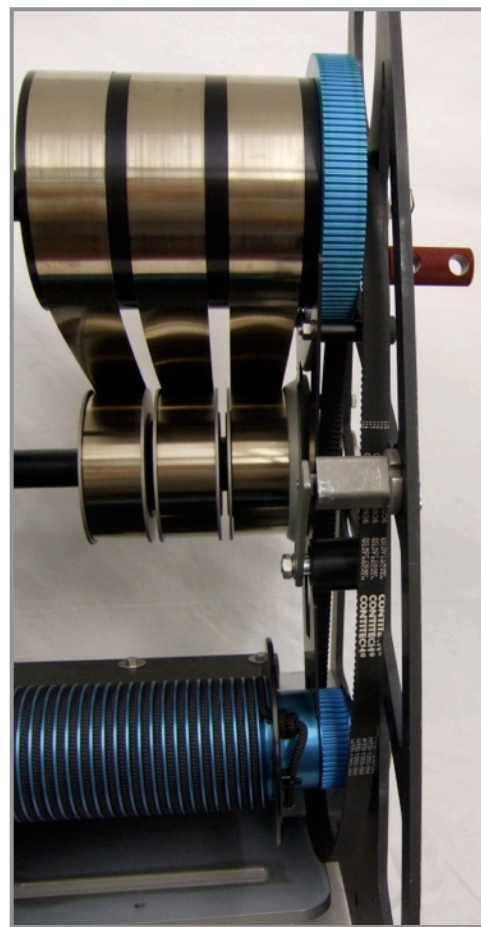
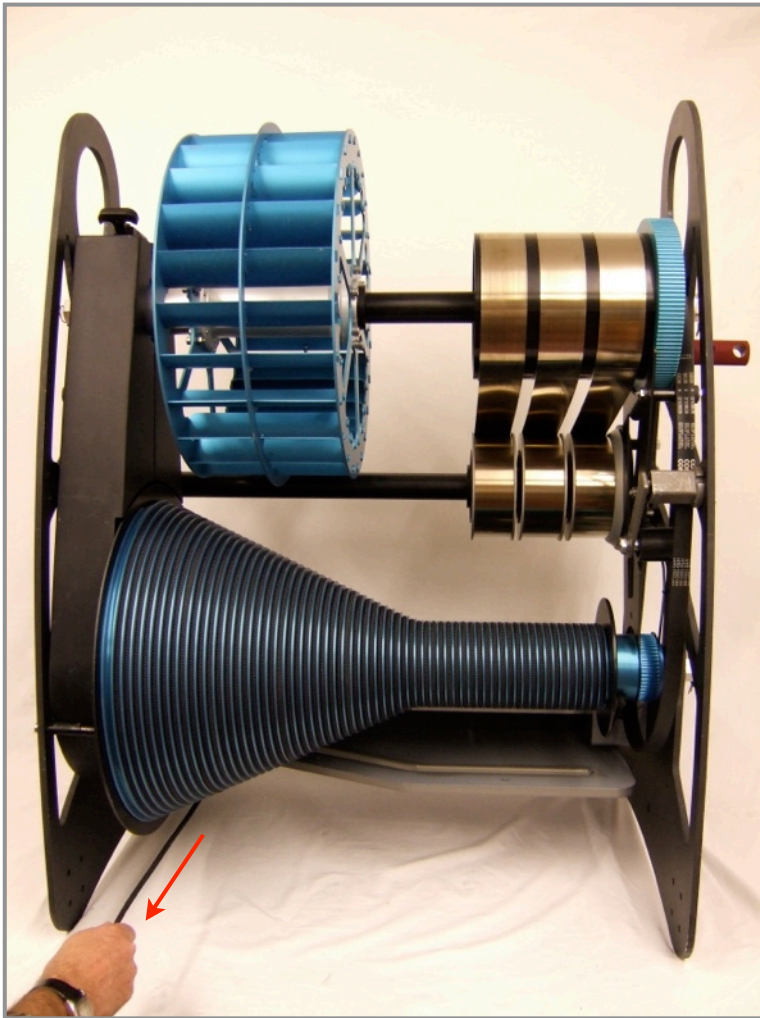

Figure 20

For assistance contact Dropzone.

POWERFAN® is a trading name of **Dropzone (UK) Ltd**, Lasham Woods, Lasham, Alton, GU34 5FZ, UK
t: +441256 381 222 f: +44 870 130 7560 e: info@drop-zone.eu w: www.powerfan.co.uk



Step 4

Once the rewind springs have been isolated, pull the end of the Drope™ so that Drope™ reels off the drum.

Figure 21

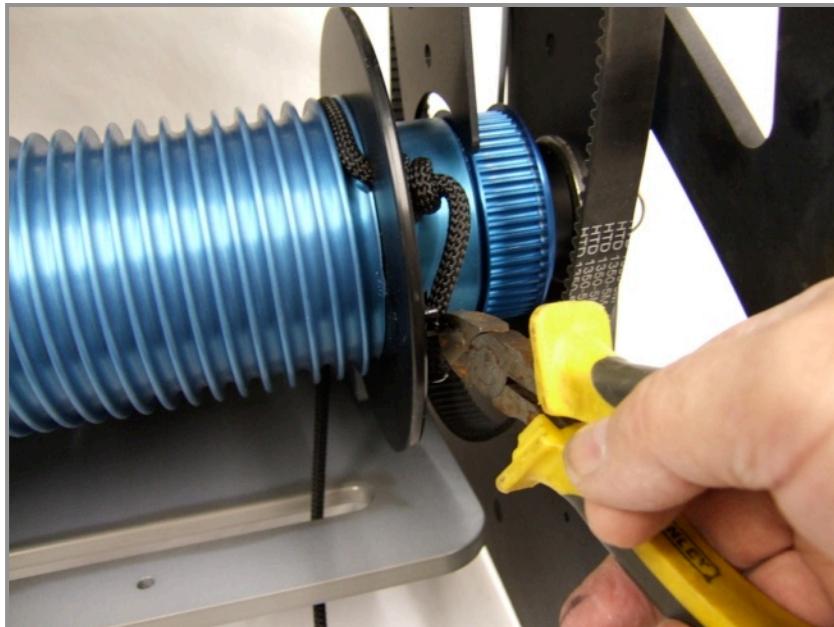

Step 5

Cut the cable tie and undo the stopper knot to release the Drope™ from drum (Figure 22).

Step 6

Discard used Drope™.

Figure 22

End of Drope™ removal instructions.

For assistance contact Dropzone.

5.2 Preparation of a new Drope™

This procedure must always be followed before fitting a new Drope™ to the POWERFAN®. Cutting the Drope™ to the correct length is of critical importance to the safe operation of the POWERFAN®. Note that you must cut the Drope™ in the correct place at the first attempt. Remember the proverb, “measure twice, cut once”! If you have any doubt, please do not hesitate to contact Dropzone.

Step 1

Attach the karabiner to the shock absorbing lanyard. Connect the shock absorbing lanyard to the eye on the end of the Drope™ with the maillon as shown in figure 23.



Figure 23

Step 2

Using a tape measure, carefully measure the vertical distance from the underside of the lower guide plate to the ground surface at the landing area. It is important that the measurement is accurate to the nearest centimetre. Make a note of this measurement. It will be needed in step 3. Note that since this distance may vary with time this step must be repeated every time a new Drope™ is fitted.

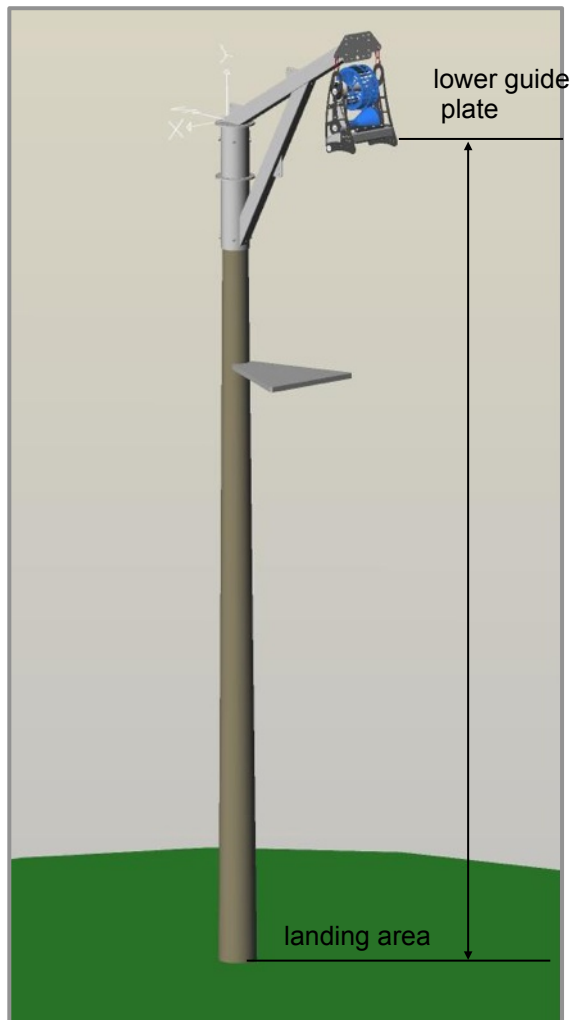

Figure 24

For assistance contact Dropzone.

Step 3

Once the measurement in step 2 has been obtained, the Drope™ should be cut according to the formula shown in figure 25. The Drope™ should be cut so that the overall length including the safety lanyard and karabiner is equal to the measured distance from the underside of the lower guide plate to the ground plus 2.08 metres.

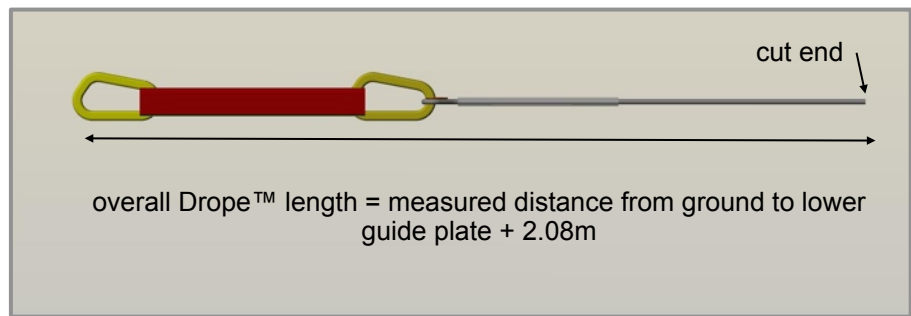

Figure 25

Tip: Using a hot knife or rope cutter, cut the Drope™ at an angle as shown in figure 23. This will assist with feeding the Drope™ through the hole in the small flange.

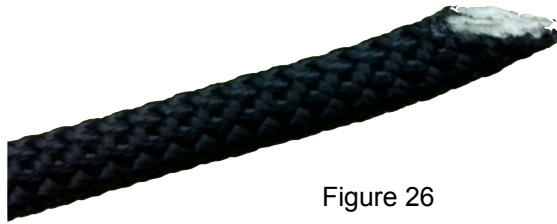

Figure 26

Step 4

Before fitting the new Drope™ onto the POWERFAN®, the rubber stop block should be threaded onto the Drope™. The Drope™ clamps should then be positioned on the Drope™ as shown so that the distance from karabiner to the top of the rubber stop block is 1.36m. This will ensure that the participant attachment karabiner is reachable from the step-off platform when the Drope™ is fully rewound. If the distance from the step off platform to the lower guide plate is greater than 2.5m then the position of the Drope™ clamps should be adjusted accordingly.

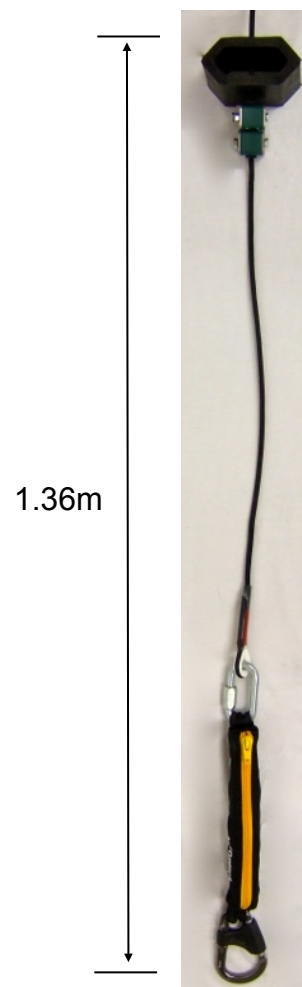

Figure 27

For assistance contact Dropzone.

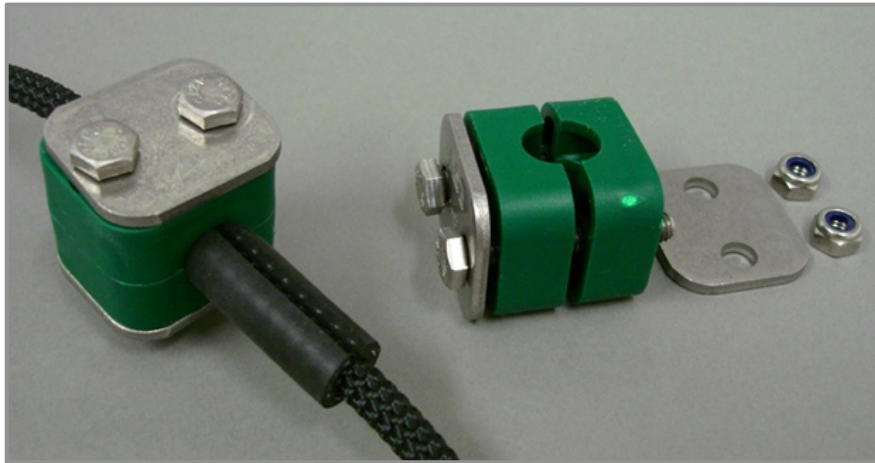

Figure 28

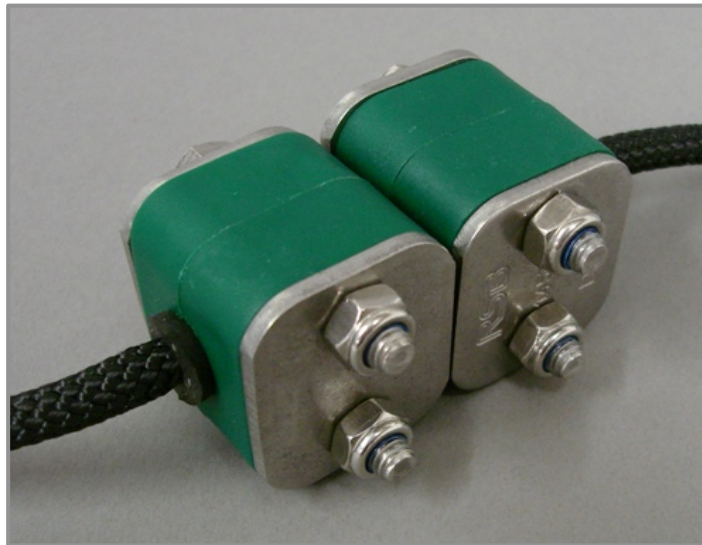

Figure 29

End of Drope™ preparation instructions.

For assistance contact Dropzone.

POWERFAN® is a trading name of **Dropzone (UK) Ltd**, Lasham Woods, Lasham, Alton, GU34 5FZ, UK
t: +441256 381 222 f: +44 870 130 7560 e: info@drop-zone.eu w: www.powerfan.co.uk

5.3 Fitting a new Drope™

Note that once the Drope™ has been cut to length according to the instructions in section 5.2, the Drope™ should not be subjected to further cutting or trimming during the fitting process described below. With the upper spring drum locked off using the stop screw and the spring rewind belt removed from the rewind pulleys (see section 5.1, step 2 and step 3), proceed as follows:

Step 1

Pass the end of the Drope™ up through the slot in the lower guide plate, up between the upper guide plate and the rope drum and through the hole in the small flange as shown in Figures 30 to 32. Pull approximately 300-400mm of Drope™ through the hole in the small flange.

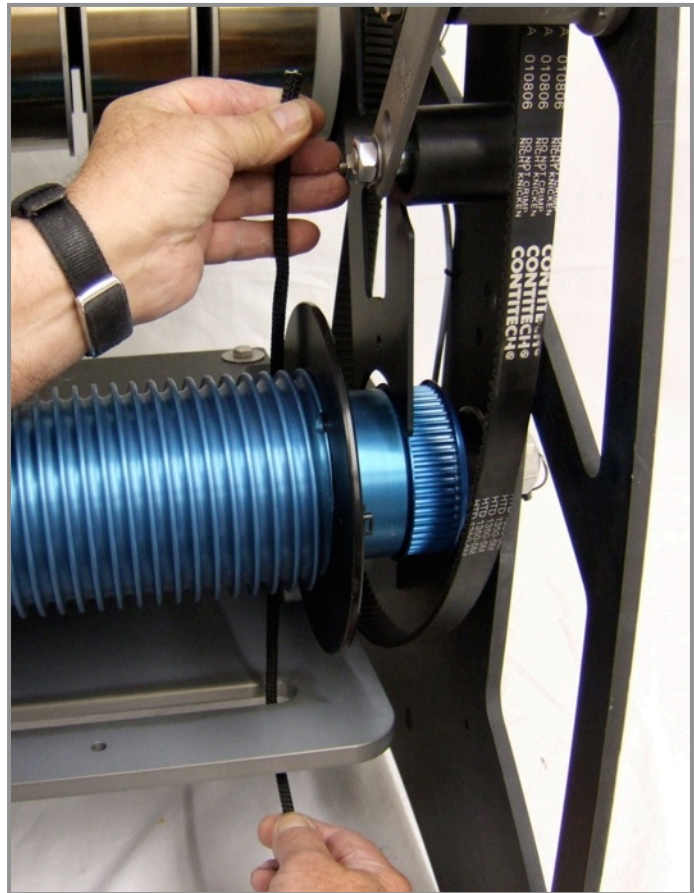

Figure 30

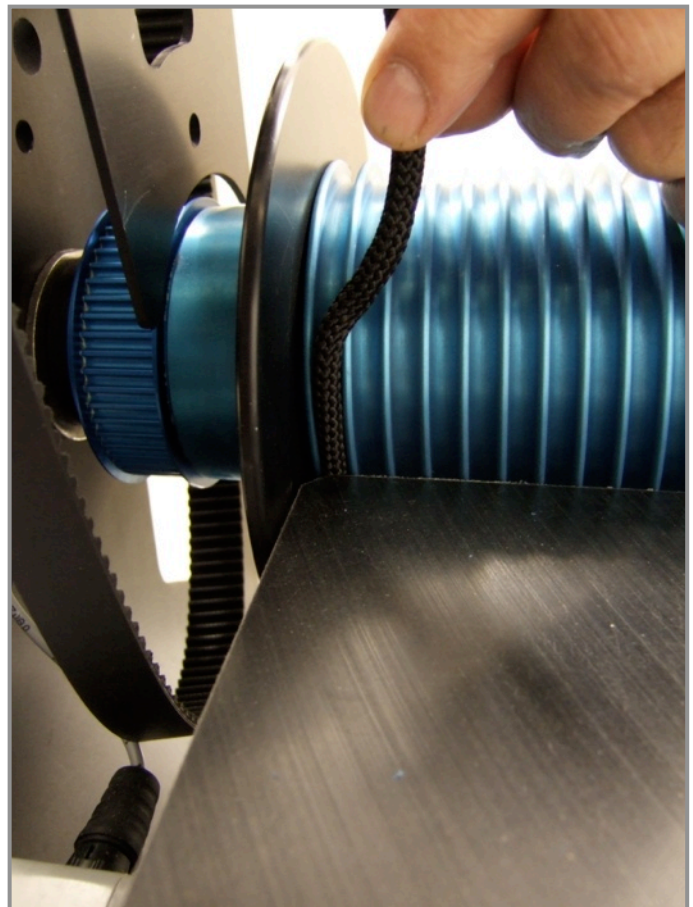

Figure 31

For assistance contact Dropzone.

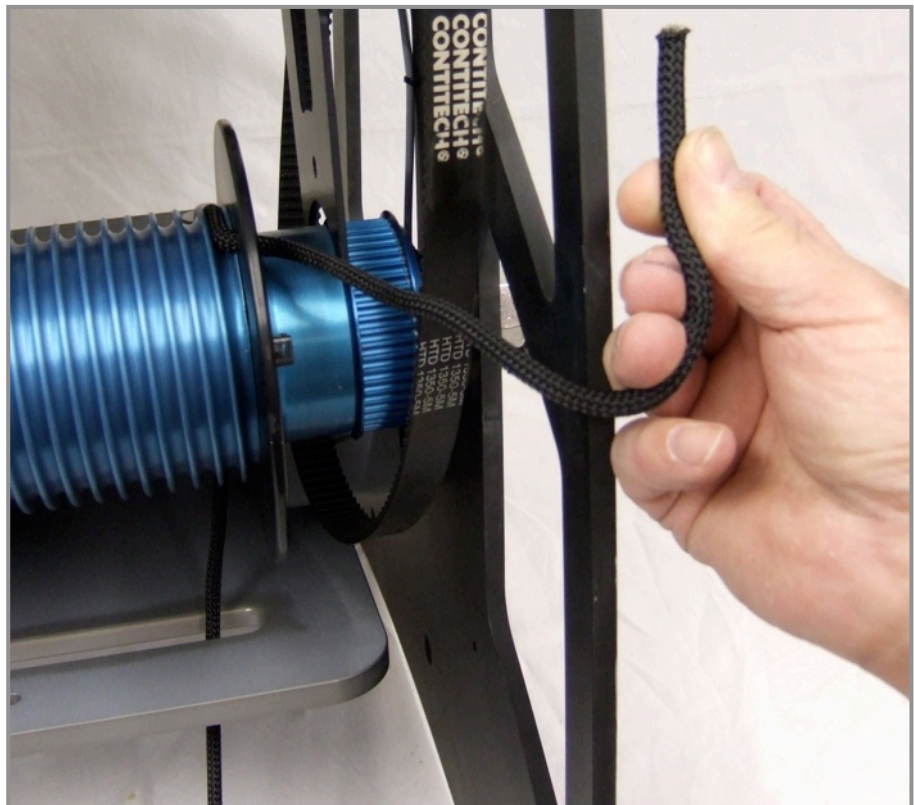

Figure 32

Step 2

Tie a double overhand stopper knot in the Drope™ leaving a tail of approximately 40-50mm. Pull the Drope™ back through the hole in the small flange so that the stopper knot sits hard up against the small flange.

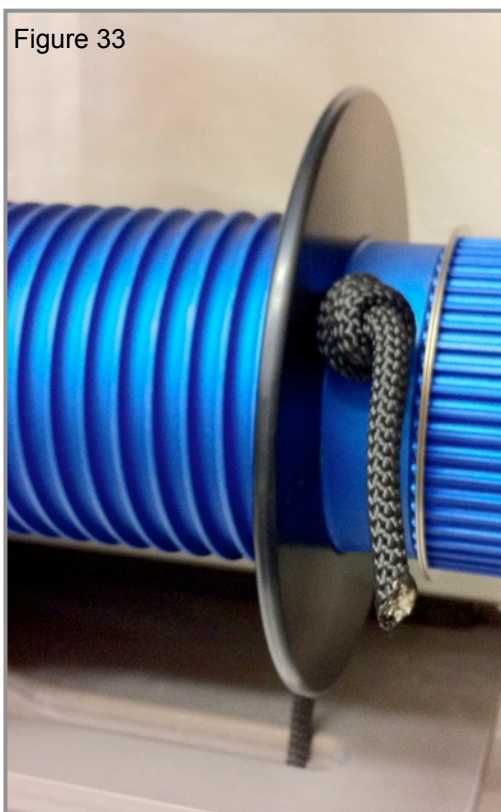
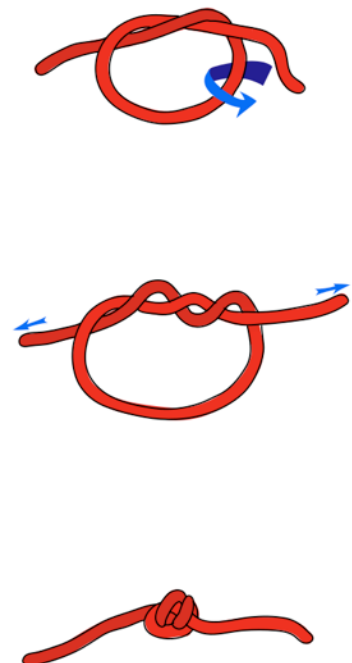

Figure 33

Figure 34:
Double
overhand
stopper knot



For assistance contact Dropzone.

Step 3

Thread the cable tie through the two holes in the flange as shown in figure 35a. Fasten the tail of the Drope to the small flange using a cable tie as shown in figure 35b. Trim the excess cable tie. There should be approximately 10 to 15mm of Drope tail left projecting beyond the cable tie.

Figure 35a



Figure 35b

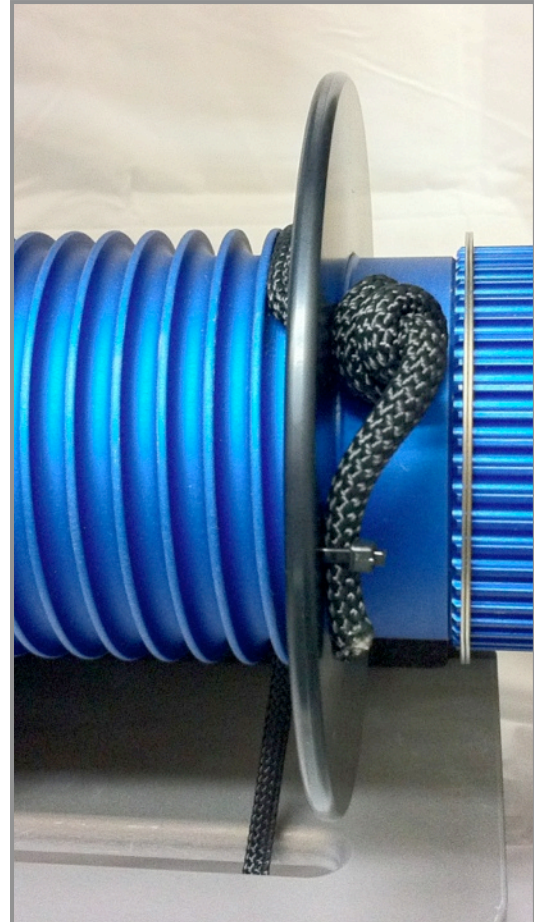

For assistance contact Dropzone.

POWERFAN® is a trading name of **Dropzone (UK) Ltd**, Lasham Woods, Lasham, Alton, GU34 5FZ, UK
t: +441256 381 222 f: +44 870 130 7560 e: info@drop-zone.eu w: www.powerfan.co.uk

Step 4

Maintaining a little hand tension on the Drope™ wind the Drope™ onto the drum by rotating the fan by hand. Wind the Drope™ onto the drum until the rubber stop block comes into contact with the lower guide plate.

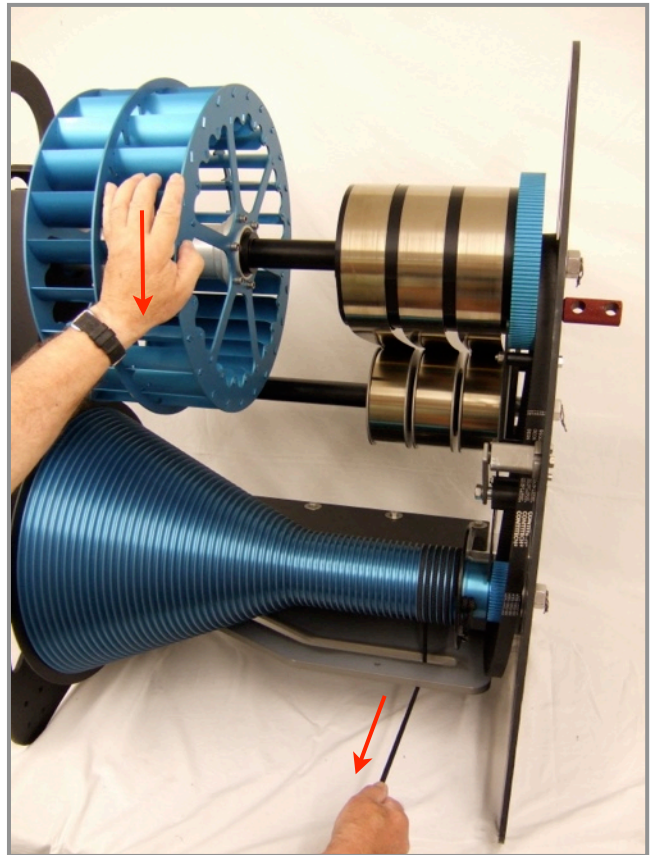

Figure 36

Step 5

Making sure that the rubber stop block is kept in contact with the lower guide plate, refit the rewind belt to the upper and lower rewind pulleys.

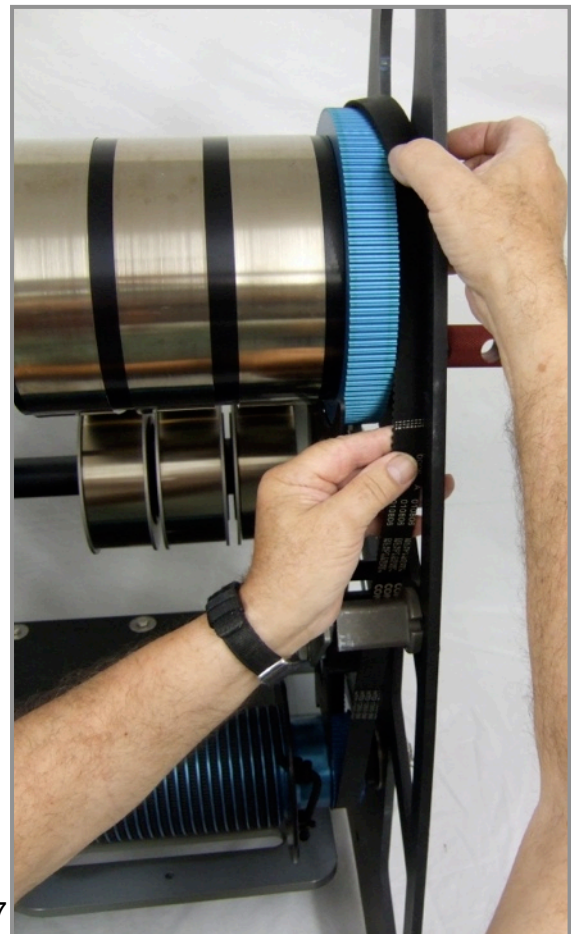

Figure 37

For assistance contact Dropzone.

Step 6

Reposition the belt tensioner in front of the rewind belt so that the belt is tensioned.

Figure 38

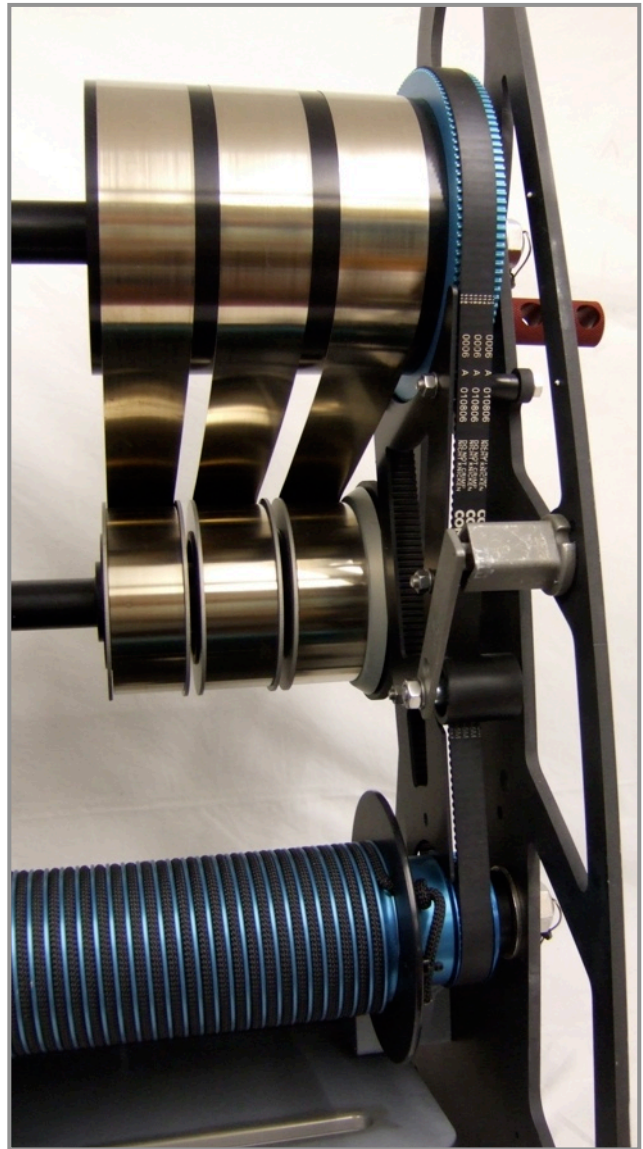

Step 7

Remove the stop screw from the upper spring drum.

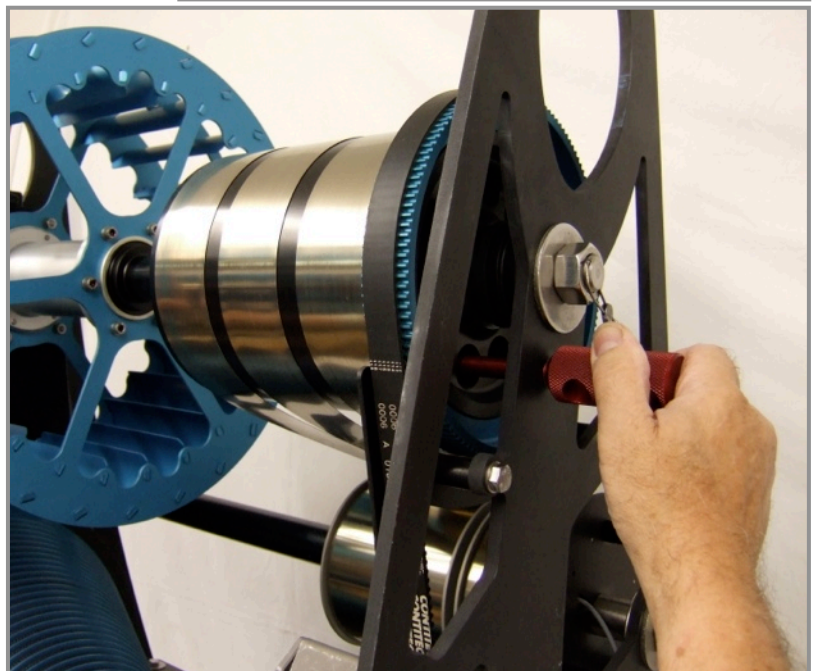

Figure 39

For assistance contact Dropzone.

Step 8

Check that the correct length of Drope™ has been fitted to the POWERFAN®. This is done by pulling the Drope™ off the rope drum until the attachment karabiner is touching the ground at the landing area and counting the remaining turns of Drope™ left on the rope drum. There should be four turns plus or minus one turn.

The Drope™ replacement process is now completed by reeling the Drope™ off the rope drum as far as possible and then allowing the spring to rewind the Drope™ whilst maintaining some tension on the Drope™ by hand. This ensures that the Drope™ seats properly into the grooves on the rope drum. Record the fact that the Drope™ was changed along with the counter number in the logbook.

End of instructions for fitting new Drope™.

6. Spring Replacement

Spring replacement should be recorded in the maintenance and inspection log book. Only springs from an authorised Powerfan distributor or from Dropzone may be used.

6.1 Removing used rewind springs

This section gives the procedure for the removal of used springs that have not parted. In circumstances where a spring has parted, please contact Dropzone for advice.

WARNING: the rewind spring has sharp edges and requires careful handling. It is important to wear the correct personal protective equipment. If there is any doubt about handling the spring please contact Dropzone for advice.

Step 1

Allow the springs to rewind the Drope™ fully so that the rubber stop block comes into contact with the lower guide plate.

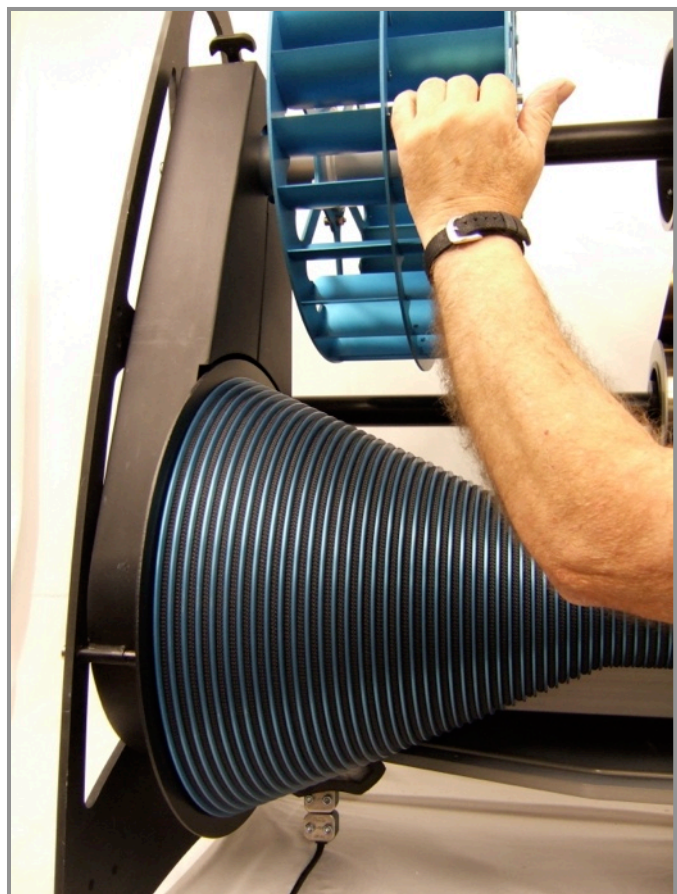

Figure 40
For assistance contact Dropzone.

Step 2

Insert the stop screw and release the tensioner from the rewind belt and remove the rewind belt from the rewind pulleys. (Figures 41 to 47)

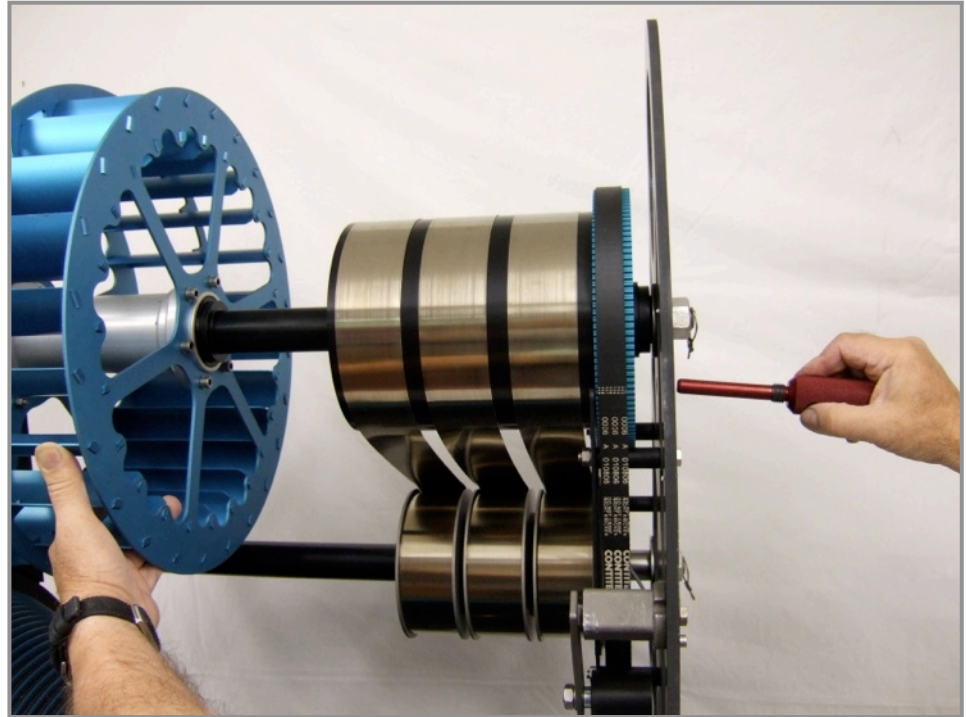

Figure 41

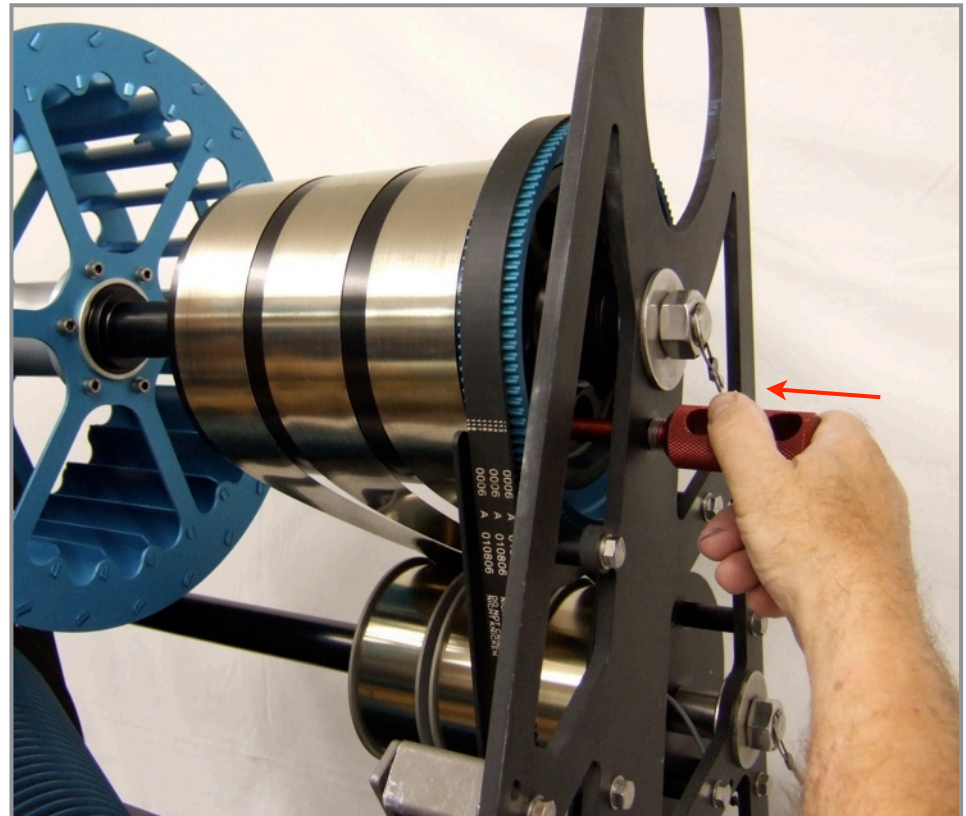

Figure 42

For assistance contact Dropzone.

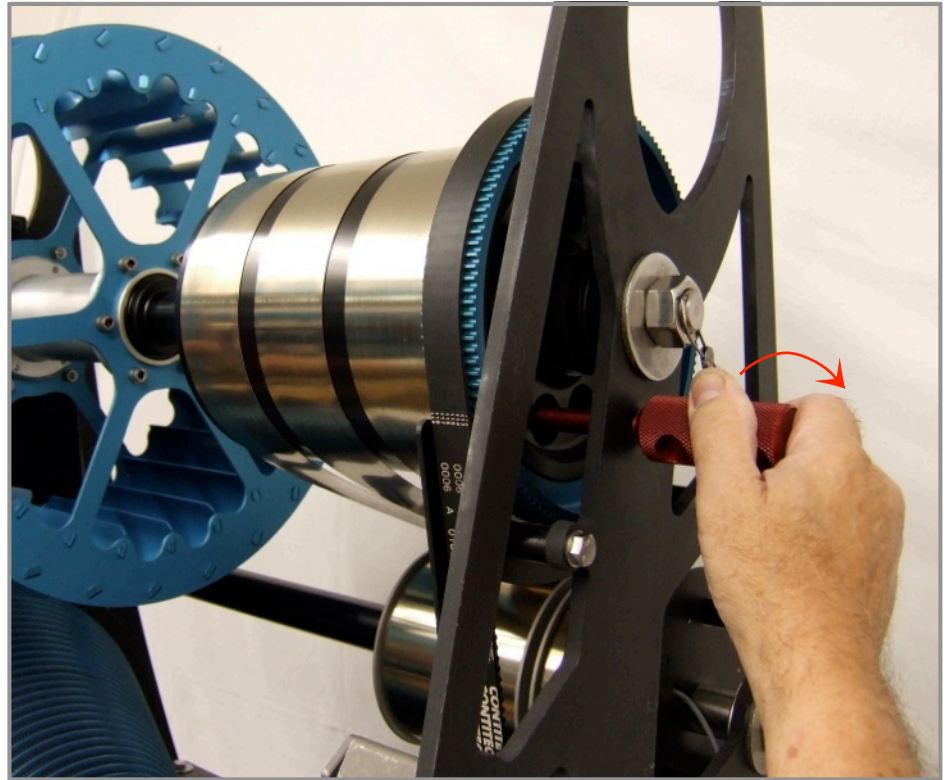

Figure 43

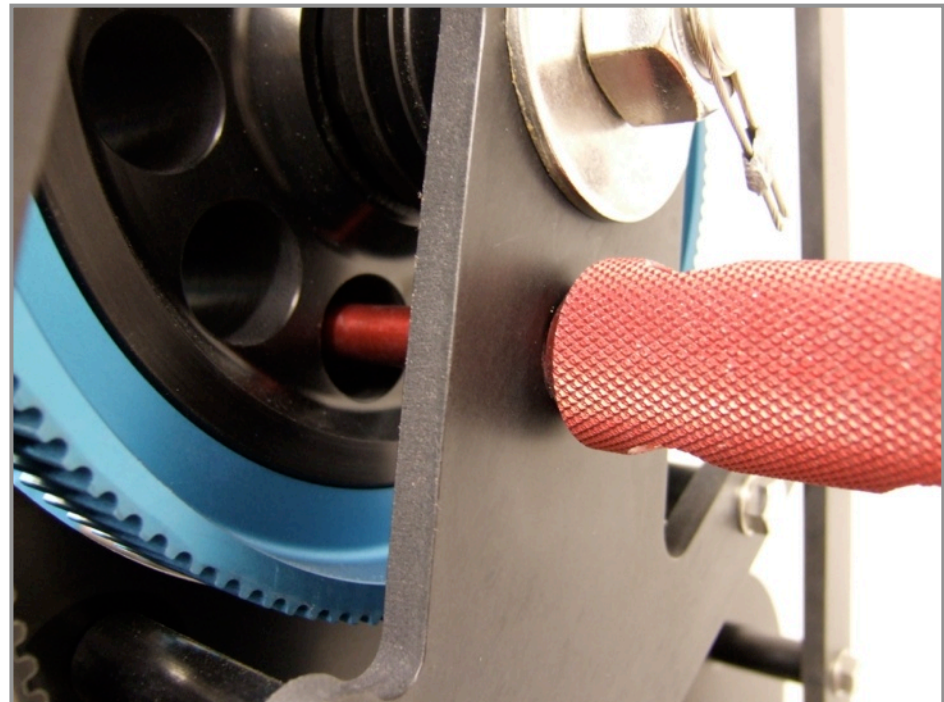

Figure 44

For assistance contact Dropzone.

POWERFAN® is a trading name of **Dropzone (UK) Ltd**, Lasham Woods, Lasham, Alton, GU34 5FZ, UK
t: +441256 381 222 f: +44 870 130 7560 e: info@drop-zone.eu w: www.powerfan.co.uk

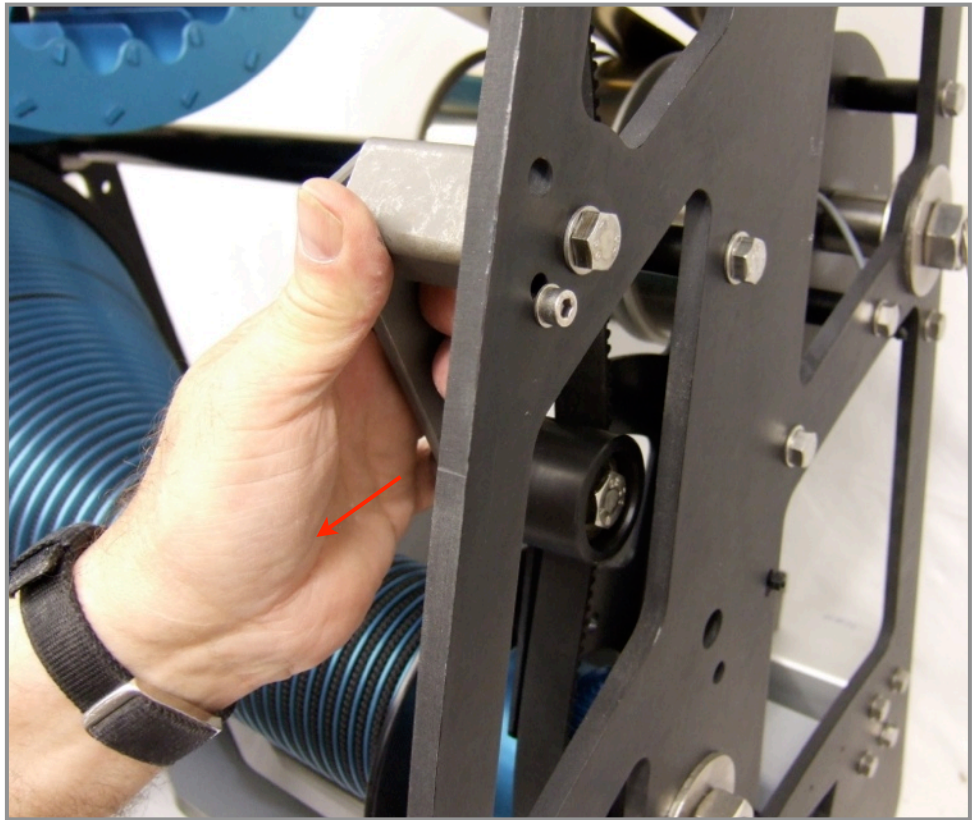

Figure 45

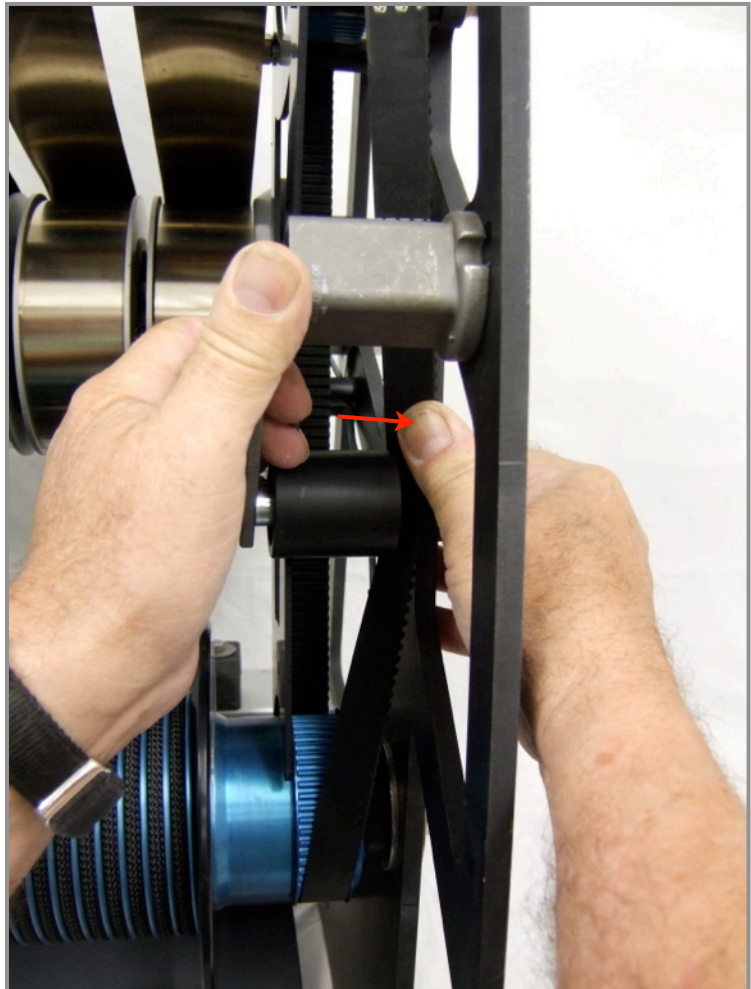

Figure 46

For assistance contact Dropzone.

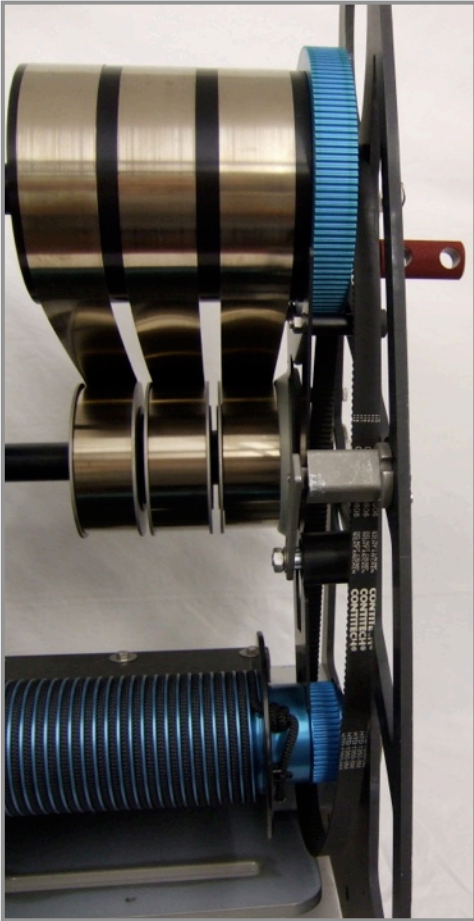

Figure 47

Step 3

Now that the rewind has been isolated from the rope drum, pull approximately 5 metres of Drope™ from the rope drum.

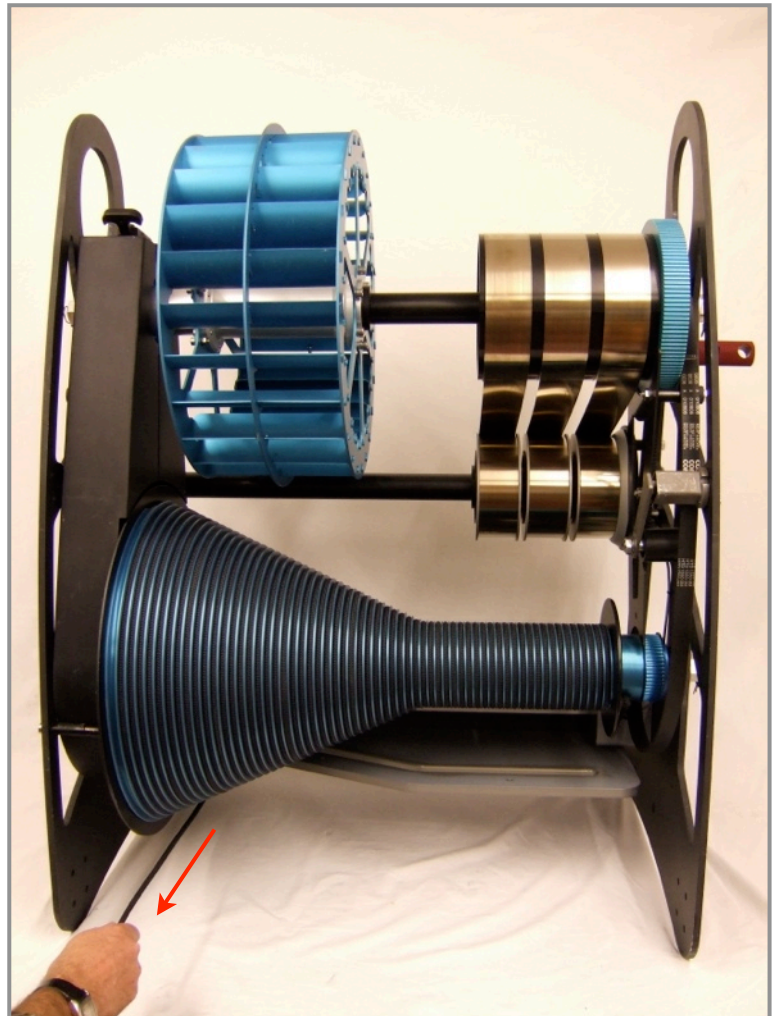

Figure 48

For assistance contact Dropzone.

Step 4

Making sure that there is approximately 5 metres of Drope™ between the rubber stop block and the lower guide plate, refit the rewind belt to the upper and lower rewind pulleys and reposition the belt tensioner in front of the rewind belt.

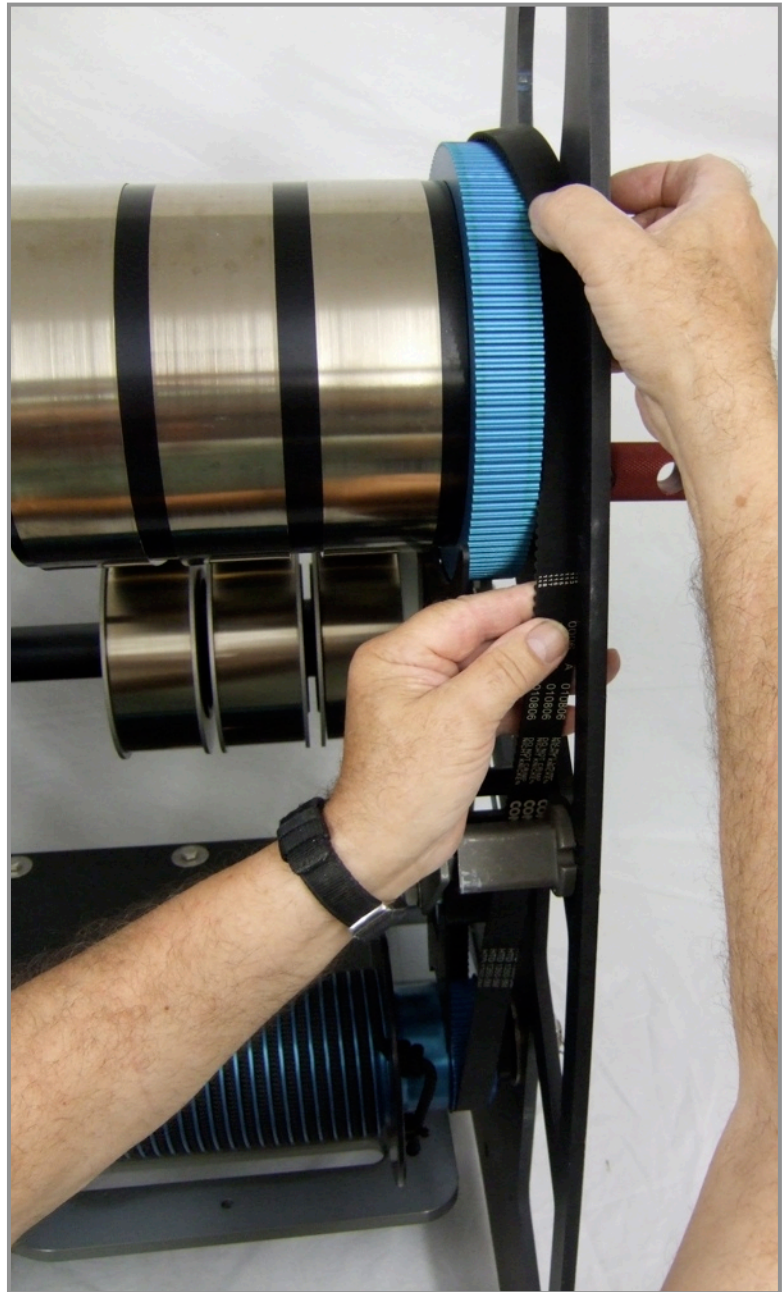

Figure 49

For assistance contact Dropzone.

POWERFAN® is a trading name of **Dropzone (UK) Ltd**, Lasham Woods, Lasham, Alton, GU34 5FZ, UK
t: +441256 381 222 f: +44 870 130 7560 e: info@drop-zone.eu w: www.powerfan.co.uk

Step 5

Take hold of the Drope™ firmly (without pulling on it) and remove the stop screw from the upper spring drum whilst continuing to hold the Drope™ firmly. You should feel a gentle tension come onto the Drope™ from the rewind springs as the stop screw is removed. After the stop screw is removed, allow the Drope™ to be rewound onto the drum slowly until the upper spring drum is in the position shown in figure 51.

Step 6

Reinsert the stop screw (figure 52).

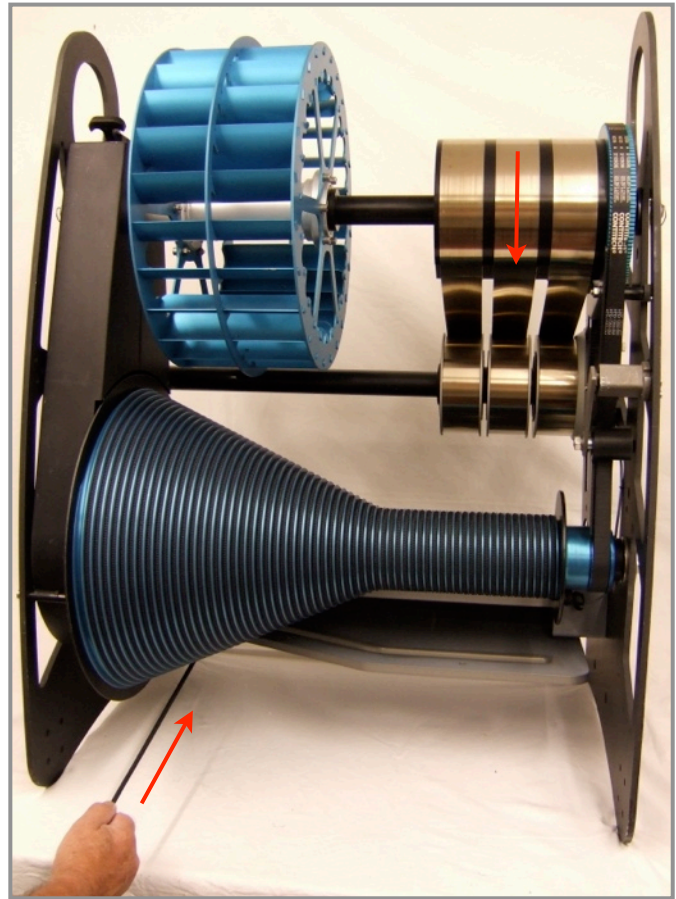

Figure 51

Figure 50

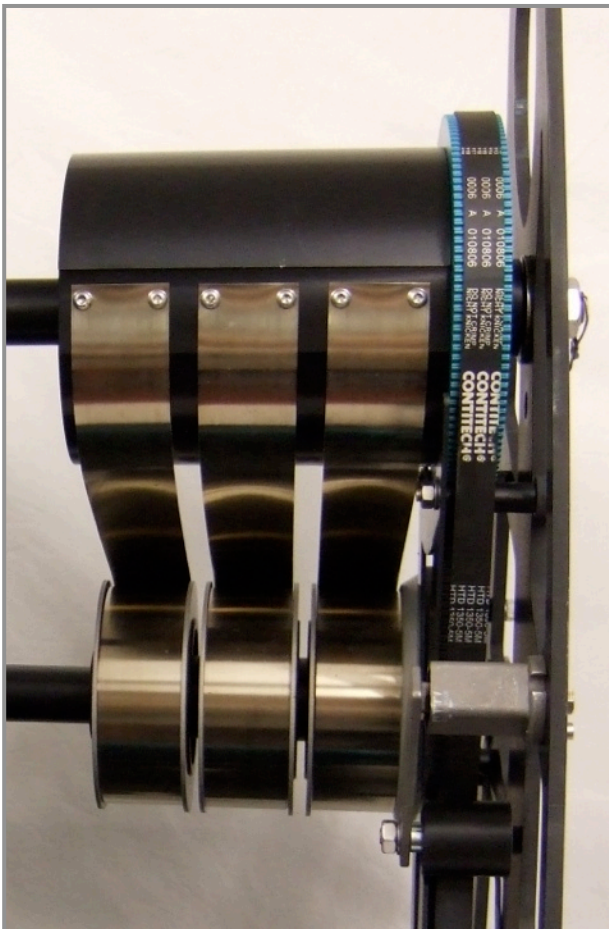
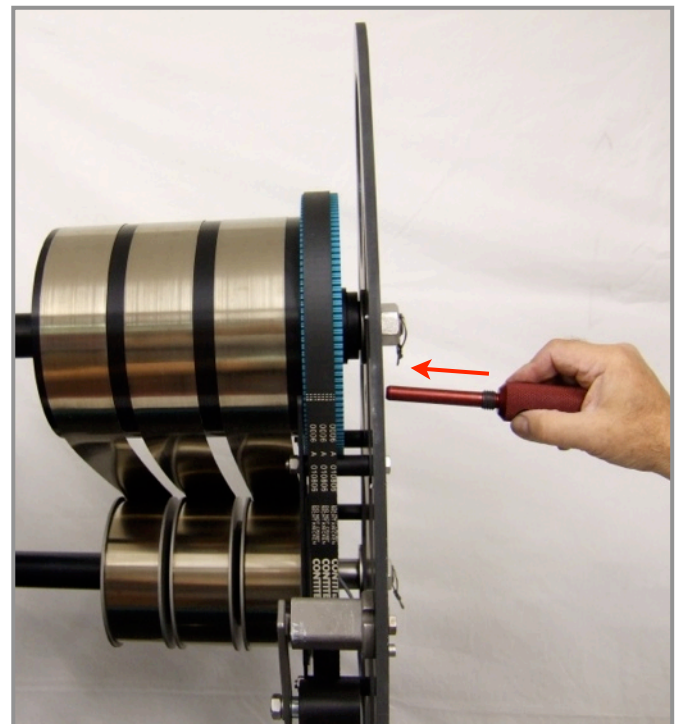
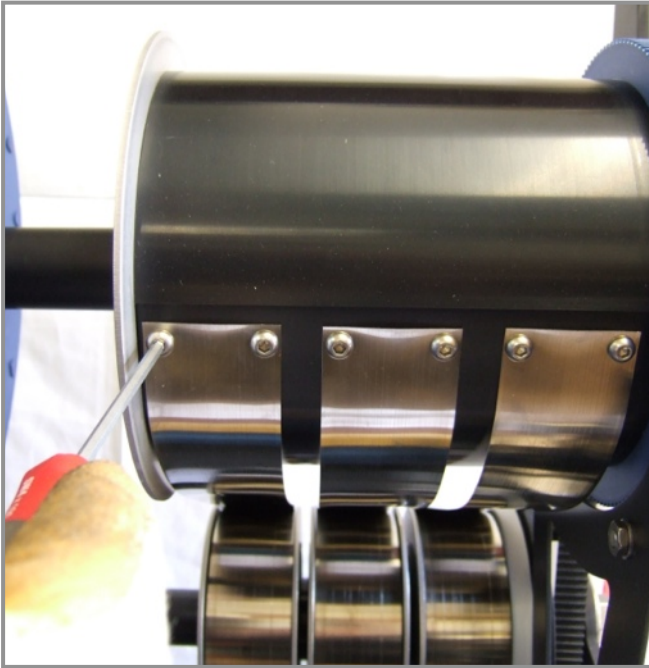

Figure 52



For assistance contact Dropzone.

Figure 53



Step 7

Using a 4mm hex key, detach the springs from the upper spring drum. It is easiest to work from left to right, undoing the left-hand spring first. Then the middle one. And finally the right-hand one.

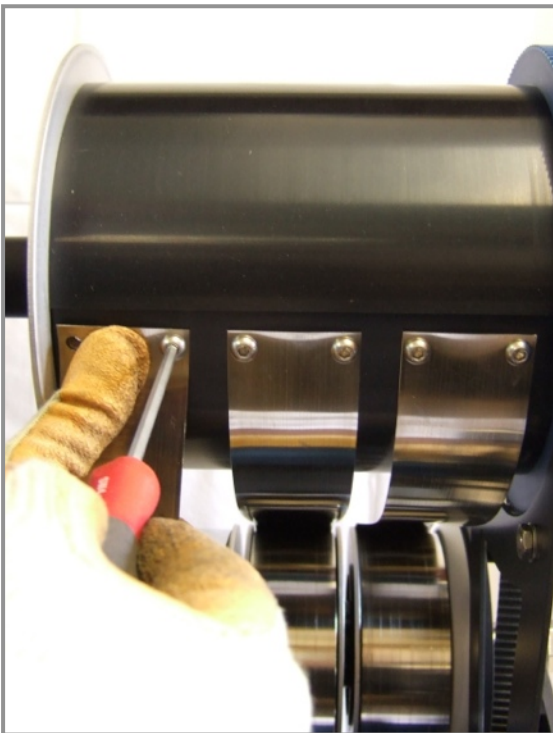

Figure 54

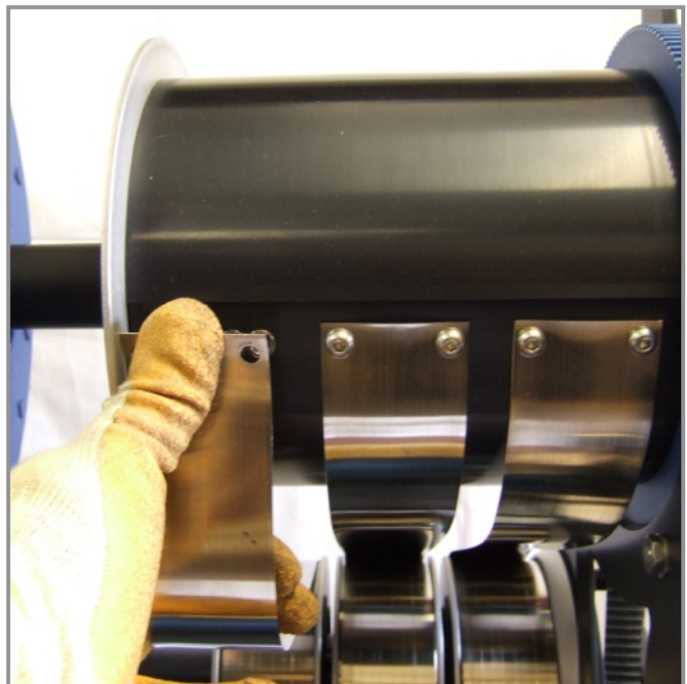

Figure 55

For assistance contact Dropzone.

POWERFAN® is a trading name of **Dropzone (UK) Ltd**, Lasham Woods, Lasham, Alton, GU34 5FZ, UK
t: +441256 381 222 f: +44 870 130 7560 e: info@drop-zone.eu w: www.powerfan.co.uk

Step 8

After detaching each spring coil it onto the lower spring drums as shown in Figures 56 to 57.

Figure 56

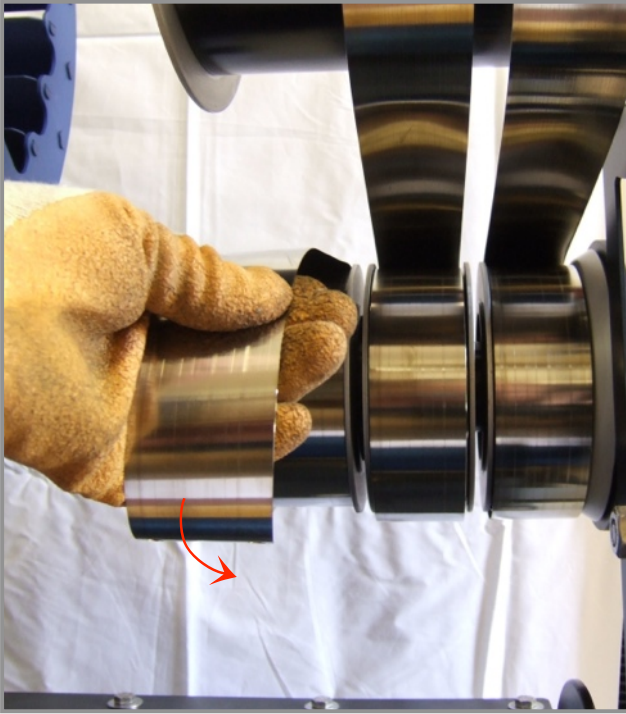
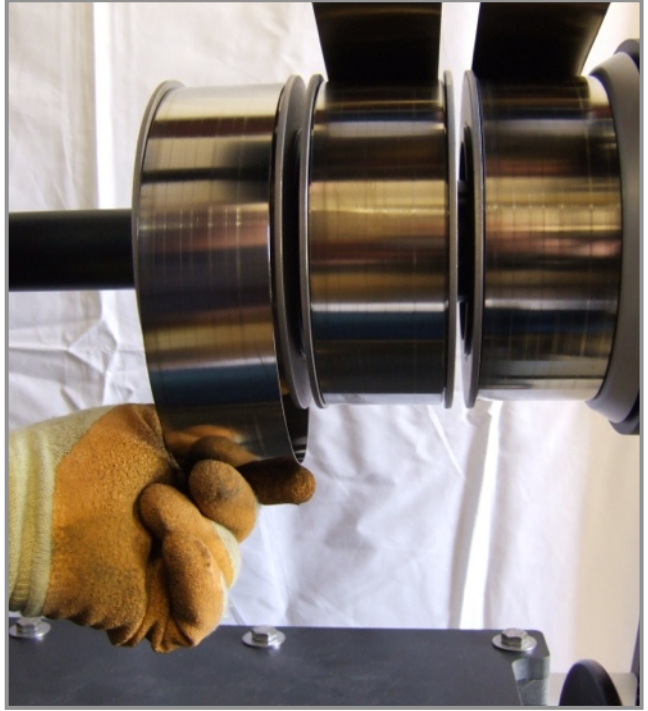

Figure 57



Step 9

Remove the used springs from the lower spring drums as shown in Figures 58 to 60.

Note: Please be careful when uncoiling the last turn of the spring (shown in Figure 59). If removed in an uncontrolled manner it may come off the drum with some force potentially causing injury.

Figure 58

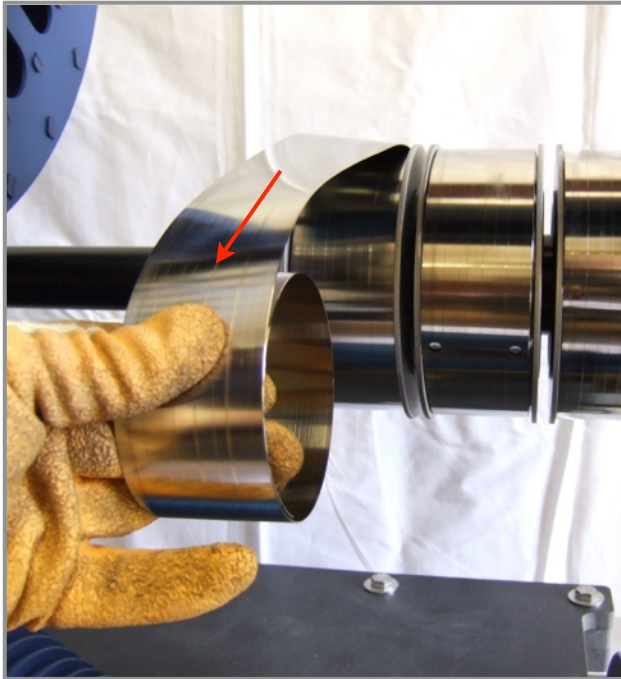
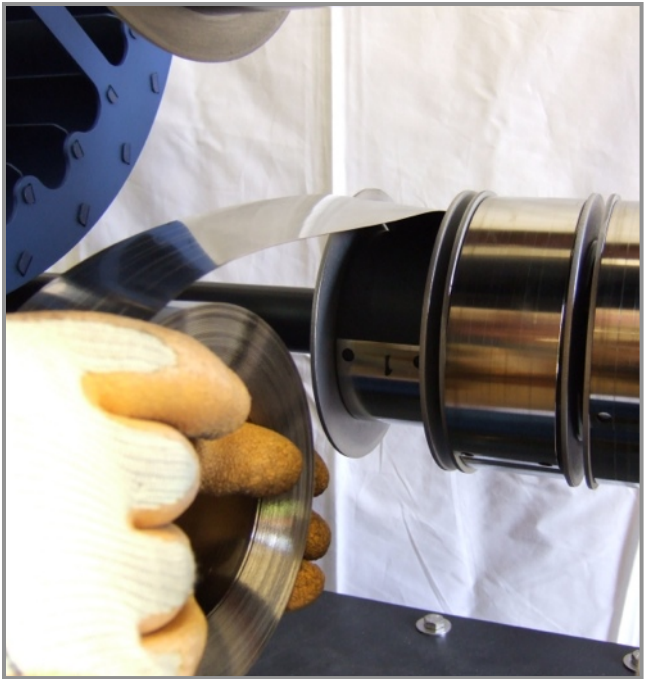

Figure 59



For assistance contact Dropzone.

Figure 60



Step 10
Discard used springs.

End of spring removal instructions.

6.2 Fitting new rewind springs

This section gives the procedure for fitting a replacement spring. Replacement springs must be obtained from an authorised Powerfan distributor or from Dropzone.

Step 1
Feed the springs onto the lower spring drums as shown in figure 61.

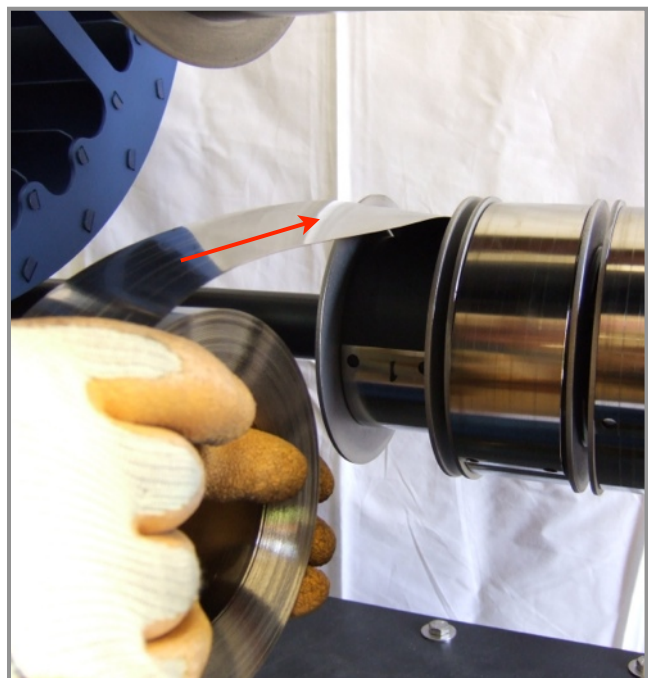

Figure 61

For assistance contact Dropzone.

Step 2

Attach the end of the springs to the upper spring drum using the supplied screws as shown in figures 62 to 65.

Figure 62

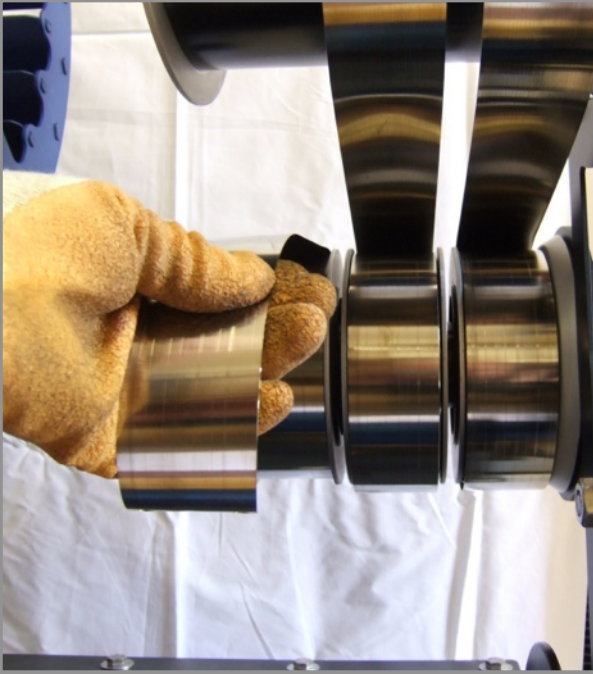

Figure 63



Figure 64

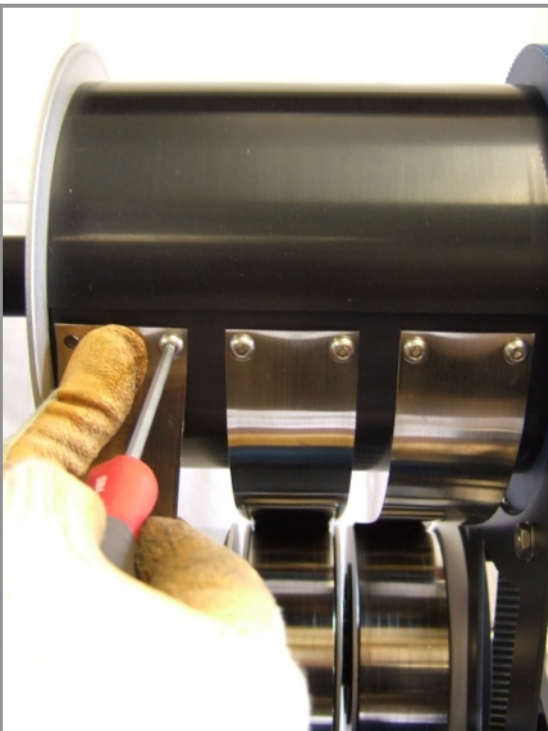
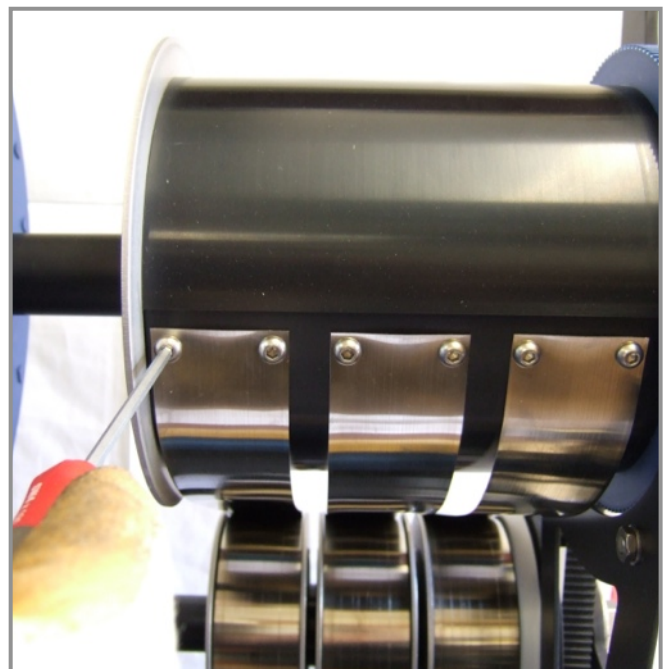

Figure 65



For assistance contact Dropzone.

Step 3

By rotating the fan by hand in the direction shown, wind one complete turn of the new springs onto the upper spring drum.

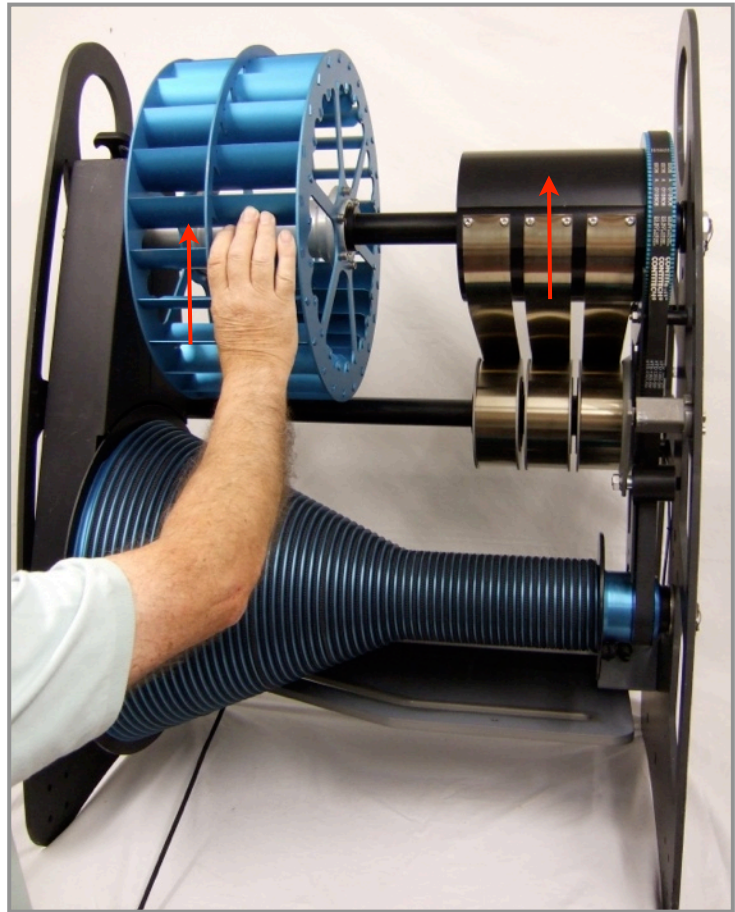

Figure 66

Step 4

Keeping hold of the fan with one hand, lock off the upper spring drum with the stop screw.

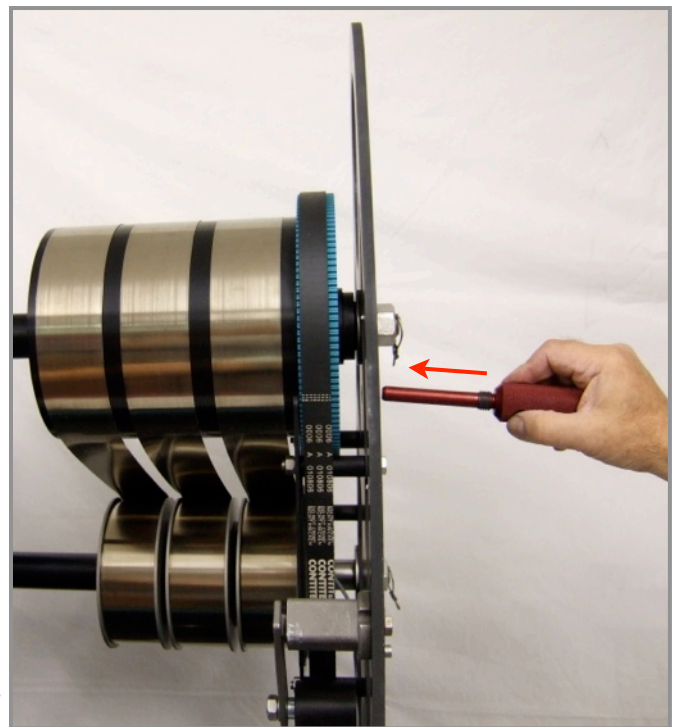

Figure 67

For assistance contact Dropzone.

POWERFAN® is a trading name of **Dropzone (UK) Ltd**, Lasham Woods, Lasham, Alton, GU34 5FZ, UK
t: +441256 381 222 f: +44 870 130 7560 e: info@drop-zone.eu w: www.powerfan.co.uk

Step 5

Remove the rewind belt from the pulleys.

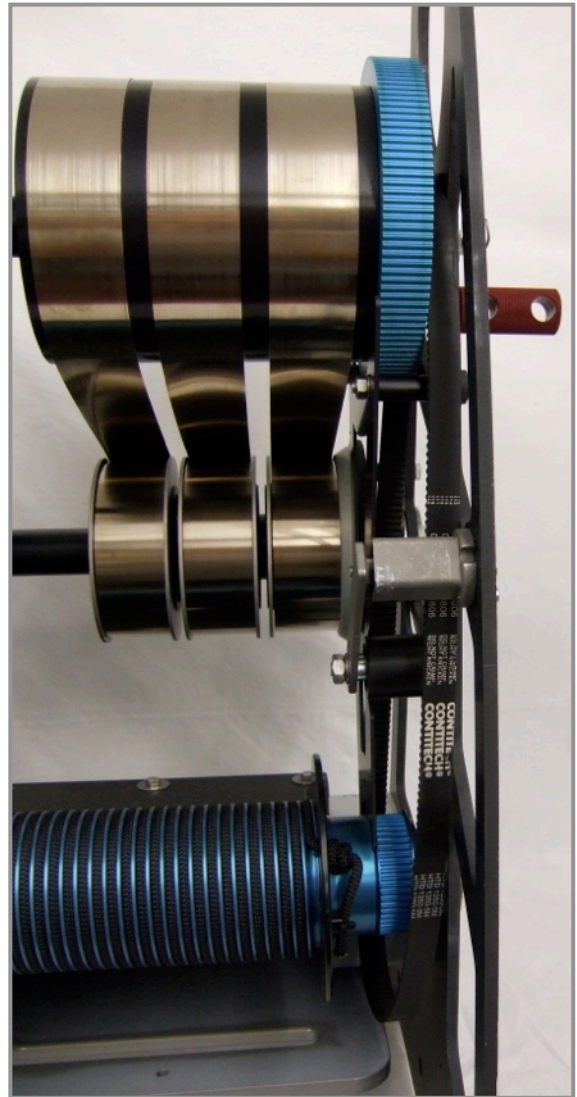

Figure 68

Step 6

Wind the Drope™ onto the drum so that the rubber stop block is touching the lower guide plate.

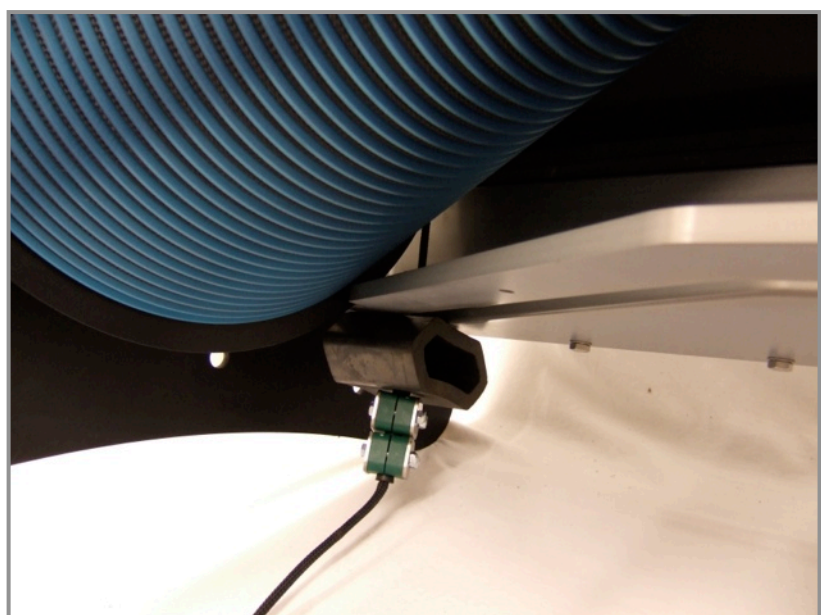

Figure 69

For assistance contact Dropzone.

Step 7

Refit the rewind belt while keeping the fan stationary.

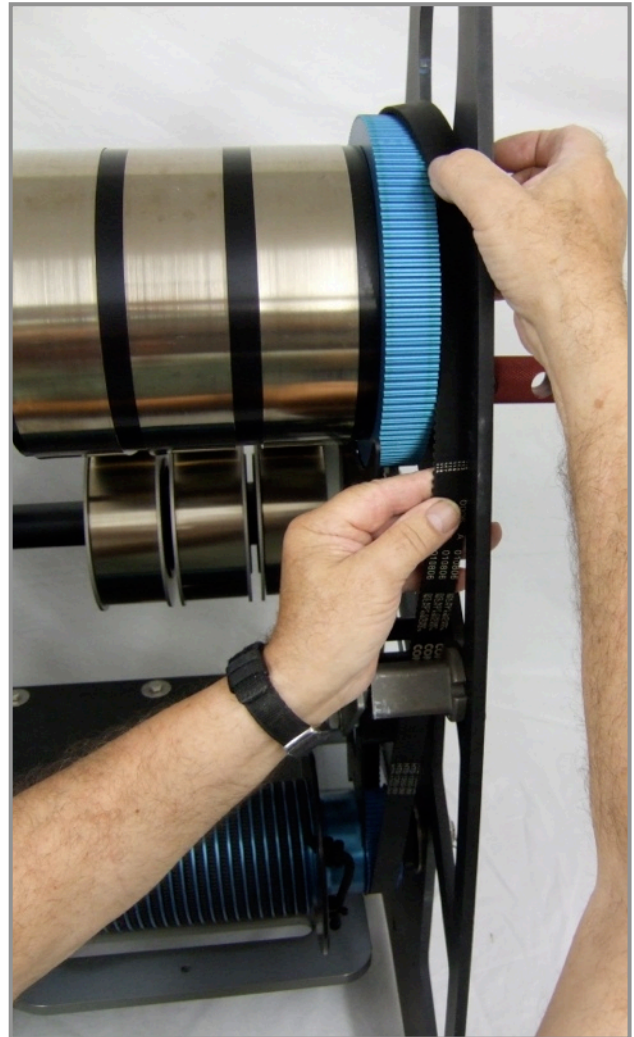

Figure 70

Step 8

Remove the stop screw.

Step 9

Record the fact that the spring has been changed.

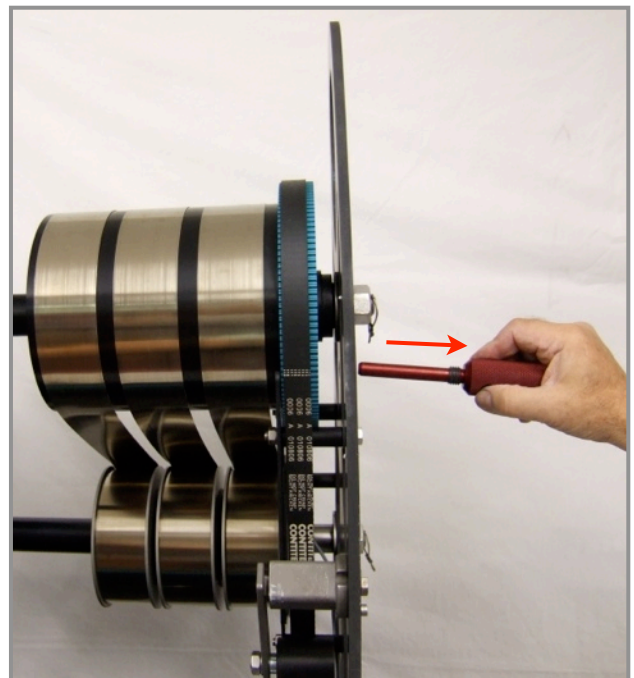

Figure 71

End of instructions for fitting a new rewind spring.

For assistance contact Dropzone.

POWERFAN® is a trading name of **Dropzone (UK) Ltd**, Lasham Woods, Lasham, Alton, GU34 5FZ, UK
t: +441256 381 222 f: +44 870 130 7560 e: info@drop-zone.eu w: www.powerfan.co.uk

7. POWERFAN® Installation

Note: the information in this section is intended for general guidance only. Contact Dropzone for the detailed drawings and specifications required for correct POWERFAN® installation.

7.1 General mounting arrangement

For the safe and efficient operation of the POWERFAN®, it is important that the mounting arrangement conforms to the dimensions shown on figure 71. There are a number of simple rules that must be followed:

- i. The Drope™ should hang approximately 1050mm horizontally from the front edge of the platform when the Drope™ is fully rewound onto the Drope™ drum.
- ii. The lower guide plate should be 2500mm (or more) above the upper surface of the step-off platform.
- iii. The step-off platform should be no more than 20 metres above the ground at the landing area.
- iv. The descent path must not come closer than 3000mm to any surrounding structure or obstacle.
- v. The landing area should conform to EN1177. Obstacles within 3.5m of the landing point may require protective padding.

For more detailed information on mounting the POWERFAN® contact Dropzone.

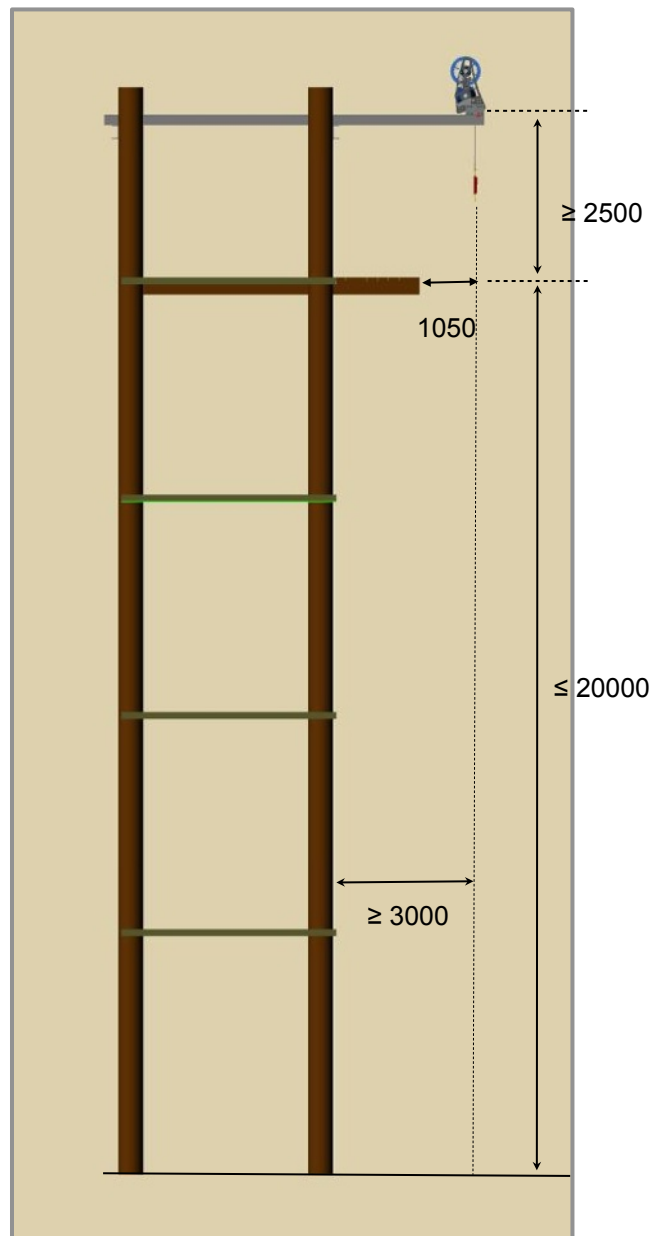

Figure 72
(Dimensions in millimeters)

For assistance contact Dropzone.

7.2 Mounting types

There are two basic ways in which the POWERFAN® can be mounted and these are shown in figures 72 and 73. Further details and dimensions relating to each of these mounting arrangements can be obtained from Dropzone.

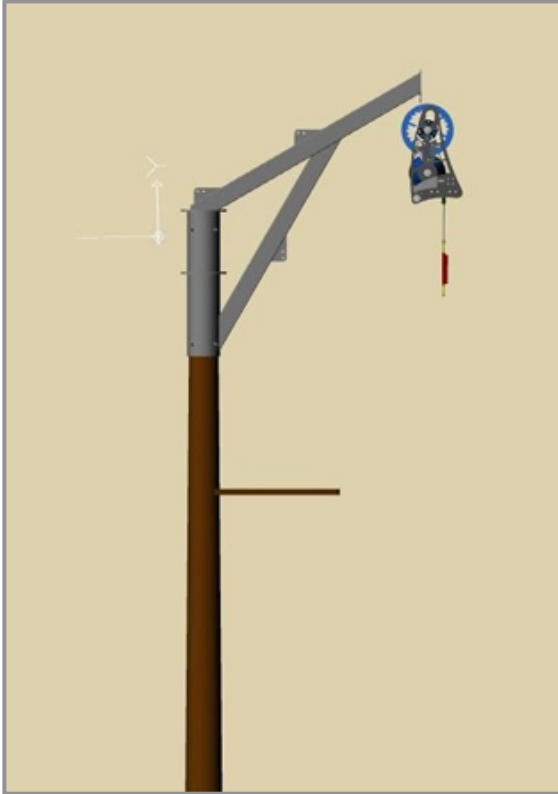

Figure 73 POWERFAN® mounted below supporting structure.

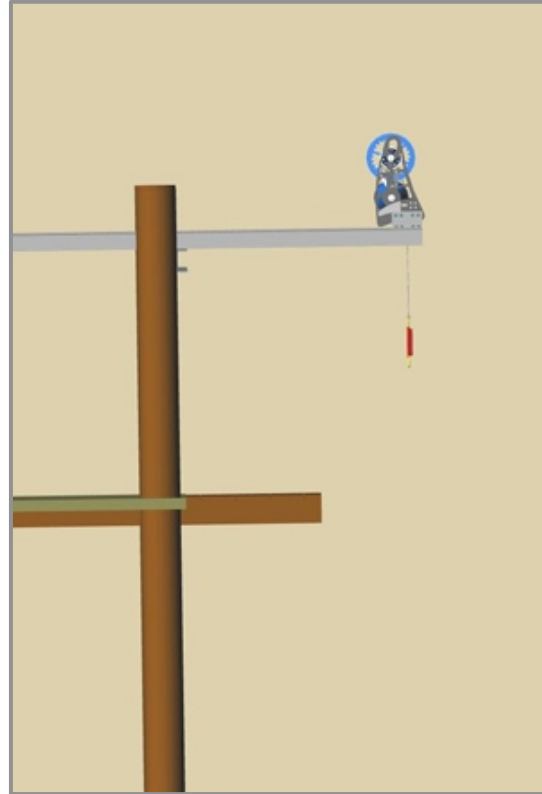

Figure 74 POWERFAN® mounted standing on top of supporting structure.

For assistance contact Dropzone.

POWERFAN® is a trading name of **Dropzone (UK) Ltd**, Lasham Woods, Lasham, Alton, GU34 5FZ, UK
t: +441256 381 222 f: +44 870 130 7560 e: info@drop-zone.eu w: www.powerfan.co.uk