

**POWERFAN**<sup>™</sup>

## **PF13 Inspection & Maintenance Manual**

Version 1.6 (September 2012)

# Contents

|  |          |
|--|----------|
| <b>1. Warning</b>                                  | <b>3</b> |
| <b>2. Terminology</b>                              |          |
| Figure 1: POWERFAN® PF13 and Drope™                | 4        |
| Figure 2: POWERFAN® PF13 with belt guard retracted | 5        |
| Figure 3: POWERFAN® general mounting arrangement   | 6        |
| <b>3. Getting started</b>                          |          |
| 3.1 Preparing your POWERFAN® for use               | 7        |
| <b>4. Inspection and Maintenance Schedule</b>      |          |
| 4.1 Daily inspection                               | 10       |
| 4.2 Two yearly service                             | 10       |
| 4.4 When to retire a Drope™                        | 10       |
| 4.5 When to retire a rewind spring                 | 10       |
| <b>5. Drope™ Replacement</b>                       |          |
| 5.1 Removing a used Drope™                         | 13       |
| 5.2 Preparation of a new Drope™                    | 18       |
| 5.3 Fitting a new Drope™                           | 21       |
| <b>7. Spring Replacement</b>                       |          |
| 6.1 Removing a used rewind spring                  | 26       |
| 6.2 Fitting a new rewind spring                    | 34       |

## 1. Warning

**Warning:** Failure to adhere to the following instructions is likely to result in very serious injury or death and will invalidate any guarantee. These procedures should only be carried out by a competent person.

Assistance with any of the material contained within this manual may be obtained by contacting Dropzone at:

Dropzone (UK) Ltd  
Lasham Woods  
Lasham Road  
Alton  
GU34 5FZ  
United Kingdom

Tel: +44 1256 381 222  
[info@drop-zone.eu](mailto:info@drop-zone.eu)  
[www.powerfan.co.uk](http://www.powerfan.co.uk)

When operated correctly the Powerfan® will provide years of safe use. These guidelines must be used in conjunction with the *Powerfan® PF13 Installation Specification* and the *Powerfan® Operating Manual*.

## 2. Terminology

Figure 1: Powerfan® PF13 with Drope™

1. Powerfan® PF13
2. Drope™
3. Maillon
4. Shock absorbing lanyard
5. User attachment point  
(Carabiner)

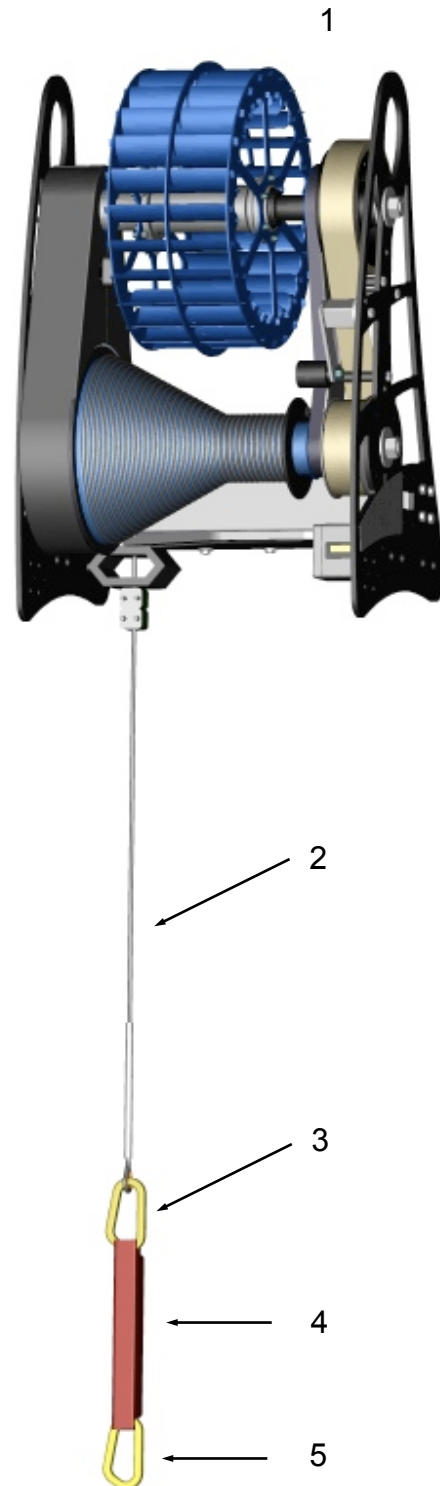

Figure 2: Powerfan® PF13 with belt guard retracted

- |                        |                            |
|------------------------|----------------------------|
| 1. Upper spring drum   | 9. Small flange            |
| 2. Upper rewind pulley | 10. Rope drum              |
| 3. Rewind spring       | 11. Lower guide plate      |
| 4. Rewind belt         | 12. Rubber stop block      |
| 5. Tensioner           | 13. Drope™ clamp assembly  |
| 6. Lower rewind pulley | 14. Retractable belt guard |
| 7. Side plate          | 15. Drive belts            |
| 8. Descent counter     | 16. Flexible draw latch    |

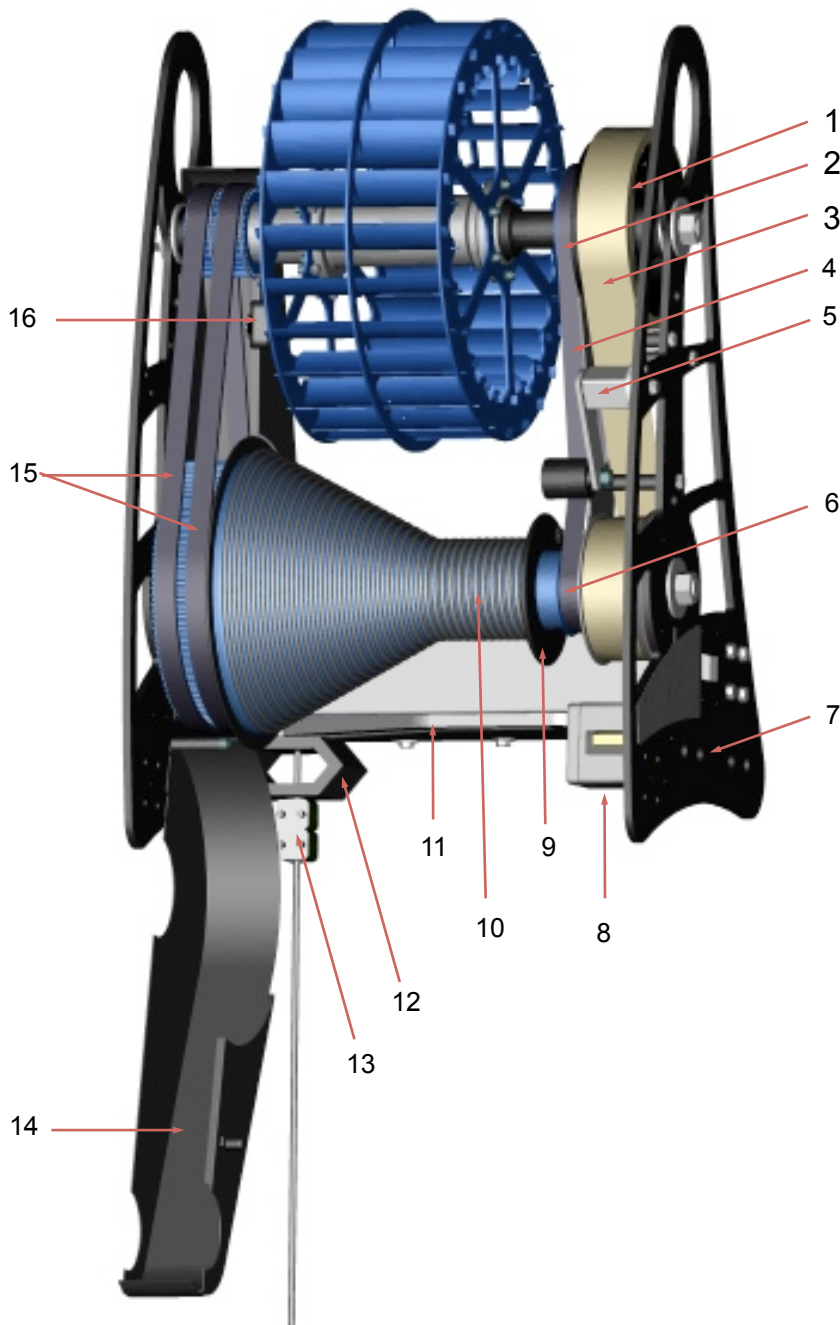
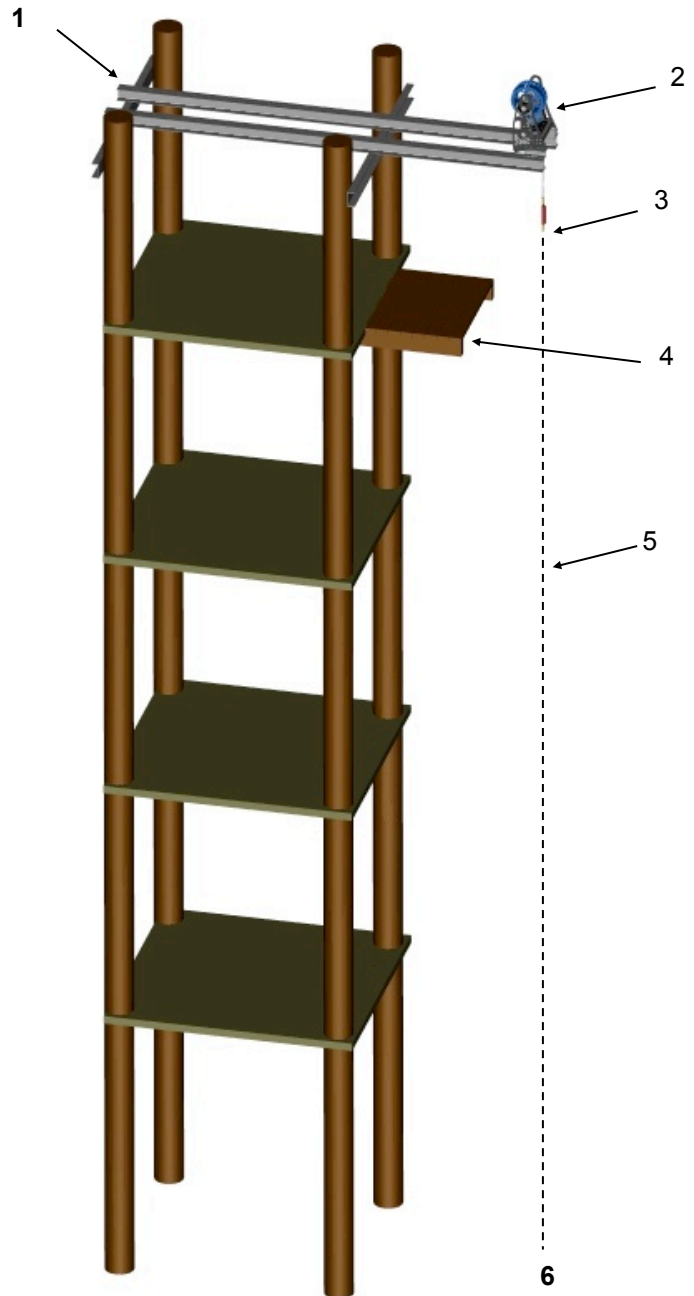

Figure 3: Powerfan® general mounting arrangement

1. Supporting structure  
(indicative only)
2. Powerfan
3. User attachment point
4. Step-off platform
5. Descent path
6. Landing area



## 3. Getting Started

### 3.1 Preparing your Powerfan® for use

On taking delivery of your Powerfan you will have received a package including the following items:

1. Powerfan® PF13
2. Stop screw
3. Drope™
4. Shock absorbing lanyard
5. Maillon
6. Carabiner
7. Rubber stop block
8. Clamp assembly, including rubber hose and cable ties
9. Rewind spring (already fitted on the Powerfan)
10. *Powerfan Operating Manual, Powerfan PF13 Inspection and Maintenance Manual.*

Please check that all the above items are present. Should anything be missing, you will not be able to set up your Powerfan for safe use.

The sequence of instructions set out below describes the initial setup of the Powerfan in preparation for first use. Note that this procedure refers to other, more detailed procedures that can be found elsewhere in this manual.

#### **Step 1**

Remove the Powerfan from its crate.

This crate should be stored carefully and used again should it be necessary to transport the Powerfan at a future date, for example for the two yearly service carried out by Dropzone.

#### **Step 2**

Mount the Powerfan on a supporting structure according to the instructions in the *Powerfan Installation Specification*.

### Step 3

On first receiving your Powerfan the rewind belt will not be fitted to the upper or lower rewind pulleys and the rewind spring will be in the position shown in figure 4.

Fit the rewind belt to the upper and lower rewind pulleys and tension the rewind belt. Further details of this procedure are given in steps 5 & 6 found in section 5.3.

Wind two full turns of spring onto the upper spring drum by manually turning the fan, as described in step 3 found in section 6.2.

Insert the stop screw to lock the upper spring drum into position. Further details of this procedure are given in step 2 found in section 5.1.

Before proceeding to fit the Drope, release the rewind belt from the tensioner and remove the rewind belt from the lower rewind pulley.

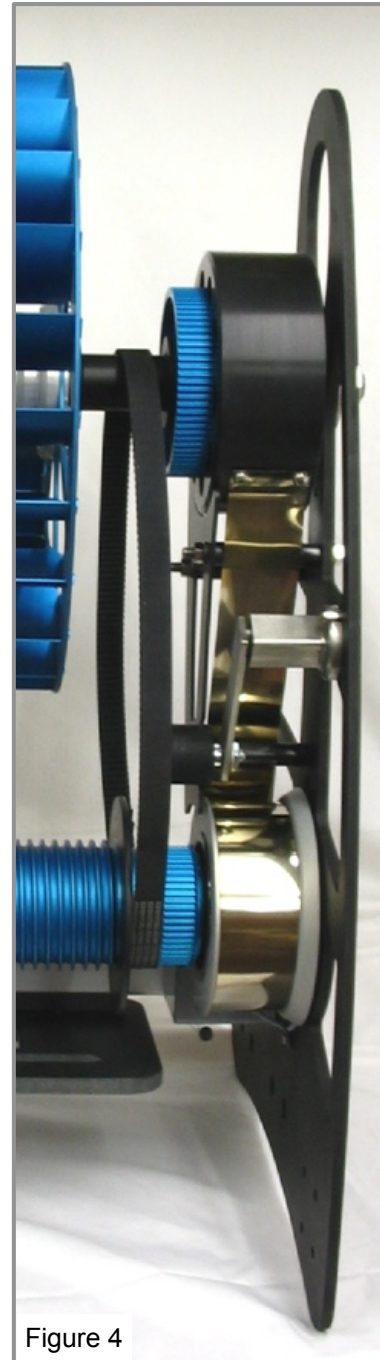

Figure 4



The POWERFAN® should now appear as in figure 5 opposite, with two turns of spring on the upper spring drum, the rewind belt released from the tensioner and removed from the lower rewind pulley and the upper spring drum locked off with the stop screw.

**Step 4**

Prepare the Drope™ according to the instructions in section 5.2.

**Step 5**

Fit the Drope™ to the rope drum according to the instructions in section 5.4.

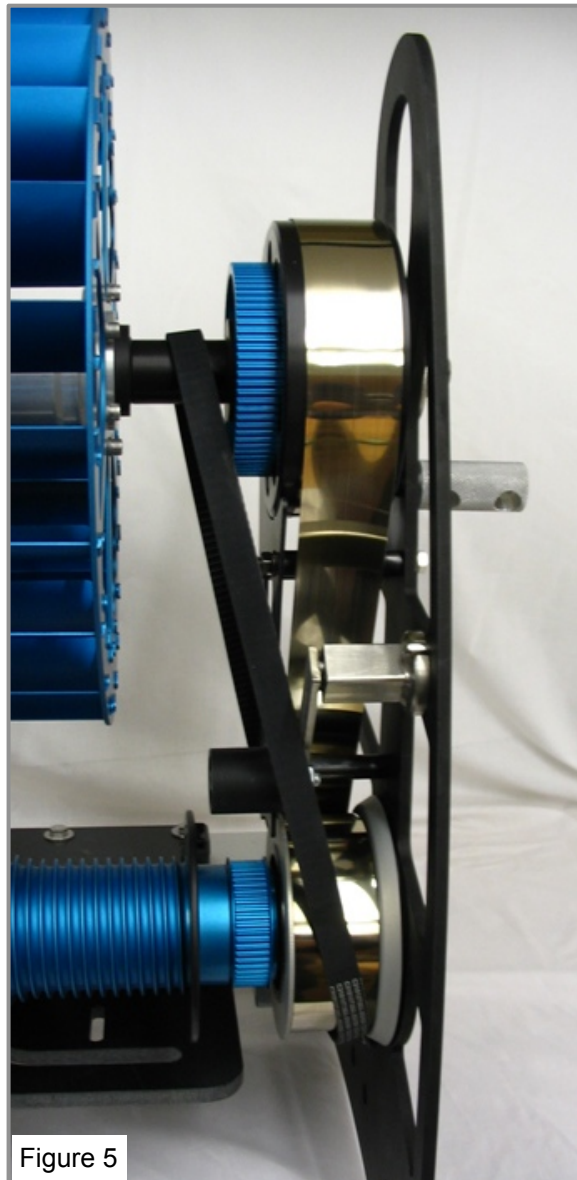

Figure 5

End of POWERFAN® setup instructions.

## 4. Inspection and Maintenance Schedule

### 4.1 Preparing your Powerfan PF13 for use

Before use each day the Powerfan must be inspected as follows:

Before starting make a note of the counter number.

Conduct a visual inspection of the Drope by slowly unreeling the Drope off the rope drum as far as it will go, whilst subjecting the Drope to a careful visual inspection. Note that it is important to inspect that part of the Drope™ that lies in the vicinity of the small flange as this can be a wear site. Refer to section 4.3 to determine whether or not the Drope must be retired.

Conduct a visual inspection of the rewind spring. This is done by reeling the Drope off the rope drum as described in the preceding paragraph. At no stage should it be necessary to touch the rewind spring. It is important that you do not attempt to pull the spring off the spring drums by hand. Refer to section 4.4 in order to determine whether the spring must be retired. Note that the spring must be inspected over its full working length. This corresponds to that portion of the spring that is revealed during the Drope inspection process above.

After performing the inspections of the Drope and the spring, recheck the counter number. The counter number should have increased by one for each time the Drope was reeled off the drum fully during the previous inspections. If this is not the case then the counter is not functioning. It is important that the counter functions properly as it is used to determine service and replacement intervals.

In addition to the inspection of the Drope and spring as described above, the operator of the Powerfan must also inspect the machine on a daily basis for any of the following defects:

- any signs of damage or excessive wear to the drive belts
- foreign objects or debris anywhere in or on the Powerfan
- ice or snow anywhere in or on the Powerfan
- loose bolts, screws or nuts anywhere on the Powerfan
- any signs of excessive corrosion or cracking anywhere on the Powerfan
- any signs of damage or deformation anywhere on the Powerfan.

### 4.2 Factory service

Your Powerfan should be returned to Dropzone for a detailed inspection and service after every two years or after every 250,000 descents, whichever occurs soonest.

### 4.3 When to retire a Drope

The Drope should be retired

- either after a maximum of 20,000 descents have been made since the Drope was installed,
- or after 1 year has elapsed since the Drope was installed,
- or after the sheath of the Drope has worn to the extent that the core is exposed,

whichever occurs soonest.

### 4.4 When to retire a rewind spring

The rewind spring should be retired:

- either after a maximum of 17,000 descents have been made since the spring was installed,
- or after 1 year has elapsed since the spring was installed,
- or after the first signs of spring fatigue have been detected during visual inspection (see figures 6 to 9 on the following pages),

whichever occurs soonest.



Figure 6. New spring showing absence of any defects visible to naked eye.

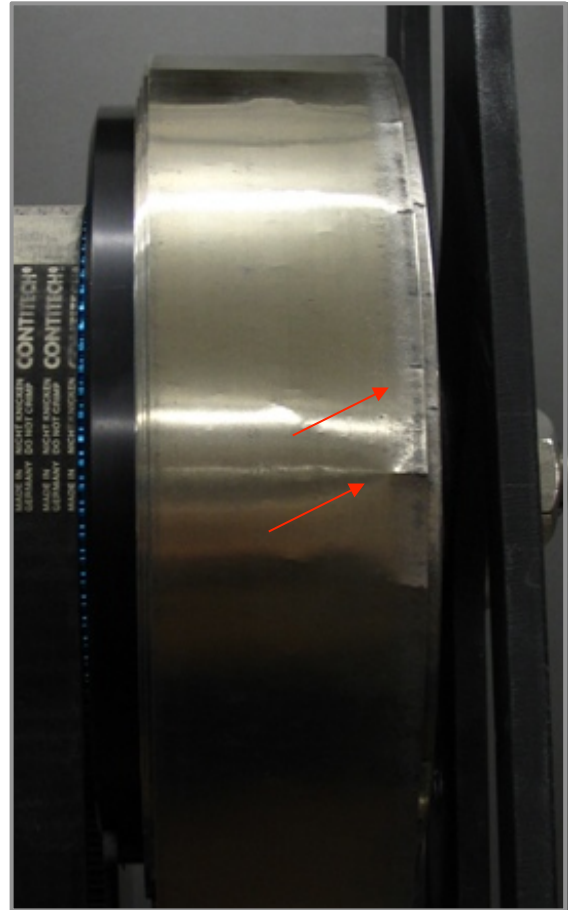

Figure 7. Used spring with clearly visible cracking. This spring should be retired immediately.

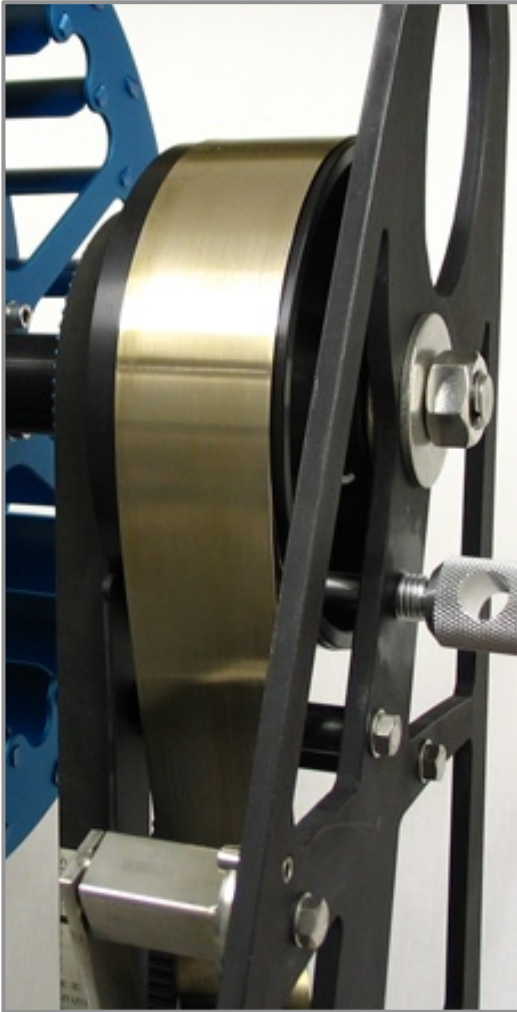

Figure 8. New spring

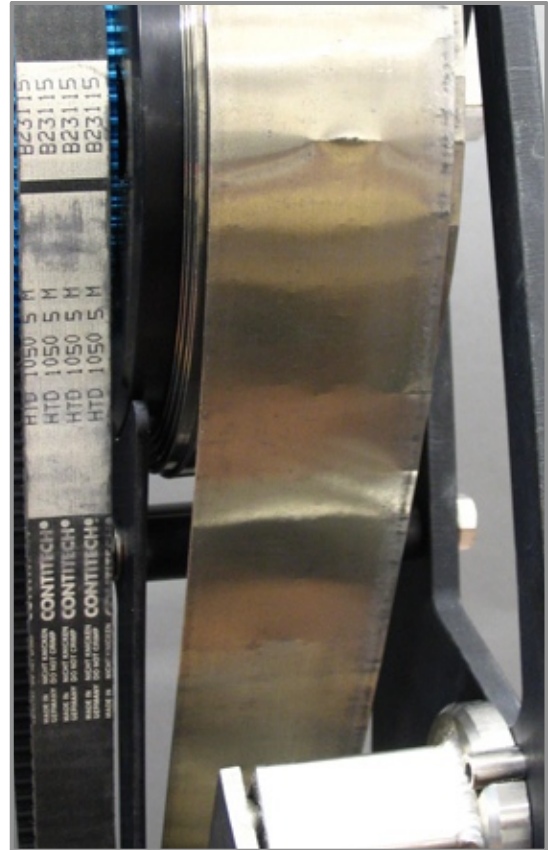

Figure 9. Used spring with clearly visible cracking. This spring should be retired immediately

## 5. Drope™ Replacement

Drope replacement should be recorded in the maintenance and inspection log book. Dropes must only be obtained from Dropzone.

### 5.1 Removal of a used Drope

#### **Step 1**

Allow the spring rewind to rewind the Drope fully so that the rubber stop block comes into contact with the lower guide plate.

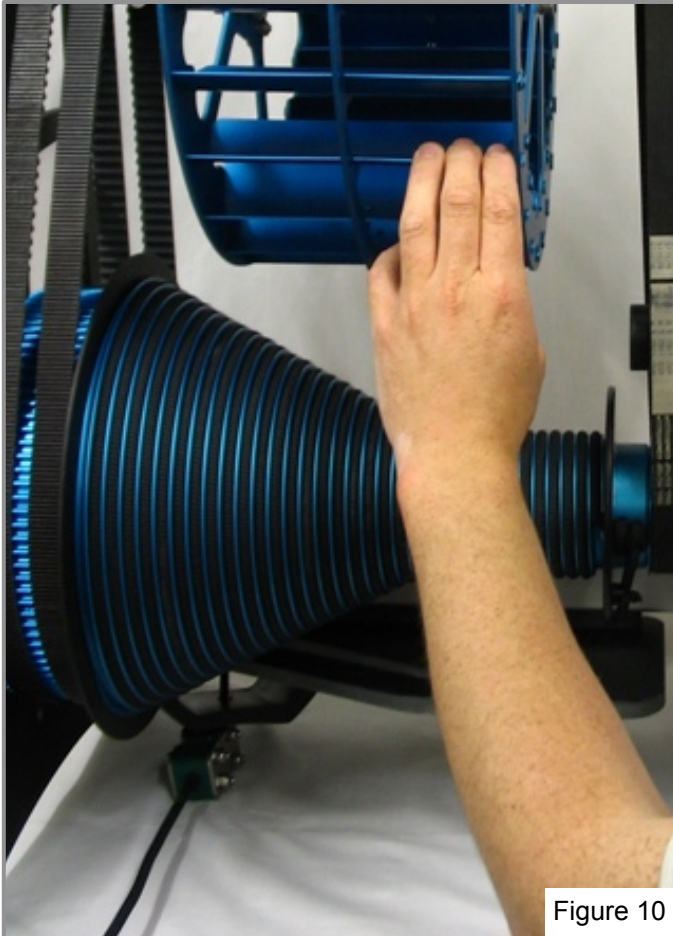
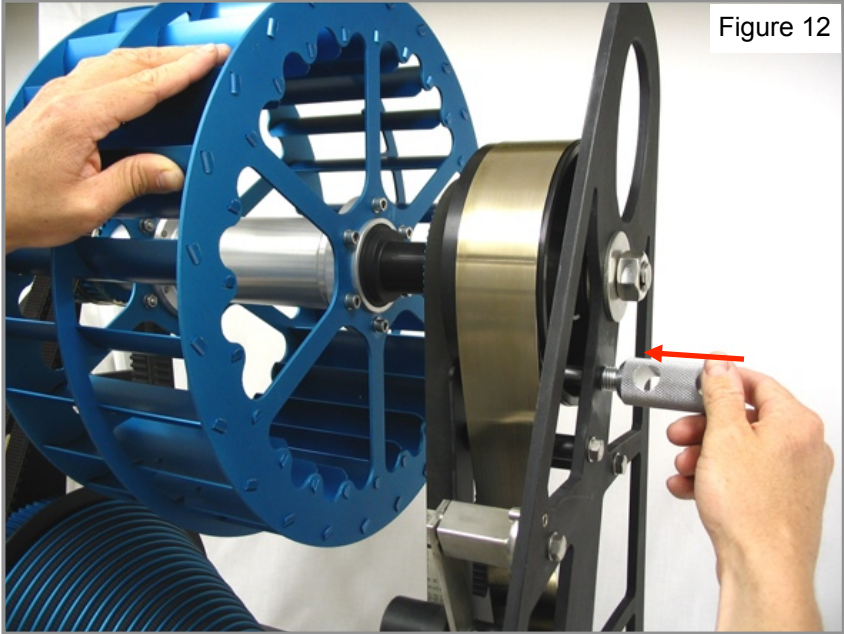
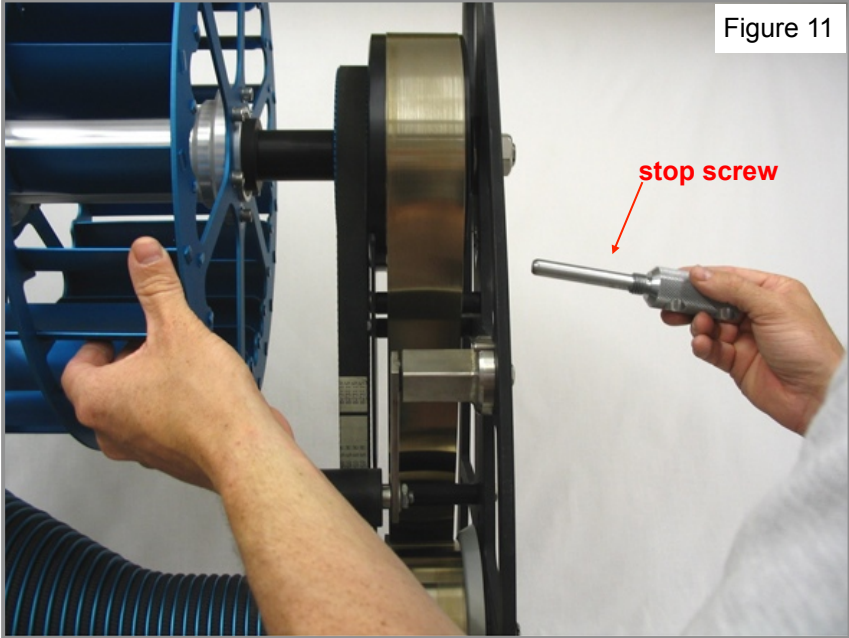

Figure 10

**Step 2**

Insert the stop screw into the threaded hole in the side plate in order to lock off the upper spring drum.



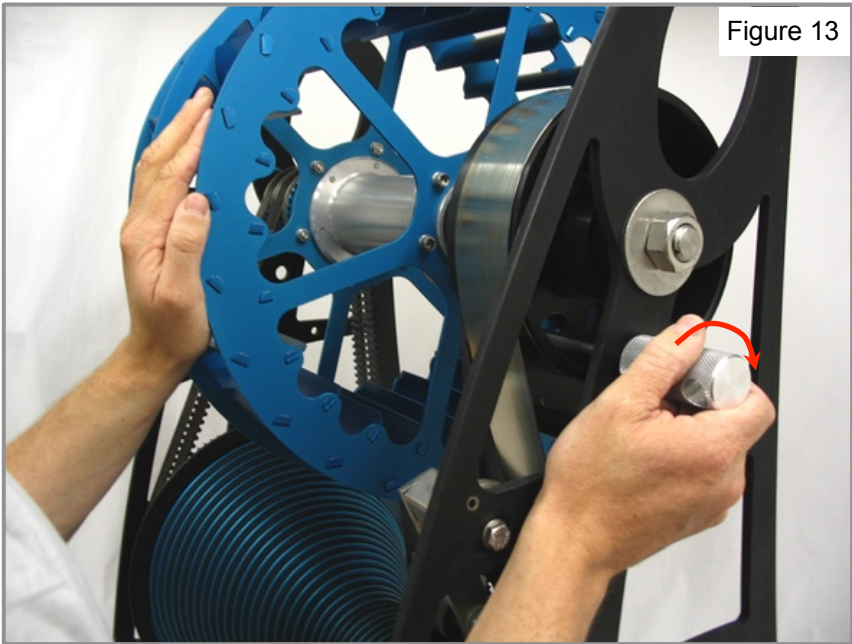

Figure 13

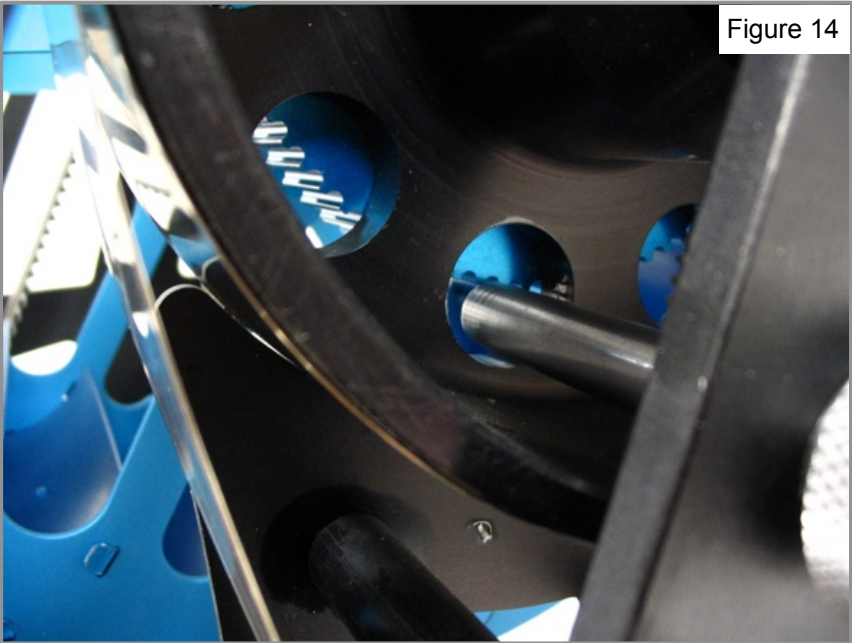

Figure 14



### Step 3

Isolate the rewind spring by releasing the tensioner from the rewind belt and by removing the rewind belt from the rewind pulleys.

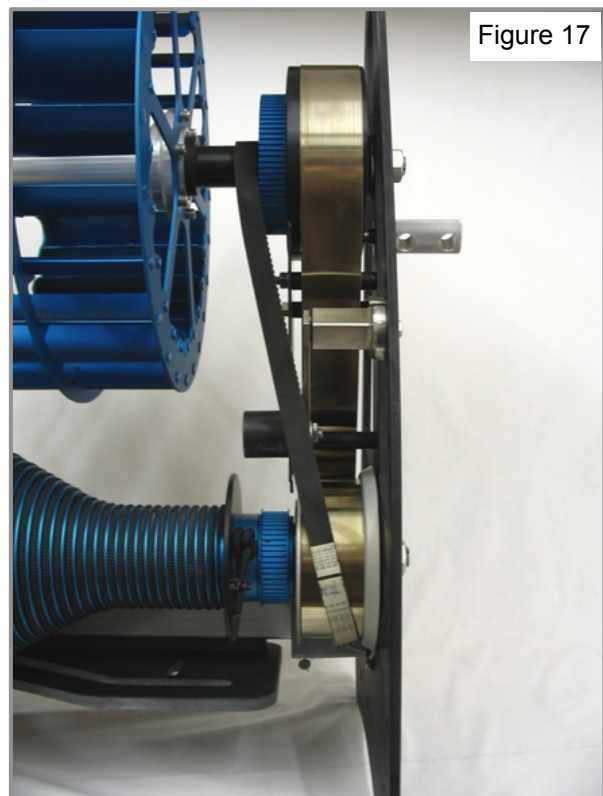





Figure 18

#### Step 4

Once the rewind spring has been isolated, pull the end of the Drope so that the Drope reels off the drum.

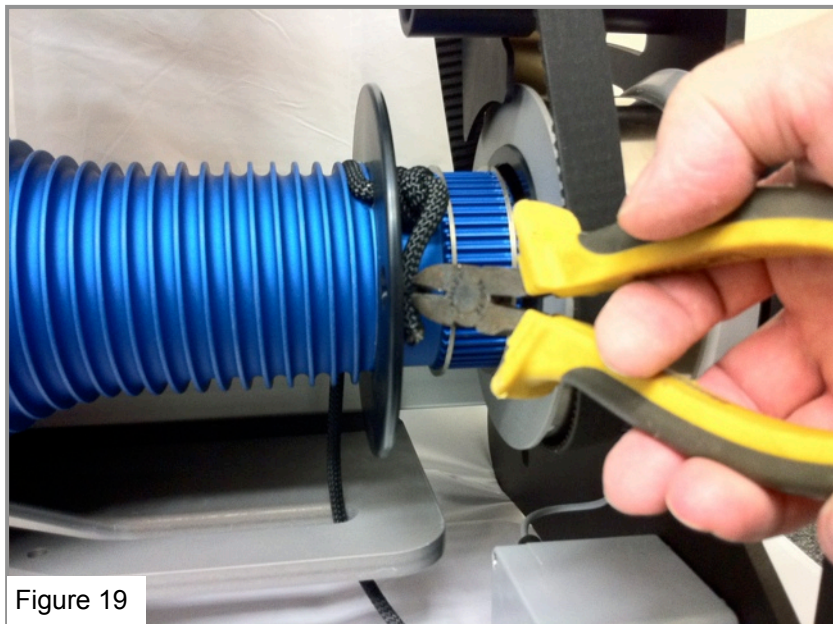

Figure 19

#### Step 5

Cut the cable tie and undo the stopper knot to release the Drope from drum (figure 19).

#### Step 6

Discard used Drope.

End of Drope removal instructions.

## 5.2 Preparation of a new Drope

This procedure must always be followed before fitting a new Drope to the Powerfan. Cutting the Drope to the correct length is of critical importance to the safe operation of the Powerfan. Note that you must cut the Drope in the correct place at the first attempt. Remember the proverb, "measure twice, cut once"! If you have any doubt, please do not hesitate to contact Dropzone.

### Step 1

Attach the carabiner to the shock absorbing lanyard. Connect the shock absorbing lanyard to the eye on the end of the Drope with the maillon as shown in figure 20.



Figure 20

### Step 2

Using a tape measure, carefully measure the vertical distance from the underside of the lower guide plate to the ground surface at the landing area. It is important that the measurement is accurate to the nearest centimetre. Make a note of this measurement. It will be needed in step 3. Note that since this distance may vary with time this step must be repeated every time a new Drope is fitted.

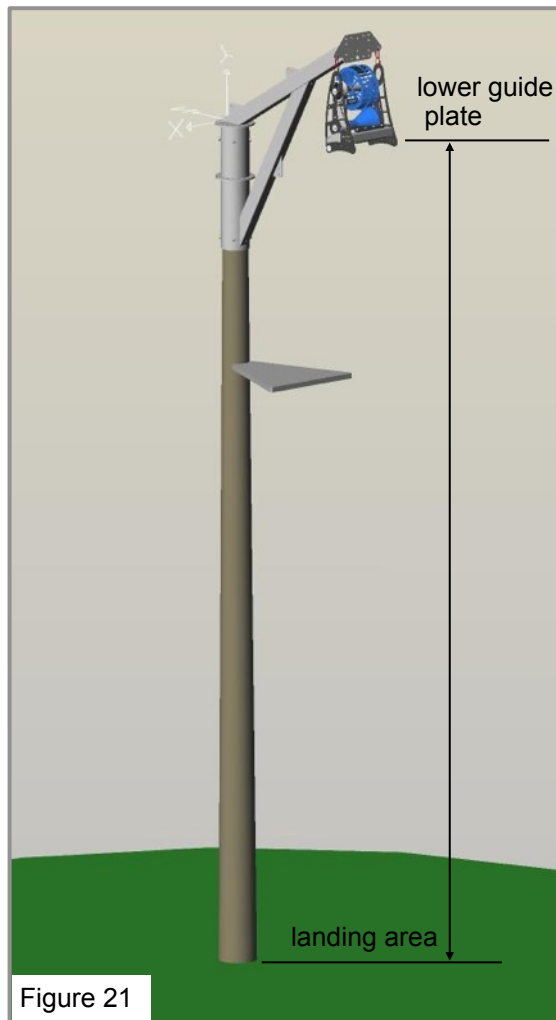
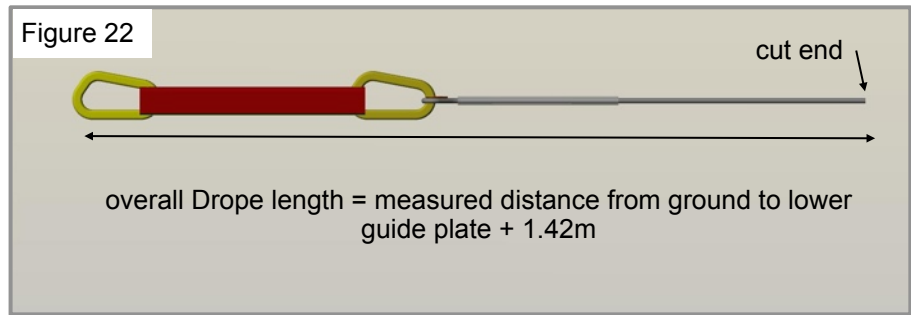

Figure 21

### Step 3

Once the measurement in step 2 has been obtained, the Drope should be cut according to the formula shown in figure 22 below. The Drope should be cut so that the overall length including the safety lanyard and carabiner is equal to the measured distance from the underside of the lower guide plate to the ground plus 1.42 metres.



**Tip:** Using a hot knife or rope cutter, cut the Drope at an angle as shown in figure 23. This will assist with feeding the Drope through the hole in the small flange.



Figure 23

### Step 4

Before fitting the new Drope onto the Powerfan, the rubber stop block should be threaded onto the Drope. The Drope clamps should then be positioned on the Drope as shown so that the distance from carabiner to the top of the rubber stop block is 1.36m. This will ensure that the participant attachment carabiner is reachable from the step-off platform when the Drope is fully rewound. If the distance from the step off platform to the lower guide plate is greater than 2.5m then the position of the Drope clamps should be adjusted accordingly.

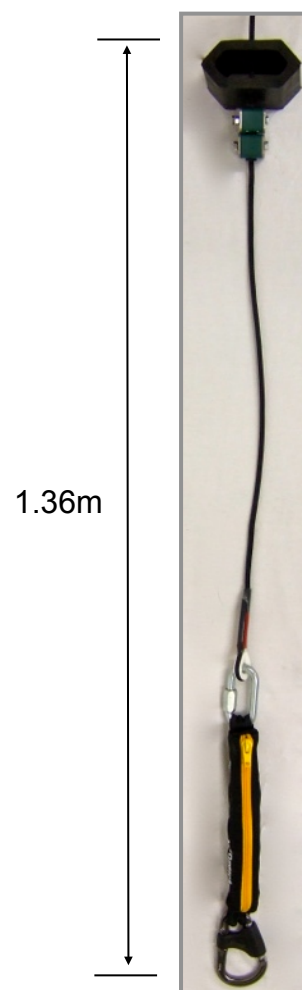

Figure 24

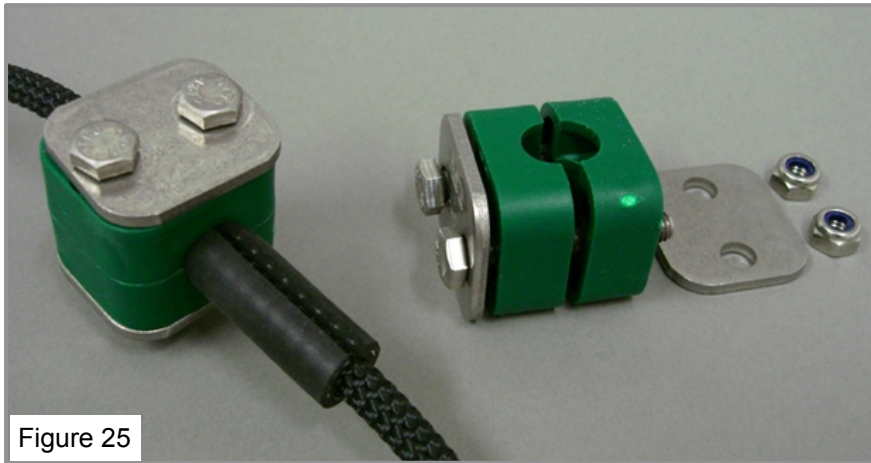

Figure 25

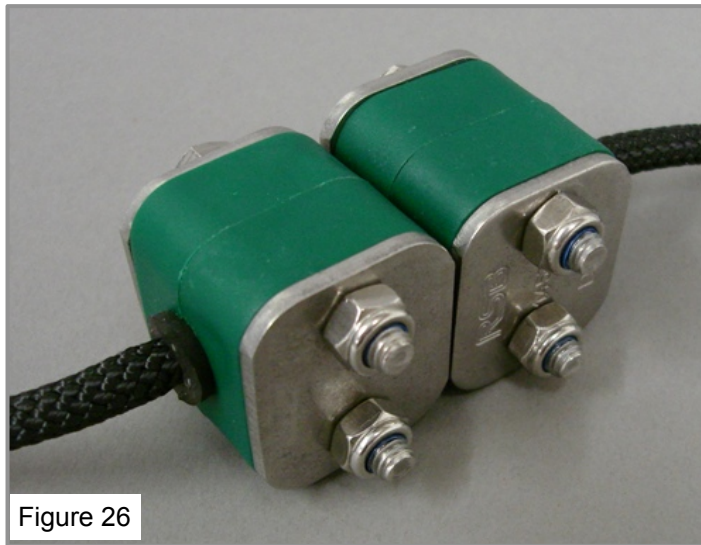

Figure 26

End of Drope preparation instructions.

### 5.3 Fitting a new Drope

Note that once the Drope has been cut to length according to the instructions in section 5.2, the Drope should not be subjected to further cutting or trimming during the fitting process described below. With the upper spring drum locked off using the stop screw and the spring rewind belt removed from the rewind pulleys (see section 5.1, step 2 and step 3), proceed as follows:

#### Step 1

Pass the end of the Drope up through the slot in the lower guide plate, up between the upper guide plate and the rope drum and through the hole in the small flange as shown in Figures 27 to 29. Pull approximately 300-400mm of Drope through the hole in the small flange.

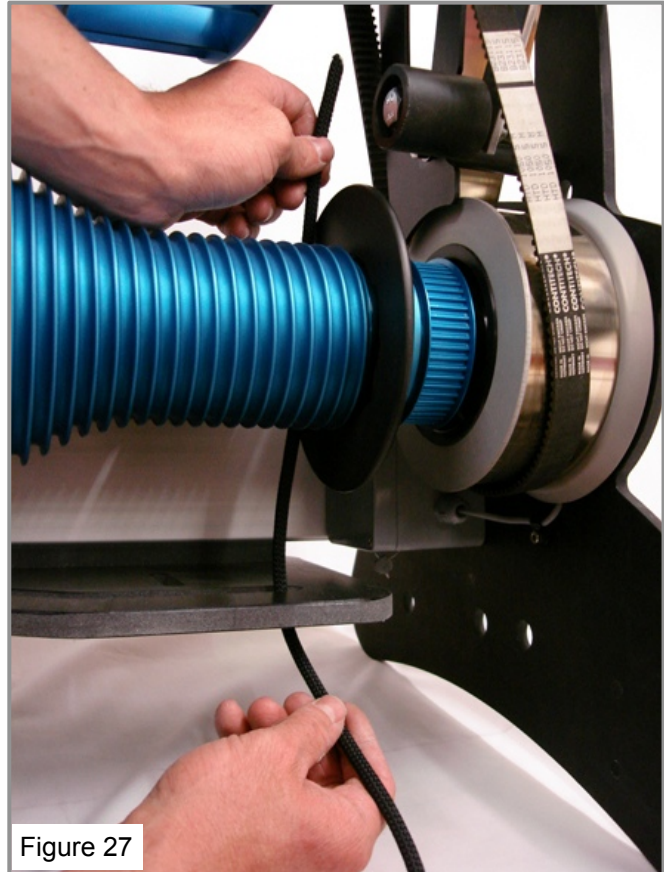

Figure 27

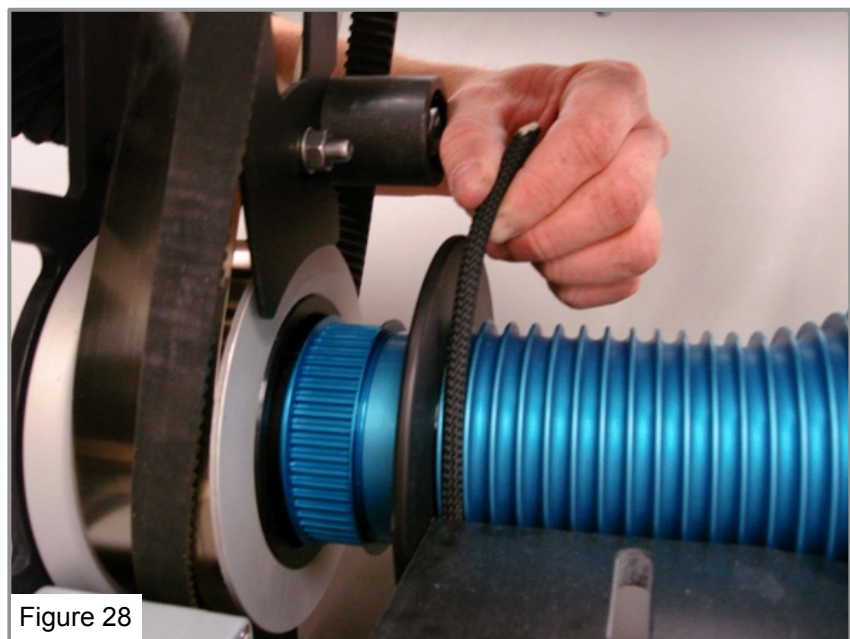

Figure 28

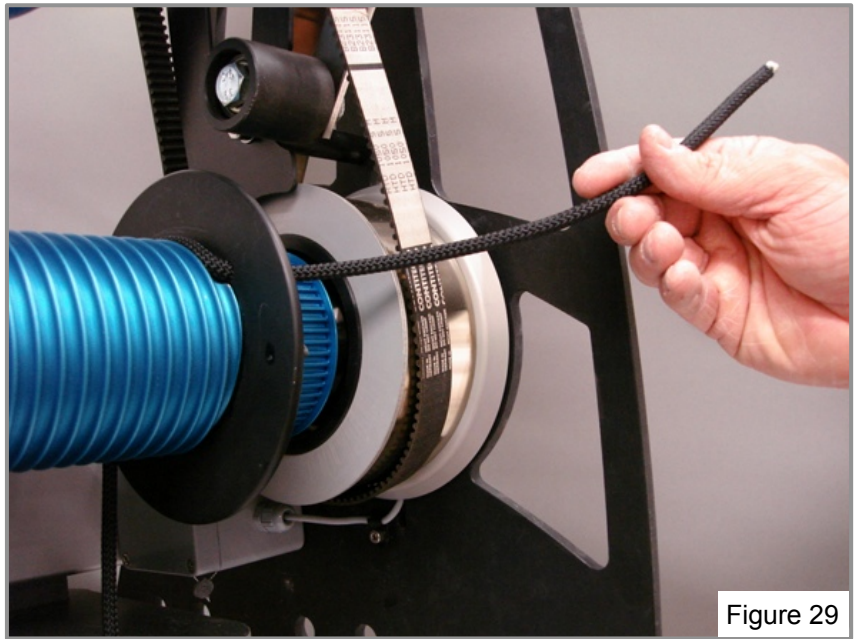

Figure 29

**Step 2**

Tie a double overhand stopper knot in the Drope leaving a tail of approximately 40-50mm. Pull the Drope back through the hole in the small flange so that the stopper knot sits hard up against the small flange.

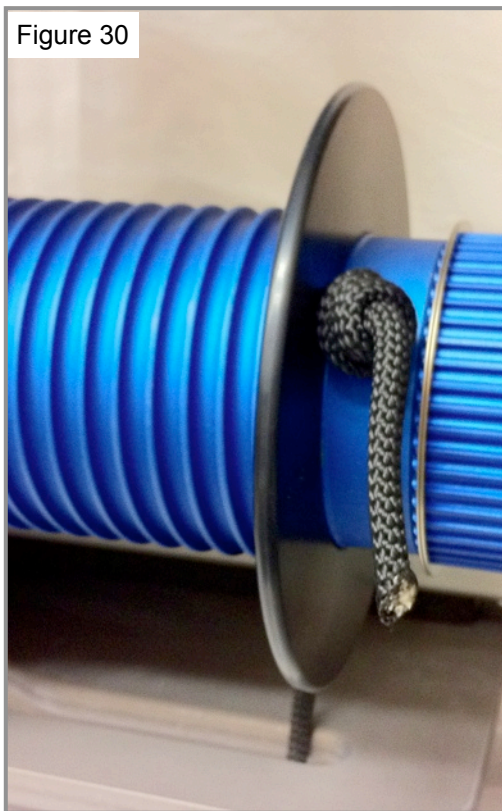
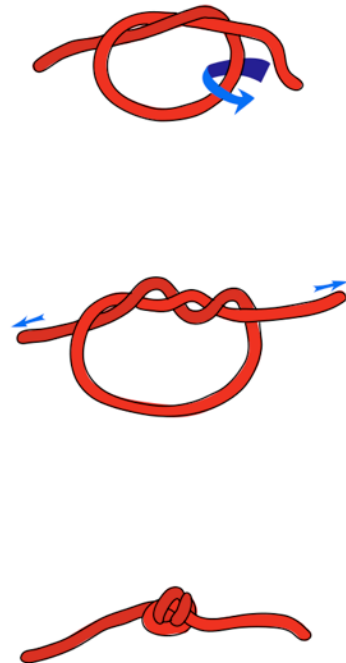

Figure 30

Figure 31:  
Double  
overhand  
stopper knot



### Step 3

Thread the cable tie through the two holes in the flange as shown in figure 32. Fasten the tail of the Drope to the small flange using a cable tie as shown in figure 33. Trim the excess cable tie. There should be approximately 10 to 15mm of Drope tail left projecting beyond the cable tie.

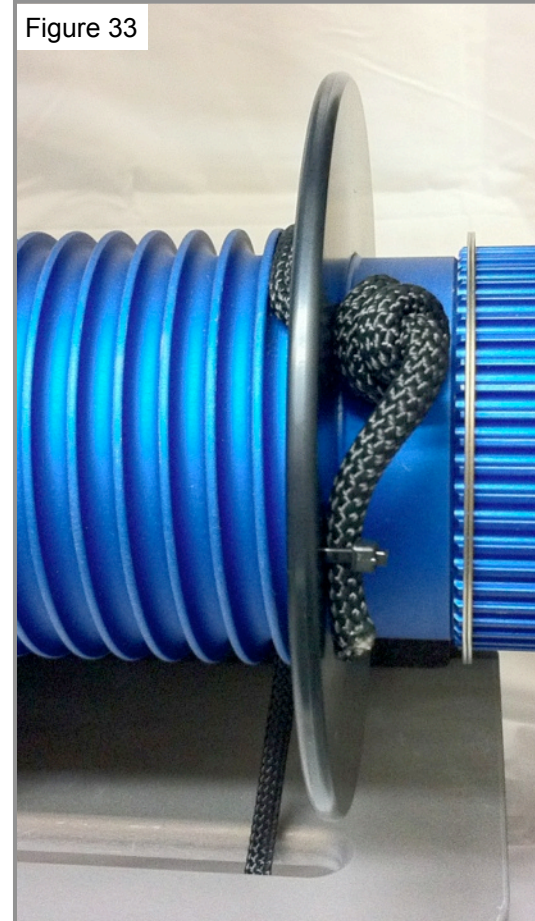

#### Step 4

Maintaining a little hand tension on the Drope wind the Drope onto the drum by rotating the fan by hand. Wind the Drope onto the drum until the rubber stop block comes into contact with the lower guide plate.

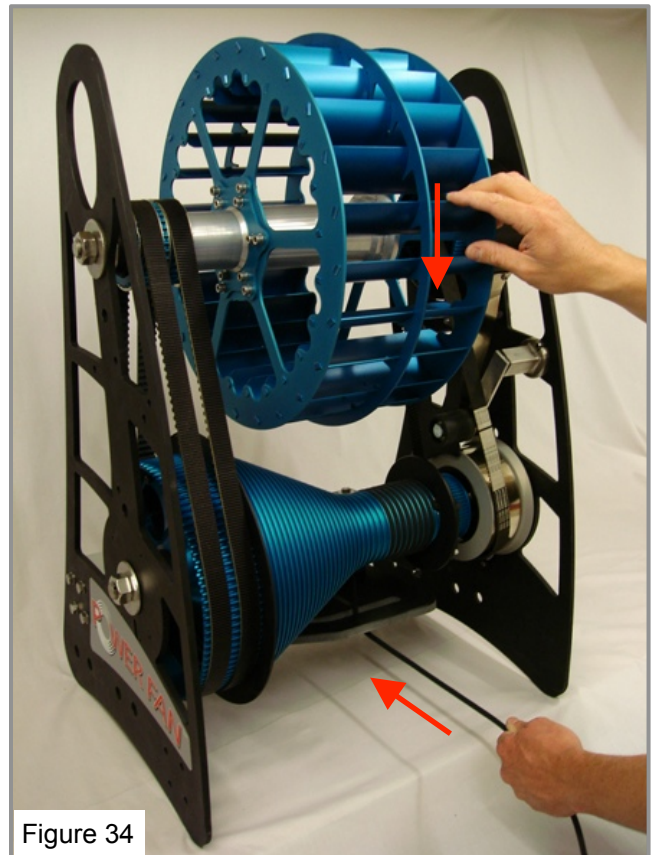

Figure 34

#### Step 5

Making sure that the rubber stop block is kept in contact with the lower guide plate, refit the rewind belt to the upper and lower rewind pulleys.

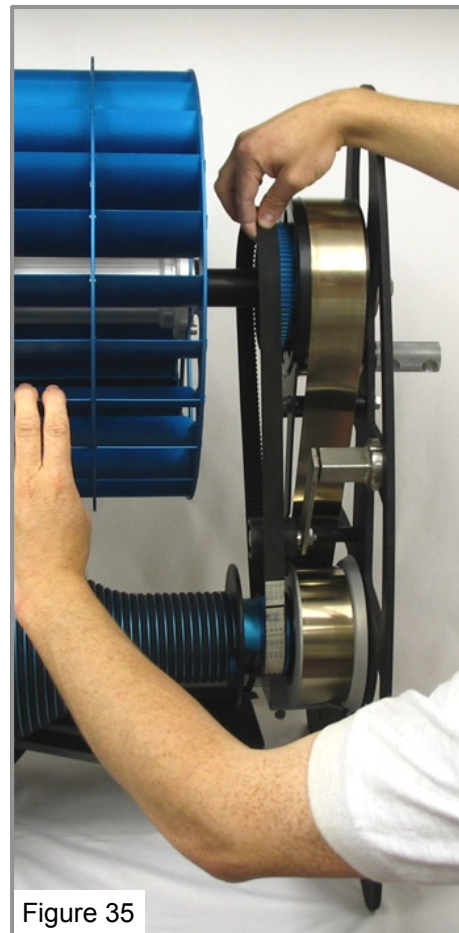

Figure 35



**Step 6**

Reposition the belt tensioner in front of the rewind belt so that the belt is tensioned.

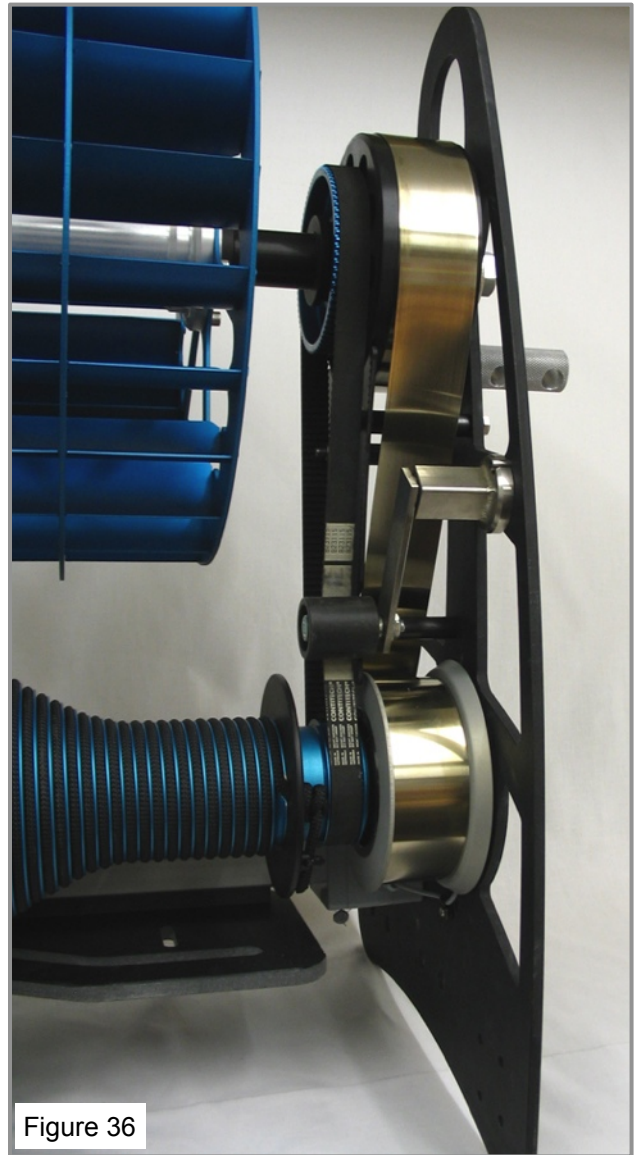

Figure 36

**Step 7**

Remove the stop screw from the upper spring drum.

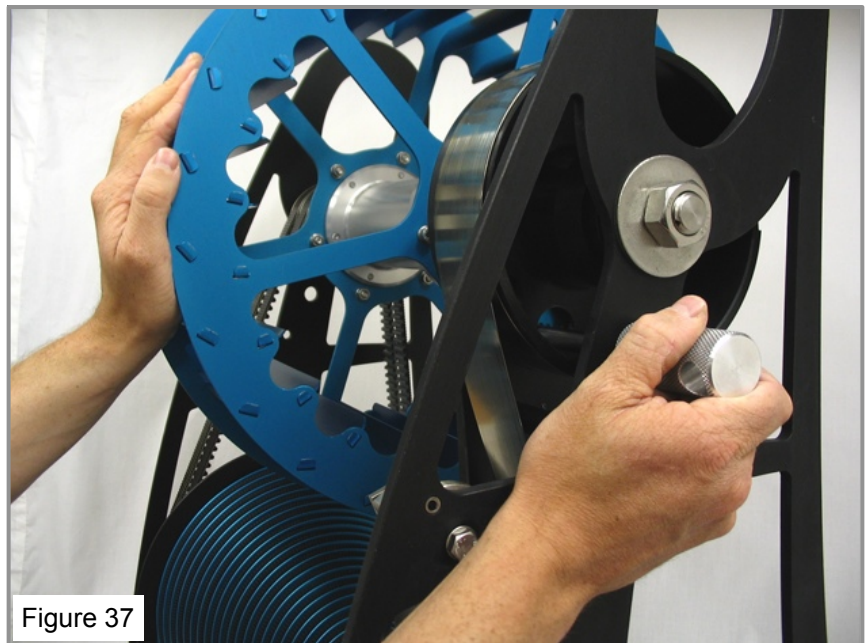

Figure 37

## Step 8

Check that the correct length of Drope has been fitted to the POWERFAN.

This is done by pulling the Drope off the rope drum until the attachment karabiner is touching the ground at the landing area and counting the remaining turns of Drope left on the rope drum. There should be four turns plus or minus one turn.

The Drope replacement process is now completed by reeling the Drope off the rope drum as far as possible and then allowing the spring to rewind the Drope whilst maintaining some tension on the Drope by hand. This ensures that the Drope seats properly into the grooves on the rope drum. Record the fact that the Drope was changed along with the counter number in the logbook.

End of instructions for fitting new Drope.

## 6. Spring Replacement

Spring replacement should be recorded in the maintenance and inspection log book. Springs must only be obtained from Dropzone.

### 6.1 Removing a used rewind spring

This section gives the procedure for the removal of a used spring that has not parted. In circumstances where the spring has parted, please contact Dropzone for advice.

**WARNING:** the rewind spring has sharp edges and requires careful handling. It is important to wear the correct personal protective equipment. If there is any doubt about handling the spring please contact Dropzone for advice.

### Step 1

Allow the spring rewind to rewind the Drope fully so that the rubber stop block comes into contact with the lower guide plate.

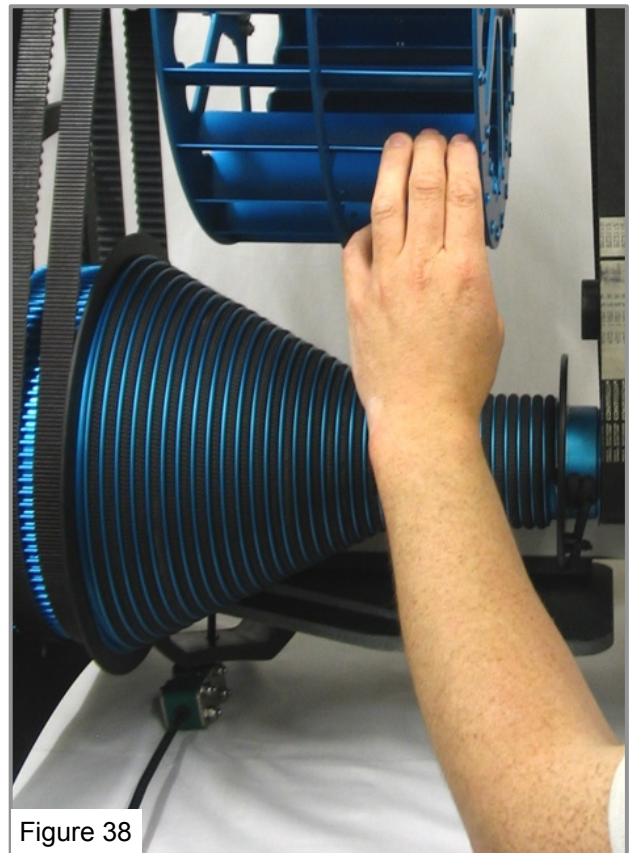

Figure 38

## Step 2

Insert stop screw, release the tensioner from the rewind belt, and remove the rewind belt from the rewind pulleys. (Figures 39 to 45)

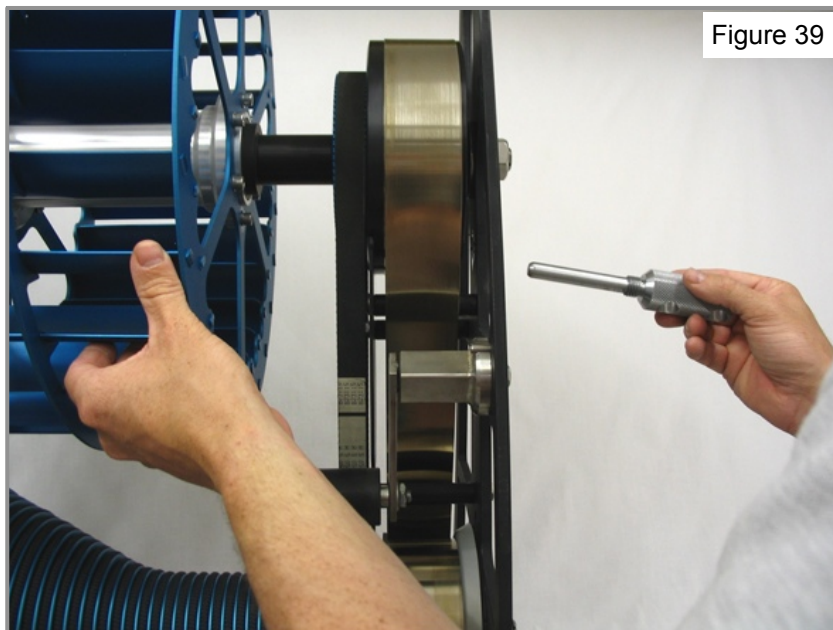

Figure 39

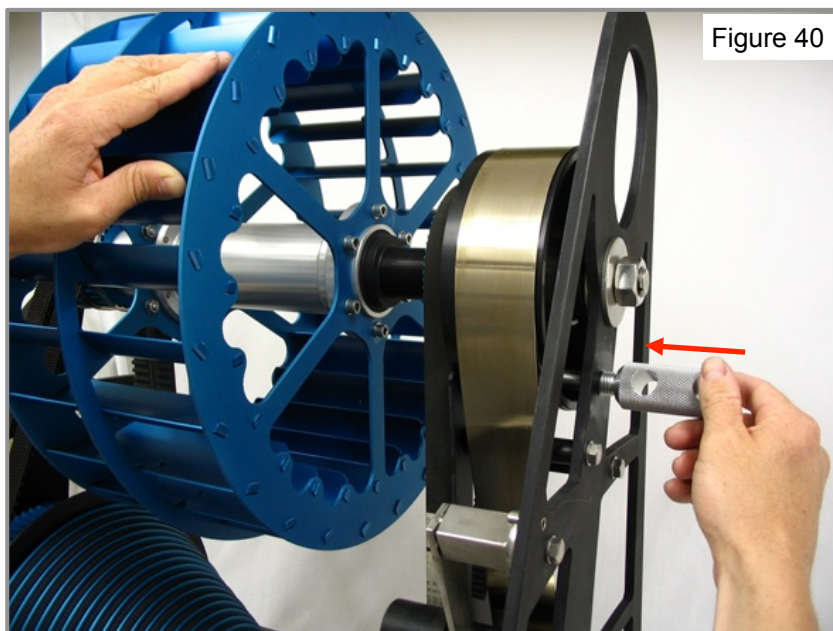

Figure 40

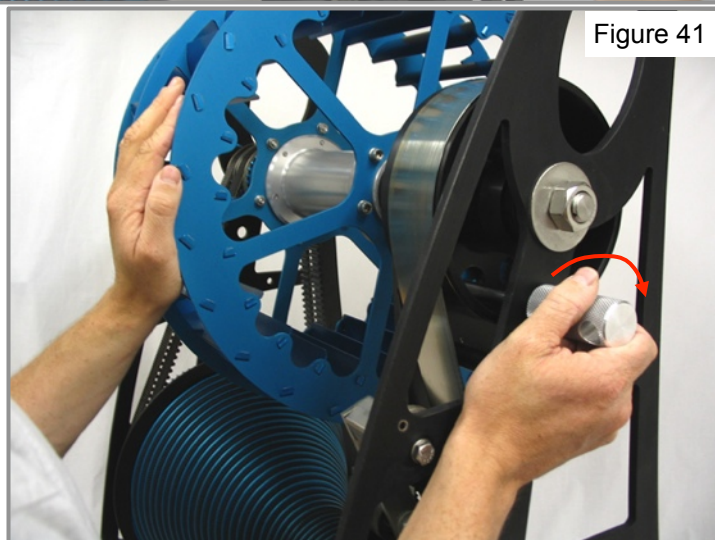

Figure 41

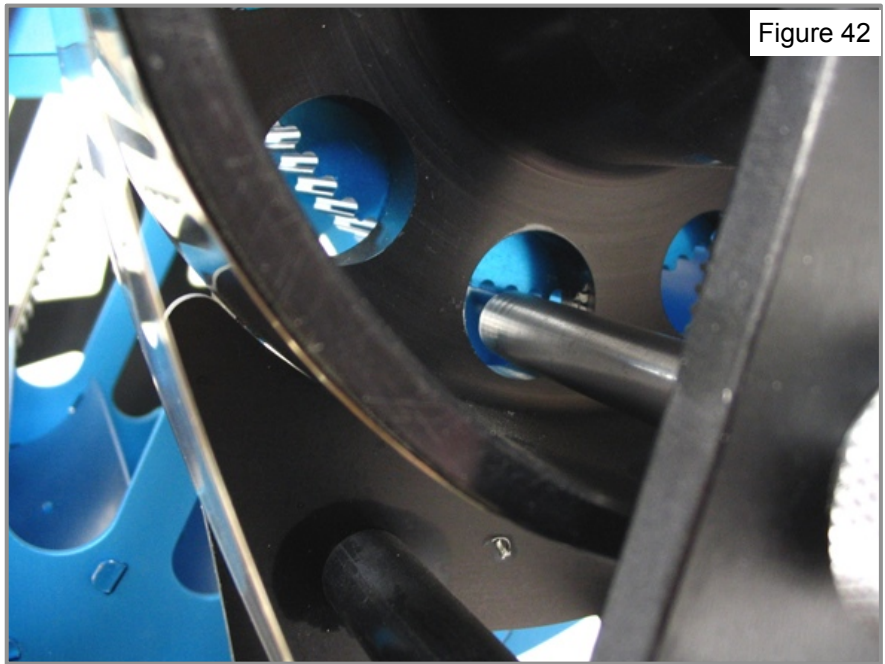

Figure 42



Figure 43

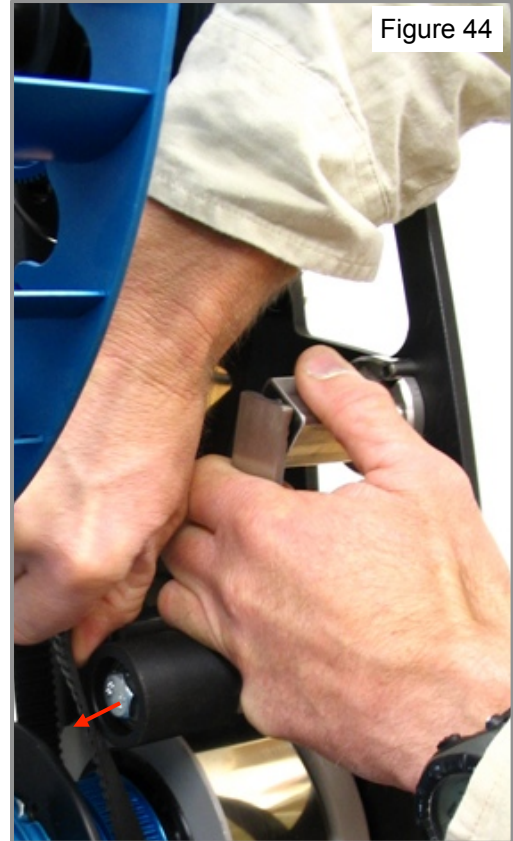

Figure 44

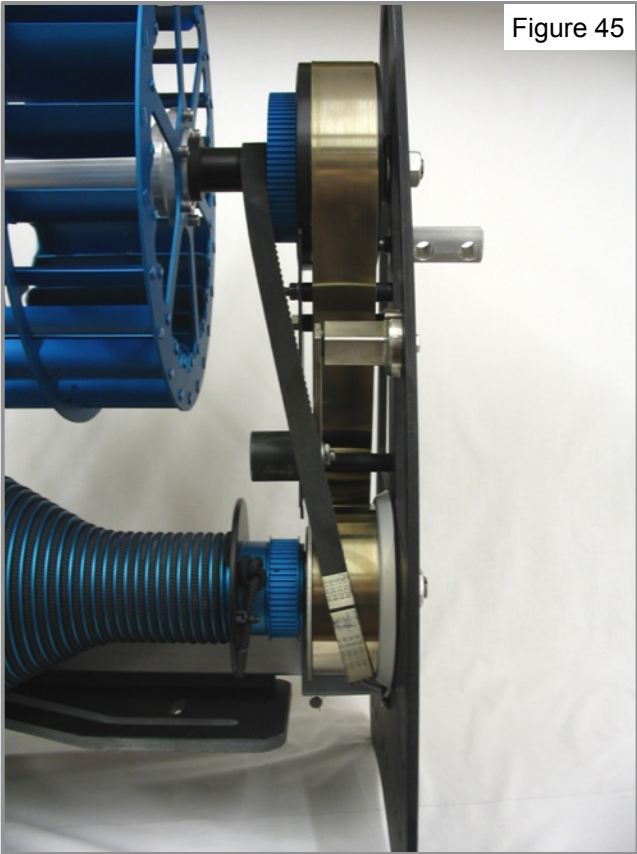

Figure 45

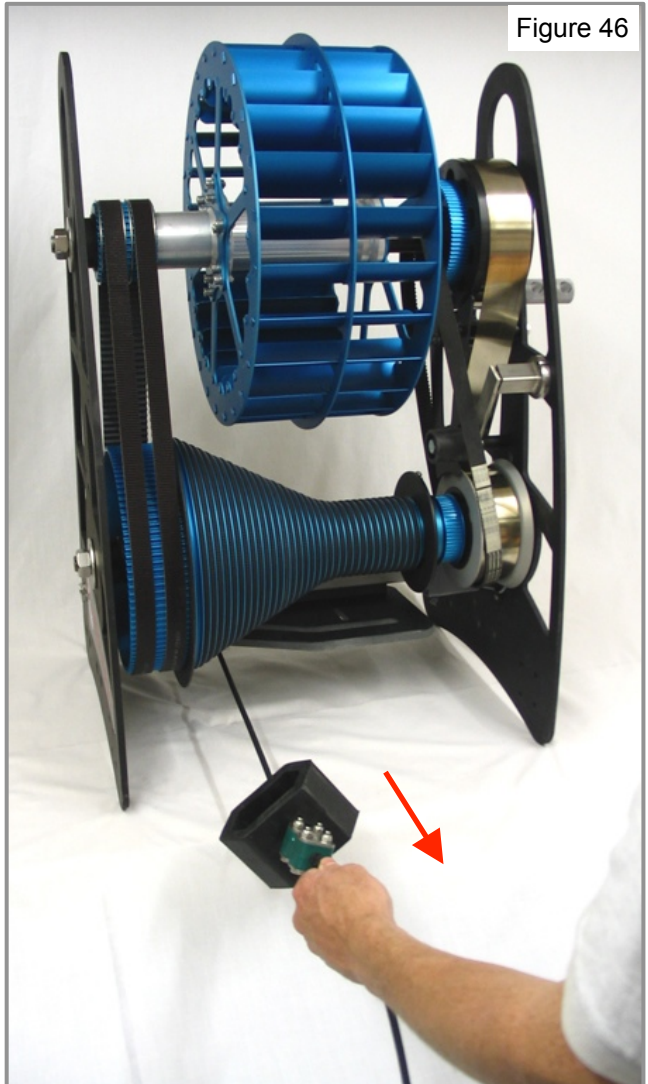

Figure 46

**Step 3**

Now that the rewind has been isolated from the rope drum, pull approximately 5 metres of Drope from the rope drum.

#### Step 4

Making sure that there is approximately 5 metres of Drope between the rubber stop block and the lower guide plate, refit the rewind belt to the upper and lower rewind pulleys and reposition the belt tensioner in front of the rewind belt.

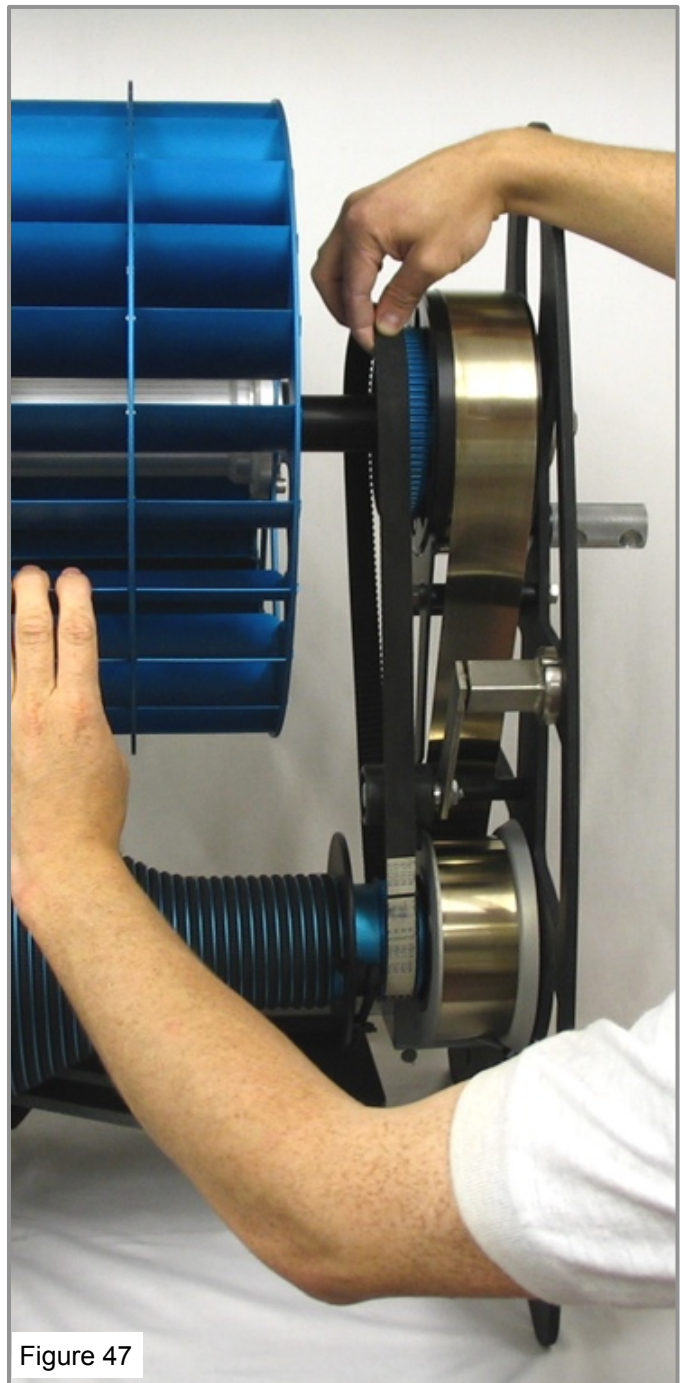

Figure 47

### Step 5

Take hold of the Drope firmly (without pulling on it) and remove the stop screw from the upper spring drum whilst continuing to hold the Drope firmly. You should feel a gentle tension come onto the Drope from the rewind spring as the stop screw is removed. After the stop screw is removed, allow the Drope to be rewound onto the drum slowly until you see that the spring is unable to rewind further from the upper spring drum. Once the upper spring drum is in the position shown in figure 49, you can release your grip on the Drope.

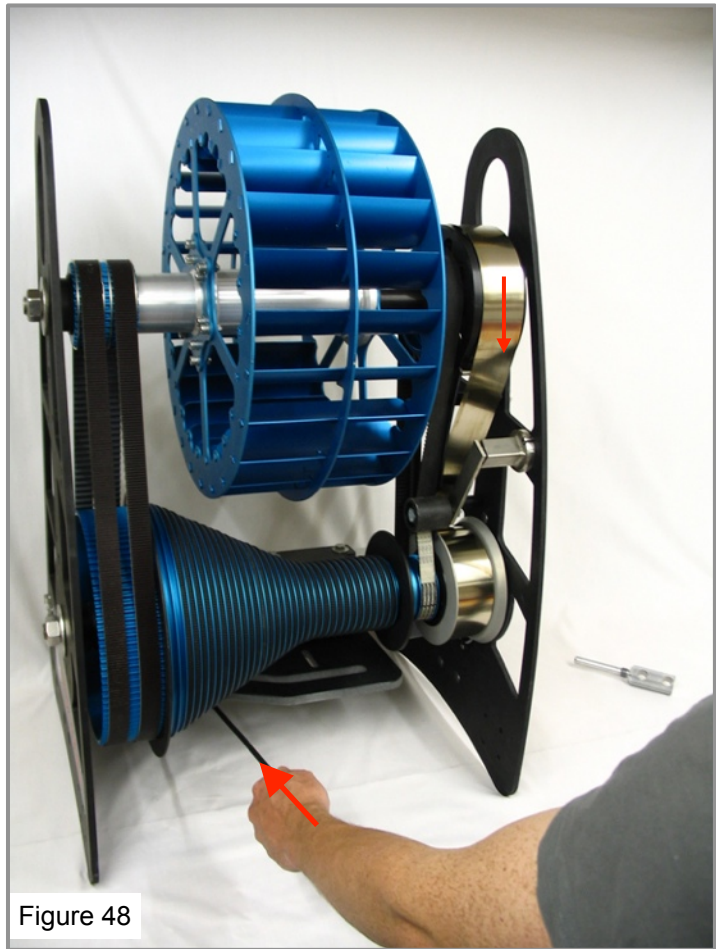



Figure 50

**Step 6**

Using a 4mm hex key, unscrew the spring from the upper spring drum.



Figure 51

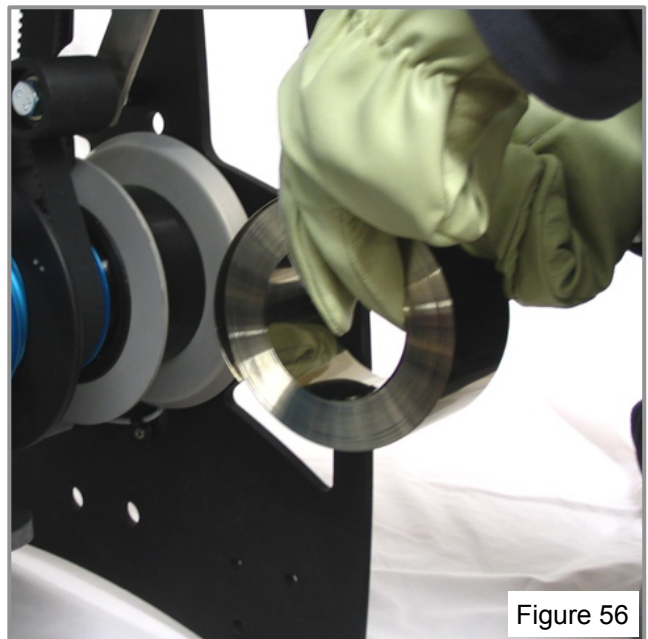
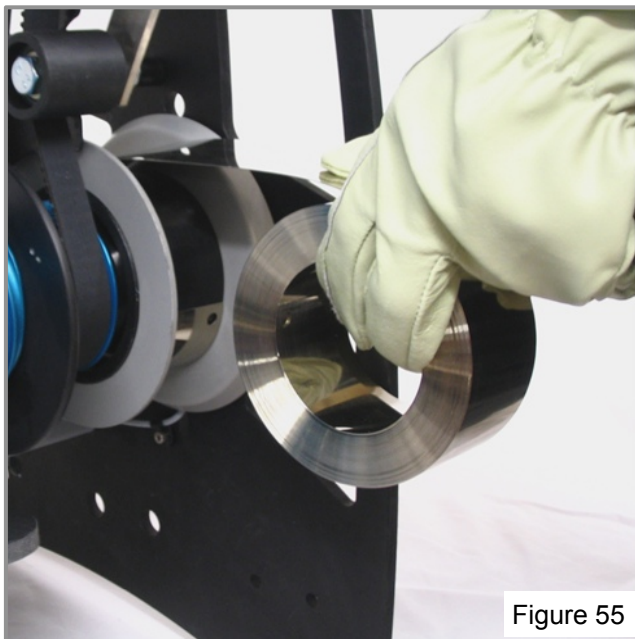
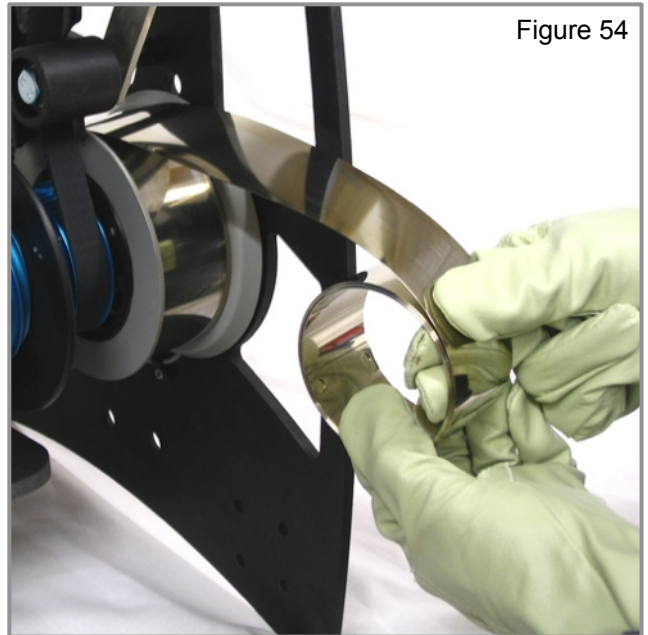
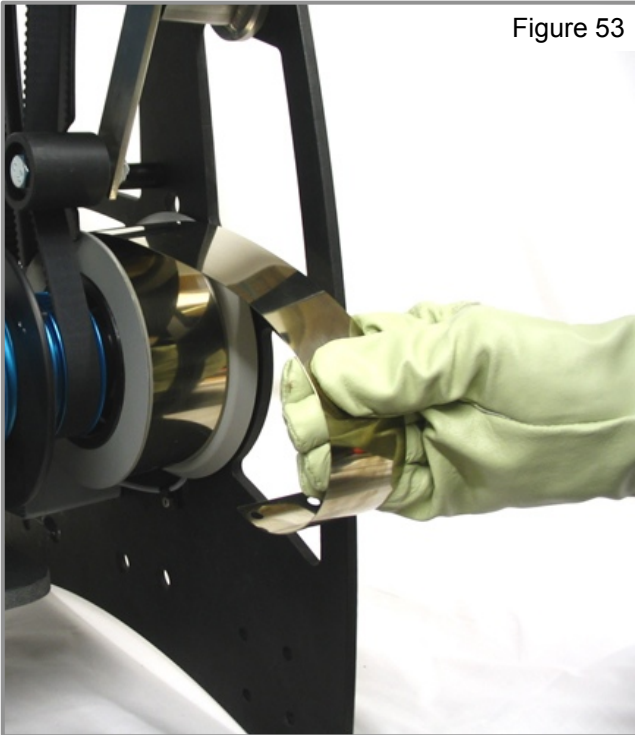

Figure 52



**Step 7**

Remove the used spring from the lower spring drum as shown in figures 53 to 56.



**Step 8**

Discard used spring.

End of spring removal instructions.

## 6.2 Fitting a new rewind spring

This section gives the procedure for fitting a replacement spring. Replacement springs must be obtained from Dropzone.

### Step 1

Feed the spring onto the lower spring drum as shown in figure 57.



**Step 2**

Attach the end of the spring to the upper spring drum using screws as shown in figures 58 to 62.

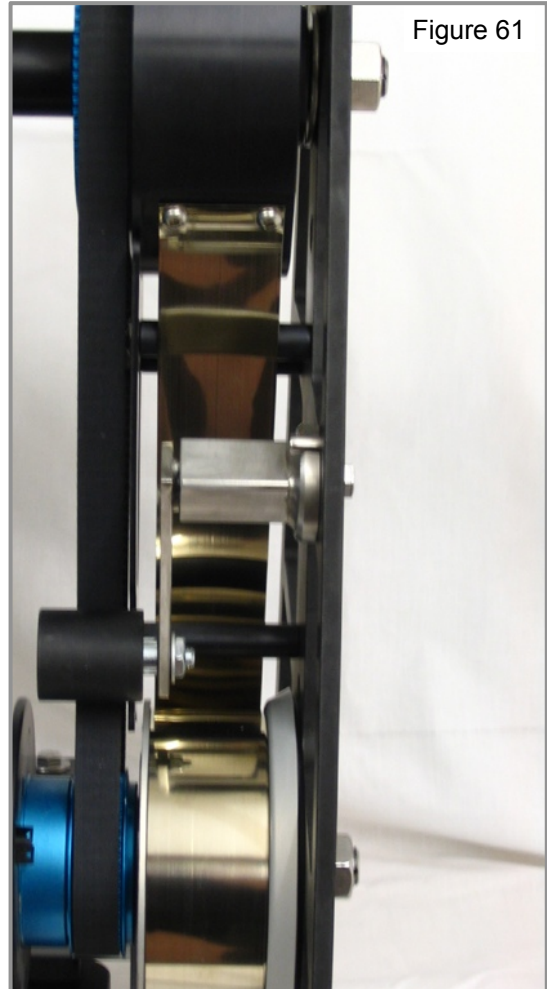
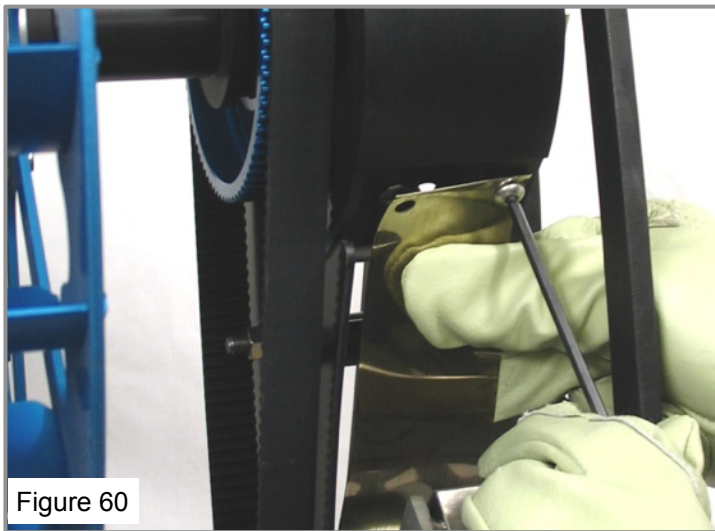
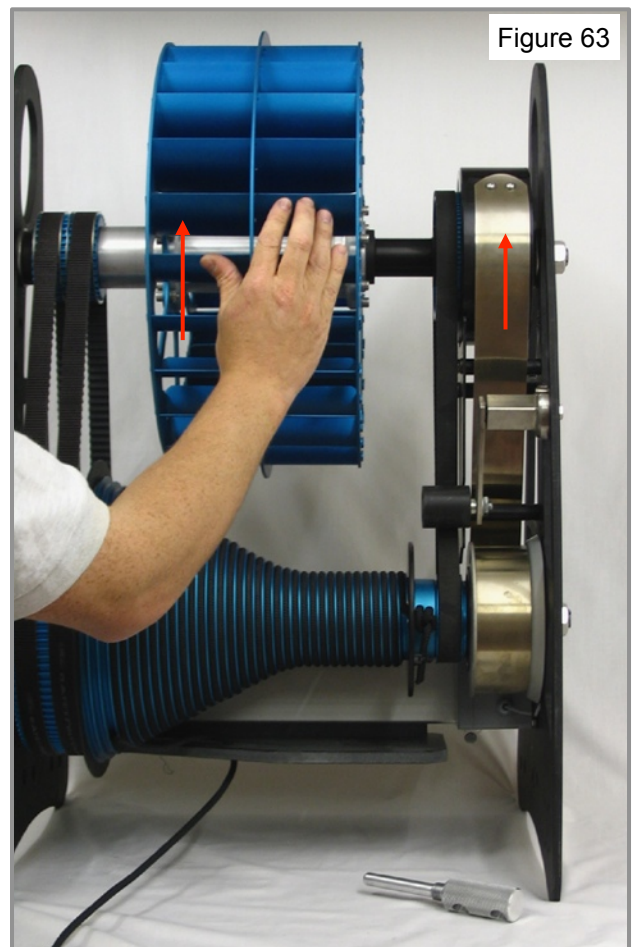

Figure 62



Figure 63



**Step 3**

By rotating the fan by hand in the direction shown, wind two turns of the new spring onto the upper spring drum.

#### Step 4

Keeping hold of the fan with one hand, lock off the upper spring drum with the stop screw.

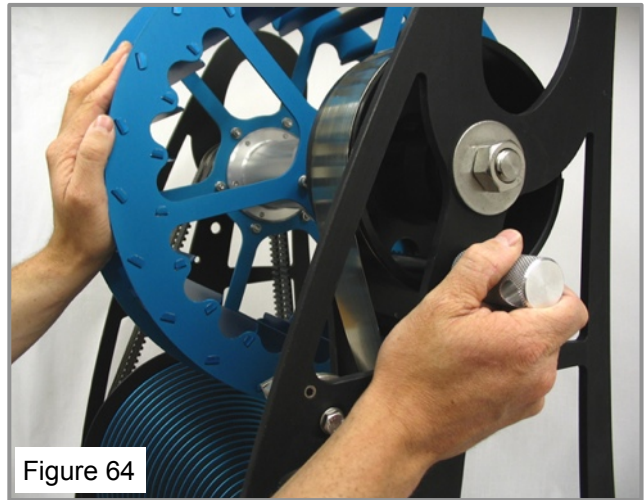

#### Step 5

Remove the rewind belt from the pulleys.



#### Step 6

Wind the Drope onto the drum so that the rubber stop block is touching the lower guide plate.

**Step 7**

Refit the rewind belt while keeping the fan stationary.

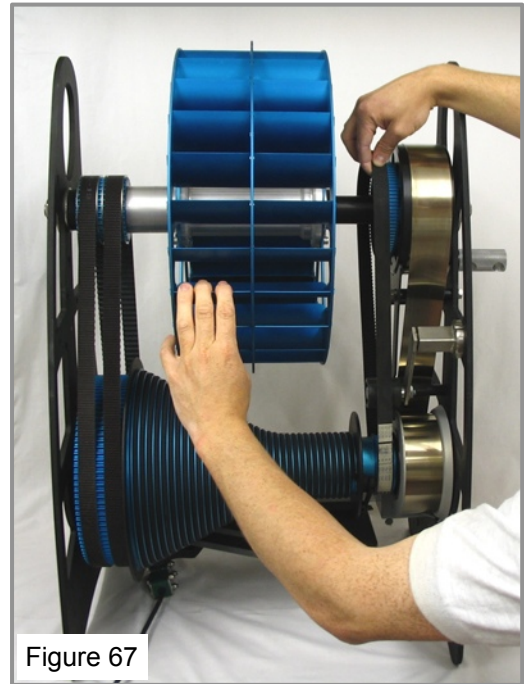

**Step 8**

Remove the stop screw.

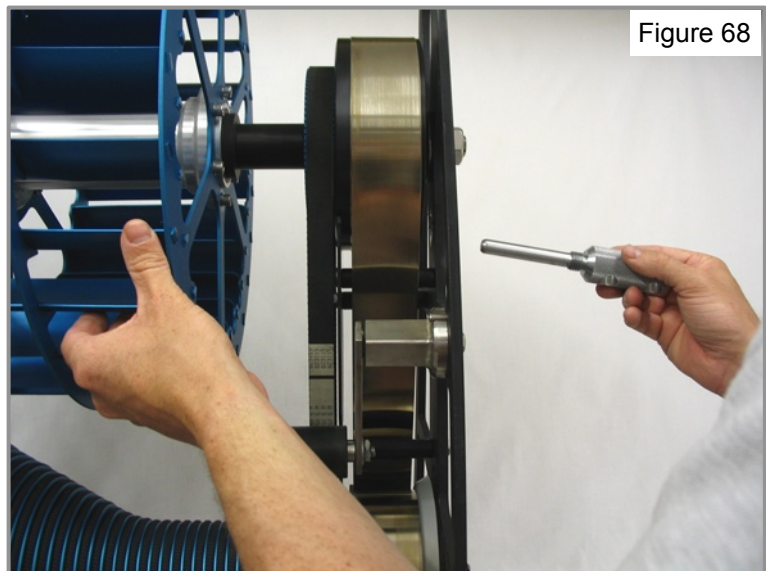

**Step 9**

Record the fact that the spring has been changed.

End of instructions for fitting a new rewind spring.