

LOCKED CLIPS

Instructions Manual

CE 0408 EN17109:2020/D

LockD Clips Communicating Safety System

Subject to Technical Changes

Table of Contents

List of figures	4
1. Use of the LockD Clips system	5
1.1. Intended use	5
1.2. In Horizontal Elements with Life Safety Lines	5
1.3. In Combination with Trolleys in Zip Lines	6
1.4. In Vertical Ascents/Descents with Fall Arrest Devices	7
2. Equipment Names & Designations	8
2.1. Carabiner Head	8
2.2. LockD Clips System	10
2.3. Communication control Banana	11
2.4. Identification	12
2.4.1. Identification label	12
2.4.2. Markings on the Carabiner Body	13
3. Accessories	13
3.1. Tweezle Variants	13
3.1.1. Standard Tweezle	13
3.1.2. Tweezle O	14
3.1.3. Rescue Tweezle	14
3.2. Exchangeable Modules	15
3.2.1. Stainless Steel Abrasion Guard	15
4. Connection between LockD Clips and Safety Harness	15
4.1. Connection to Lockd Clips with stiched swivel	15
4.1.1. Connection with Miallon Rapide	15
4.1.2. Connection with textile lanyard sling	16
4.2. Connection to Lockd Clips without stiched swivel	16
4.2.1. Connection with Maillon Rapide	16
4.2.2. Connection with textile lanyard sling	17
5. Before Using LockD Clips	17
5.1. Visual inspection of LockD Clips	17
5.2. Functional test	18
5.3. Control of the system	18
6. Operation of the LockD Clips system	18
6.1. Initial and Regular Preparations	18
6.2. Using LockD Clips as Personal Safety System	18
6.3. Open a LockD Clips Carabiner Head	19
6.4. Locking the Carabiner Heads by means of a Tweezle	19
7. Misuse and bugs	20
7.1. Excessive Twisting of the LockD Clips Lanyard Arms During Use	20



- 7.2. Carabiner Gate Cannot be Opened 21
- 7.3. Carabiner Gate Moves but does not Self-Close 21
- 7.4. Replacing the Spring 21
 - 7.4.1. Components of the Gate Spring 21
 - 7.4.2. Preparing to Install the Gate Spring 22
 - 7.4.3. Mounting the Gate Spring 22
- 7.5. Checking and Replacing the Abrasion Guard 23
 - 7.5.1. Examining the Abrasion Guard 23
 - 7.5.2. Removal and Replacement of an Abrasion Guard 24
- 7.6. Alpha Error: Both Carabiners can be Opened at the Same Time 25
- 7.7. Beta Error: Neither Carabiner Gate can be Opened 25
- 7.8. Replacing a User’s LockD Clips on a Ropes Course Due to Beta Error 26
- 8. Cleaning and Storage 28**
 - 8.1. Storing LockD Clips After Use 28
 - 8.2. Cleaning 28
 - 8.2.1. Cleaning of Textile Parts 28
 - 8.2.2. Removing Foreign Matters 28
 - 8.2.3. Cleaning with Moisture 29
 - 8.2.4. Lubrication and Oiling 29
 - 8.3. Storage 29
 - 8.4. Use after prolonged storage 30
- 9. Repair 31**
- 10. Other safety regulations 32**
- 11. Supplemental Issues 33**
 - 11.1. Conforming Standards 33
 - 11.2. Sales and Translations 33
 - 11.3. Regular Checks 33
 - 11.4. Life of Product 33
- 12. Annual Monitoring by Qualified Individuals 34**
 - 12.1. Inspection Criteria 34
 - 12.2. Inspection Procedures 34
 - 12.3. Inspection Report Templet 34
- 13. Your partner and direct contact for all kinds of questions 36**

List of figures

Figure 1: LockD Clips for securing horizontal elements in the rope course.....	6
Figure 2: LockD Clips when using zip lines	6
Figure 3: LockD Clips to secure vertical ascents and descents	7
Figure 4: Carabiner Head	8
Figure 5: Total system.....	10
Figure 6: Communication control Banana	11
Figure 7: Identification label and serial number	12
Figure 8: Tweezle	13
Figure 9: Tweezle O	14
Figure 10: Rescue Tweezle.....	14
Figure 11: Stainless steel abrasion guard.....	15
Figure 12: Connection with harness using Maillon Rapide in stiched in swivel.....	16
Figure 13: Connection with harness using swivel and textile sling (girth hitch)	16
Figure 14: Connection to harness with Maillon Rapide	17
Figure 15: Connection to harness with maillon rapide and lanyard.....	17
Figure 16: Opening the unlocked hook by pressing on the carabiner gate, the second carabiner remains locked	19
Figure 17: Tweezeling an unlocked carabiner head.....	20
Figure 18: Life Safety Ropes of a Ropes Course with Tweezles Installed.....	20
Figure 19: Components of the gate spring	21
Figure 20: Positioning of the two springs one behind the other	22
Figure 21: Fastening and gluing the screw.....	22
Figure 22:: Slightly worn abrasion guard - does not require replacement	23
Figure 23: Worn abrasion guard - needs replacement	23
Figure 24: Mount the carabiner hook on the disassembly adapter.....	24
Figure 25: Alpha error.....	25
Figure 26: Beta error.....	26
Figure 27: User with both carabiners locked (Beta error)	26
Figure 28: Replacement LockD Clips system to be installed with non-functioning system still connected.....	27
Figure 29: Non-functioning unit is detached from the user after the new unit is attached to the user and life safety line	27
Figure 30: Use of the Carabiner Removing Tool with safety gloves	28
Figure 31: Storage after use.....	30

1. Use of the LockD Clips system

1.1. Intended use

The LockD Clips safety system is used with a connecting lanyard in accordance with EN 362 (Kat Q), a safety harness in accordance with EN 361, or a climbing harness in accordance with EN 12277, exclusively to protect individuals instructed in their use, against falls that can cause injury on a ropes course.

It is always used in conjunction with suitable attachment connection: a horizontal or slightly inclined textile sling or lanyard, or an appropriately rated metal connector. This textile or metal connector must be chosen by a qualified professional, rated for life safety and meet all jurisdictional standards.



Danger of severe injury or death can be caused if the attachment connection does not meet life safety standards.

Life safety components of a ropes course such as wire rope, attachment rings, or textile ropes must be equipped with a "Tweezle", a mechanical identification point.

The Tweezle is a type of "key" that enables the carabiners on LockD Clips to lock and unlock in order to perform their safety function and enable a user to move through the elements of a ropescourse without being able to disconnect from the life safety line.



Unauthorized use of LockD Clips can lead to severe injury or death. It is the builder's/operator's responsibility to properly and appropriately provide LockD Clips to their participants at their own risk.

LockD Clips are intended to be used in the for the following manner:

1.2. In Horizontal Elements with Life Safety Lines

Horizontal elements or elements with only a slight incline in a rope course must use a Tweezle at the entry point. The user can use the unlocked carabiner of the LockD Clips to tweezle in order to hook onto the life safety line and allowing the second carabiner to unlock and detach from the previous life safety line, and continue progressing through the ropes course.

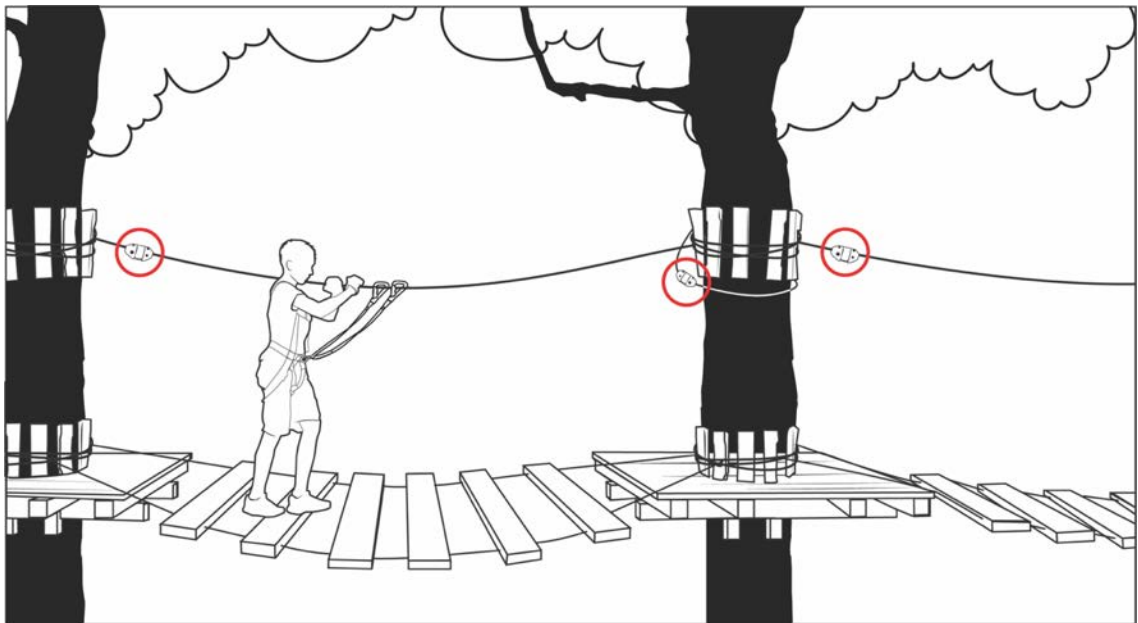

Figure 1: LockD Clips for securing horizontal elements in the rope course



LockD Clips may only be used on life safety lines that have been designed by a qualified professional and inspected according to jurisdictional standards.

1.3. In Combination with Trolleys in Zip Lines

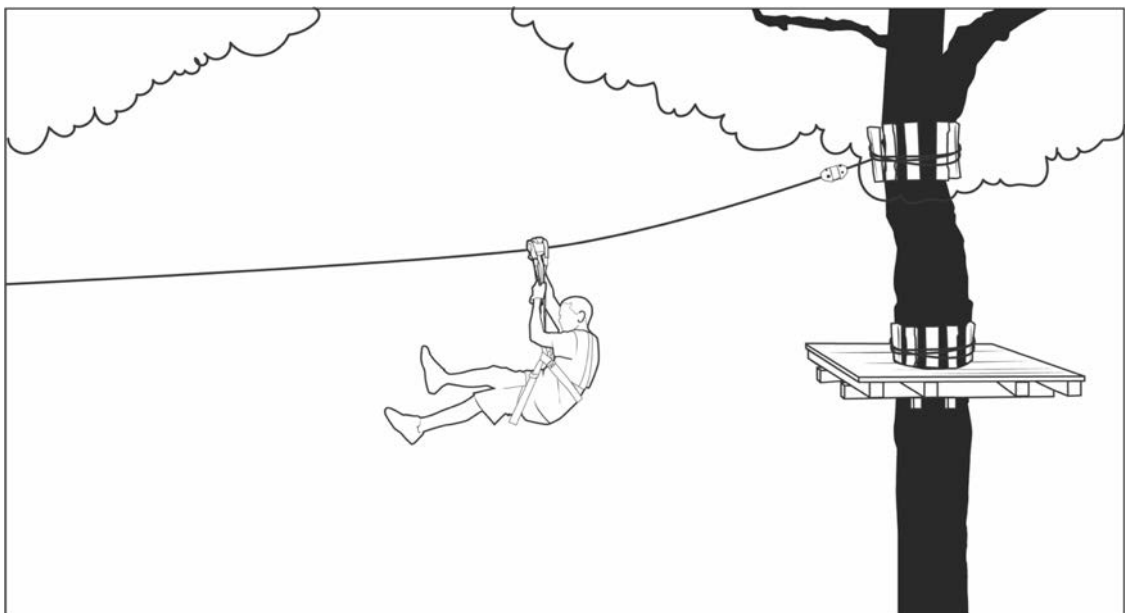

Figure 2: LockD Clips when using zip lines

As 1.2 with an additional pulley.

1.4. In Vertical Ascents/Descents with Fall Arrest Devices

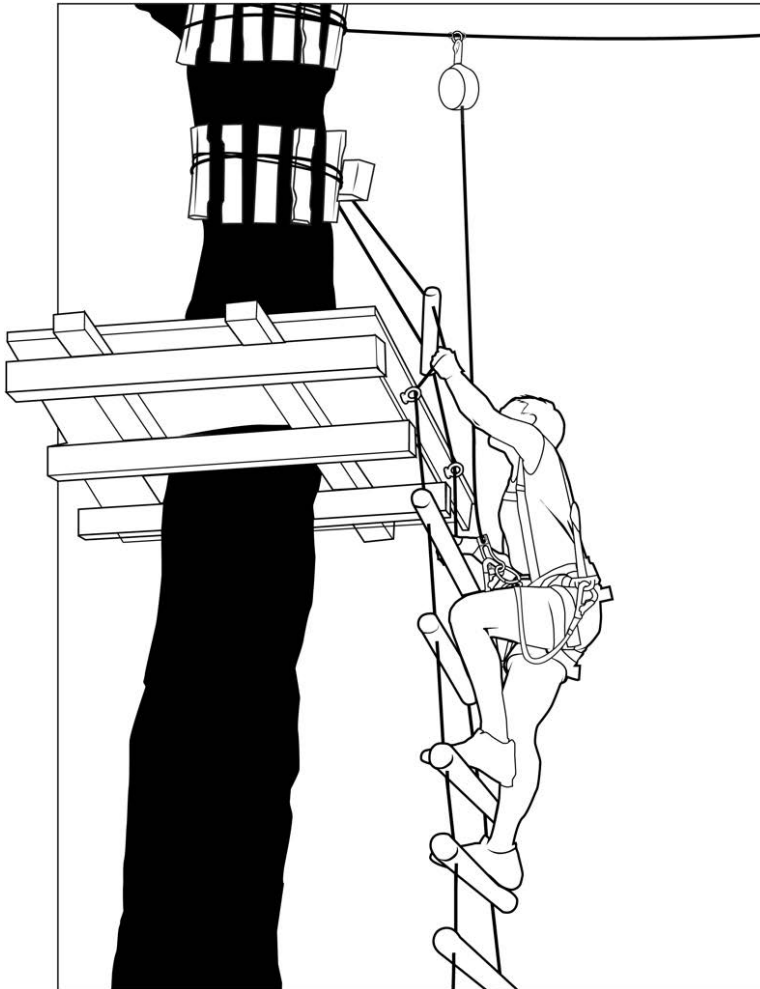

Figure 3: LockD Clips to secure vertical ascents and descents

A fall arrest device requires a Tweezle O or equivalent as an attachment point for the LockD Clips carabiner. The user tweezles themselves onto the attached Tweezle O with the unlocked carabiner of the LockD Clips, allowing the other carabiner to be unlocked and able to detach from their previous life safety line, then ascend or descend using the fall arrest device.



LockD Clips may only be used on life safety lines that have been designed by a qualified professional and inspected according to jurisdictional standards.

2. Equipment Names & Designations

2.1. Carabiner Head

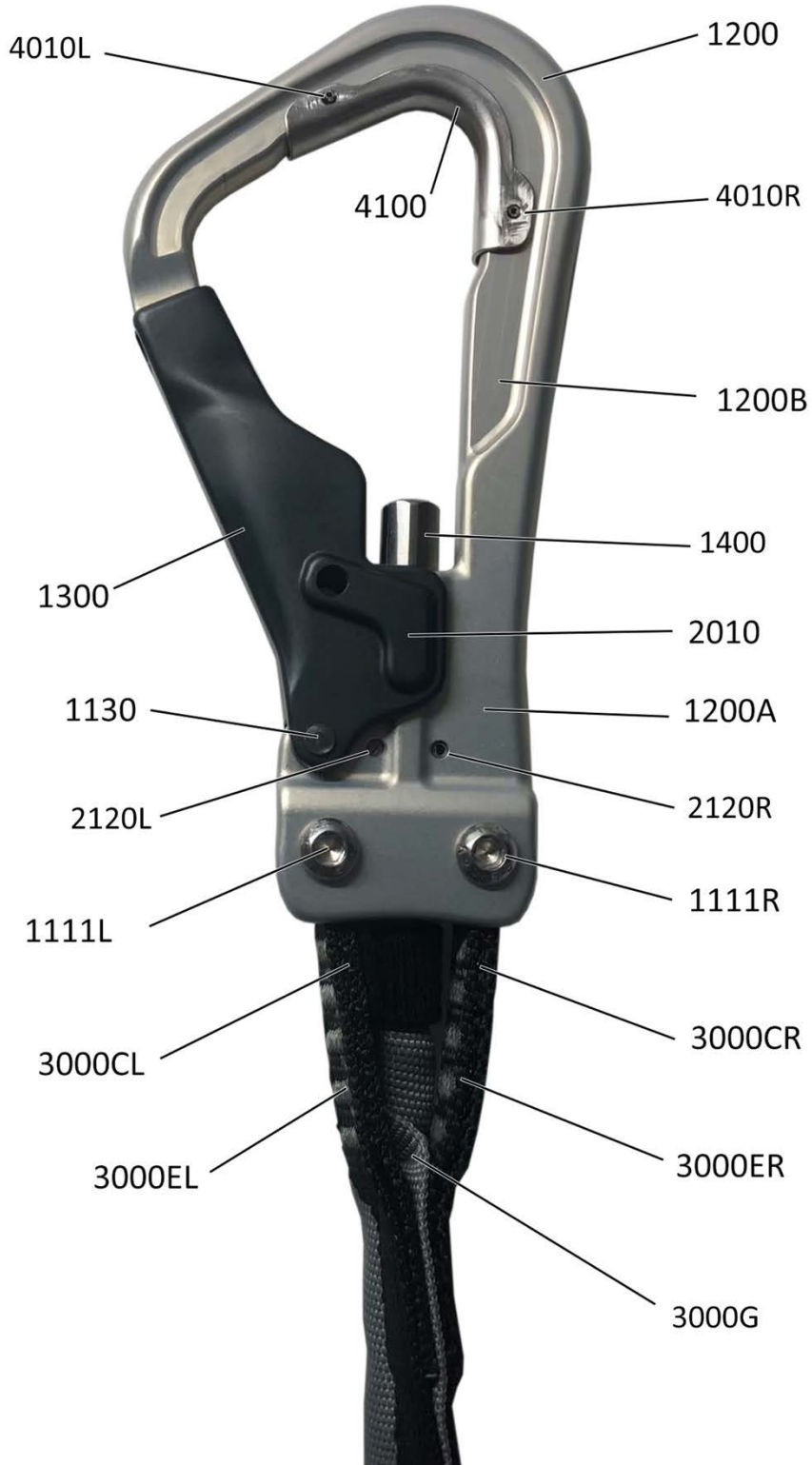

Figure 4: Carabiner Head

No.	Label
1200	Carabiner body, forged from high-strength aluminum alloy
1200A	Abbreviated logo
1200B	Batch Number Date of manufacture, where the first two digits represent the year, the third and fourth digits represent the week of production
1111L	Left-hand securing bolts for textile connectors
1111R	Right-hand securing bolts for textile connectors
2121L	Left attachment of the plug-in unit
2121R	Right attachment of the plug-in unit
1130	Connection pin for carabiner gate
4010L	Left locking pin for abrasion guard or other module attachment.
4010R	Right locking pin for abrasion guard or other module attachment.
1300	Carabiner gate, forged from high-strength aluminum alloy
2010	Locking pin of the communication system (not visible)
1400	Threaded top
3000	Textile with communication system
3000CL	Left textile tab for fastening to screwing
3000CR	Right textile tab for fastening to screwing
3000EL	Sewing of the left textile tab for fastening to the screw
3000ER	Sewing of the left textile tab for fastening to the screw
4100	Abrasion guard (and attachment location of other modules)

2.2. LockD Clips System

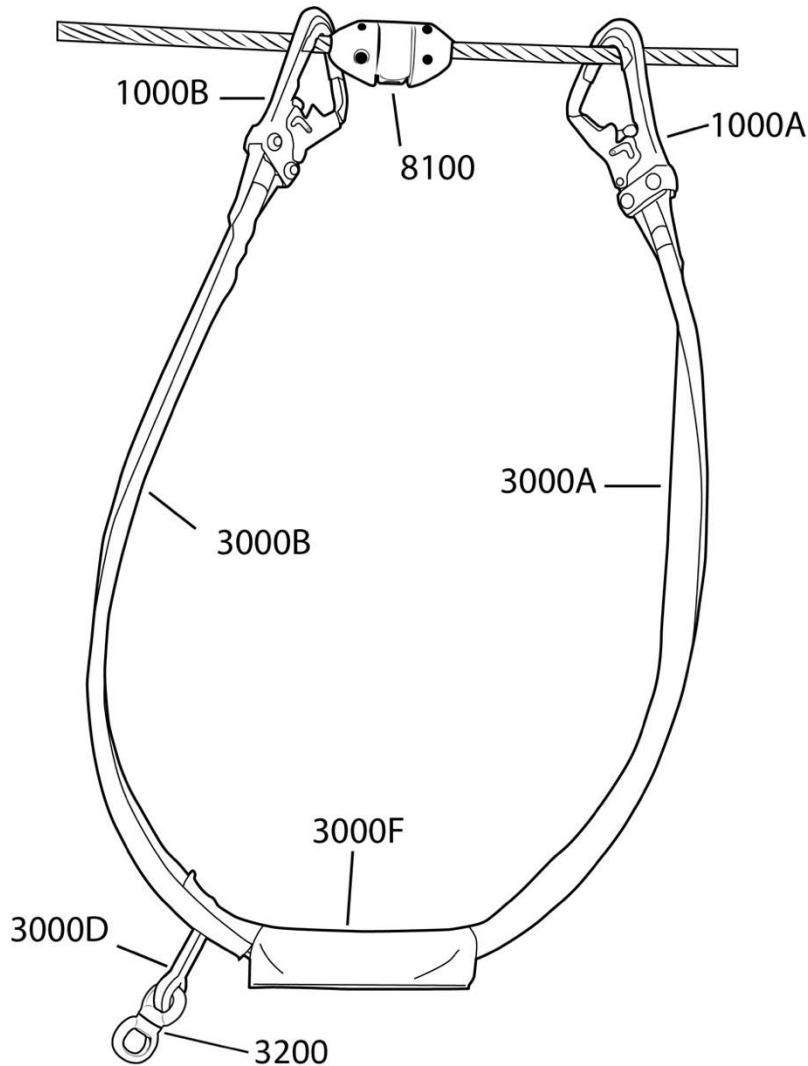

Figure 5: Total system

No.	Label
1000A	Carabiner hook on the long arm
1000B	Carabiner hook on short arm
3000A	A Textile lanyard with communication system (cowtail), long arm
3000B	Textile lanyard with communication system (cowtail), short arm
3000D	Stitched loop for connection to the user's safety harness with Maillon or swivel
3000F	Protective cover for "Banana" (locking and adjustment mechanism of the communication system)
3200	Swivel (stainless steel)
8100	Tweezle

2.3. Communication control Banana

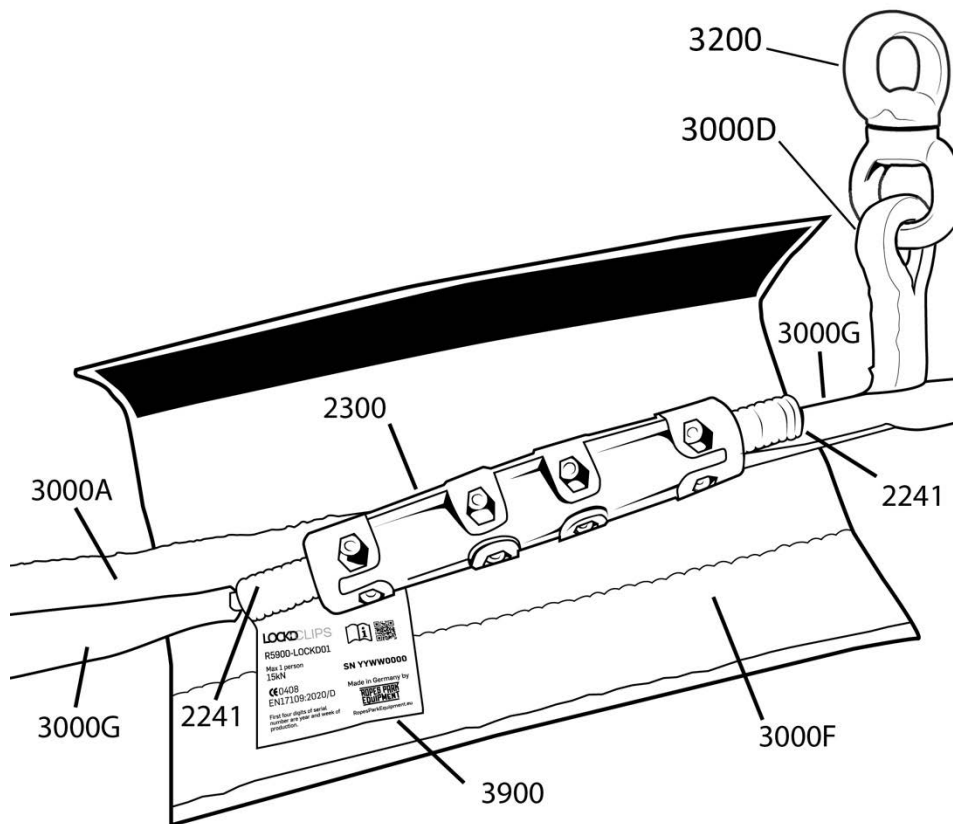

Figure 6: Communication control Banana

Nr.	Label
2241	Bowden cover in long arm
2242	Bowden cover in short arm
2300	Banana, consisting of 2 identical, screwed-together plastic parts
3000A	Textile connection long arm
3000B	Textile connection short arm
3000D	Hanging loop for connection with climbing harness
3000F	Protective cover for banana with Velcro
3000G	Textile guide for the Bowden cable
3200	Swivel (stainless steel)
3900	Identification label (details below)

In the center of the banana there are two neodymium ring magnets.



The center of the banana is magnetic, keep pacemakers at least 8cm away.

2.4. Identification

2.4.1. Identification label

A label with all the relevant information about each LockD Clips unit can be found in the Banana's protective wrap. Open the Velcro fastener to view.

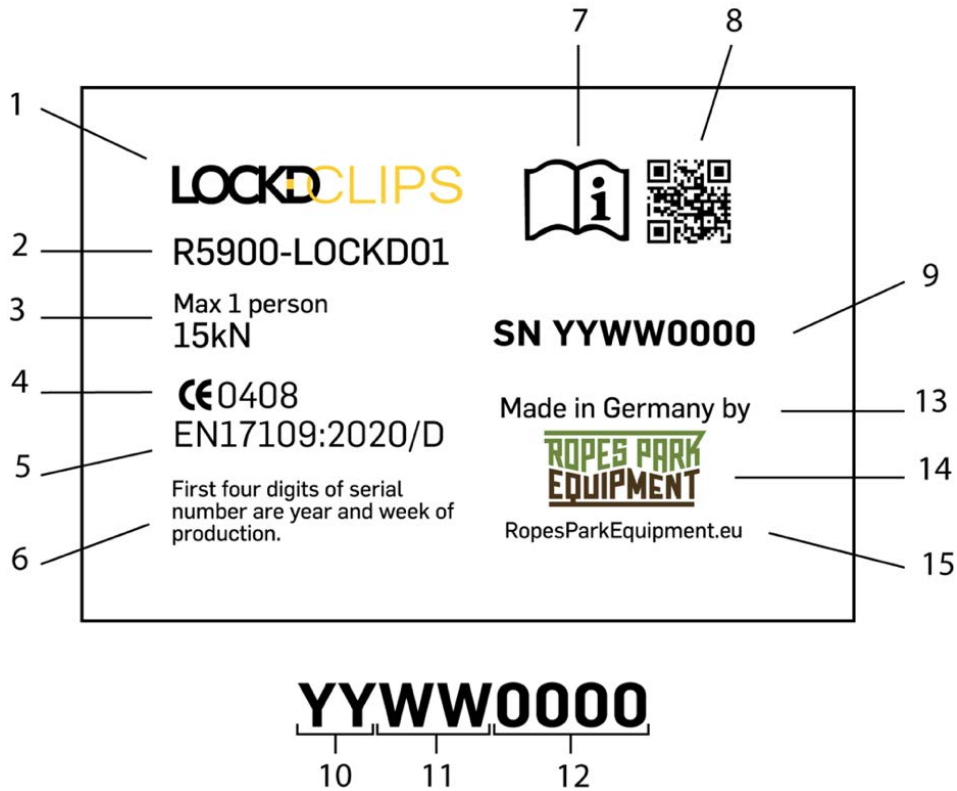

Figure 7: Identification label and serial number

No.	Label
1	Product name and logo
2	Model designation
3	Maximum number of people for simultaneous use and minimum braking load
4	Certifying body
5	Relevant standard
6	System of serial number
7	Reference to Operations Manual
8	QR Code - this is to the manufacturer's website
9	Serial number
10	Year of production of the batch
11	Week in the year of production of the batch
12	Continuous number of the batch
13	Country of Origin
14	Name and logo of the manufacturer
15	Website of the manufacturer

2.4.2. Markings on the Carabiner Body

The short product name "LockD" and the batch number are shown on the carabiner body. The batch number corresponds to the first 4 digits of the serial number (as shown on the identification label).

3. Accessories

3.1. Tweezle Variants

3.1.1. Standard Tweezle

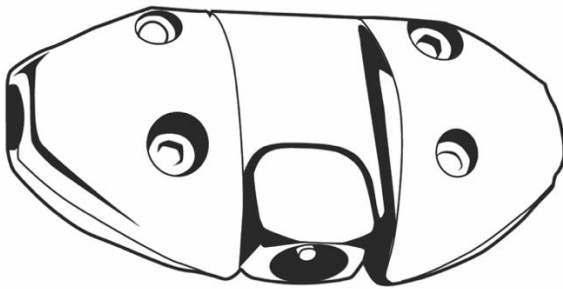

Figure 8: Tweezle

Tweezle is a type of "key" that installs on horizontal life safety lines of 9 to 13mm diameter. The Tweezle consists of 2 plastic halves, they are attached to the life safety line by screwing the two halves together.

LockD Clips can be used and function as designed once a Tweezle has been mounted on a life safety line.

Tweezle are available in several different colors.

Please mind the operating manual of the Tweezle.



A Tweezle must only be installed on suitably rated and approved life safety line.



Please note that this product has its own instruction manual.

3.1.2. Tweezle O

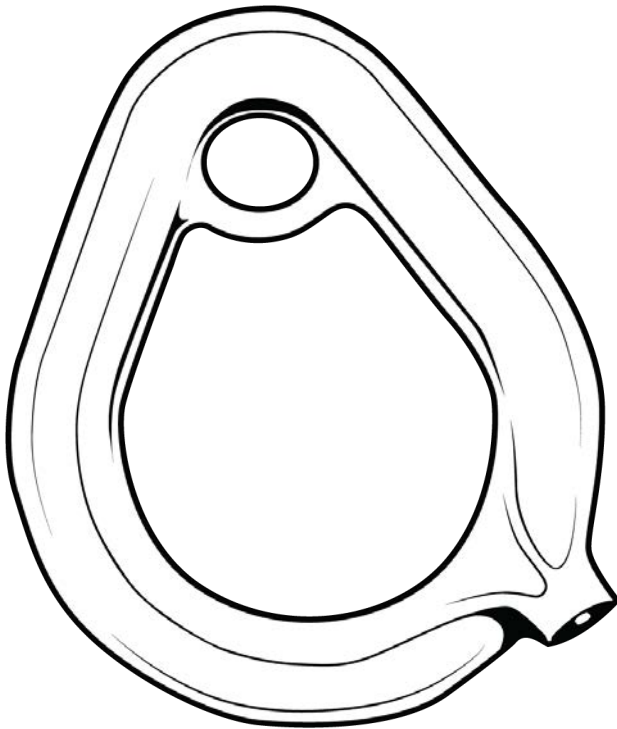

Figure 9: Tweezle O

The Tweezle O replaces a standard Tweezle to permanently attach to a mechanical or non-mechanical device by means of a life saving rated screw link. The attachment point must be approved for life safety in a ropes course.

Please mind the operating manual of the Tweezle O.

3.1.3. Rescue Tweezle

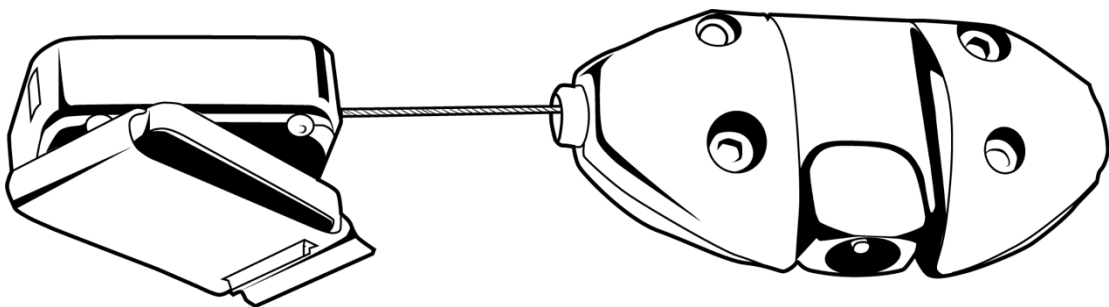

Figure 10: Rescue Tweezle

The Rescue Tweezle is used by trained park staff for assisting users when a user requires their LockD Clips to be disconnected from the life safety line, for example when performing rescues, or conducting evacuations. The Rescue Tweezle allows staff to remove a user of LockD Clips from a life safety line any time needed. The Rescue Tweezle must only be used by qualified personnel having had appropriate training. If used incorrectly, the LockD Clips user may have both clips unlocked when at height!

Keep all Tweezles away from unqualified, untrained individuals.



A Rescue Tweezle and any Tweezle not permanently mounted on a life safety line can allow a LockD Clips user to be unsecured on a ropes course.

3.2. Exchangeable Modules¹

Different modules can be mounted on the carabiner head of the LockD Clips for different intended uses. The modules can also be different on each head, for example an abrasion guard can be mounted on one head and a roller can be mounted on the other head.

3.2.1. Stainless Steel Abrasion Guard



Figure 11: Stainless steel abrasion guard

The stainless-steel abrasion guard (1.5mm thickness) protects the aluminum carabiner body from wear and damage. The plate can be changed using commonly available tools following specific instructions, see section 7.3.

4. Connection between LockD Clips and Safety Harness

The LockD Clips system is to be used with an EN 361 approved safety harness or an EN 12277 approved climbing harness. The connection between LockD Clips and the climbing harness can be done by several means.

4.1. Connection to Lockd Clips with integrated swivel

4.1.1. Connection with Miallon Rapide

The LockD Clips with stiched swivel can be connected to the harness with an EN 362 (Kat Q) connector (typically Maillon Rapide). Make sure, that the connector can not be opened by the climber.

¹ When available

4.1.2. Connection with textile lanyard sling

If necessary, the connection between the harness and LockD Clips can be extended with a rated textile sling. To minimize risk of strangulation, open slings longer than 50 cm must not be used as a connection material but be longitudinally sewn to form a single lanyard.



Use only approved and rated connection devices (CE stamped) that meet the required minimum breaking load.

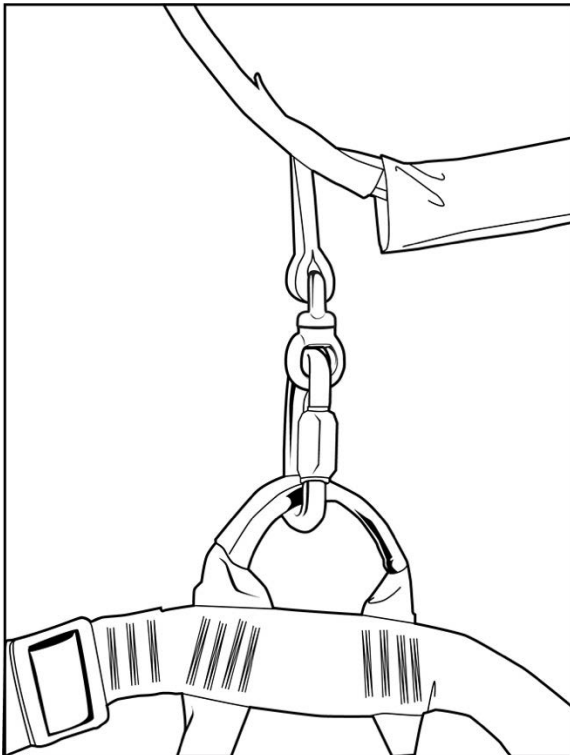

Figure 12: Connection with harness using Maillon Rapide in integrated swivel

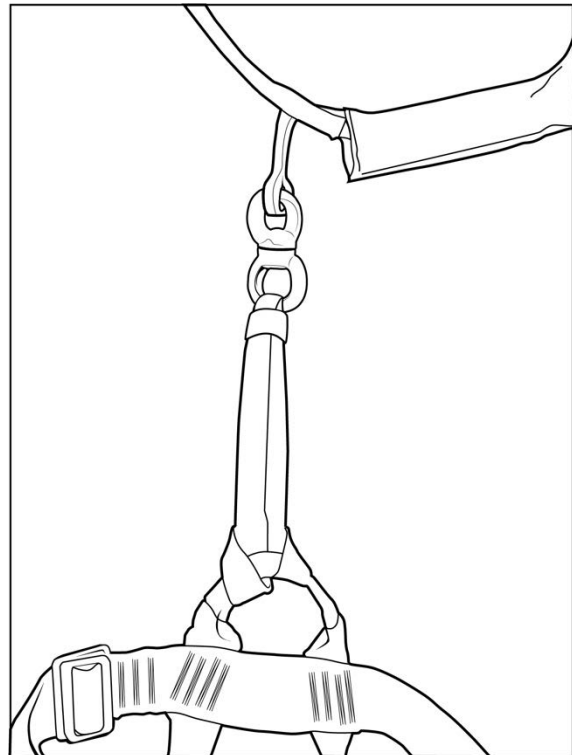

Figure 13: Connection with harness using swivel and textile sling (girth hitch)

4.2. Connection to Lockd Clips without integrated swivel

4.2.1. Connection with Maillon Rapide

The LockD Clips can be connected to the harness with an EN 362 (Kat Q) connector (typically Maillon Rapide). Make sure, that the connector can not be opened by the climber.

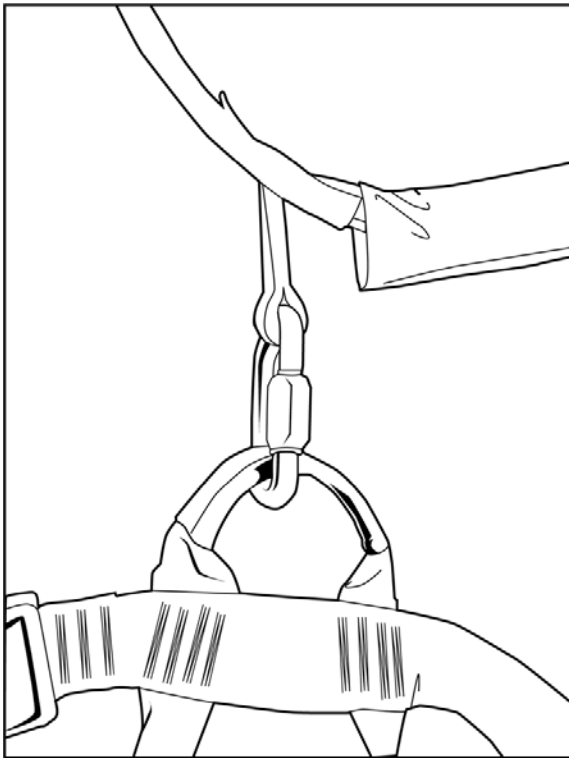

Figure 14: Connection to harness with Maillon Rapide

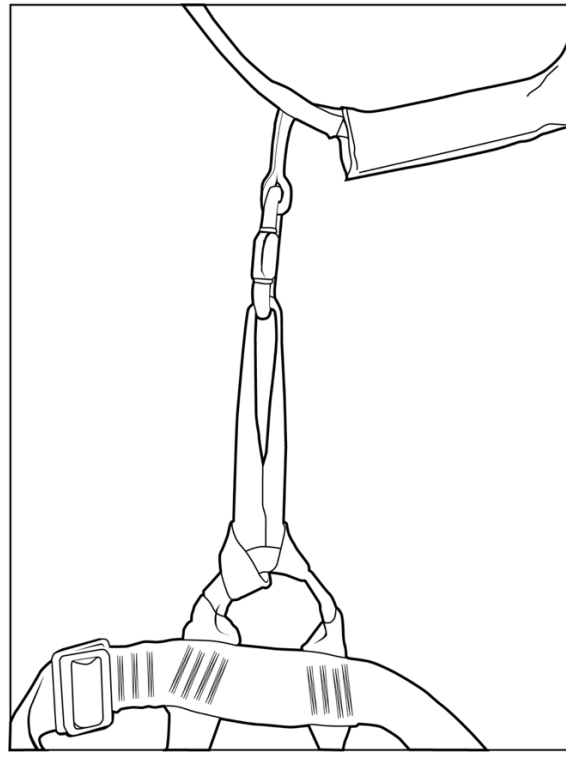

Figure 15: Connection to harness with maillon rapide and lanyard

4.2.2. Connection with textile lanyard sling

If necessary, the connection between the harness and LockD Clips can be extended with a rated textile sling. To minimize risk of strangulation, open slings longer than 50 cm must not be used as a connection material but be longitudinally sewn to form a single lanyard.

5. Before Using LockD Clips



Carry out visual and functional tests before each use.

LockD Clips may not be used if any malfunctioning, deterioration, wear, defect or vandalism is observed.

Defects must be brought to the attention of the manufacturer immediately to be examined and repaired by the manufacturer or an authorized representative.

5.1. Visual inspection of LockD Clips

- Check that all parts are present and assess their condition: Carabiner heads, Bowden, locking housing units, cowtails, etc.
- Check metal parts for possible deformation, cracks, corrosion, wear.
- Check the wear of the abrasion guard.

- Check that all screws, nuts and bolts, etc. are in place and tight, gate and gate springs are functioning properly.
- Textile parts are free from cuts, abrasion, fraying, or any other damage, and sewn seams and connection & sewn points are intact.
- LockD Clips are securely attached to the harness or safety belt.

5.2. Functional test

- Check to make sure LockD Clips locking mechanism functions properly allowing only one carabiner gate to open at a time.
- Carabiner gate self-closes when let go after opening.
- Insert unlocked carabiner head onto a Tweezle to observe it locking. Repeat with other side to determine proper locking and unlocking of each.
- Make sure both carabiner heads are not unlocked at the same time

5.3. Control of the system

- Check to make sure LockD Clips locking mechanism functions properly allowing only one carabiner gate to open at a time.
- Determine that LockD Clips are securely attached to the harness or safety belt.
- Place the unlocked carabiner head on a life safety line, then,
- Tweezle to make sure the carabiner locks and the other carabiner head unlocks.

6. Operation of the LockD Clips system

6.1. Initial and Regular Preparations

- Read the instruction manual.
- If possible, obtain firsthand instruction by a manufacturer or a manufacturer's representative.
- Ask the manufacturer or manufacturer's representative to allow you to personally practice using LockD Clips as an end user would.
- Familiarize users by providing an oral and visual briefing, then allow them to personally perform the task of tweezling to lock and unlock the LockD Clips.
- Test before each use that the locking/unlocking mechanism functions properly.
- Do not allow LockD Clips to be used if you find have misgivings, have any questions, or believe the units are malfunctioning.

6.2. Using LockD Clips as Personal Safety System

The initial tweezling of a LockD Clips carabiner is of critical importance, thus a Tweezle Barrier with signage should be installed to facilitate and encourage the user to tweezle prior to entering the first ropes course element. Once the user tweezles onto the Tweezle Barrier, the user has engaged the LockD Clips system and is secured by its locking/unlocking functionality throughout the course, until the user is provided an "exit" Tweezle.



Ensure a Tweezle Barrier with signage is installed to facilitate and encourage the user to tweeze prior to entering the first ropes course element.

6.3. Open a LockD Clips Carabiner Head

Note that only one carabiner of the LockD Clips system can be opened at a time.

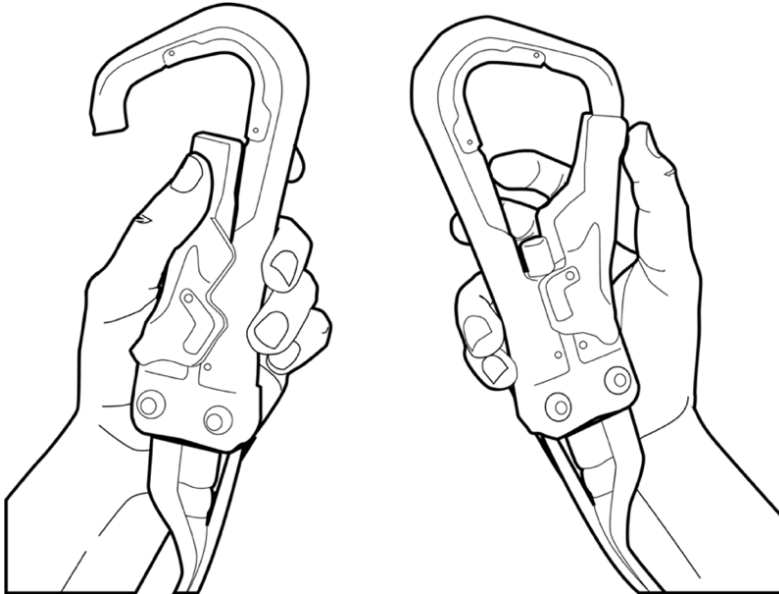

Figure 16: Opening the unlocked hook by pressing on the carabiner gate, the second carabiner remains locked

You can check which carabiner gate can be opened by:

- Pressing the gate of one of the two carabiner heads to determine whether it can press to be opened, if unable to be opened, then
- Press the gate of the other carabiner head to open and remove from the corresponding life safety line or specialty Tweezle.
- The unlocked carabiner head can then be tweezeled on a corresponding life safety line or specialty Tweezle.

6.4. Locking the Carabiner Heads by means of a Tweezle

- Place the open carabiner head on the life safety line adjacent to an installed Tweezle and allow the gate to close,
- Align the locking housing unit at the base of the carabiner head with the center of the installed Tweezle,
- Push the locking housing unit of the unlocked carabiner head forcefully up into the center pin of the Tweezle to:
 - Activate the internal cable situated within the Bowden shield,
 - The locked carabiner head will remain on the current life safety line until
 - the connected unlocked carabiner head is tweezeled and locked on another life safety rope.

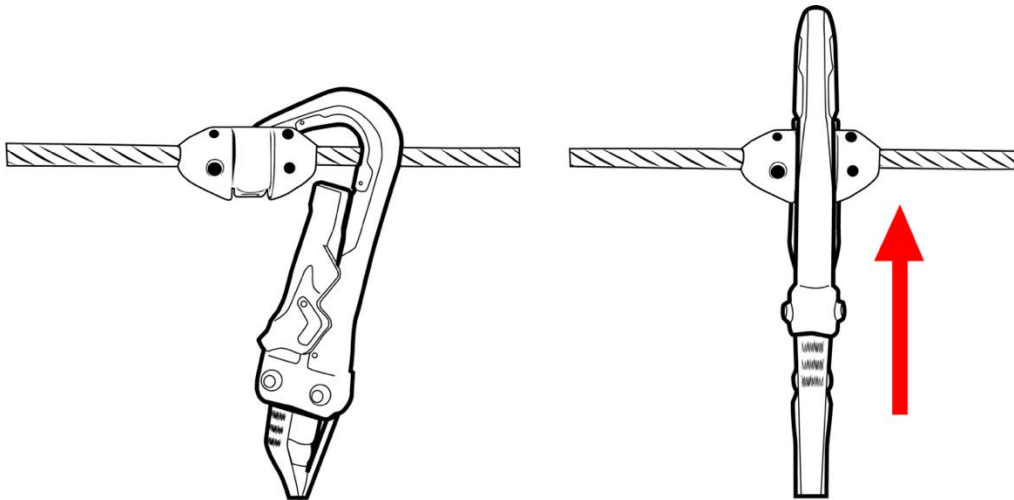

Figure 17: Tweezeling an unlocked carabiner head

The use of the LockD Clips system requires the installation of Tweezles at all designated life safety clipping points, allowing the user to advance from one element to the next.

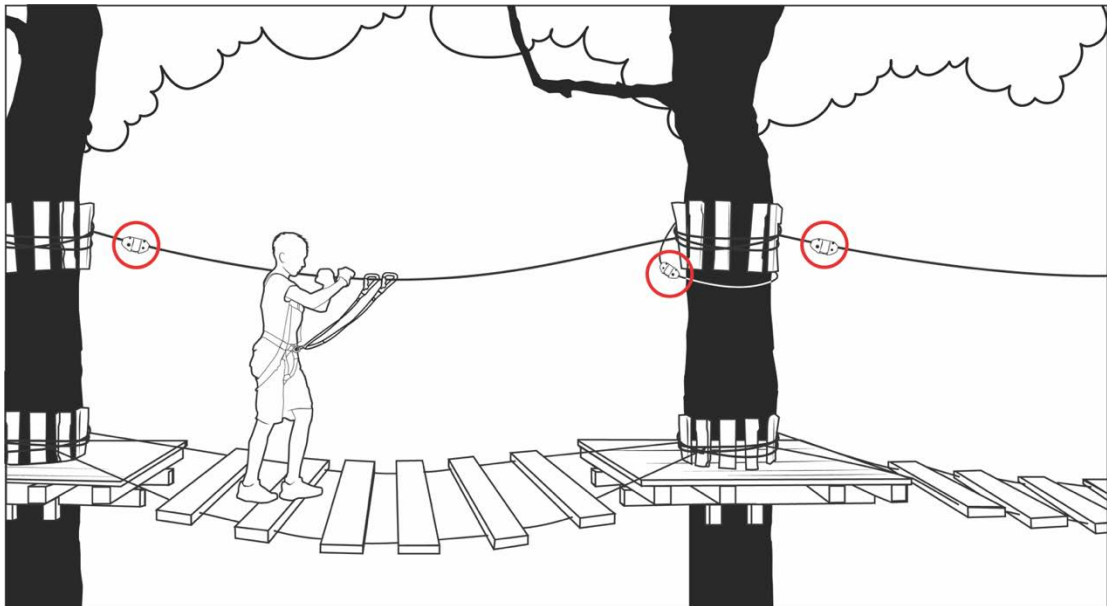

Figure 18: Life Safety Ropes of a Ropes Course with Tweezles Installed

7. Misuse and Troubleshooting

7.1. Excessive Twisting of the LockD Clips Lanyard Arms During Use

If inexperienced users tweeze without thought, lanyard arms can twist several times until free travel of the Bowden cable is blocked, making subsequent tweezing difficult or impossible.



Instruct users to straighten the lanyard arms by regularly un-twisting them after tweezing.

7.2. Carabiner Gate Cannot be Opened

If a carabiner gate cannot be pressed to open, first check to see if the other connected carabiner gate can open, indicating poor tweezing of the unlocked carabiner. Therefore, tweeze more forcefully to lock one head and unlock the other.

If both carabiner gates are locked, even after forcefully tweezing one of the carabiners again, a beta error has occurred, see section 8.6.

Checks to perform:

- Is the gate being restricted by a foreign object such as a pebble or a stick?
 - Is the locking mechanism being restricted by a foreign object such as sand, dust or debris?
 - Is the gate rivet point being restricted by any type of debris or corrosion?
- If after performing checks above both gates remain locked, contact the manufacturer or a manufacturer representative for servicing.

7.3. Carabiner Gate Moves but does not Self-Close

If a carabiner gate moves back and forth but does not self-close, it may indicate that the gate spring needs to be replaced.

As a wear part, the gate spring can be replaced with factory parts on-site.

7.4. Replacing the Spring

7.4.1. Components of the Gate Spring

The spring consists of the following components:

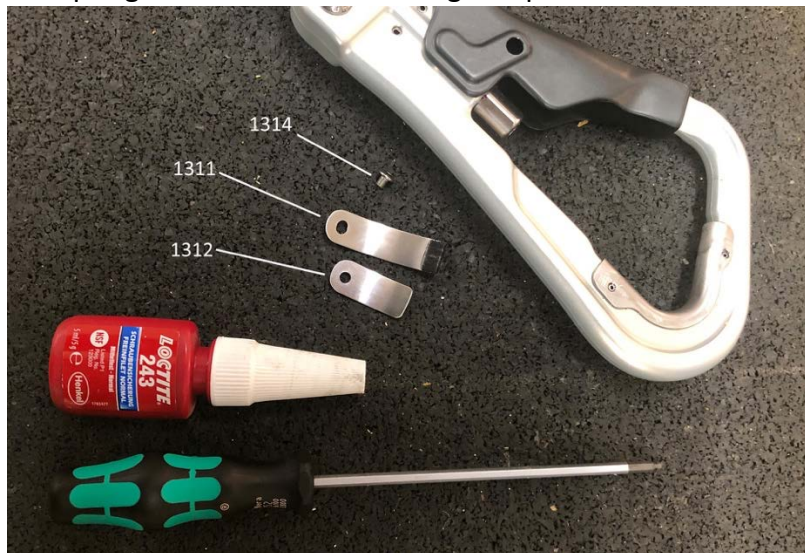

Figure 19: Components of the gate spring

No.	Label
1311	Outer spring of the gate with slider
1312	Inner spring of the gate
1314	Spring screw of the gate

The three components of the gate spring are delivered as a set.

7.4.2. Preparing to Install the Gate Spring

Tools required:

- A 2mm allen screwdriver
- Medium-resistant screw adhesive such as Loctite 243 or equivalent
- Make sure you have a clean and clear workspace.

7.4.3. Mounting the Gate Spring

First insert the smaller outer spring with the belly down, then the larger inner spring with the belly down and align holes on both using the allen screwdriver.

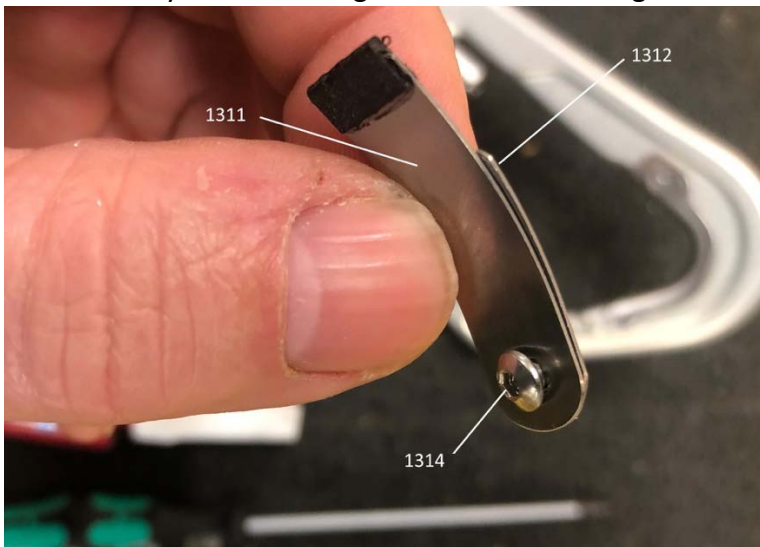

Figure 20: Positioning of the two springs one behind the other

Now position the springs with the help of the allen screwdriver in the recess inside the gate and align the holes with the screw hole.



Figure 21: Fastening and gluing the screw

Always use the new screw supplied by the manufacturer.

Place a drop of medium-resistant screw glue (if not already present) on the thread of the screw and screw the screw in the counter thread until tight. Caution: Do not over-tighten or screw threads may strip. Do not use a mechanical screwdriver.

Check to make sure gate is moving freely and easily.

If necessary, lubricate the axis of the gate with dry lubricant. If the gate continues to bind after replacement of the spring and lubrication, contact the manufacturer or a manufacturer's representative.

7.5. Checking and Replacing the Abrasion Guard

7.5.1. Examining the Abrasion Guard

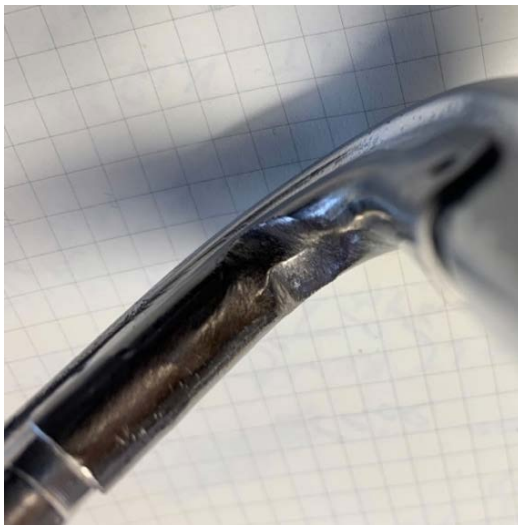

Figure 22:: Slightly worn abrasion guard - does not require replacement



Figure 23: Worn abrasion guard - needs replacement

The abrasion guard must be replaced before it is worn through and the body of the aluminum carabiner head behind it exposed

Do NOT use the LockD Clips if the aluminum carabiner body is worn more than 1mm, the LockD Clips must be sent to the manufacturer or manufacturer representative for replacement of the carabiner head.

Replacing an abrasion guard over a worn/damaged carabiner body is NOT permitted and can lead to serious injury or death.



Do not use a carabiner body if it is worn more than 1mm.



Do not install a new abrasion guard on a worn/damaged carabiner body.

7.5.2. Removal and Replacement of an Abrasion Guard

1. Mount the carabiner hook on the disassembly adapter

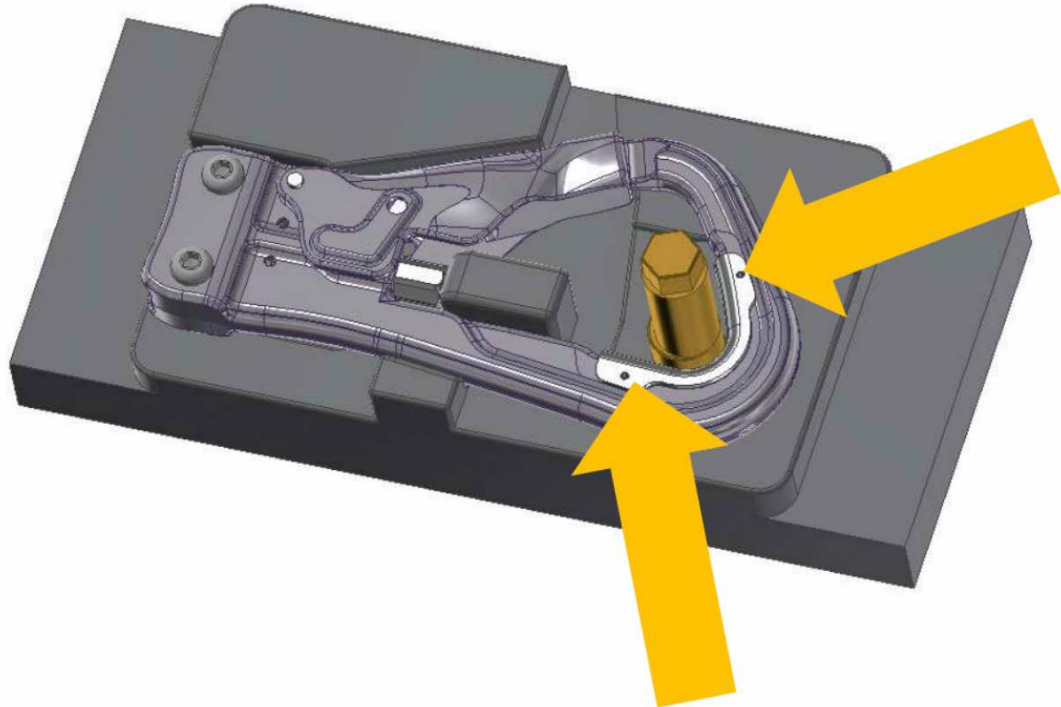

Figure 24: Mount the carabiner hook on the disassembly adapter

2. Use a 2mm pin-punch driver and a small hammer to remove the two clamping pins,
3. Remove the used abrasion guard by pulling off,
4. Check whether the used abrasion guard has been worn-through and created a hole in it from excessive wear. If so, this may indicate excessive wear of the aluminum carabiner body as well,
5. Check the carabiner body for wear more than 1mm,
6. If the carabiner body is intact and not worn, the new abrasion guard can be installed.
7. Position a new abrasion guard on the delineated location of the carabiner body until the pin holes are aligned,
8. If not using the disassembly adapter, position the carabiner body on a semi-hard surface (wood block, hard rubber or plastic), do not place on hard surfaces such as steel or stone,
9. Using a light hammer, carefully align and hammer in a new clamping pin into the holes on each side of the abrasion guard,
10. If necessary, use a 2mm pin punch to make the pins flush with all surfaces of the new abrasion guard.

7.6. Alpha Error: Both Carabiners can be Opened at the Same Time

When both carabiner gates can be opened at the same time, Alpha Error has occurred. LockD Clips carabiner heads are designed as traditional carabiners and thus the user is still protected as if they were using a traditional non-interconnected via ferrata set, but the LockD Clips system no longer prevents the user from disconnecting both carabiners from a life safety line at the same time.



If an Alpha Error occurs during regular testing, or during use by the user, the LockD Clips unit must be replaced with an error-free set immediately, marked "DO NOT USE", and sent for repair to the manufacturer or a manufacturer's representative.

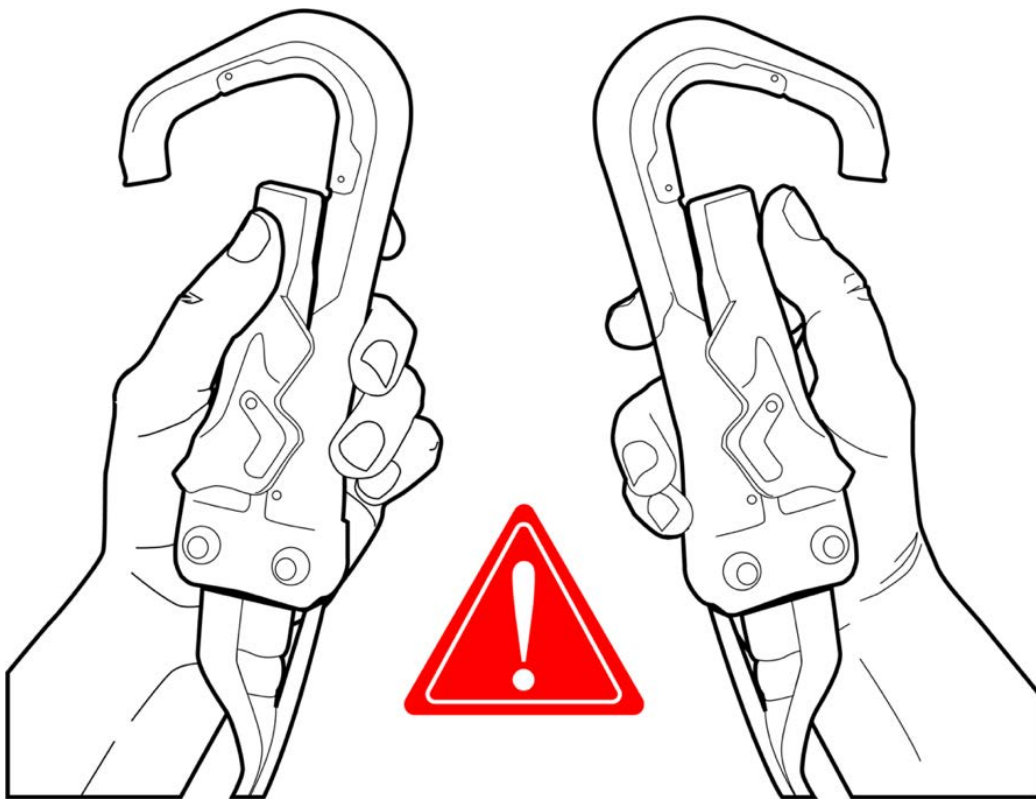

Figure 25: Alpha error

7.7. Beta Error: Neither Carabiner Gate can be Opened

When both carabiner gates of a LockD Clips unit remain locked at the same time, Beta Error has occurred. Although the user is secured on a life safety line, they are unable to progress through the ropes course.

Exam the system and verify the system has not been overly twisted, if so, untangle and test both gates again.

Occasional Beta Error occurrence is neither a safety risk or need for repair as uninformed users may overly twist the units unintentionally. If Beta Error occurs frequently on the same LockD Clips unit, tag/mark the unit accordingly and send to the manufacturer or a manufacturer's representative for repair.

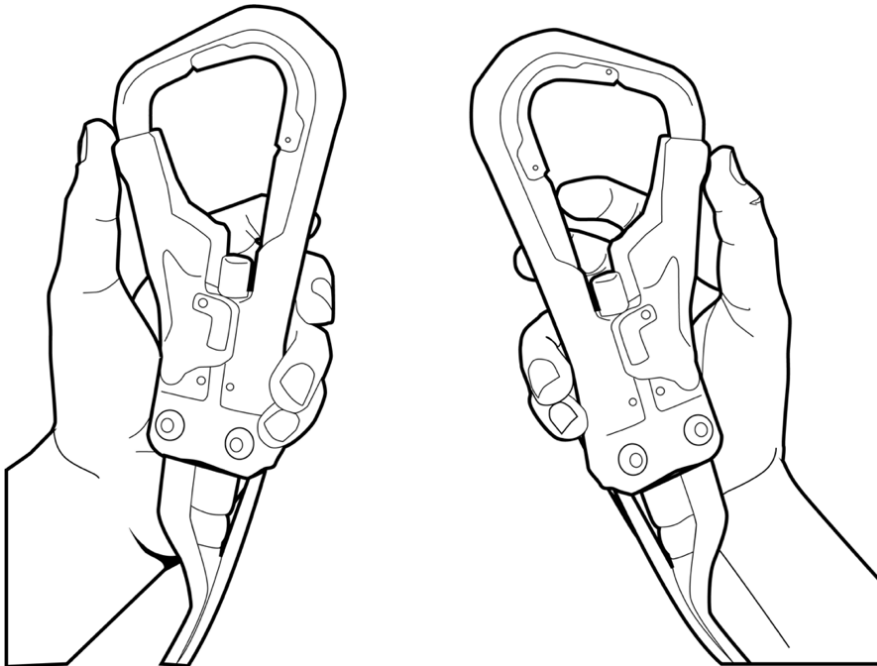

Figure 26: Beta error

7.8. Replacing a User's LockD Clips on a Ropes Course Due to Beta Error

If both carabiner gates cannot be opened while the user is attached to a life safety line, proceed as follows:

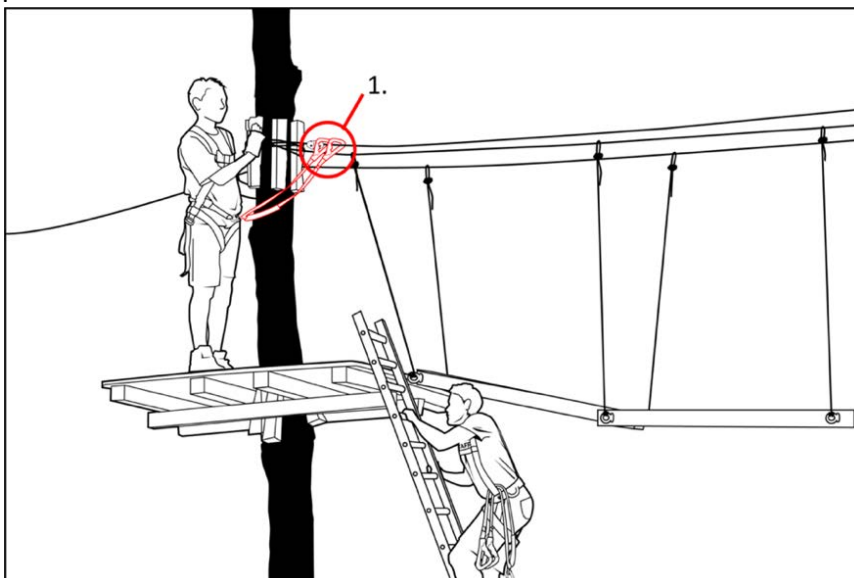

Figure 27: User with both carabiners locked (Beta error)

1. The user's safety is not compromised but both carabiner gates are locked, and user cannot continue on the course.
2. A trained staff member carrying a tested replacement LockD Clips unit is dispatched to the user, equipped with tools to both remove the unit from the life safety line and the user's harness connection.

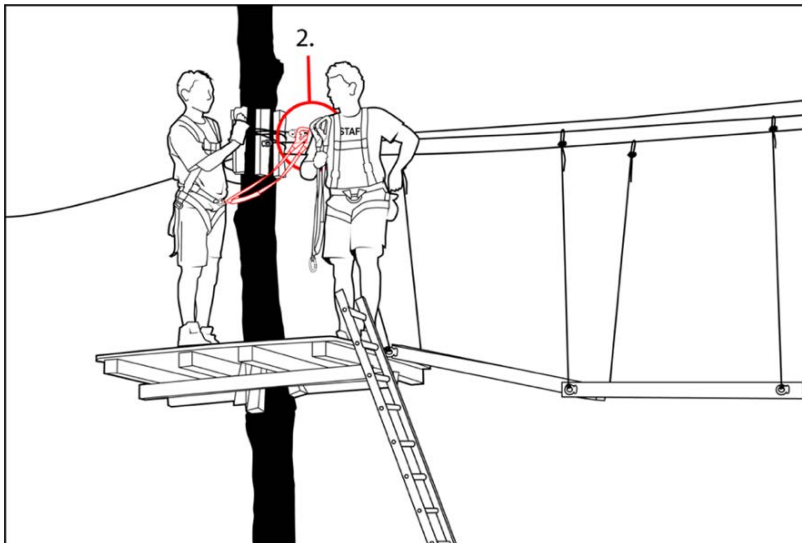

Figure 28: Replacement LockD Clips system to be installed with non-functioning system still connected

3. The replacement LockD Clips unit is attached to the user and the life safety line while the non-functioning unit continues to remain attached at the same time.
4. The harness connection of the non-functioning LockD Clips unit is de-connected.
5. The user is allowed to continue on the course.
6. The trained staff member removes the non-functioning unit from the life safety line using the carabiner Removing Tool.

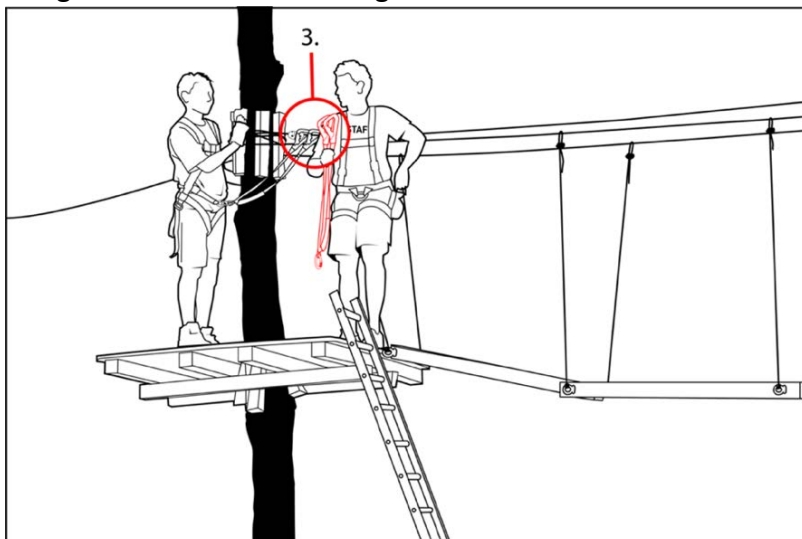

Figure 29: Non-functioning unit is detached from the user after the new unit is attached to the user and life safety line

7. This is done by sliding the carabiner Removing Tool between the carabiner body and the gate cover, engaging it around the locking pin, and pulling the locking pin upwards, towards the abrasion guard.
8. Once the non-functioning unit has been removed, it should be tagged accordingly, and the unit sent to the manufacturer or a manufacturer's representative for repair.

9. The system must not be used anymore and shall be sent to the producer or an authorized partner.



*Use safety gloves when handling with the rescue tool.
Only qualified trained staff should perform Beta Error
LockD Clips replacement in life safety situations.*

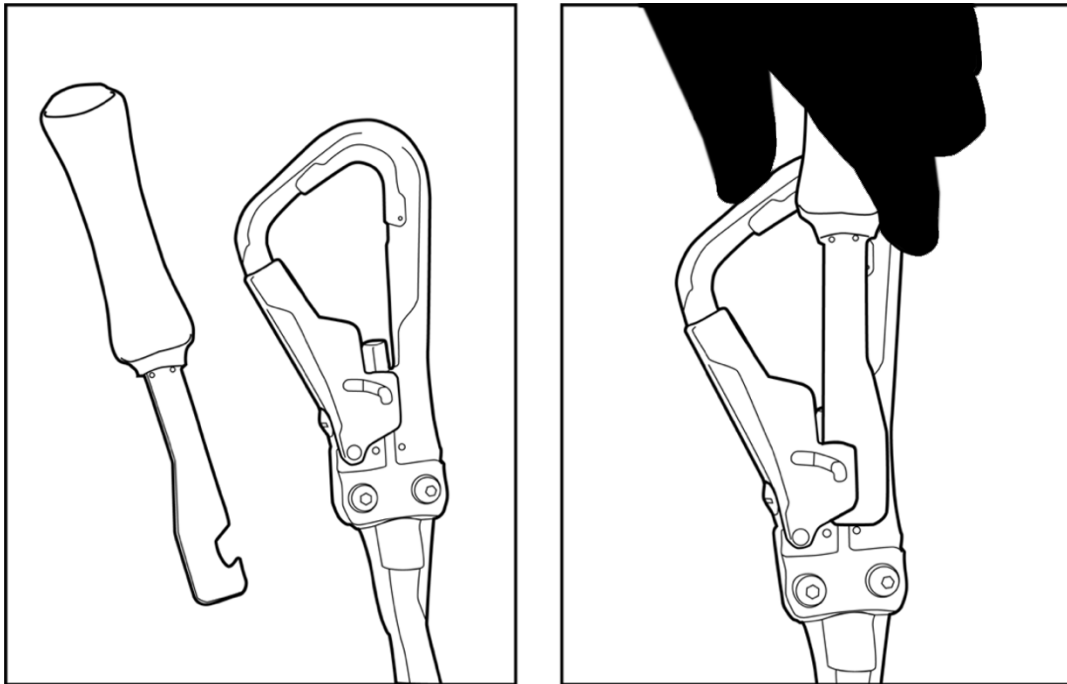

Figure 30: Use of the Carabiner Removing Tool with safety gloves

8. Cleaning and Storage

8.1. Storing LockD Clips After Use

Once LockD Clips have been returned from use, and especially if moisture is present, units should be stored on hooks with the carabiners hanging downwards to be able to shed moisture and dry. Drying should be done naturally, avoiding mechanical heat sources.

8.2. Cleaning

8.2.1. Cleaning of Textile Parts

Textile parts should be carefully brushed with a soft brush when dirty, or cleaned with lukewarm water and mild dishwashing detergent, then rinsed with tepid water. Do not use other cleaning agents as they may adversely affect the strength of the textile.

8.2.2. Removing Foreign Matters

LockD Clips may be exposed to dirt and foreign objects during use, requiring their removal. Removing foreign matters is best done when LockD Clips are dry. Remove dirt and debris with a soft brush, turning the units to allow debris to fall out as needed.

Gently tap with hand or wooden spoon to knock out stubborn debris pieces if necessary.

8.2.3. Cleaning with Moisture

If moisture is required for stubborn cleaning requirements, the metal parts can be cleaned with a damp cloth and mild dishwashing detergent or dry-steamed with a commercial dry-steaming machine. Avoid using running water or spray detergents. Prevent water from entering the locking housing unit or any part of the communication system by always cleaning away from the opening of the locking housing unit.

8.2.4. Lubrication and Oiling

Lubrication and oiling of the components should always be done after cleaning. Dry lubricants are recommended. Avoid excessive use of liquid oils to prevent adhesion of contaminants (ie. dirt, dust, sand) to the oils. Only resin, silicone and acid-free lubricants may be used.

8.3. Storage

Cleaning and lubrication should be done before any long-term storage (wintering). Long term storage should take place in a cool and dry environment, out of light and heat sources. Care should be taken to protect LockD Clips from coming into contact with any chemicals and always protect from insect and rodent damage.

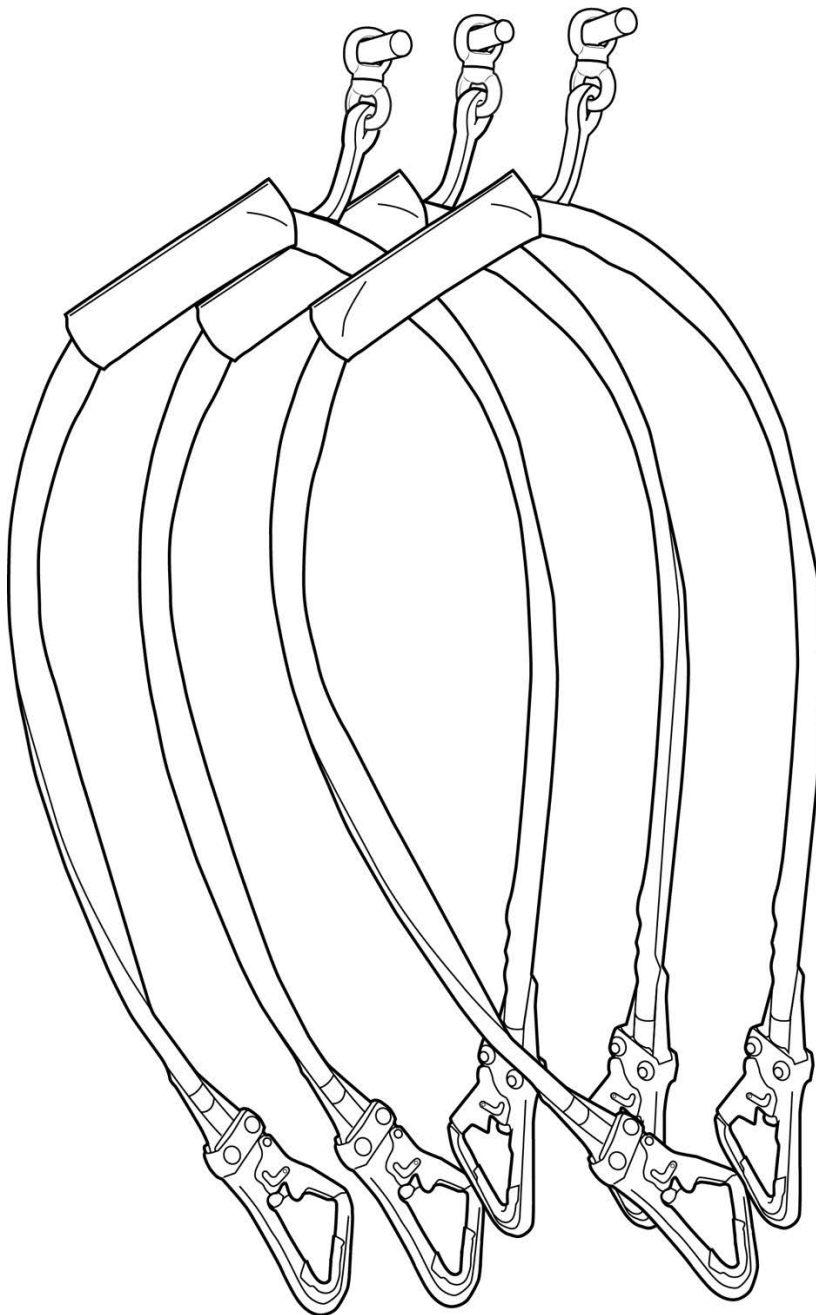

Figure 31: Storage after use.

8.4. Use after prolonged storage

Check to make sure all LockD Clips coming out of storage have remained cool and dry and there are not any signs of vandalism, rodent damage, and especially, any signs of chemical damage.

If it cannot be assured that chemical damage has occurred or not, the LockD Clips must not be put into service, marked to indicate potential chemical damage, and sent to the manufacturer or a manufacturer's representative for inspection.

9. Repair

Repairs may only be carried out by the manufacturer or its authorized representative. The replacement of the wear parts, including abrasion guard and gate springs may be done by the ropes course operator following manufacturer's instructions.

All replacement parts must be original manufacturer parts.

<i>Activity</i>	<i>Ropes Course Operator</i>	<i>Dealer DLR</i>	<i>Distribution- and Service Partner DSP</i>	<i>Manufacturer</i>
<i>Insertion and removal of gate spring</i>	<i>yes, see 7.4</i>	<i>yes</i>	<i>yes</i>	<i>yes</i>
<i>Removal & Replacement of abrasion guard</i>	<i>yes, see 7.5</i>	<i>yes</i>	<i>yes</i>	<i>yes</i>
<i>Cleaning the system</i>	<i>yes, see 8.2</i>	<i>yes</i>	<i>yes</i>	<i>yes</i>
<i>Lubricating the system</i>	<i>yes, see 8.2.4</i>	<i>yes</i>	<i>yes</i>	<i>yes</i>
<i>Installation of Tweezle & Tweezle o</i>	<i>yes, see 3.1</i>	<i>yes</i>	<i>yes</i>	<i>yes</i>
<i>Connecting LockD Clips and climbing harness</i>	<i>yes, see 4</i>	<i>yes</i>	<i>yes</i>	<i>yes</i>
<i>Removing carabiner hooks from textiles lanyards</i>	<i>no</i>	<i>yes</i>	<i>yes</i>	<i>yes</i>
<i>Mounting and demounting of the communication system</i>	<i>no</i>	<i>yes</i>	<i>yes</i>	<i>yes</i>
<i>Removing plug-in unit</i>	<i>no</i>	<i>yes</i>	<i>yes</i>	<i>yes</i>
<i>Mounting threaded top</i>	<i>no</i>	<i>yes</i>	<i>yes</i>	<i>yes</i>
<i>Opening the Banana</i>	<i>no</i>	<i>no</i>	<i>yes</i>	<i>yes</i>
<i>Adjusting the Bowden cable</i>	<i>no</i>	<i>no</i>	<i>yes</i>	<i>yes</i>
<i>Expansion of the plug-in unit</i>	<i>no</i>	<i>no</i>	<i>yes</i>	<i>yes</i>
<i>Removal of gate or gate pin</i>	<i>no</i>	<i>no</i>	<i>no</i>	<i>yes</i>
<i>Manipulation of Swivel</i>	<i>no</i>	<i>no</i>	<i>no</i>	<i>yes</i>
<i>Any other procedure not listed</i>	<i>no</i>	<i>no</i>	<i>no</i>	<i>yes</i>

If unauthorized changes, repair or replacement is done to LockD Clips, the guarantee will be void and safety of the system may be in jeopardy.

10. Other safety regulations



Risk of serious injury or death can occur if the safety instructions are not followed as written.

- Stop use of LockD Clips if any defects are detected or observed.
- Immediately remove damaged safety related devices from use, all safety related equipment should be checked by the manufacturer or a manufacturer's representative. Observe all service requirements related to safety equipment as directed by the operating manual.
- The harness and all safety systems are part of personal protective equipment, and their proper use and maintenance should be designated to a specific person.
- The personal protective equipment and all safety devices may only be used by trained individuals who become familiar with their use and are aware of the dangers associated with their use.
- Accessories from other manufacturers may only be used with the consent of the manufacture and must not effect the functionality and safety of any other safety system.
- Appropriate clothes and shoes must be worn, keeping weather conditions in mind.
- Harness should be worn according to manufacturer's directions, keeping clothing layers in mind.
- LockD Clips can only be used with a Tweezle, its designated key. The Tweezle must only be used on designated life safety lines following jurisdictional standards and designed for the appropriate load and their location on the ropes course.
- Safety equipment should only be used by a competent individual.
- Fall arrest devices/systems require specific installation and use procedures and height clearances. Prior to use, make sure all procedures are observed.
- Determine possible fall clearances per jurisdictional regulations and equipment manufacturer operations manual.
- Protect life safety lines, harnesses, and all accessories from fire and flames, from sharp edges and objects, sparks of any kind, and chemical compounds.
- Follow all insurance requirements and local employees ordinances and safety procedures.
- Trees as structural support structures are "living bodies" and will require care and maintenance. If left unchecked, their growth can cause changes and distortions on the life safety lines. Check their integrity after storms, floods and hurricanes.
- An emergency action plan (rescue and evacuation plan) must be in place and practiced by the operation. Specific rescue plans and first aid should be in place in case of emergencies. The manufacturer can provide guidance to creating emergency action plans and provide staff training.

11. Supplemental Issues

11.1. Conforming Standards

Conforms with:	EC Directive 89/686/EWG
Product certification according to:	EN 17109:2020, Category D
Testing and production approvals by:	TÜV Austria CE0408 Deutschstraße 10 Austria 1230 Vienna

11.2. Sales and Translations

Distributors and dealers must ensure that the instructions for use are supplied in the language of the respective country of destination if German or English are not sufficient. The translation must be authorized/approved by the manufacturer.

11.3. Regular Checks

- Carry out visual and functional tests before each use.
- Check harnesses, anchors, cable/rope terminations, and all mechanical devices regularly, and at least once a year by a qualified inspector, and document the results on the test card.
- Wear is to be expected and will depend on amount and frequencies of use. Inspections must be performed accordingly.

11.4. Life of Product

- Use purchased slings, cowtails, and other textile material within 3 years of purchase.
- Maximum service life for slings, cowtails and other textile material is 10 years.
- The above-mentioned maximum service life is reduced if the materials have been exposed to damaging heat, temperatures, undue stress including excessive falls, damage due to abrasion, cuts, and chemical agents. Each of the influencing factors above can differently effect life span depending on the intensity, duration of influence and their combination. The influences can occur during use as well as during transport or storage. The decision to retire an item will have to be made by a qualified person trained in the corresponding technical field. Intensive use and/or extreme operating conditions such as use on sharp edges, chemical influences, etc. lead to a reduced service life. The operator must ensure compliance.
- Document the first use of any product to facilitate compliance with its operating requirements and maintenance.
- Using the test card included in this manual may aide documentation requirements of course inspectors.

12. Annual Monitoring by Qualified Individuals

12.1. Inspection Criteria

The periodic inspection of PPE for falls from height must be performed by a qualified inspector per jurisdictional standards of your region.

12.2. Inspection Procedures

Please familiarize yourself fully with the instructions manual before performing any inspections.

When re-inspecting, please reference previous inspections.

The inspection report templet should not be considered as encompassing all the criteria of an inspection. Additional criteria should be noted elsewhere if needed.

Each templet may be used for inputting information for up to 5 LockD Clips units.

The following 1-4 rating system is recommended for imputing inspection results:

Legend / Inspection Information

1 minimal wear great	2 slightly worn good	3 heavily worn adequate	4 Excessively worn needs replacement
--------------------------------	--------------------------------	-----------------------------------	--

In case of a 3 or 4 rating, please provide further information on the back of the form.

A 4 rating requires the LockD Clips unit to be separated and marked for repair / replacement.

Sorting according to repair types, whether it can be performed in-house or not, will facilitate decisions to be made by the operator. For example, replacement of the abrasion guard and carabiner gate spring, verses devices that must be sent to the manufacturer or a manufacturer's representative.



If in doubt, remove the LockD Clips unit from use!

Inspection reports must be kept within reach of the operator and inspector, preferably in a folder with the instructions manual.

12.3. Inspection Report Templet

Please refer to the next page.

Inspection Report Template. Please refer to the instructions for use.

Name of Inspector	Inspection Date
--------------------------	------------------------

Operating manual available?	Expiration Date (10 years from purchase date)	Sheet #
-----------------------------	---	---------

Serial number (eight digits)					
Batch number (four digits)					
State of the carabiner body					
Condition of abrasion guard					
Condition of gate					
Gate open / close performance					
Gate auto-closing					
Screw connections					
Batch number (four digits)					
State of the carabiner body					
Condition of abrasion guard					
Condition of gate					
Gate open / close performance					
Gate auto-closing					
Screw connections					
Condition of webbing					
Short arm stitching					
Long arm stitching					
Stitching of loop					
Banana cover condition					
Swivel					
Legibility of ID label					
Standard tweezing					
Unconventional tweezing					
Audible noise when tweezing					
Photos for verification (number/number)					
Passed for continued use					

Legend / Inspection Information				Inspector's Signature
1 minimal wear great	2 slightly worn good	3 heavily worn adequate	4 excessively worn needs replacement	

13. Your partner and direct contact for all kinds of questions



Ropes Park Equipment, LLC

1700 Post Rd. Suite C-16
Fairfield, CT
USA 06824

F 1-203-692-4644
E info@ropesparkequipment.com
www.ropesparkequipment.com



Ropes Park Equipment GmbH

Gaadnerstr. 90
2371 Hinterbrühl
Austria EU

E info@ropesparkequipment.eu
www.ropesparkequipment.eu

Your partner and direct contact for all questions: