

CDA SPECIAL
BOOTH # 2048
May 16-18

NEW **FREE** Apple - AirPods Pro - (White) with 300 Gold Burs

FREE with 450 Gold Burs Burs \$3.99 and up qualifying

Apple Watch 9 Or Latest Model **OR** iPad 10.9" Or Latest Model

Apple watch Ultra 2 (Or Latest model) **Free with 750 Gold Burs**

2000 REWARD POINTS ON GOLDBURS.COM
\$20 Value Just For Signing Up

“Since I've been getting all my burs from Goldburs.com, I'm saving 30% off the cost. Diagold is big enough to handle my business and small enough to care.”
Dr. Dan Rosen, Encino

24K GOLD PLATED DIAMOND BURS

ADVANTAGES:

- ✓ No corrosion, even under extreme conditions
- ✓ Decreases repairs & maintenance of handpiece, increasing turbine chuck life 30%-50%
- ✓ Generates less heat, cold smooth cut
- ✓ Self-lubricating, increasing stock removal rate
- ✓ Significant germ reduction, reduced risk of infection
- ✓ Impressive visual impact during procedure
- ✓ Lowest cost reusable diamond burs

SAFESHANK™
Warranty:
Hardened Stainless Steel Shanks
ø 1.597mm diameter
with strict tolerance for secure fit

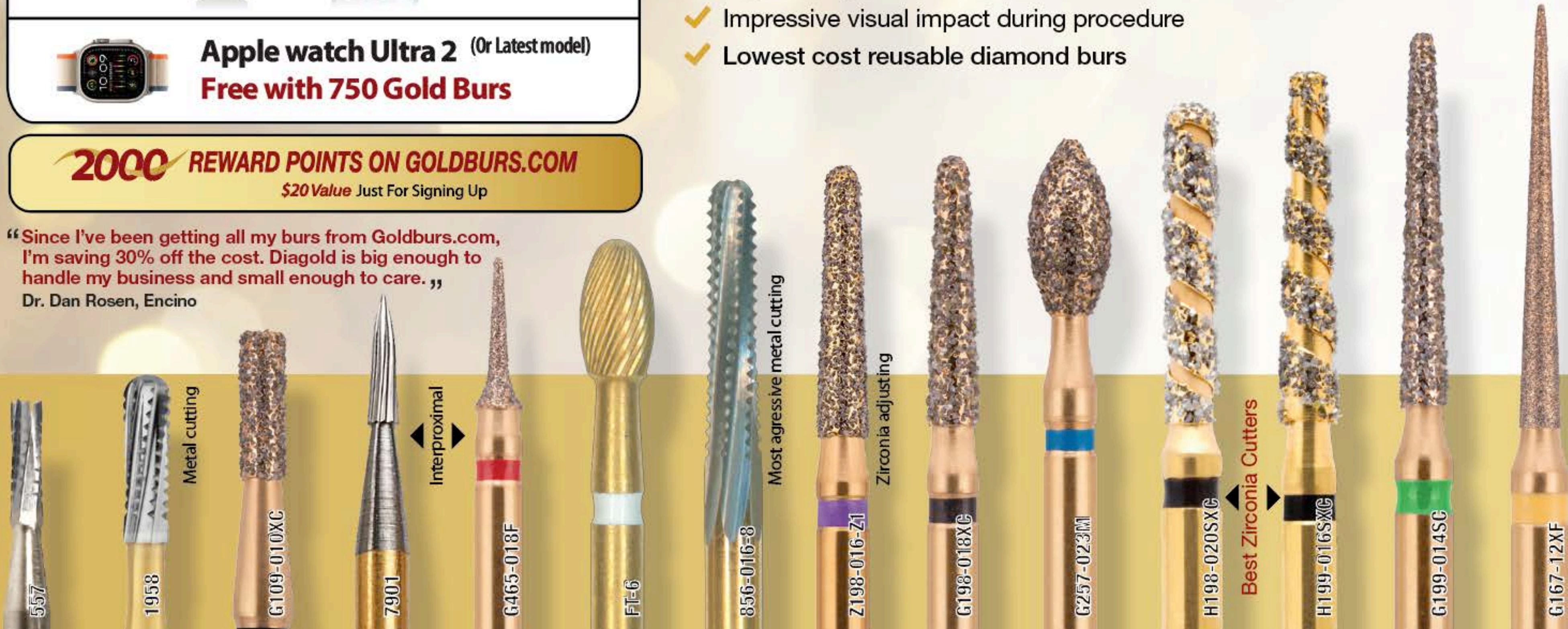

800-638-2877 Orders@GoldBurs.com

SPECIAL 60

**BUY 60 AND
GET 10 FREE**

70 at **\$3.56**ea

\$3.99 ea (in a 10pkg)

SPECIAL 100

**BUY 100 AND
GET 20 FREE**









































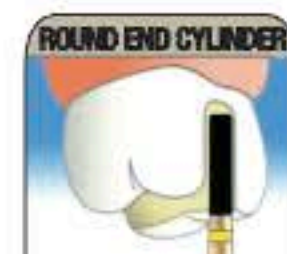









120 at **\$3.32**ea

2 Reward points for every dollar spent on GoldBurs.com

SPECIAL 200

**BUY 200 AND
GET 50 FREE**

250 at **\$3.19**ea

<p>ROUND (BALL)</p>  <p>Removal of old fillings Cavity preparation Crown preparation Surgery, Prophylaxis Root canal treatments</p> <p>\$4.69 ea</p>	<p>801</p>  <p>Removal of old fillings Cavity preparation Crown preparation Prophylaxis</p> <p>\$4.69 ea</p>	<p>INVERTED CONE</p>  <p>Removal of old fillings Cavity preparation Crown preparation Prophylaxis</p>	<p>805</p>  <p>Removal of old fillings Cavity preparation Crown preparation Prophylaxis</p>	<p>DIABLO</p>  <p>Cavity preparation Removal of old fillings Amalgam remover</p>	<p>813</p>  <p>Cavity preparation Removal of old fillings Amalgam remover</p>	<p>BARREL</p>  <p>Crown preparation Occlusal contouring Removal of old fillings</p> <p>\$4.99 ea</p>	<p>811</p>  <p>Crown preparation Occlusal contouring Removal of old fillings</p>													
<p>WHEEL</p>  <p>Crown preparation Occlusal contouring Removal of old fillings</p> <p>\$4.99 ea</p>	<p>909</p>  <p>Crown preparation Occlusal contouring Removal of old fillings</p>	<p>FLAT END CYLINDER</p>  <p>Removal of old fillings Cavity preparation Crown preparation Inlay/Onlay preparation Prophylaxis</p>	<p>835</p>  <p>Removal of old fillings Cavity preparation Crown preparation Inlay/Onlay preparation Prophylaxis</p>	<p>Zirconia Cutter</p>  <p>Removal of old fillings Cavity preparation Crown preparation Inlay/Onlay preparation Prophylaxis</p>	<p>836</p>  <p>Removal of old fillings Cavity preparation Crown preparation Inlay/Onlay preparation Prophylaxis</p>	<p>Zirconia Cutter</p>  <p>Removal of old fillings Cavity preparation Crown preparation Inlay/Onlay preparation Prophylaxis</p>	<p>Zirconia Cutter</p>  <p>Removal of old fillings Cavity preparation Crown preparation Inlay/Onlay preparation Prophylaxis</p>	<p>Zirconia Cutter</p>  <p>Removal of old fillings Cavity preparation Crown preparation Inlay/Onlay preparation Prophylaxis</p>	<p>Zirconia Cutter</p>  <p>Removal of old fillings Cavity preparation Crown preparation Inlay/Onlay preparation Prophylaxis</p>	<p>Zirconia Cutter</p>  <p>Removal of old fillings Cavity preparation Crown preparation Inlay/Onlay preparation Prophylaxis</p>	<p>Zirconia Cutter</p>  <p>Removal of old fillings Cavity preparation Crown preparation Inlay/Onlay preparation Prophylaxis</p>	<p>Zirconia Cutter</p>  <p>Removal of old fillings Cavity preparation Crown preparation Inlay/Onlay preparation Prophylaxis</p>	<p>Zirconia Cutter</p>  <p>Removal of old fillings Cavity preparation Crown preparation Inlay/Onlay preparation Prophylaxis</p>	<p>Zirconia Cutter</p>  <p>Removal of old fillings Cavity preparation Crown preparation Inlay/Onlay preparation Prophylaxis</p>	<p>Zirconia Cutter</p>  <p>Removal of old fillings Cavity preparation Crown preparation Inlay/Onlay preparation Prophylaxis</p>					
<p>837</p>  <p>Crown preparation Removal of old fillings Prophylaxis</p>	<p>BEVELED CYLINDER</p>  <p>Crown preparation Removal of old fillings Prophylaxis</p>	<p>885</p>  <p>Removal of old fillings Cavity preparation Crown preparation Ceramic Restorations Prophylaxis</p>	<p>838</p>  <p>Removal of old fillings Cavity preparation Crown preparation Ceramic Restorations Prophylaxis</p>	<p>880</p>  <p>Removal of old fillings Cavity preparation Crown preparation Ceramic Restorations Prophylaxis</p>	<p>881</p>  <p>Removal of old fillings Cavity preparation Crown preparation Ceramic Restorations Prophylaxis</p>															
<p>ROUND END CYLINDER</p>  <p>Removal of old fillings Cavity preparation Inlay/Onlay preparation Prophylaxis</p> <p>\$4.69</p>	<p>KS 1</p>  <p>Removal of old fillings Cavity preparation Inlay/Onlay preparation Prophylaxis</p>	<p>KS 2</p>  <p>Removal of old fillings Cavity preparation Inlay/Onlay preparation Prophylaxis</p>	<p>837</p>  <p>Removal of old fillings Cavity preparation Inlay/Onlay preparation Prophylaxis</p>	<p>837</p>  <p>Removal of old fillings Cavity preparation Inlay/Onlay preparation Prophylaxis</p>	<p>END CUTTING CYLINDER</p>  <p>Cavity preparation Crown preparation</p> <p>\$4.69 ea</p>	<p>839</p>  <p>Cavity preparation Crown preparation</p>	<p>839</p>  <p>Cavity preparation Crown preparation</p>	<p>839</p>  <p>Cavity preparation Crown preparation</p>	<p>NEEDLE TAPER</p>  <p>Removal of old fillings Cavity preparation Crown preparation Finishing</p>	<p>852</p>  <p>Removal of old fillings Cavity preparation Crown preparation Finishing</p>	<p>858</p>  <p>Removal of old fillings Cavity preparation Crown preparation Finishing</p>	<p>859</p>  <p>Removal of old fillings Cavity preparation Crown preparation Finishing</p>	<p>859</p>  <p>Removal of old fillings Cavity preparation Crown preparation Finishing</p>	<p>859</p>  <p>Removal of old fillings Cavity preparation Crown preparation Finishing</p>	<p>859</p>  <p>Removal of old fillings Cavity preparation Crown preparation Finishing</p>	<p>859</p>  <p>Removal of old fillings Cavity preparation Crown preparation Finishing</p>	<p>859</p>  <p>Removal of old fillings Cavity preparation Crown preparation Finishing</p>	<p>845</p>  <p>Removal of old fillings Cavity preparation Crown preparation Inlay/Onlay preparation Prophylaxis</p>	<p>846</p>  <p>Removal of old fillings Cavity preparation Crown preparation Inlay/Onlay preparation Prophylaxis</p>	<p>846</p>  <p>Removal of old fillings Cavity preparation Crown preparation Inlay/Onlay preparation Prophylaxis</p>



**60%
Diamonds
Exposure**

More Diamond Per Diamond

Zirconia Cutter				847				Zirconia Cutter				848				Zirconia Cutter				848L			
G/	G/	G/	H/	G/	G/	G/	G/	H/	G/	G/	G/	G/	G/	G/	H/	G/	G/	G/	G/	G/	G/		
171-016S	172-012	172-013S	172-014	172-014	172-015S	172-016	172-017S	172-018s	172-019S	172-023	173-014	173-016SH	173-016S	173-016L	173-017	173-018	173-018S	173-019	173-021S	174-013	174-022		
7	8	9	8	8	8	8.5	8	8	8	9	10	10	10	10	10	10	10	10	10	11.5	11.5		
18.5	22	20.5	22	22	19.5	22	19.5	22	19.5	22	24	18.5	21.5	24	24	24	24	21.5	24	21.5	24.5	24.5	

ROUND END TAPER

Removal of old fillings
Cavity preparation
Crown preparation
Inlay/Onlay preparation
Prophylaxis

855												Zirconia Cutter				856				Zirconia Cutter				
G/	G/	G/	G/	G/	G/	G/	G/	G/	G/	G/	G/	H/	G/	G/	G/	G/	G/	G/	H/	G/	G/	H/	G/	G/
196-020	196-026	197-012S	197-012L	197-014	197-016SH	197-017S	197-017	197-018S	197-018SH	197-019S	197-019S	197-020	197-023	197-024S	197-025	198-010	198-012	198-014S	198-014S	198-015	198-016S	198-016s	198-016L	198-017
4	4	7	6.5	6.5	6	7	6.5	7	6	7	7	7.0	7	7	7	8	8	8	8	8	8	8.0	8	8
19	19	18.5	21	21	16.5	18.5	21	18.5	16.5	18.5	18.5	18.5	21	18.5	21	22	22	19.5	19.5	22	20	19.5	22	22

856		Zirconia Cutter		Zirconia Cutter		Zirconia Cutter		850												Zirconia Cutter		Zirconia Cutter		850L					
G/	G/	H/	G/	H/	G/	G/	H/	G/	G/	G/	G/	G/	H/	G/	G/	G/	G/	H/	G/	G/	G/	G/	G/	G/	G/	G/	G/	G/	G/
198-018	198-019S	198-019S	198-019	198-020S	198-021	198-022	198-022	198-022S	198-025	199-010	199-012S	199-014S	199-014S	199-014L	199-015S	199-016SH	199-016S	199-016S	199-016L	199-016L	199-018	199-018	199-018	199-018	199-019S	200-016	200-022	200-024	
8	9	9	8.5	9	9	8.5	8.5	8.5	8	10	10	9	10	10	10	10	10	10	10	10	10	10	10	10	10	11	11.5	11.5	
22	20.5	20.5	22	20.5	22	22	22.5	20	22	24	22	22	22	24	22	18.5	22	21.5	24	22	24	24	24	22	24.5	24.5	24.5		

807		PEAR		830R					860					Zirconia Cutter									
G/	G/	G/	G/	G/	G/	G/	G/	G/	G/	G/	G/	G/	G/	G/	H/	H/	G/	G/	G/	G/	G/	G/	
225-013	225-019	225-019	225-019	237-009	237-010	237-012	238-012	238-014	238-014	247-013	247-016	248-014SH	249-010S	249-012S	249-012s	249-012-L	249-012L	249-014SH	249-014S	249-014	249-015S	249-015	
3.5	4	4	4	2	3	3	4	4	4	5	5	6.5	8	8	8	8	8	8	8	7.5	8	8	
19	19	19	19	19	19	19	19	19	19	19	19	17.5	20	10.5	19.5	22.5	22	18	19.5	22	19.5	22	

863 Zirconia Cutter



Removal of old fillings
Cavity preparation
Crown preparation
Inlay/Onlay preparation
Prophylaxis

\$4.69

G/	H/
249-016S	250-012s
8	10
19.5	21.5

368 Zirconia Cutter



Removal of old fillings
Cavity preparation
Crown preparation
Inlay/Onlay preparation
Prophylaxis

\$4.69

G/	H/
257-016	257-023
3.2	5
19	20

KSS



Removal of old fillings
Cavity preparation
Crown preparation
Contouring & Finishing

\$4.69

G/	H/
257-025	276-033
5	5
20	19

EGG



Removal of old fillings
Cavity preparation
Crown preparation
Contouring & Finishing

\$4.69

G/	H/
277-019	277-025
3.9	4.6
19	19

379



G/	H/
277-019	277-025
3.9	4.6
19	19

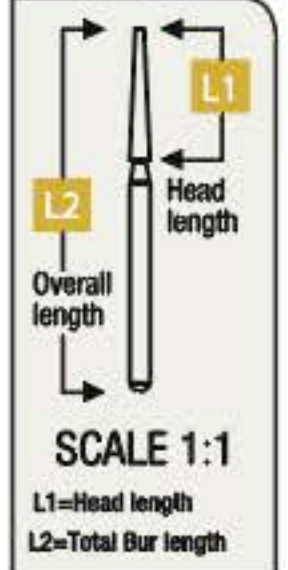

Overall length
Head length
SCALE 1:1
L1=Head length
L2=Total Bur length

877 TORPEDO



Removal of old fillings
Cavity preparation
Crown preparation
Prophylaxis

G/	H/
288-011	289-013
6	8
21	22

878



G/	H/
289-012S	289-014S
8	8
19.5	16

879



G/	H/
289-015S	290-012
8	9.5
20	24

877K COURRETTAGE



Removal of old fillings
Cavity preparation
Crown preparation
Prophylaxis

\$4.69

G/	H/
297-017SH	298-014S
6.5	8
17	20

878K



G/	H/
298-013S	298-014S
8	8
20	20

Zirconia Cutter



H/
298-014s
8
20

Zirconia Cutter



G/	H/
298-016s	298-016s
8	8
20	20

Zirconia Cutter



G/	H/
298-016L	298-016L
8	8
20	20

Zirconia Cutter



H/
298-016-L
8
22.5

Zirconia Cutter



G/	H/
298-018S	298-018S
8	8
20	20

Zirconia Cutter



H/
298-018s
10
24

878K



G/	H/
298-023S	299-012S
8	10
20	22

879K Zirconia Cutter



G/	H/
299-013	299-018
9.5	10
24	24

ROUND EDGE TAPER



Removal of old fillings
Cavity preparation
Crown preparation

\$4.69

G/	H/
299-020S	299-020S
10	10
21.5	21.5

845KR



G/	H/
544-019S	544-026S
4	4
18	18

846KR



G/	H/
545-017SH	546-017S
6	8
16.5	20

847KR



G/	H/
546-020S	546-020S
8	8
20	20

INTERPROXIMAL



Removal of old fillings
Cavity preparation
Crown preparation
Prophylaxis

\$4.69

G/	H/
465-016	465-018
5	5
19	19

392



G/	H/
465-016	465-018
5	5
19	19

833



H/
466-031
3.5
16

804



H/
473-099
0.9
16

FLAME NEEDLE



Removal of old fillings
Cavity preparation
Crown preparation

\$4.69

G/	H/
536-010S	539-007
3	3
17	22

SUPER SHORT



G/	H/
539-010	540-010
3	4
20	23

RC/RT **EXTRA LARGE HEAD \$4.99ea**



Gross Reduction
Fillings + Crowns

\$4.69

G/	H/
513-017S	514-018
7.8	9.5
20	22

G/	H/
517-018S	519-018S
6.5	8.2
19	20

G/	H/
521-019S	001-042
10	4.2
22	19

G/	H/
033-027	039-048
7	7
21	22

G/	H/
041-017	041-027
1	1
19	19

G/	H/
041-035	041-038
0.7	0.8
19	19

G/	H/
041-050	055-042
2	0
19	19

G/	H/
161-038	237-032
7	5
21	19

G/	H/
163-030	163-030
3.8	3.8
19	19

Cone \$5.99

Zirconia Crown Cutting and Adjusting: \$5.99ea



ZirconIT
Crown Cutting

Z001	Z141	Z141	Z167	Z198	Z198L	Z198	Z225	Z276	Z277	Z298	Z298
022	012	014	010	016	016	021	018	031	023	014	021
L1	2.2	8	8	11.5	8	9	8	5	6.2	4.5	8
L2	19	21	22	24	20	22	22	19	20	19	21

XC EXTRA-COARSE
 C COARSE
 M MEDIUM
 F FINE
 XF EXTRA-FINE
 UF ULTRA-FINE

Grits marked in a box are available only in stainless steel shank

\$4.99ea

LONG / SURGICAL
801LP
\$4.39ea

PIN GUIDE
\$5.99ea

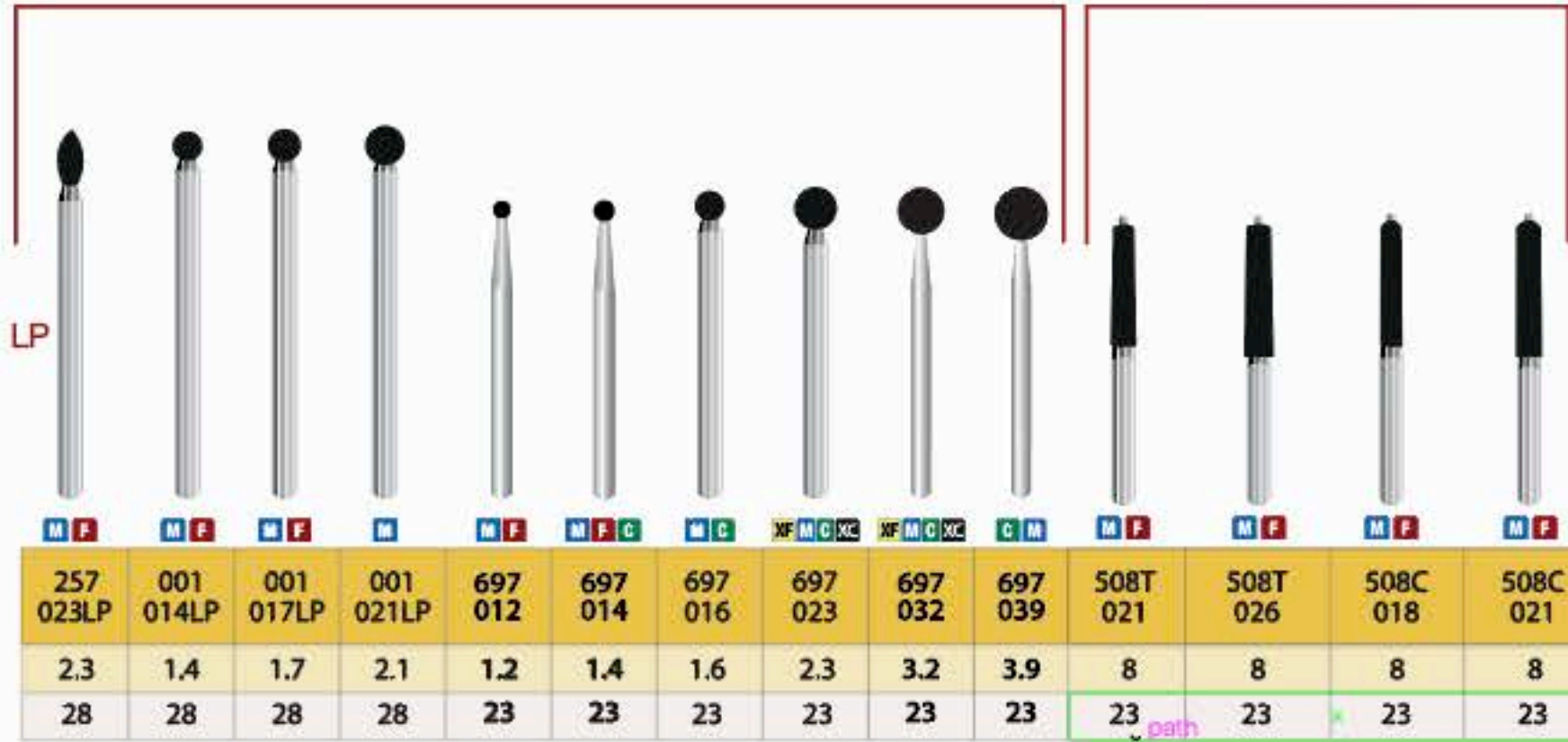

M F	M F	M F	M	M F	M F C	M C	XF M C XC	XF M C XC	C M	M F	M F	M F	M F
257 023LP	001 014LP	001 017LP	001 021LP	697 012	697 014	697 016	697 023	697 032	697 039	508T 021	508T 026	508C 018	508C 021
2.3	1.4	1.7	2.1	1.2	1.4	1.6	2.3	3.2	3.9	8	8	8	8
28	28	28	28	23	23	23	23	23	23	23	23	23	23

ORDER #: ENDO KIT
\$79.00

ENDO KIT 8 Diamonds & 4 Carbides Combo kit
In an auto clavable block



ENDO DIAMONDS & CARBIDES \$5.95ea

370 Occlusal Reduction

Safe End Diamond Burs

Safe End

Endo Carbides

F M C	C	C	C	C	C	C	XF	XF	M F	M F	M	M	F	F	F	F
507 023	E164 011	E164 015	E164 018	E165 014	E165 014L	E190 019	E216 010	E218 016	E219 012	E219 016	E220 014	E220 016	152EZ	151EZ	219EZ	199Z
6	10	10	10	9	9	9.5	3	6	8	8	10	10	8	11	9	10
21	21	21	21	21	25	21	N/A	N/A	22	22	24	24	21	25	23	23

Depth Markers \$5.99ea

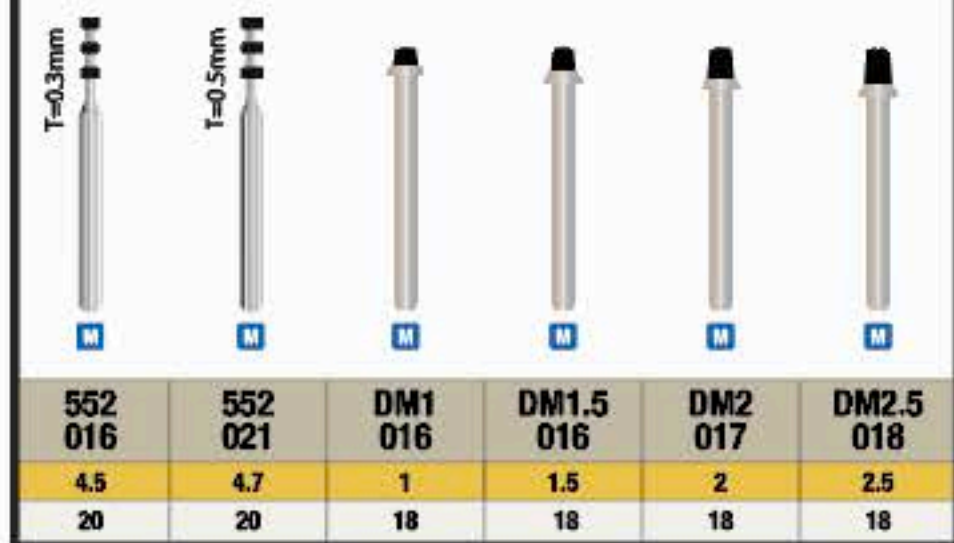

M	M	M	M	M	M
552 016	552 021	DM1 016	DM1.5 016	DM2 017	DM2.5 018
4.5	4.7	1	1.5	2	2.5
20	20	18	18	18	18

Shank 2.35mm 3/32 inch



RA - Diamond Burs For Latch Type Contra Angle Slow Speed Handpiece \$3.99 ea

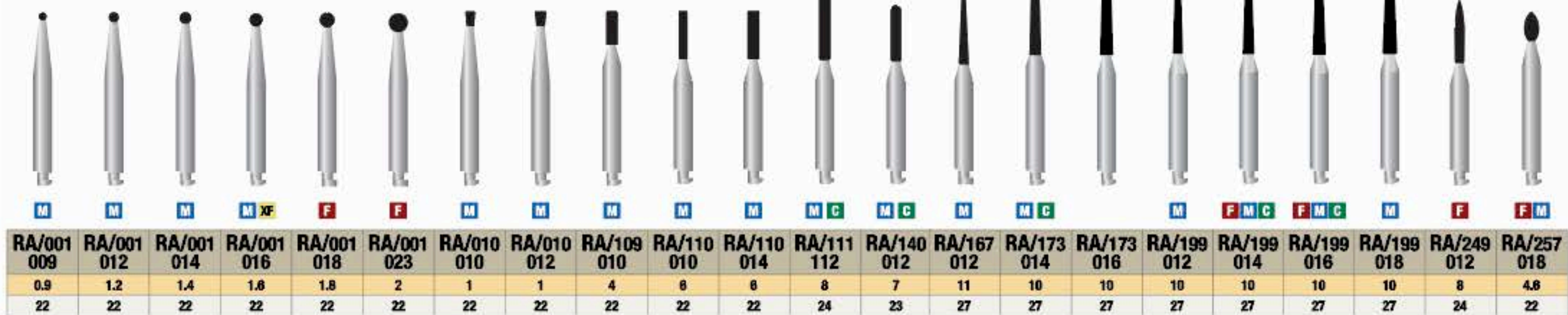

M	M	M	M XF	F	F	M	M	M	M	M	M	M C	M C	M	M C	M	M	F M C	F M C	M	F	F M
RA/001 009	RA/001 012	RA/001 014	RA/001 016	RA/001 018	RA/001 023	RA/010 010	RA/010 012	RA/109 010	RA/110 010	RA/110 014	RA/111 112	RA/140 012	RA/167 012	RA/173 014	RA/173 016	RA/199 012	RA/199 014	RA/199 016	RA/199 018	RA/249 012	RA/257 018	
0.9	1.2	1.4	1.8	1.8	2	1	1	4	8	6	8	7	11	10	10	10	10	10	10	8	4.8	
22	22	22	22	22	22	22	22	22	22	22	24	23	27	27	27	27	27	27	27	24	22	

Minimal Invasive Burs

Micro Prep Long Thin Neck Burs

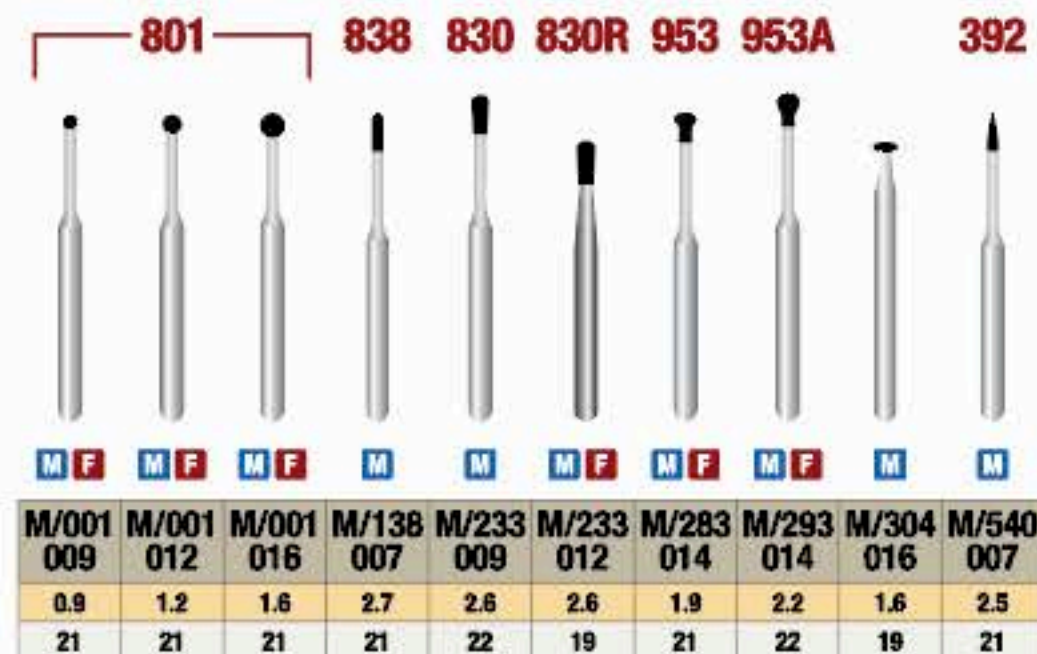

801	838	830	830R	953	953A	392			
M F	M F	M F	M	M	M F	M F	M F	M	M
M/001 009	M/001 012	M/001 016	M/138 007	M/233 009	M/233 012	M/283 014	M/293 014	M/304 016	M/540 007
0.9	1.2	1.6	2.7	2.6	2.6	1.9	2.2	1.6	2.5
21	21	21	21	22	19	21	22	19	21

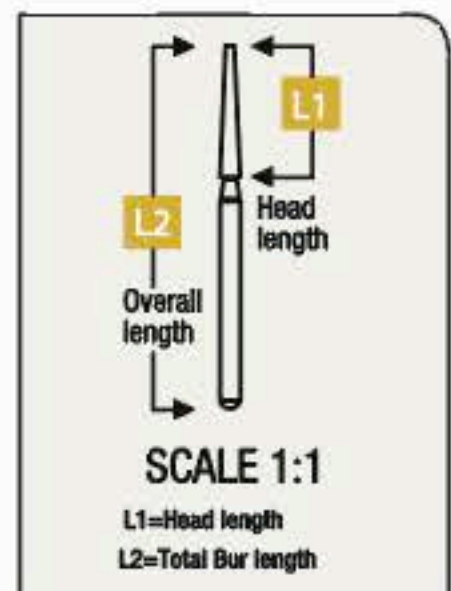

PEDO Super Short Shank Diamond Burs
(14mm to 17mm for small mouth) **\$3.69 ea**

PEDO
KIT #12
Page 10

14mm to 17mm
\$39.00

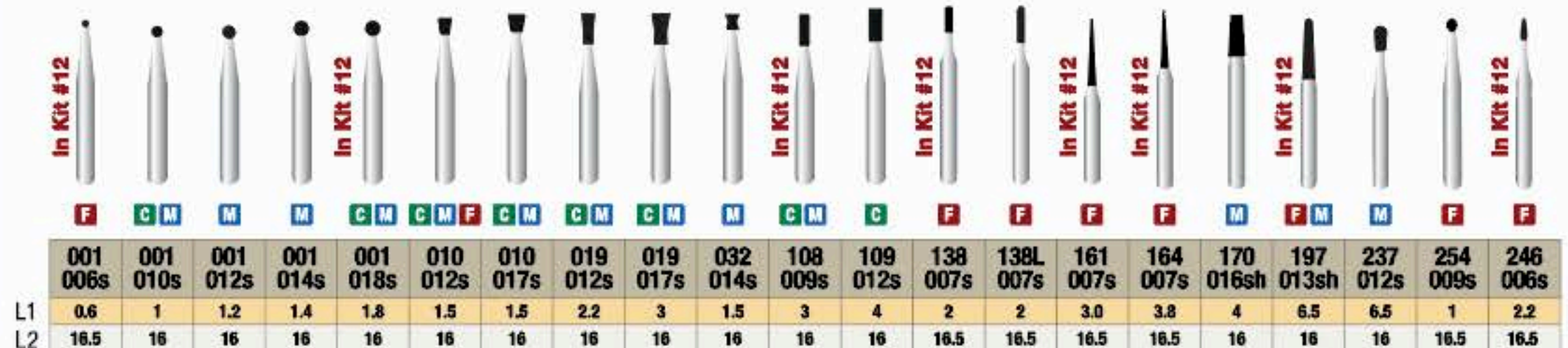
In Kit #12	In Kit #12	In Kit #12	In Kit #12	In Kit #12	In Kit #12	In Kit #12	In Kit #12	In Kit #12	In Kit #12	In Kit #12	In Kit #12	In Kit #12	In Kit #12	In Kit #12	In Kit #12	In Kit #12	In Kit #12	In Kit #12	In Kit #12	In Kit #12	In Kit #12
F	C M	M	M	C M	C M	F	C M	C M	C M	M	C M	C	F	F	F	F	M	F M	M	F	F
001 006s	001 010s	001 012s	001 014s	001 018s	010 012s	010 017s	019 012s	019 017s	032 014s	108 009s	109 012s	138 007s	138L 007s	161 007s	164 007s	170 016sh	197 013sh	237 012s	254 009s	246 006s	
0.6	1	1.2	1.4	1.8	1.5	1.5	2.2	3	1.5	3	4	2	2	3.0	3.8	4	6.5	6.5	1	2.2	
L1 16.5	16	16	16	16	16	16	16	16	16	16	16	16.5	16.5	16.5	16.5	16	16	16	16.5	16.5	

Trimming & Finishing Burs (12 Fluted) \$4.95ea Buy 60 get 10 FREE 70 @ \$4.24ea Mix & Match Page 6

Round Concave Taper Round End Inverted Taper Needle

	7002	7003	7004	7006	7008	7009	7103	7204	7205	7206	7702	7713	7283	7642	7664	7303	7304	7901	7902	7903	7572
Dia	1	1.2	1.4	1.8	2.3	2.7	1.2	1.4	1.6	1.8	1	1.2	1.5	1	1.5	1.7	1.4	3.6	1	1.2	1
L1	1	1.2	1.4	1.8	2.3	2.7	3.4	9	9	9	5.3	5.3	10	6.5	8	4	5	3.6	3.6	3.6	5
L2	19	19	19	19	19	19	19	24	24	24	21	25	23.5	21	23.5	21.5	21.5	19	19	19	21.5

Egg Bullet Flame Taper Finishing Inter-proximal Safe End C&B Chamfer

	7404	7406	7408	7801	7802	7803	9803	7104	7106	7108	7114	7214	7714	7610	7611	7612	7613	EF3	EF4	EF6	EF9	7345
Dia	1.4	1.8	2.3	0.9	1	1.2	1.2	1.4	1.8	2.3	0.9	1	1.4	0.8	1	1.4	1.4	0.8	0.8	0.8	0.8	1.5
L1	3.1	3.5	4.2	3.1	3.6	3.6	3.6	3.4	3.9	4.4	2.9	5.1	7.6	3.5	3.9	5.9	8.8	3	4.2	6	9	0
L2	19	19	19	19	19	19	19	19	19	19	23	21	23	19	19	20	22	21	21	21	25	21.5

Polishing Burs (30 Fluted) \$5.95ea Buy 60 get 10 FREE 70 @ \$5.10ea Mix & Match

	9004	9006	9008	9103	9214	9714	9404	9406	9408	CT6 12FL	ET6 16FL	FT6 30FL	9561	9572	9713	9642	9716	9214	9714	9903	9904	UF3	UF4	UF6	UF9
Dia	1.4	1.8	2.3	1.2	1	1.4	1.4	1.8	2.3	2.3	2.3	2.3	0.9	0.9	1.2	1	2.3	1	1.4	1.2	1.4	0.8	0.8	0.8	0.8
L1	1.4	1.8	2.3	3.4	5.1	7.6	3.1	3.5	4.2	4.2	4.2	4.2	3.4	4t	5.3	6.5	3.9	5.1	7.6	3.6	3.6	3	4.2	6	9
L2	19	19	19	19	21	23	19	19	19	19	19	19	19	19	25	21	19	21	23	19	19	21	21	21	25

Finishing & Polishing Diamond Burs \$3.99 ea

XF Extra Fine diamonds (26-38 microns) = (equal to) 12 bladed carbides \$4.95 ea
 UF Ultra Fine diamonds (15 microns) = (equal to) 30 bladed carbides \$5.95-\$7.95 ea

UF XF	UF XF	UF XF	UF	UF XF	UF XF	UF XF	UF XF	UF XF	UF	UF XF	UF XF	UF XF	UF	UF XF	UF	UF XF	UF	UF XF	UF XF	UF	UF XF	
001	001	164	164	165	165	166	166	167	171	247	249	249	249	250	250	257	257	257	257	257	257	539
018	023	012	014S	014S	014	014S	016	012	016	014	012	012S	014	012S	014	016	018	020	023	025	007	
1.8	2.3	6	6	8	8	10	10	11.5	6	5	8	8	8	10	10	3.2	4.6	4.6	5	5	3	
19	19	21	19	19.5	22	21.5	24	24.5	21	19	22.5	19.5	22	21.5	24	19	20	20	20	20	22	

Flame Burs Torpedo

274H	48L 10H	G/48L 12H	S/48L 12H	284	283	7-283 k6	7282 k6
1.8	1	1.2	1.2	1.4	1.2	1.2	1.4
3.5	8	8	8	8	8	8	4
19	19	19	19	22	22	23	21

Diamond Coated Stainless Steel Flexible Strips

\$5.99ea 10PK

- 10 strips per pack
- All Strips with 19mm Gap
- No sharp edges
- Uniform diamond coating
- Color coded with grit
- Autoclavable & Sterilizable for prolonged efficiency

Serrated Saw - One sided W/6.0mm

Perforated - Single sided Diamond Strips	Order	Grit	Length	Thickness	Width
W/2.5 mm	SSP-25XF	XF	148.0	0.11	2.5
	SSP-25F	F	148.0	0.12	2.5
	SSP-25M	M	148.0	0.14	2.5
W/4.0 mm	SSP-40XF	XF	148.0	0.11	4.0
	SSP-40F	F	148.0	0.12	4.0
	05P/SSP-40M	M	148.0	0.14	4.0
Serrated Saw - One sided W/6.0mm	05P/SBS-000		150.0	0.05	6.0

Actual size 148mm

Solid - Single sided Diamond Strips	Order	Grit	Length	Thickness	Width
W/3.7 mm	OSS-37M	M	148.0	0.14	3.7
	OSS-37C	C	148.0	0.21	3.7

Available in **F** **XF**

Solid - Double sided Diamond Strips

W/2.5 mm	DSS-25M	M	148.0	0.21	2.5
W/4.0 mm	DSS-40M	M	148.0	0.21	4.0

iGlo™ Silicon Polisher

\$2.99ea (10 pk) Buy 20 get 10 FREE

COMBO KIT 30 POLISHERS / mix & match
\$59.80 PG-01 30 Polishers Kit
 (cup, disc, point)

10 PK / ea size
\$2.99ea PG-02 Polishing cup
\$2.99ea PG-03 Polishing Disc
\$2.99ea PG-04 Polishing Point

G10 Brush



Brownie & Greenie Points

12 pcs pkg
\$32.95
 72 pcs pkg
\$159.95

	Shape	Cup	Mini-Point
ISO. No	CA12pcs	0401	0403
Brownie (Prepolish)	FG12pcs	0411	0413
Greenie (Prepolish)	CA12pcs	0402	0404
	FG12pcs	0412	0414

White & Green Polishing Stones

BesQual



12 pcs pkg

FG \$1.00ea	FG-CN1	FG-CY1	FG-FL2	FG-FL3	FG-RD1	FG-IC1
RA \$1.35ea	RA-CN1	RA-CY1	RA-FL2	RA-FL3	RA-RD1	RA-IC1
FG \$2.19ea	0241	--	0244	--	0247	--
RA \$2.29ea	0221	--	0223	0224	0227	--
FG \$1.00ea	FG-CN1	FG-CY1	FG-CY2	FG-FL2	FG-IC1	FG-TC1
RA \$1.35ea	RA-CN1	RA-CY1	RA-CY2	RA-FL2	RA-IC1	RA-TC1

ZIRCONIA CERAMIC CUTTERS

(HP SHANK 3/32"/2.35mm)

\$23.50ea

EXTREMELY LONG LIFE
 10 X TRADITIONAL CUTTERS



Round

	0.5	0.6	0.8	1.0	1.2	1.4	1.6	1.8	2.1	2.3
Order #:	FG 1/4	FG 1/2	FG 1	FG 2	FG 3	FG 4	FG 5	FG 6	FG 7	FG 8
FGSS:	FGSS 1/4	FGSS 1/2	FGSS 1	FGSS 2	FGSS 3	FGSS 4	FGSS 5	FGSS 6	---	FGSS 8
RA:	RA 1/4	RA 1/2	RA 1	RA 2	RA 3	RA 4	RA 5	RA 6	RA 7	RA 8
HP:	HP 1/4	HP 1/2	HP 1	HP 2	HP 3	HP 4	HP 5	HP 6	HP 7	HP 8
FG SURGICAL:	FGOS 1/4	FGOS 1/2	FGOS 1	FGOS 2	FGOS 3	FGOS 4	---	FGOS 6	---	FGOS 8
RA SURGICAL:	RAOS 1/4	RAOS 1/2	RAOS 1	RAOS 2	RAOS 3	RAOS 4	RAOS 5	RAOS 6	RAOS 7	RAOS 8

Straight Fissure

	0.9	1.0	1.2	1.4	1.6	0.9	1.0	1.2
Order #:	FG 56	FG 57	FG 58	FG 59	FG 60	FG 56L	FG 57L	FG 58L
FGSS:	FGSS 56	FGSS 57	---	---	---	---	---	---
RA:	RA 56	RA 57	RA 58	RA 59	---	---	---	---
HP:	HP 57	HP 58	---	---	---	---	---	---

All Purpose

	0.9	1.0
Order #:	FG 256	FG 257
FGSS:	---	---
RA:	---	---
HP:	---	---

Amalgam Prep

	0.9	1.2
Order #:	FG 245	FG 246
FGSS:	FGSS 245	---
RA:	RA 245	---
HP:	---	---

Pear

	0.6	0.8	1.0	1.2	1.0	1.2	1.4
Order #:	FG 329	FG 330	FG 331	FG 332	FG 331L	FG 332L	FG 333L
FGSS:	FGSS 329	FGSS 330	FGSS 331	FGSS 332	---	---	---
RA:	---	---	---	---	---	---	---
HP:	---	---	---	---	---	---	---
FG SURGICAL:	---	---	---	---	---	---	---
RA SURGICAL:	---	---	---	---	---	---	---

Straight Fissure Crosscut

	0.9	1.0	1.2	1.4	1.6	0.9	1.0	1.2
Order #:	FG 556	FG 557	FG 558	FG 559	FG 560	FG 556L	FG 557L	FG 558L
FGSS:	FGSS 556	FGSS 557	FGSS 558	---	---	---	FGSS 557L	FGSS 558L
RA:	RA 556	RA 557	RA 558	---	---	---	---	---
HP:	HP 556	HP 557	HP 558	HP 559	---	---	---	---
FG SURGICAL:	FGOS 556	FGOS 557	---	---	---	---	---	---
RA SURGICAL:	RAOS 556	RAOS 557	---	---	---	---	---	---

Straight Fissure Dome Crosscut

	0.9	1.0	1.2
Order #:	FG 1556	FG 1557	FG 1558
FGSS:	---	---	---
RA:	---	RA 1557	---
HP:	HP 1556	HP 1557	HP 1558
FG SURGICAL:	---	FGOS 1557	FGOS 1558

Inverted Cone

	0.6	0.8	1.0	1.2	1.4	1.6	1.8
Order #:	FG 33 1/2	FG 34	FG 35	FG 36	FG 37	FG 38	FG 39
FGSS:	FGSS 33 1/2	FGSS 34	FGSS 35	---	FGSS 37	---	---
RA:	RA 33 1/2	RA 34	RA 35	RA 36	RA 37	RA 38	RA 39
HP:	---	HP 34	HP 35	HP 36	HP 37	---	HP 39
FG SURGICAL:	---	---	---	---	---	---	---

Straight Fissure Dome

	0.9	1.0	1.2
Order #:	FG 1156	FG 1157	FG 1158
FGSS:	FGSS 1156	FGSS 1157	FGSS 1158
RA:	---	---	---
HP:	---	HP 1157	HP 1158
FG SURGICAL:	---	---	FGOS 1158

End Cutting

	1.0
Order #:	FG 957
FGSS:	---
RA:	---
HP:	---

Taper Fissure Crosscut

	0.9	1.0	1.2	1.6	2.1	0.9	1.0	1.2	1.6	2.1
Order #:	FG 699	FG 700	FG 701	FG 702	FG 703	FG 699L	FG 700L	FG 701L	FG 702L	FG 703L
FGSS:	FGSS 699	---	FGSS 701	---	---	---	---	---	---	---
RA:	RA 699	RA 700	RA 701	RA 702	RA 703	---	---	---	---	---
HP:	HP 699	HP 700	HP 701	HP 702	HP 703	HP 699L	HP 700L	HP 701L	HP 702L	HP 703L
FG SURGICAL:	---	---	FGOS 701	---	---	---	---	---	---	---

Taper Fissure

	0.8	0.9	1.0	1.2	1.4	0.9	1.0	1.2
Order #:	FG 168	FG 169	FG 170	FG 171	FG 172	FG 169L	FG 170L	FG 171L
FGSS:	---	FGSS 169	FGSS 170	---	---	---	---	---
RA:	---	RA 169	RA 170	---	---	---	---	---
HP:	---	---	---	---	---	---	---	---
FG SURGICAL:	---	---	---	FGOS 171	---	---	---	---

Inlay Prep

	1.2
Order #:	FG 271
FGSS:	---
RA:	---
HP:	---

Taper Fissure Dome

	0.9	1.0	1.2	1.6	0.9	1.0	1.2
Order #:	FG 1169	FG 1170	FG 1171	FG 1172	FG 1169L	FG 1170L	FG 1171L
FGSS:	---	---	---	---	---	---	---
RA:	---	---	---	RA 1172	---	---	---
HP:	---	---	---	HP 1172	---	---	---

Taper Fissure Dome Crosscut

	1.0	1.2	1.6
Order #:	FG 1700	FG 1701	FG 1702
FGSS:	---	---	---
RA:	---	---	---
HP:	---	HP 1701	HP 1702

- \$0.99ea 3x100/pk
- \$1.09ea 2x100/pk
- \$1.18ea 1x100/pk
- \$1.50ea 1x10/pk

FG
Friction Grip
1.6 mm

FGSS
FG SHORT SHANK
1.6 mm

LA/RA
Right - Angle (Latch Type)
RA 2.35mm Shank

RASS/LASS
Latch Type Right Angle
Short Shank 2.35 mm

- \$1.35 100pk
- \$1.50 10pk

FGSU/FGOS
Friction Grip Surgical Length
1.6 mm

LASU/RASU
Latch Type Right Angle
Surgical Length
2.35 mm

- \$1.50 100pk
- \$1.95 10pk

HP
For Slow Speed/
Straight Handpiece
HP LONG 2.35mm

\$1.95

T-REX Multi-Use Carbide Burs \$2.39 ea.

(in a pack of 10)

- Designed for rapid preparation and tooth reduction
- Cuts faster than crosscut, and smoother than straight bladed burs.
- Does not grab, catch, stall or break in hard materials. (amalgam, composite & semi/non-precious castings)

Most Popular T-REX
1958

Round (Ball)					Inverted Cone					Pear					Long Pear							
Order#	1902	1904	1906	1906os	1908	Order#	2034	2035	2037	Order#	1929	1930ss	1930	1931ss	1931	1932	Order#	1945	1946	Order#	2157	2158
Dia	1	1.4	1.8	1.8	2.3	Dia	0.8	1	1.4	Dia	0.6	0.6	0.8	1	1	1.2	Dia	0.9	1.2	Dia	1	1.2
L1	1	1.4	1.8	1.8	2.3	L1	0.8	1	1.4	L1	1.6	1.6	1.6	1.6	1.6	1.6	L1	2.7	3.7	L1	3.7	3.7
L2	19	19	25	19	19	L2	19	19	19	L2	19	16	19	16	19	19	L2	19	19	L2	19	19

As low as:
\$1.89ea
100 PACK

\$2.39ea
Individually
packed in a 10 pk

Flat-End Fissure					Round-End Fissure					Tapered Flat End					Tapered Dome End Criss-Cross Cut							
Order#	2056	2057ss	2057	2057os	2058	Order#	1956	1957	1958ss	1958	1958L	Order#	2069	2070	2071	2072	1969	Order#	1970	1971	2170	2171
Dia	0.9	1	1	1	1.2	Dia	0.9	1	1	1.2	1.2	Dia	1	1.2	1.2	1.6	0.9	Dia	1	1.2	1	1.2
L1	3.2	3.7	3.7	3.8	3.8	L1	3.2	3.7	3.7	3.7	5	L1	3.7	3.7	4.1	4.5	3.2	L1	3.7	3.7	3.7	3.7
L2	19	16	19	25	19	L2	19	19	16	19	21	L2	19	19	19	19	19	L2	19	19	19	19

**BUY 40 AND
GET 10 FREE**
50@**\$1.91ea**

SURGICAL LENGTH
\$1.99ea
\$1.99 ea. 100 / pk

X-REX Multi-Use Crown & Bridge Preparation Burs, The Ultimate Metal Cutter.

ROUND END TAPER	BU 856/012-8			BU 856/014-8			BU 856/016-8		
Ideal for Occlusal & Lingual Reductions	1.2	1.4	1.6	1.2	1.4	1.6	1.2	1.4	1.6
	8	8	8	8	8	8	8	8	8

FLAT END TAPER	BU 847/012-8			BU 847/014-8			BU 847/016-8			BU 847/018-8			
Ideal for Chamfer crown & bridge preparation	1.2	1.4	1.6	1.2	1.4	1.6	1.2	1.4	1.6	1.2	1.4	1.6	1.8
	8	8	8	8	8	8	8	8	8	8	8	8	8

Order# Diameter(mm) L1(Head)

Buy 40 Get 10 FREE (50@3.96ea)
Buy 80 Get 30 FREE (110@\$3.60ea)

\$4.95ea
In A Pack Of 10 (one solid piece shank)

Zirconia(Unsintered) Sprue Cutting Bur

Use for: Zirconia, CrCo Soft Metal and all other hard materials.

5 burs pkg \$36.50
Order# Z-28

CAD/CAM Carbide Cutting Bur
FG Shank: 1.60mm
Length: 28mm

Composite & Porcelain Finishing

Order No. Kit/06

249-016SXF	Flame
001-016XF	Round
465-016XF	Interdental
247-016XF	Flame
290-012XF	Torpedo
290-010XF	Torpedo
257-023XF	Football
167-012XF	Pointed Cone
173-017XF	Flat End Taper
174-013XF	Flat End Taper



Laminate Veneer

Order No. Kit/08

552-016M	Depth Marker
552-021M	Depth Marker
174-013XF	Flat End Taper
173-017M	Flat End Taper
247-016XF	Flame
290-010XF	Torpedo
290-010M	Torpedo
290-012M	Torpedo
290-012XF	Torpedo
112-014M	Flat End Cylinder



Pediatric Mini-Diamonds

Order No. Kit/12

001-006SF	Round
108-008SF	Flat End Cylinder
138-007SF	Round End Cylinder
161-007SF	Pointed Cone
164-007SF	Pointed Cone
197-013SHF	Round End Taper
197-013SHM	Round End Taper
246-007SF	Flame



Combo Porcelain Cutting Composite & Finishing Kit #18



Including 6 Porcelain Cutting and 12 Finishing Diamond Burs in a Gold Autoclavable Bur Block With Cover.

Kit #18

Kit Price:

\$89.00

Free when you buy 80 G-Burs



Crown Preparation

Order No. Kit/01

110-014M	Flat End Cylinder
166-017F	Pointed Cone
171-014C	Flat End Taper
173-017M	Flat End Taper
173-017C	Flat End Taper
174-013XF	Flat End Taper
290-010M	Torpedo
290-012M	Torpedo

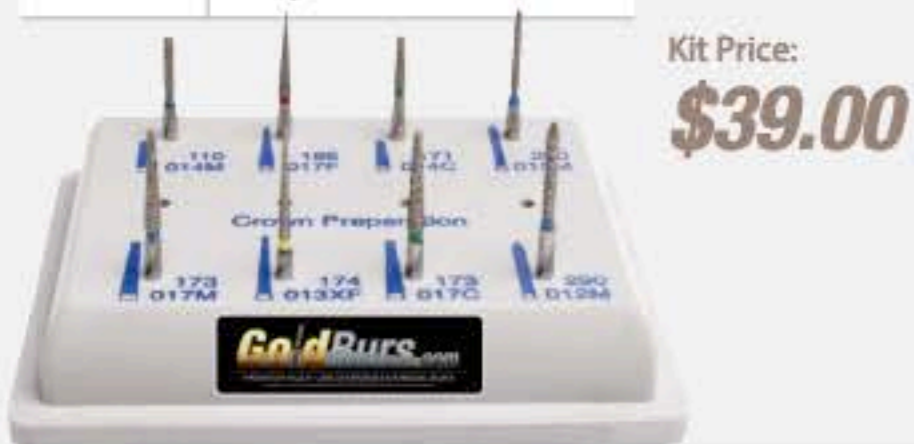

Cavity Preparation

Order No. Kit/04

238-014M	Pear
032-012M	Diablo
108-011M	Flat End Cylinder
108-011C	Flat End Cylinder
109-016M	Flat End Cylinder
001-010M	Round
002-017M	Round with Collar
010-016M	Inverted Cone



Helix

Order No. Kit/14

NEW!

Zirconia Cutter
The **Spiral**
Sharper & Faster

Excellent Crown-prep, Zirconia, Metal and Porcelain Cutting, all with the same Bur!

\$4.99 ea.
(in a pack of 10)

H197-020XC
H198-014XC
H198-016XC
H199-018XC
H199-016XC
H257-023XC

Kit Price:

\$59.00



Autoclavable Bur Holders

FREE with qualifying Order*

FG Burs
72 Holes

\$12.00ea



FG Burs
12 Holes



Bur Block 20 Holes
14 FG/6 RA



Plastic cover is not autoclavable

Multi-Use High Quality Autoclavable Impregnated Diamond Rubber Polishers

Polishine®

3+1 FREE

Universal Amalgam Polishing Multi-Use Kit

ORDER # KIT PLU Price: **\$39.00**



Autoclavable

Composite Polishing Multi-Use Kit

ORDER # KIT PLC Price: **\$49.00**



Autoclavable

Lithium E-Max Disilicate Multi-Use Kit

ORDER # KIT PLL Price: **\$49.00**



Autoclavable

Zirconia Polishing Multi-Use Kit

ORDER # KIT PLZ Price: **\$49.00**



Autoclavable

Daisy Lithium Disilicat kit

Order# DLP Price: **\$59.00**

Best for Silicate porcelain polishing.

6 pcs in 2 burr blocks

Step 1



Step 2



Daisy Composite kit

Order# DCP Price: **\$49.00**

Hi shine for all composites.

6 pcs in 2 burr blocks



Daisy Zirconia Kit

Order# DZP Price: **\$59.00**

Full contour Zirconia restorations

Price: **\$59.00**
6 pcs in 2 burr blocks



Daisy

KIT# BUD Price: **\$49.00**

Designed top-notch performance on occlusal surfaces

6 pcs in 2 burr blocks



iBrite[®] Automix Gel-Type Tooth Whitening System

- Instant Activation
- No refrigeration required
- Gingival protection guarantees patient comfort

The iBrite[®] 30% HP dual-barrel professional whitening gel produces amazing results and requires no refrigeration. The dual-barrel system means no troublesome syringe-to-syringe mixing, while the unique proprietary formulation features active calcium ions that promote remineralization. The mixed gel has a balanced pH value, and includes potassium nitrate and fluoride to further eliminate sensitivity. The kit comes with all the items needed to perform a complete whitening treatment.



5-Patient Kit

Single-Patient Kit



IB-801 Single patient kit **\$39.00**

IB-803 5-patient kit **\$139.00**

IB-814 Gingival barrier refill kit, 4 x 1.2ml syringes **\$30.00**

Single-Patient Kit Contents		5-Patient Kit Contents	
1 - 3.5ml 30% HP syringe	3 - Dappen dishes	2 - 6.4ml 30% HP syringes	5 - Mini brushes
1 - 1.2ml Gingival barrier syringe	1 - Shade guide	5 - Gingival barrier syringes	5 - Dappen dishes
3 - Dispensing tips	1 - Vitamin E Swab	5 - Lip protection cream	1 - Instructions
1 - Face cover	1 - Mini brush	5 - Pre-bent needle tips	5 - Photo-blocking tips
1 - Cheek retractor	1 - ProAngle [®] DPA	5 - Face covers	1 - Shade guide
1 - Instructions		2 - Cheek retractors	1 - ProAngle [®] DPA

BUY 3 GET 1 FREE
Manufacturer Special

C&B Prompt[™] Temporary Crown & Bridge Material

- Exceptional strength and abrasion resistance
- Defined elastic phase for easy removal
- True color stable Vita shades with natural fluorescence
- Minimal heat (= body temp.) during polymerization
- Easy to polish to a long lasting luster

BUY 3 GET 1 FREE
Manufacturer Special



PD-123 Refill, shade: A1
PD-124 Refill, shade: A2
PD-125 Refill, shade: A3

\$99.00



PD-T1610BL-25	4:1/10:1 mixing tip, cobalt, 25/PK	\$22.75
MP-04	S-Dispenser II 50 ml 4:1/10:1	\$125.00
PD-177	Dispensing Gun 10:1 Type 50	\$45.00
PD-126	Intro kit: 1- 50 ml cartridge, 10 - mixers, 1 - 10:1 Dispenser	\$224.00

ProAngle[®] Disposable Propphy Angle ProPaste[™] Propphy Paste

\$24.95



Firm Cup Soft Cup

- Patented 2nd generation gear design
- Runs smoothly without over-heating
- 100% latex-free cups
- Non-splatter
- Fluoride-releasing

2005
The **BPB 100**



247-144	Soft green cup, 144/box	\$44.50 As low as - 0.22ea
248-144	Firm white cup, 144/box	
247-500	Soft green cup, 500/box	\$139.95 As low as - 0.22ea
248-500	Firm white cup, 500/box	

260-200	Coarse Mint
262-200	Coarse Cherry
264-200	Coarse Assorted
266-200	Fine Bubble Gum
270-200	Coarse Grape
261-200	Medium Mint
263-200	Medium Cherry
265-200	Medium Assorted
268-200	Medium Strawberry

30 Gold Burs FREE (\$120 Value) with the purchase of any Beyes handpiece

AirLight[®]

M800 PLUS

Generator + Direct LED High Speed Handpiece

This new AirLight PLUS is one of the most powerful air-driven handpieces today!

- Direct LED
- 25W of Torque
- Triple Spray
- Handles Up to 60 PSI of Air Pressure
- Built-In Micro-Generator
- Ceramic Ball Bearings
- Titanium Body

Mix & Match
3+1 FREE

1 Year Warranty!

Connection	Mini Head
4 Hole Star [®]	HP3008P
Kavo [®]	HP3054P
NSK [®]	HP3036P
W&H [®]	HP3043P
Beyes [®] QD	HP3022P
Beyes [®] PD	HP3015P
	HP6018P



Direct LED

Without Fiber Optic

Built-in Generator

Price:
\$439/ea

Internal spray, contra-angle and straight slow speed handpiece

Specifications:

1. Ratio: E-type Low Speed Handpiece 1:1 Ratio, with Internal water Cooling System
2. Air Pressure: 245-392Kpa (2.5-4.0 kgf/cm²)
3. Water Pressure: 200Kpa (2kg)
4. Rotation Speed: 14,000-20,000 rpm
5. Chuck Type: Press button
6. Bur Applicable: Ø2.334-2.355mm (CA BUR CONTRA ANGLE & HP BUR STRAIGHT CONE)
7. Noise: ≤60dB

best value!

3 piece set for \$359
Model EX-203 internal
\$40 Credit in G-Burs



Contra Angle Handpiece \$139

Straight Handpiece \$139

4 Holes Handpiece \$139

The Future Is: **RODIN[™]**
3D Resin

3D Printing Materials

- Use For:
- Modeling
 - Surgical Guides
 - Investment Molds
 - Occlusal Splints



Introductory

20%-25%
OFF

On GoldBurs.com

Mounted discs available with riveted or screwed mandrel:

Diamond Discs - Mounted dental discs

\$16ea Buy 5 Get 1 FREE

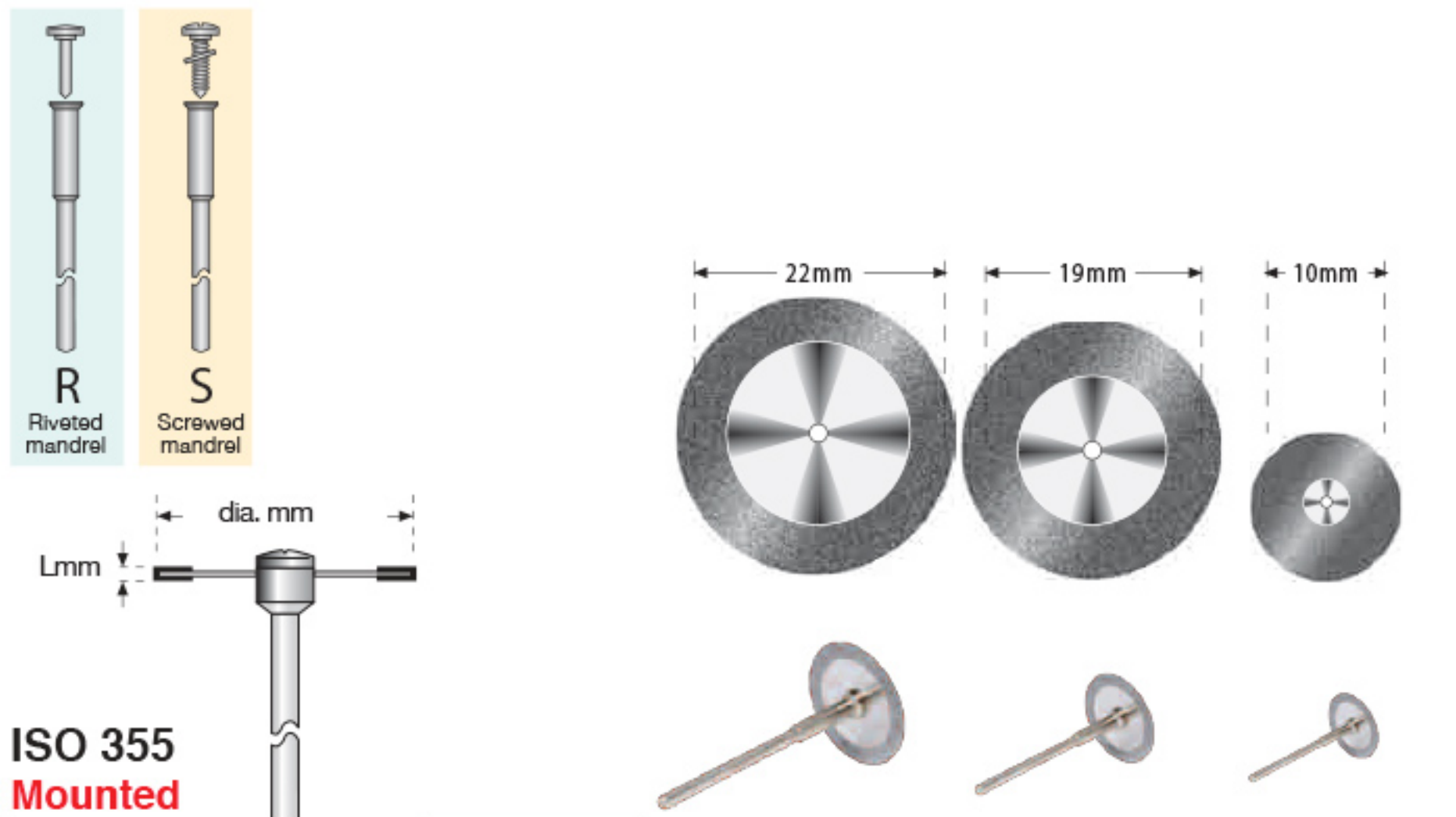

ISO 355 Mounted

Super Flex		Thickness mm		
Riveted mandrel	● XF Order No.	0.17	R04/355 504 220	R04/355 504 190
Riveted mandrel	● F Order No.	0.25	R04/355 514 220	R04/355 514 190

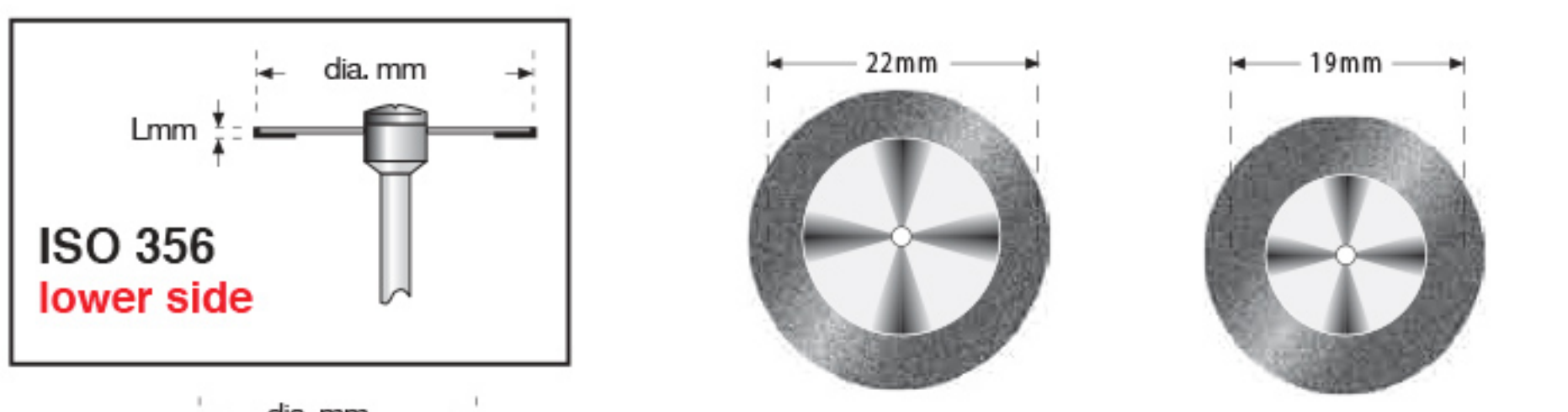

ISO 356 lower side

ISO 357 Mounted

Super Flex		Thickness mm		
Riveted mandrel	● XF Order No.	0.12	R04/357 504 220	R04/357 504 190
Riveted mandrel	● F Order No.	0.15	R04/357 514 220	R04/357 514 190
Screwed mandrel	● XF Order No.	0.12	S04/357 504 220	S04/357 504 190
Screwed mandrel	● F Order No.	0.15	S04/357 514 220	S04/357 514 190

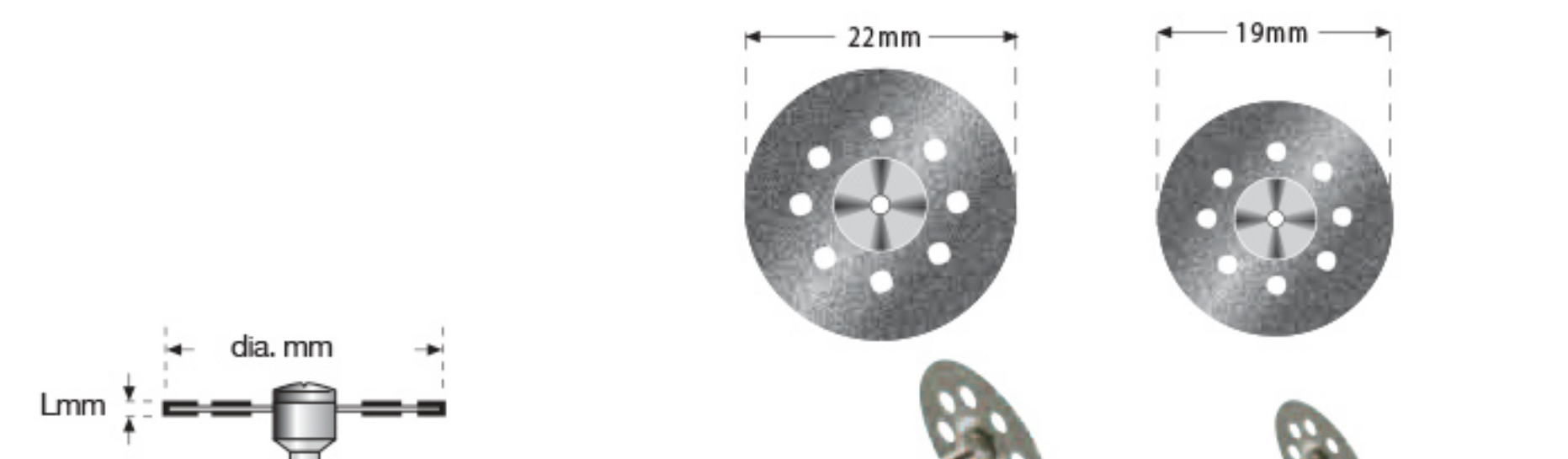

ISO 350 Mounted

Flex		Thickness mm		
Riveted mandrel	● F Order No.	0.30	R04/350 514 220	R04/350 514 190
Riveted mandrel	● M Order No.	0.40	R04/350 524 220	R04/350 524 190

ISO 335 Mounted

Semi Flex		Thickness mm		
Riveted mandrel	● F Order No.	0.45	R04/335 514 220	R04/335 514 190
Riveted mandrel	● M Order No.	0.55	R04/335 524 220	R04/335 524 190
Riveted mandrel	● C Order No.	0.60	R04/335 534 220	R04/335 534 190

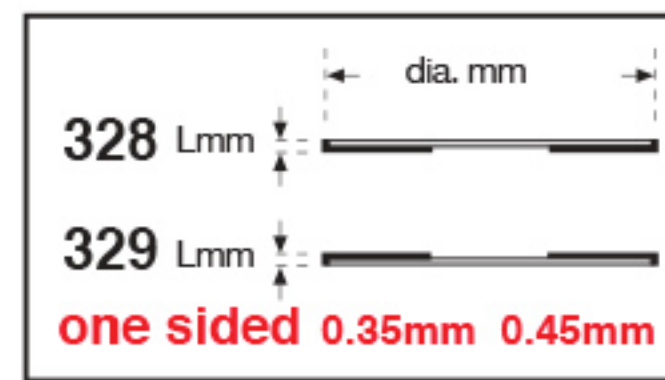

ISO 328 Mounted

Super Flex		Thickness mm		
Riveted mandrel	● XF Order No.	0.17	R04/358 504 220	R04/358 504 190
Screwed mandrel	● XF Order No.	0.17	S04/358 504 220	S04/358 504 190
Screwed mandrel	● XF Order No.	0.12	S04/359 504 220	S04/359 504 190

ISO 345 Mounted

Flex		Thickness mm		
Riveted mandrel	● F Order No.	0.30	R04/345 514 220	R04/345 514 190
Riveted mandrel	● M Order No.	0.40	R04/345 524 220	R04/345 524 190
Screwed mandrel	● UF Order No.	0.16	S04/345 494 220	
Screwed mandrel	● F Order No.	0.20	S04/346 514 220	S04/346 514 190
Screwed mandrel	● M Order No.	0.25	S04/346 524 220	S04/346 524 190

ISO 327 Mounted

Semi Flex		Thickness mm		
Riveted mandrel	● F Order No.	0.45	R04/327 514 220	R04/327 514 190
Riveted mandrel	● M Order No.	0.55	R04/327 524 220	R04/327 524 190
Screwed mandrel	● C Order No.	0.60	S04/327 534 220	
Screwed mandrel	● XC Order No.	0.65	S04/327 544 220	

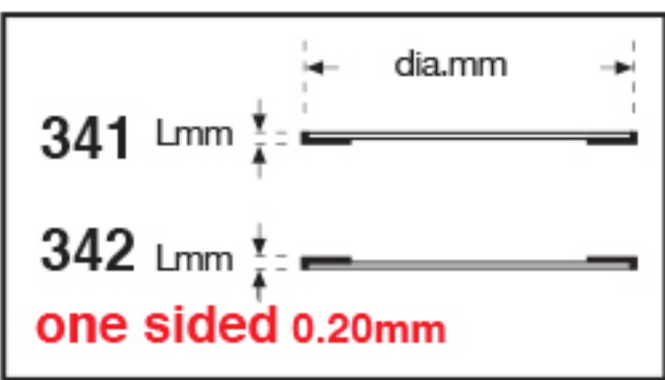

ISO 340 Mounted

Flex		Thickness mm		
Riveted mandrel	● F Order No.	0.30	R04/340 514 300	R04/340 514 220
Screwed mandrel	● F Order No.	0.30	S04/340 514 300	S04/340 514 220

Large Discs Model Preparation

Available Sizes:

45 mm	75 mm
70 mm	80 mm

\$28.00 **\$39.00**

ISO 377

Flex		Thickness mm		
● F Order No.	0.30	377 514 220		
● XF Order No.	0.25	377 504 220		

ISO 379PS

Flex		Thickness mm		
● F Order No.	0.30	379PS 514 220		
● XF Order No.	0.25	379PS 504 220		

ISO 390

Flex		Thickness mm		
● F Order No.	0.30	390 514 220		
● XF Order No.	0.25	390 504 220		

ISO 350PS

Flex		Thickness mm		
● F Order No.	0.30	350PS 514 220		
● XF Order No.	0.25	350PS 504 220		

Model Preparation

10 dia. #111-T10 **\$199.90**

12 dia. #111-T12 **\$249.00**

Diamond Coated Trimmer Wheels
With embedded diamonds, it cuts faster, smoother & quieter than regular stones or abrasives wheels without downtime. It will not bend or rust like aluminum. Self-cleaning and last longer than regular trimming wheels.

HP DIAMONDS

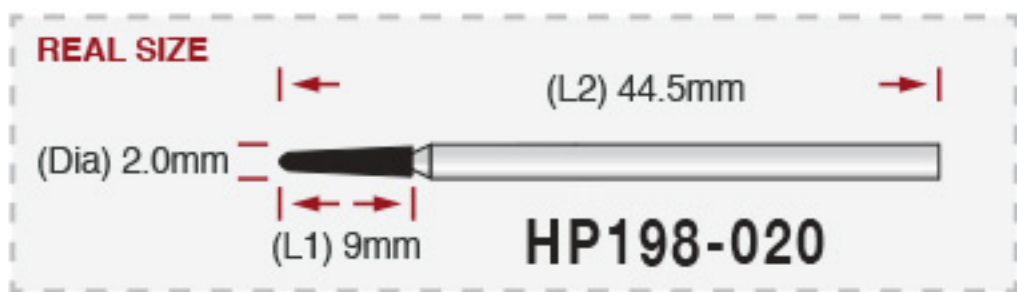

Up to 1.9 mm \$5.00 ea
 2.1 mm to 3.9 mm \$6.00 ea
 4.0 mm to 5.9 mm \$8.00 ea
 6.0 to 8.0 mm \$12.00 ea

BUY 5 GET 1 FREE

Round Ball 001 / 801

Inverted Cone 010 / 805

Flat End Cylinder

Flame

	HP001-009	HP001-013	HP001-017	HP001-024	HP001-033	HP001-037	HP010-027	HP010-033	HP010-045	HP010-045	HP225-023	HP225-048L	HP112-040L	HP111-033	HP249-018	HP250-027
L1	0.9	1.3	1.7	2.4	3.3	3.7	2.2	2.8	2.5	2.5	6.0	10.0	10.0	8.0	8.0	11.0
L2	44.5	44.5	44.5	44.5	44.5	44.5	44.5	44.5	42	42	44.5	53	53	44.5	44.5	45

Flat End Taper 172 / 847

Round End Taper 198 / 856

Football 257 / 368

Bud 260 / 875

Pointed Cone 167L / 859L

	HP172-033	HP172-050	HP173-016L	HP198-020	HP199-020	HP198-015L	HP199-020L	HP257-030	HP257-040	HP260-065	HP263-060	HP266-048	HP266-065	HP164-040	HP166-024	HP167-012L
L1	9.2	9.2	10.0	9.0	10.0	8.0	10.0	5.0	9.0	11.0	13.0	13.0	20.0	6.5	10	11.0
L2	48.5	46.0	53	44.5	44.5	53	53	44.5	41	44.5	50	44.5	57.0	44.5	44.5	53

Diamond Grinders (Coarse) \$16ea

Diamond Grinders cut cool with low surface temperature; is enormously aggressive in grinding efficiencies; does not tarnish the surface; is self sharpening; and makes a very soft and smooth cut. These are used for ceramic, porcelain-bonding alloys, CoCr, titanium and gold. Max Speed: 5,000rpm ~ 8,000rpm

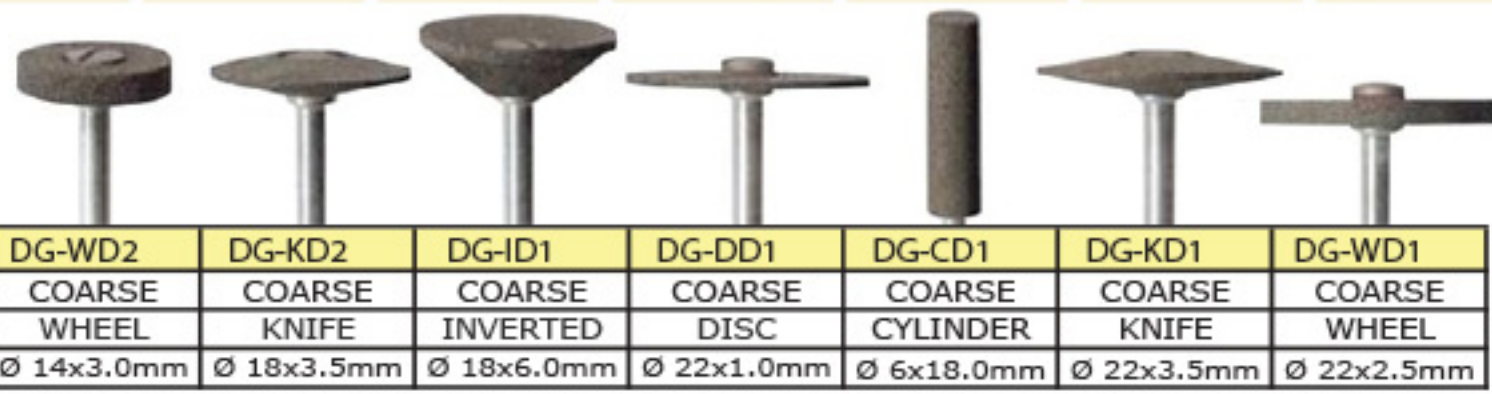

Titanium Nitrite Coated Carbide Burs each \$10



Diamond Rubber Polishers

Diamond impregnated rubber wheel for super LUSTER for Porcelains and Metals

Rubber Diamond Impregnated

Excellent for cutting, abrading, removing scratches and smoothen zirconia, porcelain, metals and hard materials.



RD-W1	RD-W2	RD-W3	RD-C4	RD-P5	RD-T6	RD-W7
COARSE	MEDIUM	X-FINE	MEDIUM	MEDIUM	MEDIUM	MEDIUM
WHEEL	WHEEL	WHEEL	CYLINDER	POINT	TAPER	WHEEL
12,000RPM	12,000RPM	12,000RPM	15,000RPM	15,000RPM	15,000RPM	10,000RPM
26 X 2MM	26 X 2MM	26 X 3MM	Ø 3x7mm	Ø 4x12mm	Ø 4x12mm	Ø 12x2mm

Diamond Impregnated Green Stone for Zirconia

CD-B20	CD-T30	CD-W10	CD-W40	CD-B50	CD-I70	CD-W60
MEDIUM	MEDIUM	MEDIUM	MEDIUM	MEDIUM	MEDIUM	MEDIUM
BARREL	TAPER	WHEEL	WHEEL	BARREL	INV. CONE	WHEEL
12,000RPM	15,000RPM	10,000 RPM	10,000RPM	12,000RPM	10,000RPM	10,000RPM
5 X 12MM	4 X 12MM	22 X 2MM	22 X 2MM	7 X 13MM	13 X 7MM	22 X 4MM

ACRYLIC CUTTERS



\$16 ea. BUY 5 GET 1 FREE

Non Clogging Acrylic Cutter

Bulk Cross Cutters

Plain Cross Cut

Medium Spiral

Extra Fine

Fine Cutters

Lance 509001 509101 509801 5001201 5001202 5001203 5001204 5001205 5001206 100801 101001 203001 203101 700801 702102

Medium Criss-Cross Cutters

Coarse Criss-Cross Cutters

302801 302901 303001 303002 303101 305002 302001 302302 406001 406302 406602 406801 406901 407001 407101 407301 407401 407402

ZIRCONIA CERAMIC CUTTERS

(HP SHANK 3/32"/2.35mm)

For trimming non-metallic material like acrylic resin, plaster, etc.
ZIRCONIA SHANK \$29.00 METAL SHANK \$23.50

EXTREMELY LONG LIFE 10 X TRADITIONAL CUTTERS

Antibacterial • Non clogging • Resistance of acid, alkali and heat • Improvement of customers' feel

6300305 XC 4.0mm	6300401 C 6.0mm	6300501 M 6.0mm	6300601 F 6.0mm	6300315 XC 2.3mm	6300304 XC 3.0mm	6310518 M 5.0mm	6400503 M 6.0mm	6300207 XXC 2.3mm	610485 C 6.0mm Lgh 51mm
6400202 XXC 6.0mm	64002602 F 6.0mm	6400802 XXF 6.0mm	6410201 XXC 6.0mm	6410301 XC 6.0mm	6410401 C 6.0mm	6440501 M 6.0mm	6420601 F 6.0mm	6400701 XF 6.0mm	6400801 XXF 6.0mm

iBrite® Automix Gel-Type Tooth Whitening System

- Instant Activation
- No refrigeration required
- Gingival protection guarantees patient comfort
- Desensitizing additives minimize sensitivity during and after procedures



5-Patient Kit

Single-Patient Kit

**BUY 4
GET 1 FREE**
Manufacturer special

The iBrite® 30% HP dual-barrel professional whitening gel produces amazing results and requires no refrigeration. The dual-barrel system means no troublesome syringe-to-syringe mixing, while the unique proprietary formulation features active calcium ions that promote remineralization. The mixed gel has a balanced pH value, and includes potassium nitrate and fluoride to further eliminate sensitivity. The kit comes with all the items needed to perform a complete whitening treatment.

Single-Patient Kit Contents		5-Patient Kit Contents	
1 - 3.5ml 30% HP syringe	3 - Dappen dishes	2 - 6.4ml 30% HP syringes	5 - Mini brushes
1 - 1.2ml Gingival barrier syringe	1 - Shade guide	5 - Gingival barrier syringes	5 - Dappen dishes
3 - Dispensing tips	1 - Vitamin E Swab	5 - Lip protection cream	1 - Instructions
1 - Face cover	1 - Mini brush	5 - Pre-bent needle tips	5 - Photo-blocking tips
1 - Cheek retractor	1 - ProAngle® DPA	5 - Face covers	1 - Shade guide
1 - Instructions		2 - Cheek retractors	1 - ProAngle® DPA

IB-801
Single patient kit
\$39.00

IB-803
5-patient kit
\$167.99

IB-814 Gingival barrier
refill kit, 4x1.3ml syringes
\$35.98

iBrite® Gel-Type Take-Home Kit

- No need for custom fabricated tooth trays
- Prolonged activation time
- Guaranteed results in 2 weeks or less
- Dual-barrel gel formulated to reduce hypersensitivity and strengthen teeth enamel



12%HP Dual-Barrel Kit

Take-home Hydrogen Peroxide-based tooth whitening system that features the innovative iBrite® tray silicone-based self-impression tooth tray. Available in 3 hydrogen peroxide concentrations for different patient needs: 6%, 9% and 12%. Undiluted purified H₂O₂ formula acts nearly 4 times faster than traditional carbamide peroxide whitening gels. Dramatic whitening results can be achieved in 1 ~ 2 weeks if used as instructed. iBrite® kit can be used as a standalone take-home tooth whitening product, or to enforce and maintain chair-side whitening results.

Kit Contents

- 6 - 1.2ml H₂O₂ gel syringes
- 1 - iBrite® Tray w/ silicone bite impression
- 6 - Dispensing tips
- 1 - User instructions

		SALE	MSRP
IB-806H	iBrite® 6% HP whitening kit	\$36.40	\$79.00
IB-809H	iBrite® 9% HP whitening kit	\$36.40	\$79.00
IB-812H	iBrite® 12% HP whitening kit	\$36.40	\$79.00

ProAngle® Disposable Propy Angle

MOST POPULAR PROPHY

- Patented 2nd generation gear design
- Runs smoothly without over-heating
- 100% latex-free cups

**BUY 4
GET 1 FREE**
Manufacturer special

Patented prophy angle that employs the same design as ProAngle® Plus to ensure each prophy procedure only requires one angle to finish.

ProAngle® utilizes the same beveled gear design as ProAngle® Plus for assured quality and performance.



Firm Cup

Soft Cup

\$59.25

\$189.99

247-144	Soft green cup, 144/box
248-144	Firm white cup, 144/box

247-500	Soft green cup, 500/box
248-500	Firm white cup, 500/box

As low as - 0.32ea

As low as - 0.30ea

BUY 3 GET 1 FREE

NeoTip™ Air/Water Syringe Tip

- Inner tube does not move under pressure
- Designed for snug locking fit
- Beveled edge improves patient comfort
- Interchangeable with most tips with no conversion
- Quad air-core design with separate air and water channels

105-250AST	250 per pack, assorted colors	\$49.97
105-1500AST	1500 per pack, assorted colors	\$271.89



Air Channels

Water Channel

KleanTip™ Air/Water Syringe Tip

- Consistent and instant dry air with no moisture contamination
- Rounded non-scratch ends for maximum patient comfort
- Clear and smooth disposable tip provides a clear view
- Rigid enough for retraction
- Latex-free

ST-250	Clear, Standard 76mm, 250 per pack	\$53.55
ST-1500	Clear, Standard 76mm, 1500 per pack	\$299.99

BUY 3 GET 1 FREE

ProPaste™ Propy Paste

- Non-splatter
- Fluoride-releasing

Prophy paste with a non-splatter formula! Conveniently packaged into 2gm unit-doses with an easy to dispense box. Exceptional polishing and stain-removal ability, with fluoride release. Great taste and easy rinse-off.



Each order comes with 200 unit-doses of paste, 2 autoclavable prophy rings and a ProAngle® sample

\$31.82

\$31.82

260200	Coarse Mint
262200	Coarse Cherry
264200	Coarse Assorted
266200	Fine Bubble Gum
270200	Coarse Grape

261200	Medium Mint
263200	Medium Cherry
265200	Medium Assorted
268200	Medium Strawberry

BUY 3 GET 1 FREE

TruTip™ Colors Air/Water Syringe Tip

- Colored plastic with stainless steel core
- Interchangeable with most tips with no conversion
- Designed for snug locking fit
- Rounded edge improves patient comfort

103-150W	White, 150 per pack	\$33.77
103-150AST	Assorted colors, 150 per pack	
103-1600W	White, 1600 per pack	\$299.98
103-1600AST	Assorted colors, 1600 per pack	



Unique Air-Channel Design

\$60 discount

use code:
PD-\$60
min order \$500

C&B Prompt™ Temporary Crown & Bridge Material

- Biocompatible
- Easy handling and polishing
- Improved precision of application
- Lifetime restoration with natural translucency
- Excellent resistance to fracture



PD120	Shade: A1/B1	\$89.00	PD211-50	Blue mixing tips refill, 50/bag	\$49.87
PD121	Shade: A2	\$89.00	PD211-25	Blue mixing tips refill, 25/bag	\$25.85
PD122	Shade: A3	\$89.00	PD-115	Dispensing gun, 1 per box	\$79.96

C&B Prompt™ Temporary Crown & Bridge Material

- Exceptional strength and abrasion resistance
- Defined elastic phase for easy removal
- True color stable Vita shades with natural fluorescence
- Minimal heat (= body temp.) during polymerization
- Easy to polish to a long lasting luster



BUY 3 GET 1 FREE
Manufacturer special

PD123 Refill, shade: A1
PD124 Refill, shade: A2
PD125 Refill, shade: A3
Sale: \$99.00

PD-T1610BL-25	4:1/10:1 mixing tip, cobalt, 25/PK	\$26.13
MP04	S-Dispenser II 50 ml 4:1/10:1	\$133.69
PD177	Dispensing Gun 10:1 Type 50	\$79.96
PD126	Intro kit: 1- 50 ml cartridge, 10 - mixers, 1 - 10:1 Dispenser	\$245.00

PacBond™ Adhesive

A 5th generation single-component light-cure adhesive system designed for multi bonding applications. Works well in both moist and dry environment. This adhesive is suitable for bonding composites to dentin, enamel, treated amalgam, metal and ceramic surfaces.



R3007	1 x 7ml bottle	\$59.00
-------	----------------	---------

PacSeal™ Pit & Fissure Sealant

- Wet-bonding resin technology
- No drying or bonding agents required
- Seals against microleakage
- Margin-free
- Quick and easy syringe delivery



PD-138	4 x 1.2 ml syringes, natural shade, 20 x brush tips	\$43.00
--------	---	---------

\$60 discount use code: **PD-\$60** min order \$500

OptiFlow™ II Flowable Composite, LC

4-pack: 4x 1.5 gm Syringes 20x Blue Flo-Tips

8201	A1	\$36.22
8202	A2	\$36.22
8203	A3	\$36.22
8204	A3.5	\$36.22
8206	B1	\$36.22
8209	B3	\$36.22
8212	C2	\$36.22
8215	D2	\$36.22

Resin based, low viscosity flowable light cure composite. Natural translucency, high radiopacity and great controlled flowability. Also available with high viscosity.



PacEtch™ Etching Gel

- Can be used for etching enamel and glass ionomer cement
- Included pre-bent needles offer precise placement of gel



135	4 x 1.2 ml syringes, 8 x pre-bent needle tips	\$11.86
135-E	Econo pack: 36 x 1.2 ml syringes, 72 x needle tips	\$91.73
135-C	Clinic pack: 144 x 1.2 ml syringes, 288 x needle tips	\$299.99

S-Dispenser II Impression Dispensing Gun

- Medical look-and-feel
- Self explaining handling, outstanding ergonomics
- Fatigue-free usage and a precise work, even with high viscosity materials
- The possibility to choose design colors and place logo



MP01	Dispenser 50 ml 1:1/2:1	\$124.21
MP04	Dispenser 50 ml 4:1/10:1	\$133.69



PD-115	1 x 1:1 & 2:1 HP impression gun	\$79.96
PD-177P	1 x 10:1 & 4:1 impression gun	

HP Impression Gun

High performance impression gun, fits all standard size cartridges.

Elements™ Bite Registration

- Fast procedure time
- Generous work time
- Excellent handling and accuracy
- Included ribbon tips ensure easy dispensing



PD187	Fast set regular pack, mint flavor	\$26.95	PD187-4	Fast set bulk pack, mint flavor, 4 x 50ml cartridges	\$39.99
PD186	Fast set regular pack		PD186-4	Fast set bulk pack, 4 x 50ml cartridges	
PD190	Regular set regular pack		PD190-4	Regular set bulk pack, 4 x 50ml cartridges	
PD185	Super fast set regular pack		PD185-4	Super fast set bulk pack, 4 x 50ml cartridges	

Orders over \$400 get 30 to 50 FREE Gold Plated Diamond Burs (\$120-\$200 value)



2022 Specials

AirLight® M800 Plus LED High Speed Handpiece

- 23W of Torque
- 410,000 RPM
- Ceramic Ball Bearings
- Handles up to 60 PSI of air pressure
- Titanium Body
- 1 Year Warranty

Backend	Code
4 Hole	HP3008P
Beyes®	HP6018P
W&H®	HP3022P
Star®	HP3054P
NSK®	HP3043P
KAVO®	HP3036P

Direct LED Without Fiber Optics!
Just Brilliantly Bright Illumination!



Price: \$439/ea
-\$120 credit in Gold Burs
Price with credit: \$319/ea

BUY 3 GET 1 FREE!



Built-in Generator

AirLight® M800 Surgical 45 LED High Speed Handpiece

- 22W of Torque
- 45 Degree Angled Head
- 410,000 RPM
- Rear Air Exhaust
- Direct LED
- Stream Water
- 1 Year Warranty

Backend	Code
4 Hole	HP3048
KAVO®	HP3037
NSK®	HP3044
Beyes®PD	HP6038

Price: \$498/ea
-\$120 credit in Gold Burs
Price with credit: \$378/ea

Triple Spray
Direct-LED

Built-in Generator



BUY 3 GET 1 FREE!

EZ-Swivel® Couplers

Beyes® PD



HP6008 4 Hole
Reg. \$144/ea **Net: \$96/ea**

NSK® Type



HP3046 4 Hole, Fiber-optic
HP2069 6 Hole, Fiber-optic
Reg. \$240/ea **Net: \$160/ea**

Kavo® Type



HP2063 4 Hole, Non-optic
HP2064 6 Hole, Fiber-optic
Reg. \$240/ea **Net: \$180/ea**

Maxso® E800

Electric Micromotor System Package

- **Powerful:** 5.0 Ncm of torque
- **Steady Performance:**
Speed of rotations is controlled between 2,000 and 40,000min-1
- **Smooth Operation:**
Torque ripple and heat reduction technology eliminates vibrations
- **Convenient & Durable:**
Smooth and easy to clean surface with autoclavable brushless motor
- **3 Programmable Memory Settings:**
Easily switch between speed presets for more efficient workflow
- **New Touch Screen Interface:**
Easily and quickly navigate through menu settings on a color LCD display panel
- **Warranty:** 25 months



Code: (MT8001KIT1)

E800P+One X99L Attachment
Reg. \$2,350 **-\$200 credit in Gold Burs**
= \$2150/ea



Code: (MT8001KIT2)

E800P+Two X99L Attachment
Reg. \$2,998 **-\$200 credit in Gold Burs**
= \$2798/ea

Maxso® M200E

Non-Optic High Speed Handpiece

- 19W of Torque
- 400,000 RPM
- Single Spray
- Push Button
- Low Turbine Noise
- No Swivel
- 6 Months Warranty

(HP2105) 4 Hole
Reg. \$125/ea

BUY 5 FOR \$500!



-\$120 credit in Gold Burs
Price with credit: \$380/ea

CareMaster®

Automatic Handpiece Maintenance System

- Maximize the lifespan of handpieces
- Economical, efficient and time-saving
- Filtered air used to rotate the handpieces
- Detachable door for easy cleaning
- Provides care for all brands of handpieces
- 1 Year Warranty



(HPL2010) 2 Turbines & 1 E-Type Attachment
Reg. \$1296/ea **-\$200 credit in Gold Burs** = \$1096/ea

(HPL2011) 1 Turbines & 2 E-Type Attachments
Reg. \$1396/ea **-\$200 credit in Gold Burs** = \$1196/ea

Maxso® Low Speed

E-Type Connection



1 Year Warranty Mix and Match

	Reg	Net
A. SL2026 1:1 Push Button (CA Burs)	\$168/ea	\$126/ea
B. SL2028 1:1 Latch Type (CA Burs)	\$132/ea	\$99/ea
C. SL2034 1:1 Screw-On	\$120/ea	\$90/ea
D. MT2010 Air Motor, 4 Hole, 20,000RPM	\$284/ea	\$213/ea
E. ST2010 1:1 Straight Nose Cone	\$108/ea	\$81/ea
F. SL1002 4:1 Nose Cone, For DPA	\$218/ea	\$163 ⁵⁰ /ea

Mix & Match any 3. Promotional goods must be of equal or lesser value than the lowest priced item purchased.

Orders over \$400 qualify for the \$120 credit in Gold Burs

BUY 3 GET 1 FREE!

Slimax-C Plus®

LED Curing Light System

- Built-In Digital Radiometer
- LED Display Panel
- Cordless, Portable Design
- Cures 850 Times Per Charge
- Up to 2000 mW/cm ± 10%
- Rechargeable Samsung Lithium-Ion Battery
- Solid Aluminum Body
- 1 Year Warranty

Color	Code
Silver	SM1003P-S
Blue	SM1003P-B
Pink	SM1003P-PI

-\$120 credit in Gold Burs
Price after credit: \$298/ea

BUY 2 GET 1 FREE!

Price: \$628/ea
Net price \$418.66/ea



Compatibility Chart				
Variable Taper Files Examples		Constant Taper Files Examples		
Standard NiTi	Heat Treated NiTi	Standard NiTi	Heat Treated NiTi	Heat Treated NiTi
PacTaper™ NiTi	PacTaper™ Conform™	PacFile™ NiTi	PacFile™ Conform™	One FILE™ G
ProTaper* Channel* EdgeTaper*	ProTaper Gold* EdgeTaper Platinum*	K3* ESX Endosequence* Vortex*	Twisted File* HyFlex CM* Vortex Blue*	WaveOne*Gold* EdgeOne Platinum*Files*

Pac-Taper™ NiTi™ Rotary Files

Comparable to ProTaper®

- Made of premium Super-Elastic USA made nickel-titanium
- Ideal for simple straight canals, calcified canals and removing gutta-percha
- Calibration rings for setting accurate working length

Variable Taper Comparable to ProTaper® Gold*
3 fluted file design
Calibration rings for setting accurate working length

Pac-Taper™ Conform™ Rotary Files

Comparable to ProTaper® Gold

- Made of proprietary treated USA nickel-titanium alloy

Can be pre-bent

- No rebound
- 490% more resistance against breakage caused by cyclical fatigue

Excellent canal tracking

MTA Disposable Carriers

0.80mm 0.99mm 1.60mm

Pac-Taper™ NiTi™ 6/pk \$39.50		Pac-Taper™ Conform™ 6/pk \$38.50		
Gold Handle		Silver Handle		
21mm 25mm 31mm		21mm 25mm 31mm		
SX	CX	TFC19CX (19mm)		
S1	C1	TFC21C1 TFC25C1 TFC31C1		
S2	C2	TFC21C2 TFC25C2 TFC31C2		
F1	A1	TFC21A1 TFC25A1 TFC31A1		
F2	A2	TFC21A2 TFC25A2 TFC31A2		
F3	A3	TFC21A3 TFC25A3 TFC31A3		
F4	A4	TFC21A4 TFC25A4 TFC31A4		
F5	A5	TFC21A5 TFC25A5 TFC31A5		
SX, S1, S2, F1, F2 & F3 (assorted)	CX, C1, C2, A1, A2 & A3 (assorted)	TFC21AS TFC25AS TFC31AS		
		TNT19CX (19mm)		
		TNT21C1 TNT25C1 TNT31C1		
		TNT21C2 TNT25C2 TNT31C2		
		TNT21A1 TNT25A1 TNT31A1		
		TNT21A2 TNT25A2 TNT31A2		
		TNT21A3 TNT25A3 TNT31A3		
		TNT21A4 TNT25A4 TNT31A4		
		TNT21A5 TNT25A5 TNT31A5		
		TNT21AS TNT25AS TNT31AS		

- Reduce waste of MTA material
- Save time by eliminating instrument cleaning
- Deliver MTA directly to the apex of the root canal
- Use for a broad range of clinical MTA application
- Bendable cannula

SKU	Variants	\$55.95
MTA-01	Type: 10 X 0.80 mm	
MTA-02	Type: 10 X 0.99 mm	
MTA-03	Type: 10 X 1.60 mm	
MTA-04	Type: 4 X 0.80 mm, 3 X 0.99 mm, 3 X 1.60 mm	

EASY TO PLACE

Rubber stops and calibration rings facilitate proper insertion length

EASY TO USE

Easy to get great 3D fills for all canal types. Works with your current oven hand settings

EASY TO RETREAT

GPC is easy to retreat and to prepare for post space

Product Details

These disposable MTA carries are designed to deliver MTA directly to the apex of the root canal and come individually pouched. They can also be used for a broad range of clinical MTA applications, including internal perforation repairs to root-end fillings.

The disposable carries allow for less waste of MTA material and eliminate the need to clean instruments that may become clogged as the MTA material quickly hardens during procedures. Available in 10 packs of 3 sizes: 0.80mm, 0.99mm, and 1.60mm.

Pricing: GPC: \$44.95 PC: \$35.00

One File™ G Thermal Obturators				Pac-File™ Thermal Obturators				Pac-Taper™ Thermal Obturators			
One File™ GPC (Gutta Percha Carrier)		One File™ PC (Plastic Carrier)		Pac-File™ GPC (Gutta Percha Carrier)		Pac-File™ PC (Plastic Carrier)		Pac-Taper™ GPC (Gutta Percha Carrier)		Pac-Taper™ PC (Plastic Carrier)	
5+1Pack	GPC	PC	5+1Pack	GPC	PC	5+1Pack	GPC	5+1Pack	GPC	5+1Pack	PC
#20	5xObturator #20 1x Verifier #20	OOG-20 OOP-20	#20	5xObturator #20 1x Verifier #20	GOB-20 POB-20	#F1 #A1	5xObturator #A1 1x Verifier	TOG-A1	#F1 #A1	5xObturator #A1 1x Verifier	TOP-A1
#25	5xObturator #25 1x Verifier #25	OOG-25 OOP-25	#25	5xObturator #25 1x Verifier #25	GOB-25 POB-25	#F2 #A2	5xObturator #A2 1x Verifier	TOG-A2	#F2 #A2	5xObturator #A2 1x Verifier	TOP-A2
#30	5xObturator #30 1x Verifier #30	OOG-30 --	#30	5xObturator #30 1x Verifier #30	GOB-30 POB-30	#F3 #A3	5xObturator #A3 1x Verifier	TOG-A3	#F3 #A3	5xObturator #A3 1x Verifier	TOP-A3
#35	5xObturator #35 1x Verifier #35	-- OOP-35	#35	5xObturator #35 1x Verifier #35	GOB-35 POB-35	#F4 #A4	5xObturator #A4 1x Verifier	TOG-A4	#F4 #A4	5xObturator #A4 1x Verifier	TOP-A4
#40	5xObturator #40 1x Verifier #40	OOG-40 --	#40	5xObturator #40 1x Verifier #40	GOB-40 POB-40	#F5 #A5	5xObturator #A5 1x Verifier	TOG-A5	#F5 #A5	5xObturator #A5 1x Verifier	TOP-A5
#45	5xObturator #45 1x Verifier #45	-- OOP-45	#45	5xObturator #45 1x Verifier #45	GOB-45 POB-45						
#50	5xObturator #50 1x Verifier #50	-- OOP-45	#50	5xObturator #50 1x Verifier #50	GOB-50 POB-50						



Pac-File™ Conform™ Rotary Files

Comparable to TF® Twisted Files, Vortex Blue®, HyFlex®CM™

- Made of proprietary treated USA nickel-titanium alloy
- Constant Taper design available in .04 and .06 taper and ISO tip sizes 15 - 50
- Can be used with all techniques typically use with constant tapered files.

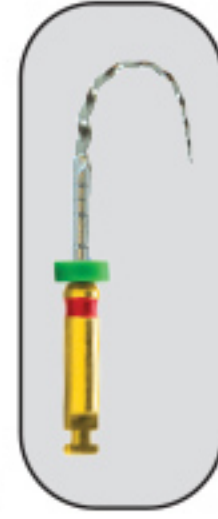

- Can be pre-bent**
- No rebound
 - 490% more resistance against breakage caused by cyclical fatigue

Pac-File™ NiTi™ Rotary Files

Comparable to K3™, Vortex®, HyFlex®NT™, Endosequence®

- Made of premium Super-Elastic USA nickel-titanium alloy
- Ideal for simple straight canals, calcified canals and removing gutta-percha
- Can be used with all techniques typically use with constant tapered files.

Taper	Tip	Rubber Stop Color	Pac-File™ Conform™ 6/pk Gold Handle \$39.50			Pac-File™ NiTi™ 6/pk Silver Handle \$38.50		
			21mm	25mm	31mm	21mm	25mm	31mm
.04	15	Green	FFC210415	FFC250415	FFC310415	FNT210415	FNT250415	FNT310415
.04	20	Yellow	FFC210420	FFC250420	FFC310420	FNT210420	FNT250420	FNT310420
.04	25	Red	FFC210425	FFC250425	FFC310425	FNT210425	FNT250425	FNT310425
.04	30	Blue	FFC210430	FFC250430	FFC310430	FNT210430	FNT250430	FNT310430
.04	35	Light Green	FFC210435	FFC250435	FFC310435	FNT210435	FNT250435	FNT310435
.04	40	Black	FFC210440	FFC250440	FFC310440	FNT210440	FNT250440	FNT310440
.04	45	Light Green	FFC210445	FFC250445	FFC310445	FNT210445	FNT250445	FNT310445
.04	50	Yellow	FFC210450	FFC250450	FFC310450	FNT210450	FNT250450	FNT310450
.04	55	Red	FFC210455	FFC250455	FFC310455	FNT210455	FNT250455	FNT310455
.04	60	Blue	FFC210460	FFC250460	FFC310460	FNT210460	FNT250460	FNT310460
.04	15-40(assorted)	Green	FFC2104AS	FFC2504AS	FFC3104AS	FNT2104AS	FNT2504AS	FNT3104AS
.06	15	Orange	FFC210615	FFC250615	FFC310615	FNT210615	FNT250615	FNT310615
.06	20	Yellow	FFC210620	FFC250620	FFC310620	FNT210620	FNT250620	FNT310620
.06	25	Red	FFC210625	FFC250625	FFC310625	FNT210625	FNT250625	FNT310625
.06	30	Blue	FFC210630	FFC250630	FFC310630	FNT210630	FNT250630	FNT310630
.06	35	Light Green	FFC210635	FFC250635	FFC310635	FNT210635	FNT250635	FNT310635
.06	40	Black	FFC210640	FFC250640	FFC310640	FNT210640	FNT250640	FNT310640
.06	45	Light Green	FFC210645	FFC250645	FFC310645	FNT210645	FNT250645	FNT310645
.06	50	Yellow	FFC210650	FFC250650	FFC310650	FNT210650	FNT250650	FNT310650
.06	15-40(assorted)	Orange	FFC2106AS	FFC2506AS	FFC3106AS	FNT2106AS	FNT2506AS	FNT3106AS
.08	20	Purple	Orifice opener FFC1908OR (19mm)			Orifice opener FNT1908OR (19mm)		

One FILE™ G Reciprocating Files

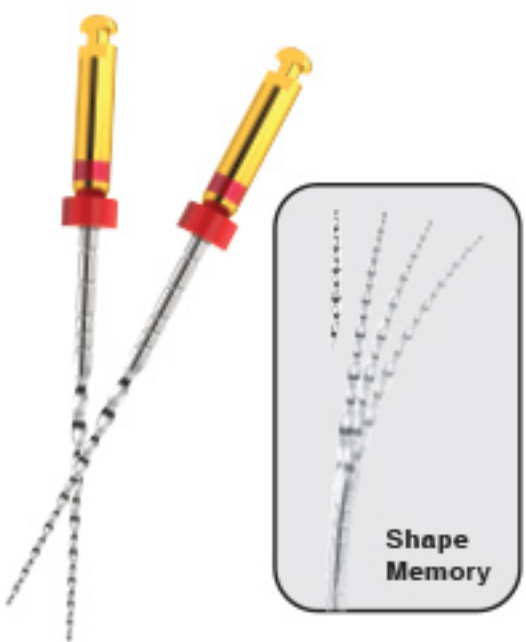

Taper	Tip	21mm	25mm	31mm	
Glide Path File 3/pk					
.02	15	POC2115	POC2515	POC3115	\$29.95
Shaping File 3/pk					
.07	20	POC2120	POC2520	POC3120	\$29.95
.07	25	POC2125	POC2525	POC3125	
.06	35	POC2135	POC2535	POC3135	
.05	45	POC2145	POC2545	POC3145	
Assorted File 5/pk					
AS(15-45)		--	POC25AS	--	\$39.93

PacEndo™ Pre-Filled Irrigation Kit

PacEndo™ Single Canal kit includes:

- 1 X 10 ml pre-filled Sodium Hypochlorite syringe
- 1 X 3 ml pre-filled EDTA syringe
- 1 X 3 ml pre-filled 95% Ethyl Alcohol syringe
- 1 X 3 ml pre-filled Chlorhexidine syringe
- 4 X 30 ga. irrigation needle tips
- 1 X Canal aspirator with tip



\$25.00

\$39.95

EC-1A 4 X PacEndo™ Single Canal kit

EC-1C 4 X PacEndo™ Multiple Canals kit

BONUS BUY for all Orders over \$995 get \$200 credit in high quality Gold diamond Burs \$3.99 and up qualifies.

PacEndo™ iRoot Pro Plus™ #RPCL02

- Compact, continuous and reciprocating cordless base and motor with an accurate built-in apex locator
- Provides highly precise controlled movements, with an apex locator embedded, which gives the advantage of accurate file position readings
- Rotation, torque and the exclusive ability to control angles
- Compatible with the most known rotary and reciprocating endodontic file systems

*\$200 credit In Gold Burs

\$1195
-\$200
\$995

BONUS BUY!



Product Details

PacEndo™ iRoot Pro Plus™ is a compact, continuous and reciprocating ergonomically-designed cordless base and motor with an accurate built-in apex locator. With a hybrid design, the iRoot Pro Plus™ allows the portability of a cordless motor with the easy controls access of a reliable bench motor. Rotation, torque, and the exclusive ability to control angles in reciprocation make the iRoot Pro Plus™ a true open endodontic motor. It is a battery-operated portable cordless endodontic motor electronically connected with the base unit which reduces cord drag, increases mobility, and is compatible with the most known rotary and reciprocating endodontic file systems.

PacEndo™ Vital-Ice™ Pulp Vitality Spray

- A quick way to check cold sensitivity
- Significantly colder than ethyl chloride or ice
- For accuracy use with micro applicators or cotton pellets
- Directional nozzle for easy placement on micro applicator or cotton pellet



PE-VI-01

PacEndo™ Vital-Ice™ 6oz bottle \$24.00

PE-VI-12

PacEndo™ Vital-Ice™ 12 bottles/pk \$279.00

#R1212

\$45.00

Type: 1x10 ml Bottle



GoldBurs.com
PREMIUM MULTI-USE DIAMOND & CARBIDE BURS

800-638-BURS (2877)

Orders@GoldBurs.com

*Credit for Gold Diamond Burs. \$3.99 and up qualify.
Exp Date - Dec 31 2024.