

The MEYER high performance Fork Positioner can hydraulically adjust the forks from the driver's position. Its robust design provides excellent visibility and an optimum fork lift truck residual capacity. The Shaft Guide Concept with solid material hard-chromed shafts and long-life bushings ensures a clean working environment and fast operation speed with synchrofork travel. The optimised design combines highest robustness with an optimum of visibility and residual capacity on the forklift truck.

The integral valve block sideshift of the type range 6-25 allows for an accurate load positioning within the chassis width, while the chassis stays fixed. Many special designs, also with telescopic forks, are available.

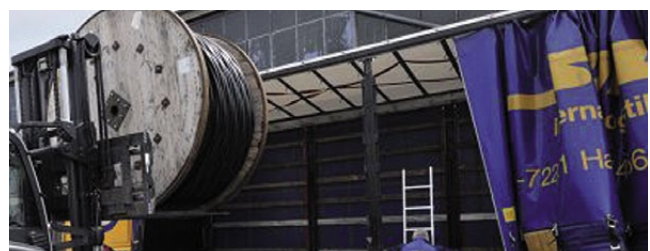

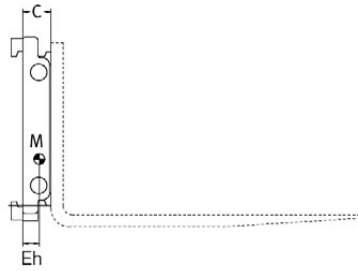
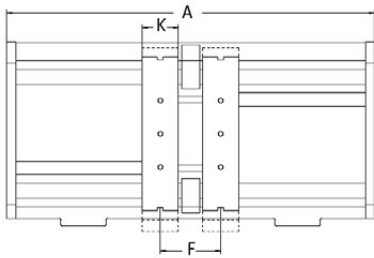

Range: 2500 kg - 14000 kg

Plus:

- Double shaft type fork positioner.
- Accurate fork positioning, thanks to the hydraulic adjustment of the forks within the width of the truck.
- For handling of palletised loads.
- Excellent visibility, strength and versatility.
- Integral side shift.
- Standard lift truck forks can be fitted, without any modification.

	Modell	Capacity	Load Centre	Mounting Class	Chassis Width	Required Truck Carriage Width	Opening Range to Centre of Fork Arm Carrier	Fork Arm Width	Lost Load Centre	Horizontal Centre of Gravity	Weight
		Q kg	LSP mm		ISO Kl.	A mm	mm	F mm	K mm	C mm	Eh mm
a	6-2504G	2500	500	2	730	420	190-540	120	99	43	100
b	6-2504G	2500	500	2	800	490	190-610	120	99	42	109
c	6-2504G	2500	500	2	880	570	190-690	120	99	43	113
d	6-2504G	2500	500	2	1000	690	190-810	120	99	43	123
e	6-2504G	2500	500	2	1050	740	190-860	120	99	42	128
f	6-2504G	2500	500	2	1100	790	190-910	120	99	42	132
g	6-2504G	2500	500	2	1150	840	190-960	120	99	42	136
h	6-2504G	2500	500	2	1200	890	190-1010	120	101	42	157
i	6-2504G	2500	500	2	1250	940	190-1060	120	101	42	161
j	6-2504G	2500	500	2	1300	990	190-1110	120	101	42	165
k	6-2504G	2500	500	2	1400	1090	190-1210	120	101	41	173
l	6-2504G	2500	500	2	1500	1190	190-1310	120	101	41	181
a	6-2505G	2500	600	2	730	420	190-540	120	99	44	109
b	6-2505G	2500	600	2	800	490	190-610	120	99	42	109
c	6-2505G	2500	600	2	880	570	190-690	120	99	44	122
d	6-2505G	2500	600	2	1000	690	190-810	120	99	44	132
e	6-2505G	2500	600	2	1050	740	190-860	120	99	43	137
f	6-2505G	2500	600	2	1100	790	190-910	120	99	43	141
g	6-2505G	2500	600	2	1150	840	190-960	120	99	43	145
h	6-2505G	2500	600	2	1200	890	190-1010	120	101	43	166
i	6-2505G	2500	600	2	1250	940	190-1060	120	101	43	170
j	6-2505G	2500	600	2	1300	990	190-1110	120	101	43	174
k	6-2505G	2500	600	2	1400	1090	190-1210	120	101	42	182
l	6-2505G	2500	600	2	1500	1190	190-1310	120	101	42	191
a	6-2506G	3600	500	3	1100	790	190-910	120	107	46	148
b	6-2506G	3600	500	3	1150	840	190-960	120	107	46	152
c	6-2506G	3600	500	3	1200	890	190-1010	120	110	45	180
d	6-2506G	3600	500	3	1250	990	190-1060	120	110	45	184
e	6-2506G	3600	500	3	1300	990	190-1110	120	110	44	188
f	6-2506G	3600	500	3	1350	1040	190-1160	120	110	44	192
g	6-2506G	3600	500	3	1450	1140	190-1260	120	110	44	200
h	6-2506G	3600	500	3	1550	1240	190-1360	120	110	43	208
i	6-2506G	3600	500	3	1700	1390	190-1510	120	110	43	220
a	6-2510G	5000	600	3	1250	910	240-1010	150	114	52	218
b	6-2510G	5000	600	3	1300	910	240-1060	150	114	52	223
c	6-2510G	5000	600	3	1350	960	240-1110	150	114	52	228
d	6-2510G	5000	600	3	1400	1010	240-1160	150	128	56	251
e	6-2510G	5000	600	3	1450	1060	240-1210	150	128	56	257
f	6-2510G	5000	600	3	1500	1160	240-1260	150	128	55	263
g	6-2510G	5000	600	3	1600	1260	240-1360	150	128	55	275
h	6-2510G	5000	600	3	1700	1360	240-1460	150	128	55	286
i	6-2510G	5000	600	3	1800	1460	240-1560	150	128	55	297

Modell	Capacity	Load Centre		corresponds alternatively		Mounting Class	Chassis Width	Required Truck Carriage Width	Opening Range to Centre of Fork Arm Carrier	Fork Arm Width	Lost Load Centre	Horizontal Centre of Gravity	Weight
		Q	LSP	Q	LSP								
	kg	mm	mm	kg	mm	ISO Kl.	A mm	mm	F mm	K mm	C mm	Eh mm	M kg
a	6-2511G	5500	600			4	1300	1138	240-1050	150	138	54	400
b	6-2511G	5500	600			4	1450	1138	240-1200	150	138	53	425
c	6-2511G	5500	600			4	1550	1138	240-1300	150	138	52	441
d	6-2511G	5500	600			4	1600	1460	240-1350	150	138	52	449
e	6-2511G	5500	600			4	1850	1580	240-1600	150	138	51	490
f	6-2511G	5500	600			4	2000	1600	240-1750	150	138	51	507
g	6-2511G	5500	600			4	2200	1938	240-1950	150	138	50	547
a	6-2512G	6000	600			4	1300	1138	240-1050	150	138	55	403
b	6-2512G	6000	600			4	1450	1138	240-1200	150	138	54	428
c	6-2512G	6000	600			4	1550	1138	240-1300	150	138	53	444
d	6-2512G	6000	600			4	1600	1460	240-1350	150	138	53	452
e	6-2512G	6000	600			4	1850	1580	240-1600	150	138	52	493
f	6-2512G	6000	600			4	2000	1600	240-1750	150	138	52	510
g	6-2512G	6000	600			4	2200	1938	240-1950	150	138	51	550
a	6-2516G	8000	600			4	1400	1100	280-1070	200	140	61	530
b	6-2516G	8000	600			4	1600	1100	280-1270	200	140	60	572
c	6-2516G	8000	600			4	1800	1300	280-1470	200	140	59	614
d	6-2516G	8000	600			4	2000	1500	280-1670	200	140	58	656
e	6-2516G	8000	600			4	2200	1700	280-1870	200	140	57	698
f	6-2516G	8000	600			4	2300	1800	280-1970	200	140	57	719
g	6-2516G	8000	600			4	2400	1900	280-2070	200	140	56	740
a	6-2518G	10000	600			4	1600	1100	280-1270	200	140	60	572
b	6-2518G	10000	600			4	1800	1300	280-1470	200	140	59	614
c	6-2518G	10000	600			4	2000	1500	280-1670	200	140	58	656
d	6-2518G	10000	600			4	2200	1700	280-1870	200	140	57	698
e	6-2518G	10000	600			4	2300	1800	280-1970	200	140	57	719
f	6-2518G	10000	600			4	2400	1900	280-2070	200	140	56	740
a	6-2520G	12000	600	8000	900	4	1800	1300	280-1470	200	140	59	614
b	6-2520G	12000	600	8000	900	4	2000	1500	280-1670	200	140	58	656
c	6-2520G	12000	600	8000	900	4	2200	1700	280-1870	200	140	57	698
d	6-2520G	12000	600	8000	900	4	2300	1800	280-1970	200	140	57	719
e	6-2520G	12000	600	8000	900	4	2400	1900	280-2070	200	140	56	740
a	6-2525G	14500	600	8000	1100	4	2100	1600	280-1780	200	145	54	808
b	6-2525G	14500	600	8000	1100	4	2200	1700	280-1880	200	145	54	833
c	6-2525G	14500	600	8000	1100	4	2300	1800	280-1980	200	145	53	859
d	6-2525G	14500	600	8000	1100	4	2400	1900	280-2080	200	145	53	884

Notes:

- Hydraulic functions required
 - > one for fork positioning
 - > two for fork positioning and sideshifting
- The unit has an integrated sideshift with pressure limitation
- ISO-fork carriers with adjustable securing device (loss prevention)
- ISO arm carriers are fitted with adjustable fork stops for variation in fork widths of up to "K" + 10 mm.
- For use with standard forks (not included in price)
- Fork carriers are pre-drilled with 3 hole pattern, 8 hole pattern for types 6-2516/18/20/25
- Preferred types with short delivery times

Options:

- Alternative frame widths and opening ranges
- Load backrest
- Quick disconnect lower hooks
 - ISO II / III
 - ISO IV
- Special bore pattern
- Special drill holes (for all types except 6-2516/18/20/25, see below)
- Protection of hydraulics connection (for Types 06/09/10 only)
- Version without sideshifting:
- Series G deduct

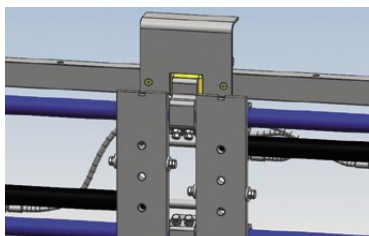

Valve protection
(Type 03/04/05)

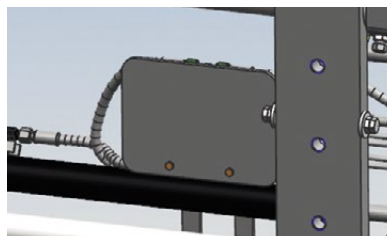

Valve protection
(Type 06/09/10/12)

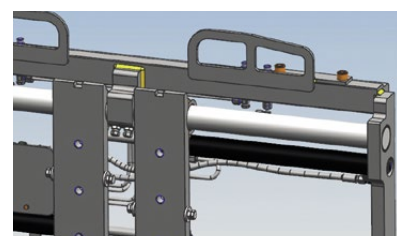

Protection of hydraulics connection
(for Types 06/09/10 only)

Range: 1600 kg - 14000 kg

Plus:

- Double shaft type fork positioner.
- Accurate fork positioning, thanks to the hydraulic adjustment of the forks within the width of the truck.
- For handling of palletised loads.
- Excellent visibility, strength and versatility.
- Integral side shift with bolt-on forks

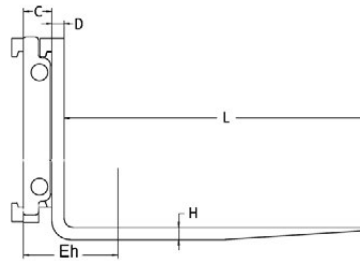
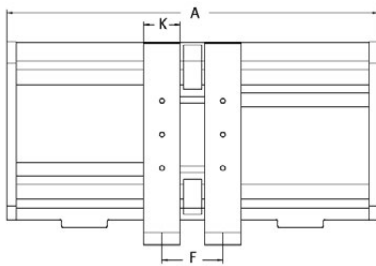

Modell	Capacity	Load Centre	Mounting Class	Chassis Width	Required Truck Carriage Width	Opening Range to Centre of Fork Arm Carrier	Fork Section	Fork Length	Fork Upright	Lost Load Centre	Horizontal Centre of Gravity	Weight
	Q kg	LSP mm	ISO Kl.	A mm	F mm	K x H mm	L mm	D mm	C mm	Eh mm	M kg	
a	6-2503G-Z	1600	500	2A	730	420	190-540	100x40	1200	40	99	199
b	6-2503G-Z	1600	500	2A	800	490	190-610	100x40	1200	40	99	205
c	6-2503G-Z	1600	500	2A	880	570	190-690	100x40	1200	40	99	212
d	6-2503G-Z	1600	500	2A	1000	690	190-810	100x40	1200	40	99	222
e	6-2503G-Z	1600	500	2A	1050	740	190-860	100x40	1200	40	99	217
f	6-2503G-Z	1600	500	2A	1100	790	190-910	100x40	1200	40	99	231
g	6-2503G-Z	1600	500	2A	1150	840	190-960	100x40	1200	40	99	235
h	6-2503G-Z	1600	500	2A	1200	890	190-1010	100x40	1200	40	101	256
i	6-2503G-Z	1600	500	2A	1250	940	190-1060	100x40	1200	40	101	260
j	6-2503G-Z	1600	500	2A	1300	990	190-1110	100x40	1200	40	101	264
k	6-2503G-Z	1600	500	2A	1400	1090	190-1210	100x40	1200	40	101	272
l	6-2503G-Z	1600	500	2A	1500	1190	190-1310	100x40	1200	40	101	280
Additional price per 100 mm Fork length up to and including 1500 mm.												
Above 1500 mm to 2400 mm with fork section 120 x 40 mm.												
a	6-2504G-Z	2500	500	2A	730	420	190-540	120X40	1200	40	99	226
b	6-2504G-Z	2500	500	2A	800	490	190-610	120X40	1200	40	99	224
c	6-2504G-Z	2500	500	2A	880	570	190-690	120X40	1200	40	99	239
d	6-2504G-Z	2500	500	2A	1000	690	190-810	120X40	1200	40	99	249
e	6-2504G-Z	2500	500	2A	1050	740	190-860	120X40	1200	40	99	254
f	6-2504G-Z	2500	500	2A	1100	790	190-910	120X40	1200	40	99	258
g	6-2504G-Z	2500	500	2A	1150	840	190-960	120X40	1200	40	99	262
h	6-2504G-Z	2500	500	2A	1200	890	190-1010	120x40	1200	40	101	267
i	6-2504G-Z	2500	500	2A	1250	940	190-1060	120X40	1200	40	101	271
j	6-2504G-Z	2500	500	2A	1300	990	190-1110	120X40	1200	40	101	275
k	6-2504G-Z	2500	500	2A	1400	1090	190-1210	120X40	1200	40	101	283
l	6-2504G-Z	2500	500	2A	1500	1190	190-1310	120x40	1200	40	101	292
Additional price per 100 mm Fork length up to and including 1500 mm.												
Above 1500 mm to 2400 mm with fork section 120 x 50 mm.												
a	6-2505G-Z	2500	600	2A	730	420	190-540	120X45	1200	45	99	249
b	6-2505G-Z	2500	500	2A	800	490	190-610	120X45	1200	45	99	239
c	6-2505G-Z	2500	600	2A	880	570	190-690	120X45	1200	45	99	262
d	6-2505G-Z	2500	600	2A	1000	690	190-810	120X45	1200	45	99	272
e	6-2505G-Z	2500	600	2A	1050	740	190-860	120X45	1200	45	99	277
f	6-2505G-Z	2500	600	2A	1100	790	190-910	120X45	1200	45	99	281
g	6-2505G-Z	2500	600	2A	1150	840	190-960	120X45	1200	45	99	285
e	6-2505G-Z	2500	600	2A	1200	890	190-1010	120x45	1200	45	101	306
f	6-2505G-Z	2500	600	2A	1250	940	190-1060	120X45	1200	45	101	310
g	6-2505G-Z	2500	600	2A	1300	990	190-1110	120X45	1200	45	101	314
h	6-2505G-Z	2500	600	2A	1400	1090	190-1210	120X45	1200	45	101	322
i	6-2505G-Z	2500	600	2A	1500	1190	190-1310	120x45	1200	45	101	331
Additional price per 100 mm Fork length up to and including 1500 mm.												
Above 1500 mm to 2400 mm with fork section 120 x 50 mm.												

Modell	Capacity	Load Centre		Mounting Class	Chassis Width	Required Truck Carriage Width	Opening Range to Centre of Fork Arm Carrier	Fork Section	Fork Length	Fork Upright	Lost Load Centre	Horizontal Centre of Gravity	Weight
		Q	LSP										
	kg	mm	mm	Kl.	mm	mm	mm	mm	mm	mm	mm	mm	kg
a	6-2506G-Z	3600	500	3A	1100	790	190-910	120X45	1200	45	107	236	288
b	6-2506G-Z	3600	500	3A	1150	840	190-960	120X45	1200	45	107	233	292
c	6-2506G-Z	3600	500	3A	1200	890	190-1010	120X45	1200	45	110	218	320
d	6-2506G-Z	3600	500	3A	1250	990	190-1060	120X45	1200	45	110	215	324
e	6-2506G-Z	3600	500	3A	1300	990	190-1110	120X45	1200	45	110	213	328
f	6-2506G-Z	3600	500	3A	1350	1040	190-1160	120X45	1200	45	110	211	332
g	6-2506G-Z	3600	500	3A	1450	1140	190-1260	120X45	1200	45	110	207	340
h	6-2506G-Z	3600	500	3A	1550	1240	190-1360	120X45	1200	45	110	203	348
i	6-2506G-Z	3600	500	3A	1700	1390	190-1510	120x45	1200	45	110	197	360
Additional price per 100 mm Fork length up to and including 1500 mm.													
Above 1500 mm to 2400 mm with fork section 120 x 50 mm.													
a	6-2509G-Z	4500	600	3A	1250	910	240-1010	140x50	1200	50	114	234	389
b	6-2509G-Z	4500	600	3A	1300	910	240-1060	140X50	1200	50	114	232	394
c	6-2509G-Z	4500	600	3A	1350	960	240-1110	140X50	1200	50	114	230	399
d	6-2509G-Z	4500	600	3A	1400	1010	240-1160	140x50	1200	50	128	229	422
e	6-2509G-Z	4500	600	3A	1450	1060	240-1210	140X50	1200	50	128	227	428
f	6-2509G-Z	4500	600	3A	1500	1160	240-1260	140X50	1200	50	128	224	434
g	6-2509G-Z	4500	600	3A	1600	1260	240-1360	140X50	1200	50	128	219	446
h	6-2509G-Z	4500	600	3A	1700	1360	240-1460	140x50	1200	50	128	215	457
i	6-2509G-Z	4500	600	3A	1800	1460	240-1560	140X50	1200	50	128	211	469
Additional price per 100 mm Fork length up to and including 1500 mm.													
Above 1500 mm to 2400 mm with fork section 150 x 50 mm.													
a	6-2510G-Z	5000	600	3A	1250	910	240-1010	130x60	1200	60	114	240	418
b	6-2510G-Z	5000	600	3A	1300	910	240-1060	130X60	1200	60	114	238	423
c	6-2510G-Z	5000	600	3A	1350	916	240-1110	130X60	1200	60	114	236	428
d	6-2510G-Z	5000	600	3A	1400	1010	240-1160	130x60	1200	60	128	236	451
e	6-2510G-Z	5000	600	3A	1450	1060	240-1210	130X60	1200	60	128	234	457
f	6-2510G-Z	5000	600	3A	1500	1160	240-1260	130X60	1200	60	128	231	463
g	6-2510G-Z	5000	600	3A	1600	1260	240-1360	130X60	1200	60	128	226	475
h	6-2510G-Z	5000	600	3A	1700	1360	240-1460	130x60	1200	60	128	223	486
i	6-2510G-Z	5000	600	3A	1800	1460	240-1560	130X60	1200	60	128	219	497
Additional price per 100 mm Fork length up to and including 1500 mm.													
Above 1500 mm to 2400 mm with fork section 150 x 60 mm.													
a	6-2511G-Z	5500	600	4A	1300	1138	240-1050	150x60	1200	60	138	218	675
b	6-2511G-Z	5500	600	4A	1450	1138	240-1200	150x60	1200	60	138	213	700
c	6-2511G-Z	5500	600	4A	1550	1138	240-1300	150x60	1200	60	138	209	716
d	6-2511G-Z	5500	600	4A	1600	1460	240-1350	150x60	1200	60	138	207	724
e	6-2511G-Z	5500	600	4A	1850	1580	240-1600	150x60	1200	60	138	204	765
f	6-2511G-Z	5500	600	4A	2000	1600	240-1750	150x60	1200	60	138	203	783
g	6-2511G-Z	5500	600	4A	2200	1938	240-1950	150x60	1200	60	138	202	822
Additional price per 100 mm Fork length up to and including 1500 mm.													
Above 1500 mm to 2400 mm with fork section 150 x 60 mm.													

Notes:

- Hydraulic functions required
 - > one for fork positioning
 - > two for fork positioning and sideshifting
- The unit has an integrated sideshift with pressure limitation
- Fork carriers are pre-drilled with 3 hole pattern, 8 hole pattern for types 6-2516/18/20/25

Options:

- Alternative frame widths and opening ranges
- Load backrest
- Quick disconnect lower hooks
 - ISO II / III
 - ISO IV
- Special bolt pattern
- Valve protection (for all Types except 6-2516/18/20/25 where the valve is protected)
- Protection of hydraulics connection
- Hydraulic flow
- Version without sideshifting: Series G price reduction
- Non-slip coating for forks

Modell	Capacity	Load Centre		corresponds alternatively		Mounting Class	Chassis Width	Required Truck Carriage Width	Opening Range to Centre of Fork Arm Carrier	Fork Section	Fork Length	Fork Upright	Lost Load Centre	Horizontal Centre of Gravity	Weight
		Q kg	LSP mm	Q kg	LSP mm										
a	6-2512G-Z	6000	600			4A	1300	1138	240-1050	150x60	1200	60	138	219	678
b	6-2512G-Z	6000	600			4A	1450	1138	240-1200	150x60	1200	60	138	214	703
c	6-2512G-Z	6000	600			4A	1550	1138	240-1300	150x60	1200	60	138	210	719
d	6-2512G-Z	6000	600			4A	1600	1460	240-1350	150x60	1200	60	138	208	727
e	6-2512G-Z	6000	600			4A	1850	1580	240-1600	150x60	1200	60	138	205	768
f	6-2512G-Z	6000	600			4A	2000	1600	240-1750	150x60	1200	60	138	204	785
g	6-2512G-Z	6000	600			4A	2200	1938	240-1950	150x60	1200	60	138	203	825
Additional price per 100 mm Fork length up to and including 1500 mm.															
Above 1500 mm to 2400 mm with fork section 150 x 60 mm.															
a	6-2516G-Z	8000	600			4A	1400	1100	280-1070	150x70	1200	70	140	209	847
b	6-2516G-Z	8000	600			4A	1600	1100	280-1270	150x70	1200	70	140	201	889
c	6-2516G-Z	8000	600			4A	1800	1300	280-1470	150x70	1200	70	140	194	931
d	6-2516G-Z	8000	600			4A	2000	1500	280-1670	150x70	1200	70	140	188	973
e	6-2516G-Z	8000	600			4A	2200	1700	280-1870	150x70	1200	70	140	183	1015
f	6-2516G-Z	8000	600			4A	2300	1800	280-1970	150x70	1200	70	140	181	1036
g	6-2516G-Z	8000	600			4A	2400	1900	280-2070	150x70	1200	70	140	179	1057
Additional price per 100 mm Fork length up to and including 2400 mm.															
Additional price change in fork section 200x60 mm one time.															
a	6-2518G-Z	10000	600			4A	1600	1100	280-1270	200x70	1200	70	140	227	988
b	6-2518G-Z	10000	600			4A	1800	1300	280-1470	200x70	1200	70	140	219	1030
c	6-2518G-Z	10000	600			4A	2000	1500	280-1670	200x70	1200	70	140	212	1072
d	6-2518G-Z	10000	600			4A	2200	1700	280-1870	200x70	1200	70	140	206	1114
e	6-2518G-Z	10000	600			4A	2300	1800	280-1970	200x70	1200	70	140	204	1135
f	6-2518G-Z	10000	600			4A	2400	1900	280-2070	200x70	1200	70	140	201	1156
Additional price per 100 mm Fork length up to and including 2400 mm.															
a	6-2520G-Z	12000	600	8000	900	4A	1800	1300	280-1470	200x70	1200	70	140	219	1030
b	6-2520G-Z	12000	600	8000	900	4A	2000	1500	280-1670	200x70	1200	70	140	212	1072
c	6-2520G-Z	12000	600	8000	900	4A	2200	1700	280-1870	200x70	1200	70	140	206	1114
d	6-2520G-Z	12000	600	8000	900	4A	2300	1800	280-1970	200x70	1200	70	140	204	1135
e	6-2520G-Z	12000	600	8000	900	4A	2400	1900	280-2070	200x70	1200	70	140	201	1156
Additional price per 100 mm Fork length up to and including 2400 mm.															
a	6-2525G-Z	14500	600	8000	1100	4A	2100	1600	280-1780	200x80	1200	80	145	208	1280
b	6-2525G-Z	14500	600	8000	1100	4A	2200	1700	280-1880	200x80	1200	80	145	204	1305
c	6-2525G-Z	14500	600	8000	1100	4A	2300	1800	280-1980	200x80	1200	80	145	201	1331
d	6-2525G-Z	14500	600	8000	1100	4A	2400	1900	280-2080	200x80	1200	80	145	199	1356
Additional price per 100 mm Fork length up to and including 2400 mm.															

Notes:

- Hydraulic functions required
 - > one for fork positioning
 - > two for fork positioning and sideshifting
- The unit has an integrated sideshift with pressure limitation
- Fork carriers are pre-drilled with 3 hole pattern, 8 hole pattern for types 6-2516/18/20/25

Options:

- Alternative frame widths and opening ranges
- Load backrest
- Quick disconnect lower hooks
 - ISO II / III
 - ISO IV
- Special bolt pattern
- Valve protection (for all Types except 6-2516/18/20/25 where the valve is protected behind the center bar)
- Protection of hydraulics connection
- Hydraulic flow
- Version without sideshifting: Series G price reduction
- Non-slip coating for forks

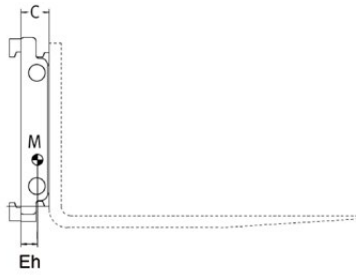
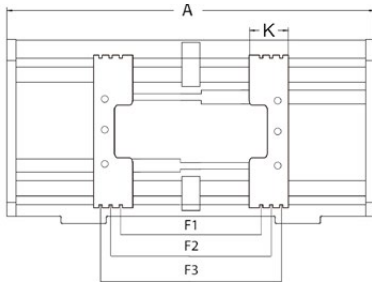

Range: 2500 kg - 5000 kg

Plus:

- The special Automotive Execution of the MEYER shaft-guided Fork Positioner is designed around the particular demand of the logistic processes in the automotive industry.
- With integral (valve block) sideshift.

Modell	Capacity	Load Centre	Mounting Class	Chassis Width	Required Truck Carriage Width	Opening Range to Centre of Fork Arm Carrier			Fork Arm Width	Lost Load Centre	Horizontal Centre of Gravity	Weight	
						F1	F2	F3					
	Q kg	LSP mm	ISO Kl.	A mm	mm	mm	mm	mm	mm	mm	mm	kg	
a	6-2504A	2.500	500	2	730	420	150-500	250-600	350-700	220	119	48	109
b	6-2504A	2.500	500	2	800	490	150-570	250-670	350-770	220	119	48	118
c	6-2504A	2.500	500	2	880	570	150-650	250-750	350-850	220	119	48	122
d	6-2504A	2.500	500	2	1000	690	150-770	250-870	350-970	220	119	48	132
e	6-2504A	2.500	500	2	1050	740	150-820	250-920	350-1020	220	119	47	137
f	6-2504A	2.500	500	2	1100	790	150-870	250-970	350-1070	220	119	47	141
g	6-2504A	2.500	500	2	1150	840	150-920	250-1020	350-1120	220	119	47	145
h	6-2504A	2.500	500	2	1200	890	150-970	250-1070	350-1170	220	121	47	163
i	6-2504A	2.500	500	2	1250	940	150-1020	250-1120	350-1220	220	121	47	170
j	6-2504A	2.500	500	2	1300	990	150-1070	250-1170	350-1270	220	121	47	174
k	6-2504A	2.500	500	2	1400	1090	150-1170	250-1270	350-1370	220	121	46	182
l	6-2504A	2.500	500	2	1500	1190	150-1270	250-1370	350-1470	220	121	46	190
a	6-2505A	2.500	600	2	730	420	150-500	250-600	350-700	220	119	49	118
b	6-2505A	2.500	600	2	800	490	150-570	250-670	350-770	220	119	49	122
c	6-2505A	2.500	600	2	880	570	150-650	250-750	350-850	220	119	49	131
d	6-2505A	2.500	600	2	1000	690	150-770	250-870	350-970	220	119	49	141
e	6-2505A	2.500	600	2	1050	740	150-820	250-920	350-1020	220	119	48	146
f	6-2505A	2.500	600	2	1100	790	150-870	250-970	350-1070	220	119	48	150
g	6-2505A	2.500	600	2	1150	840	150-920	250-1020	350-1120	220	119	48	154
h	6-2505A	2.500	600	2	1200	890	150-970	250-1070	350-1170	220	121	48	175
i	6-2505A	2.500	600	2	1250	940	150-1020	250-1120	350-1220	220	121	48	179
j	6-2505A	2.500	600	2	1300	990	150-1070	250-1170	350-1270	220	121	48	183
k	6-2505A	2.500	600	2	1400	1090	150-1170	250-1270	350-1370	220	121	47	191
l	6-2505A	2.500	600	2	1500	1190	150-1270	250-1370	350-1470	220	121	47	200
a	6-2506A	3.600	500	3	1100	790	150-870	250-970	350-1070	220	137	54	163
b	6-2506A	3.600	500	3	1150	840	150-920	250-1020	350-1120	220	137	54	167
c	6-2506A	3.600	500	3	1200	890	150-970	250-1070	350-1170	220	140	64	195
d	6-2506A	3.600	500	3	1250	990	150-1020	250-1120	350-1220	220	140	53	199
e	6-2506A	3.600	500	3	1300	990	150-1070	250-1170	350-1270	220	140	64	203
f	6-2506A	3.600	500	3	1350	1040	150-1120	250-1220	350-1320	220	140	63	207
g	6-2506A	3.600	500	3	1450	1140	150-1220	250-1320	350-1420	220	140	63	215
h	6-2506A	3.600	500	3	1550	1240	150-1320	250-1420	350-1520	220	140	63	223
i	6-2506A	3.600	500	3	1700	1390	150-1470	250-1570	350-1670	220	140	63	235
a	6-2510A	5.000	600	3	1250	910	180-950	250-1020	430-1200	285	144	61	237
b	6-2510A	5.000	600	3	1300	910	180-1000	250-1070	430-1250	285	144	61	242
c	6-2510A	5.000	600	3	1350	960	180-1050	250-1120	430-1300	285	144	61	247
d	6-2510A	5.000	600	3	1400	1010	180-1100	250-1170	430-1350	285	158	65	268
e	6-2510A	5.000	600	3	1450	1060	180-1150	250-1220	430-1400	285	158	65	274
f	6-2510A	5.000	600	3	1500	1160	180-1200	250-1270	430-1450	285	158	64	280
g	6-2510A	5.000	600	3	1600	1260	180-1300	250-1370	430-1550	285	158	64	293
h	6-2510A	5.000	600	3	1700	1360	180-1400	250-1470	430-1650	285	158	64	303
i	6-2510A	5.000	600	3	1800	1460	180-1500	250-1570	430-1750	285	158	64	314

Notes:

- Additional hydraulics required
 > one
 > two if sideshift required
- ISO arm carriers are fitted with adjustable fork stops
- Maximum fork section in position F1 and F3:
 - 6-2504/05/06 130 mm
 - 6-2510 160 mm

- For use with standard forks (not included in price)
- Arm carriers are predrilled with 3 holes
- Hydraulic flow and operating pressure

Options:

- Other capacities and opening ranges
- Load Backrest
- Quick disconnect lower hooks - ISO II / III
- Special drill holes
- Valve protection (only for Model 6-2504/05)
- Non-sideshifting models

Model 6-25G-T (with telescopic forks, integral sideshift)

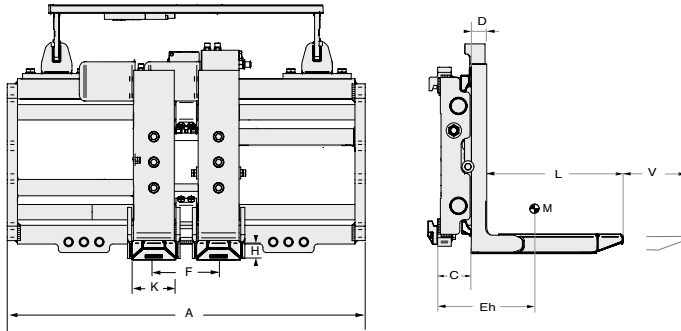

Range: 2500 kg - 5800 kg

Plus:

- The combination of the proven MEYER fork positioner with quality telescopic forks enable the flexible handling and transport of different load dimensions as well as double deep stacking into racking and loading and unloading of road trucks from one side. The telescopic forks are mounted onto the precision shaft guide of the MEYER fork positioner.

Modell	Capacity	Capacity	Load Centre	Mounting Class	for FLT capacity max.	chassis width	Required Truck Carriage Width	opening range over forks	Fork Section	Fork Length	Stroke	Fork upright	Lost Load Centre	Centre of gravity retracted	Centre of gravity extended	Weight	
	Q	Q1	LSP	ISO	t/LSP	A	mm	F	KxH	L	V	D	C	E	E	M	
	kg	kg	mm	Kl.	t/LSP	mm	mm	mm	mm	mm	mm	mm	mm	mm	mm	kg	
a	6-2503G-T	2.000	1000/1025	500	2A	2,0/500	880	680	190-690	130x57	1200	850	45	99	320	435	280
b	6-2503G-T	2.000	900/1175	500	2A	2,0/500	880	680	190-690	130x57	1350	1000	45	99	375	510	295
c	6-2503G-T	2.000	1000/1025	500	2A	2,0/500	1050	850	190-860	130x57	1200	850	45	99	305	415	295
d	6-2503G-T	2.000	900/1175	500	2A	2,0/500	1050	850	190-860	130x57	1350	1000	45	99	360	490	310
a	6-2504G-T	2.500	1250/1025	500	2A	2,5/500	1050	850	190-860	130x57	1200	850	45	99	310	420	300
b	6-2504G-T	2.500	1100/1175	500	2A	2,5/500	1050	850	190-860	130x57	1350	1000	45	99	360	495	315
c	6-2504G-T	2.500	1250/1025	500	2A	2,5/500	1150	950	190-960	130x57	1200	850	45	99	305	410	310
d	6-2504G-T	2.500	1100/1175	500	2A	2,5/500	1150	950	190-960	130x57	1350	1000	45	99	355	485	320
e	6-2504G-T	2.500	1250/1025	500	2A	2,5/500	1300	1100	190-1110	130x57	1200	850	45	101	280	380	335
f	6-2504G-T	2.500	1100/1175	500	2A	2,5/500	1300	1100	190-1110	130x57	1350	1000	45	101	330	450	350
a	6-2505G-T	2.500	1500/1025	600	2A	2,5/600	1100	900	190-910	130x57	1200	850	45	99	300	405	315
b	6-2505G-T	2.500	1300/1175	600	2A	2,5/600	1100	900	190-910	130x57	1350	1000	45	99	350	480	330
c	6-2505G-T	2.500	1500/1025	600	2A	2,5/600	1200	1000	190-1010	130x57	1200	850	45	101	280	380	340
d	6-2505G-T	2.500	1300/1175	600	2A	2,5/600	1200	1000	190-1010	130x57	1350	1000	45	101	330	450	350
e	6-2505G-T	2.500	1500/1025	600	2A	2,5/600	1300	1100	190-1110	130x57	1200	850	45	101	275	370	345
f	6-2505G-T	2.500	1300/1175	600	2A	2,5/600	1300	1100	190-1110	130x57	1350	1000	45	101	320	440	360
a	6-2506G-T	3.600	1750/1025	500	3A	4,0/500	1150	950	190-960	130x57	1200	850	45	107	290	390	330
b	6-2506G-T	3.600	1530/1175	500	3A	4,0/500	1150	950	190-960	130x57	1350	1000	45	107	335	455	345
c	6-2506G-T	3.600	1750/1025	500	3A	4,0/500	1250	1050	190-1060	130x57	1200	850	45	110	270	355	360
d	6-2506G-T	3.600	1530/1175	500	3A	4,0/500	1250	1050	190-1060	130x57	1350	1000	45	110	310	425	375
e	6-2506G-T	3.600	1750/1025	500	3A	4,0/500	1350	1150	190-1160	130x57	1200	850	45	110	265	350	370
f	6-2506G-T	3.600	1530/1175	500	3A	4,0/500	1350	1150	190-1160	130x57	1350	1000	45	110	305	415	385
a	6-2509G-T	4.500	2600/1025	600	3A	5,0/500	1250	1050	240-1010	160x57	1200	850	45	114	275	365	425
b	6-2509G-T	4.500	2300/1175	600	3A	5,0/500	1250	1050	240-1010	160x57	1350	1000	45	114	315	435	440
c	6-2509G-T	4.500	2600/1025	600	3A	5,0/500	1350	1150	240-1110	160x57	1200	850	45	114	270	360	435
d	6-2509G-T	4.500	2300/1175	600	3A	5,0/600	1350	1150	240-1110	160x57	1350	1000	45	114	310	425	450
e	6-2509G-T	4.500	2600/1025	600	3A	5,0/600	1450	1250	240-1210	160x57	1200	850	45	128	265	350	465
f	6-2509G-T	4.500	2300/1175	600	3A	5,0/600	1450	1250	240-1210	160x57	1350	1000	45	128	305	415	480
a	6-2512G-T	5.800	3400/1025	600	4A	6,0/600	1500	1135	230-1250	170x62	1200	850	50	138	208	284	722
b	6-2512G-T	5.800	3000/1175	600	4A	6,0/600	1500	1135	230-1250	170x62	1350	1000	50	138	240	334	742
c	6-2512G-T	5.800	3400/1025	600	4A	6,0/600	1800	1610	230-1550	170x62	1200	850	50	138	195	265	788
d	6-2512G-T	5.800	3000/1175	600	4A	6,0/600	1800	1610	230-1550	170x62	1350	1000	50	138	225	312	808

Notes:

- Hydraulic functions required
> two for the use of the fork adjustment function and telescopic forks
- The integrated sideshift is controlled by a solenoid valve, **included in the price and scope of delivery.** (Please specify voltage when ordering!)
- Telescopic tines are additionally bolted 3 times
- Including wear protection under outer forks (6-2503/04/05/06/09G-T)
- Hydraulic flow and working pressure

Options:

- Special pallet stop thickness 150 mm
- ISO 2328 mounting class B
- Wear protection under outer forks (for 6-2512G-T)
- Eliminated price solenoid valve, reduced price (without sideshift)
- Alternative widths and fork lengths