

Before operating this unit, please read these instructions completely.

# SWIFT 3D-EPP

## Instruction Manual



**Features:**

1. SWIFT 3D-EPP is a super model for 3D aerobatic flying. It's made of "almost unbreakable" EPP material and by the modern technology in CNC machines.
2. The flying time of SWIFT 3D-EPP is 8-15 minutes, it depends on the flying figures. The model is able to "torque roll" and then after giving more "gas" to rise vertically up, looping in "knife" flight and all aerobatic figures.
3. Easy to landing.
4. Easy to assemble, most of the parts are pre-assembled in our factory.

**Product Specifications**

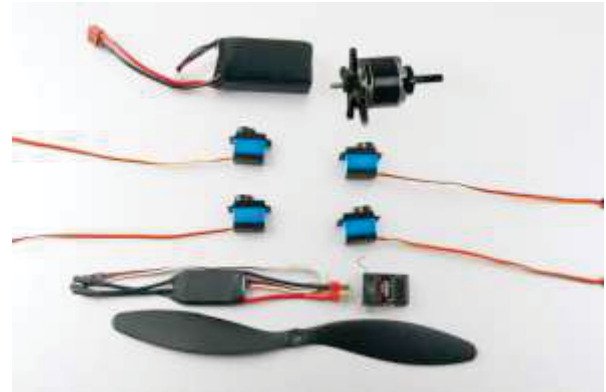

**Product Specifications**

- Fuselage length: 1180mm (46.5in.)
- Wingspan: 1200mm (47.2in.)
- Flying Weight: 810--900g (with battery)
- Motor: AT2814 KV 1000
- ESC: 40 Amp
- Propeller: 11x4.7sf or 12x3.8 sf
- Servo: 12-16g micro servo\*4pcs
- Radio: 4/more channel
- Battery: 11.1V 1500-2200mAh Li-po 25C

**Do not fly under the conditions as below**

- Wind strong enough to make the trees rustle
- A street with many trees or street lamps
- Close to high voltage electrical wires
- High Population density areas

**Cautions for flying**

Front lawns and parks make excellent flying areas. Make sure you have permission to fly and follow safety guidelines set by local authorities. The calmer the wind, the better!

**Note for Storage**

Please disconnect the lipo packs when finished flying  
Do not press or crush the airplane when storing  
The best way to store is to hang the airplane to keep the control surface rigid

**Recommended Flying Setup**

- Max servo travel of aileron: 50degrees up and 50degrees down (90mm)
- Max servo travel of elevator: 50 degrees up and 50 degrees down (80mm)
- Max servo travel of rudder: 55degrees left and 55 degrees right (110mm)

**CG Position:**

120-130mm from the leading edge of the wing.



parts included in the packing



- |                          |      |
|--------------------------|------|
| 1 Wing (right and left)  | 1pc  |
| 2 Rudder (vertical tail) | 1pc  |
| 3 Elevator (stabilizer)  | 1pc  |
| 4 Carbon rods 2*1000mm   | 2pcs |
| 5 Fuselage               | 1pc  |
| 6 Canopy                 | 1pc  |



1. Use CA to glue right and left wing together. To avoid distortion, this step need to be handled on a flat surface.

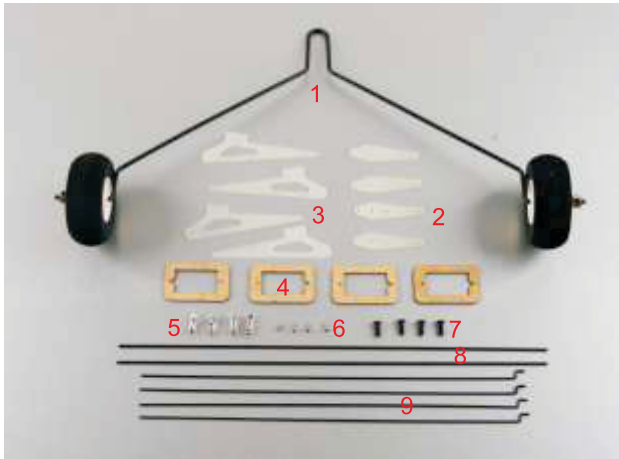

- |                                     |      |
|-------------------------------------|------|
| 1 Landing gear system               | 1pc  |
| 2 Extension servo arm               | 4pcs |
| 3 Aileron & Elevator & Rudder horn  | 4pcs |
| 4 Plywood servo mount               | 4pcs |
| 5 Pushrod connector                 | 4pcs |
| 6 Screw 1.5*5mm                     | 4pcs |
| 7 Screw 3*8mm                       | 4pcs |
| 8 Stab. Brace carbon rods 1.3*230mm | 2pcs |
| 9 Z bend 1.2*200mm                  | 4pcs |



2. Install 2pcs 2\*1000mm carbon rods to the pre-reserved slots on upside and downside surface of wing, then use CA to fix.

The items below are required for assembly

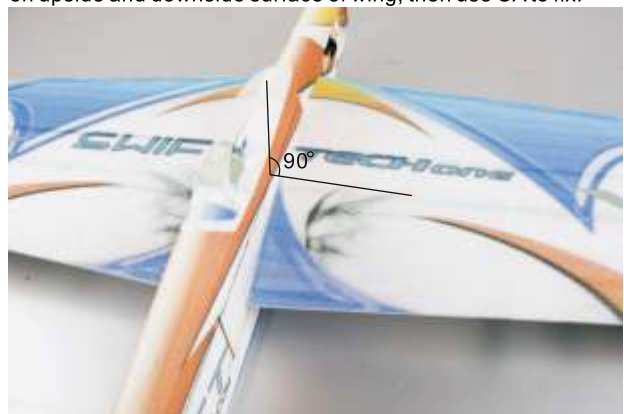

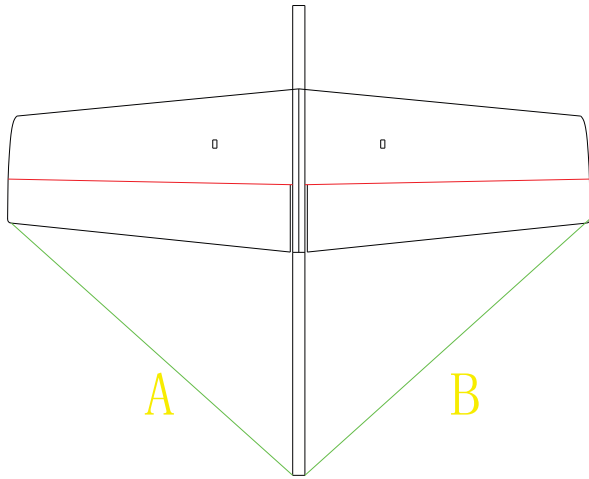

$$A=B$$

3. Insert the wing into the slot of fuselage and use glue to fix. Make sure  $A=B$  (refer to above picture)



4. Drop some glue on the joints of fuselage and wing to fix (both upside and downside).



5. Glue the canopy

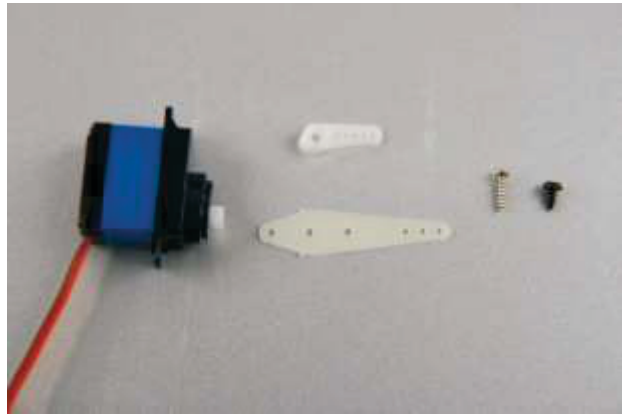

6. Fix the servo extension arm onto the servo arm with screw .



7. Install the pushrod connector onto the extension arm .





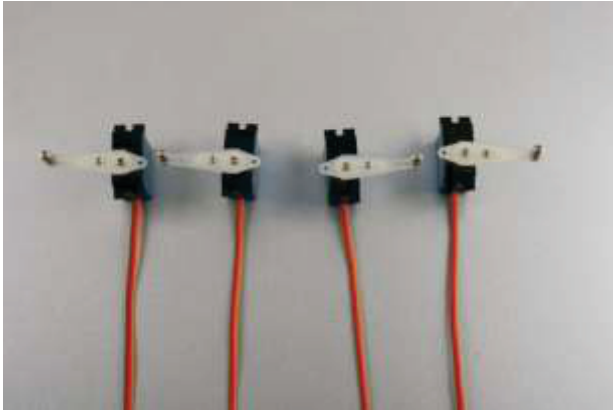

8. Fix the servo arm by using the servo package which included.

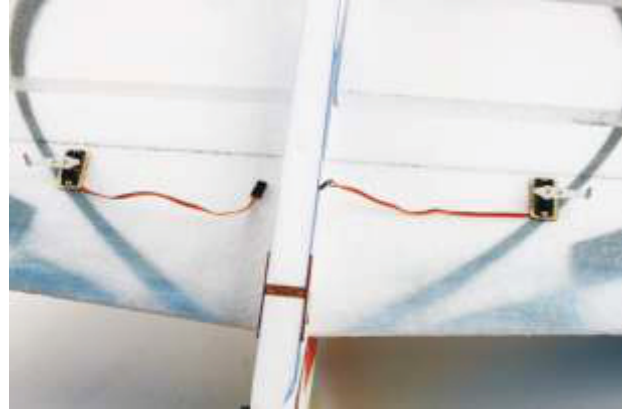

12. Use the same method to install the aileron servos

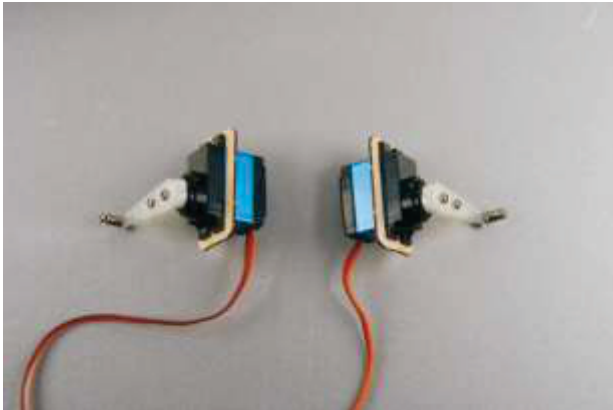

9. Install the servo mount as picture shown.

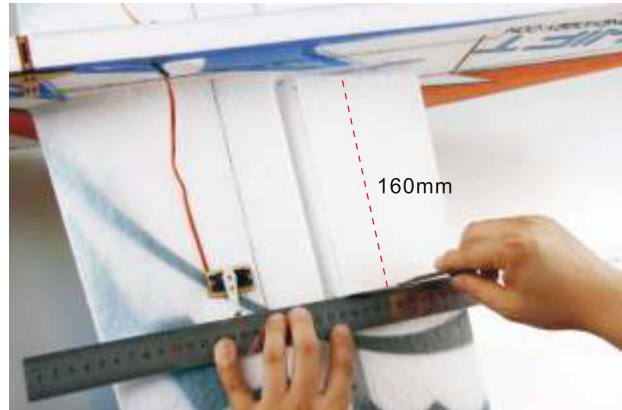

13. Pls use a hobby knife to cut a slot which is vertical to the servo arm , so that can install the servo control horn easily .



10. Put the servo into the pre-cut servo hole, then use glue to fix the servo mount onto the wing. Make sure the servo arm point to the wingtip.



14. Connect the aileron horns to one side of the Z bend.

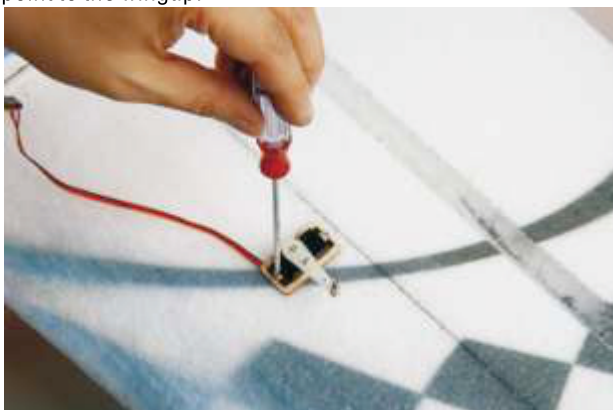

11. And fix the servos onto the plywood servo mount with included screws.

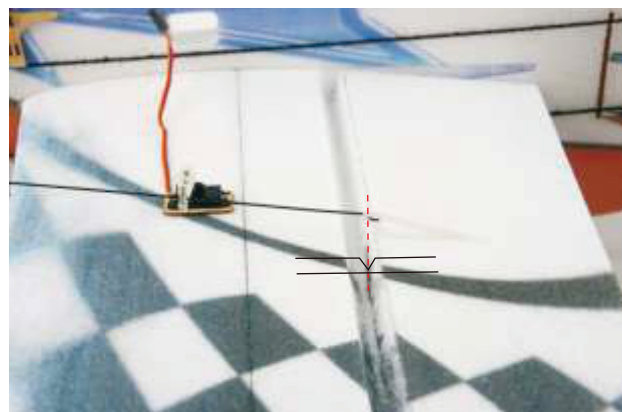

15. Through the other side of the Z bend to the hole of pushrod connector , and then insert the aileron horn into the pre-cut slot.



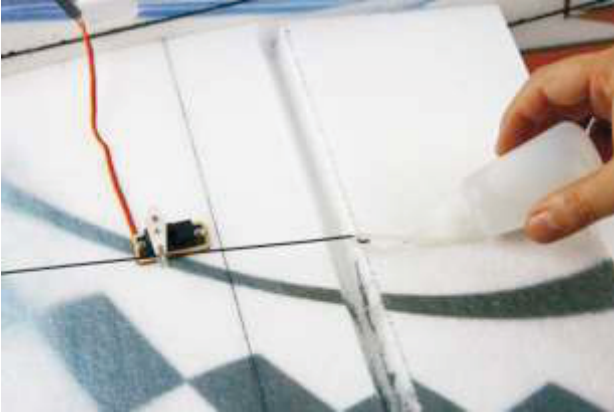

16. Glue the control horn by using the CA .



17. Use the screwdriver to tighten the pushrod connector with screws.



18. Use the same method to install the aileron pushrod.



19. Use the pinchers to cut off the superfluous steel wire.

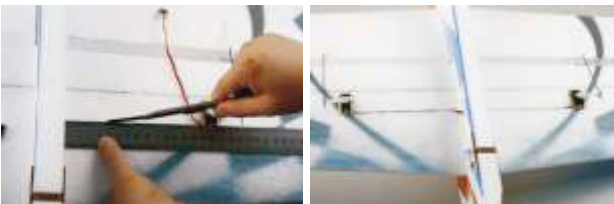

20. Use knife to cut slots on wing, then embed aileron servo leads as picture shown.

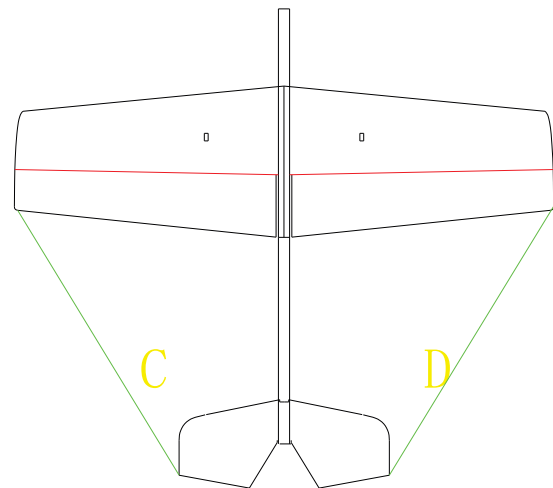
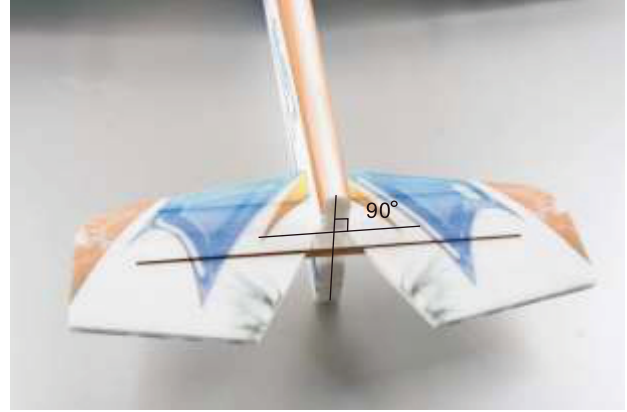

C=D

21. Insert elevator into the slot of fuselage. Make sure C=D (refer to the picture).

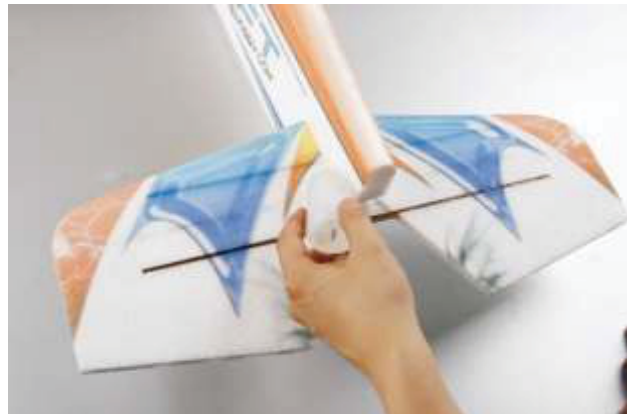

22. Drop some glue on the joints of elevator and fuselage to fix.

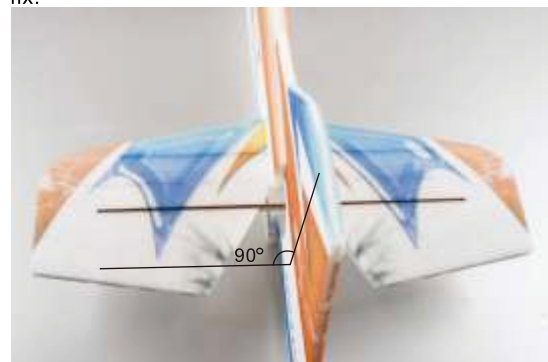



23. Use CA to fix the rudder.



26. Use a hobby knife to cut a small slot on the elevator so that can install the control horn easily.



24. Insert the elevator servo into the servo hole , Glue the servo .



25. And fix the servos onto the plywood servo mount with included screws.



27. Connect the elevator and rudder horn onto the Z bend.



28. Through the other side of the Z bend to the hole of pushrod connector , and then insert the rudder and elevator horn into the pre-cut slot.



29. Glue the control horn





30. Use screwdriver to tighten the pushrod connector with the screws.

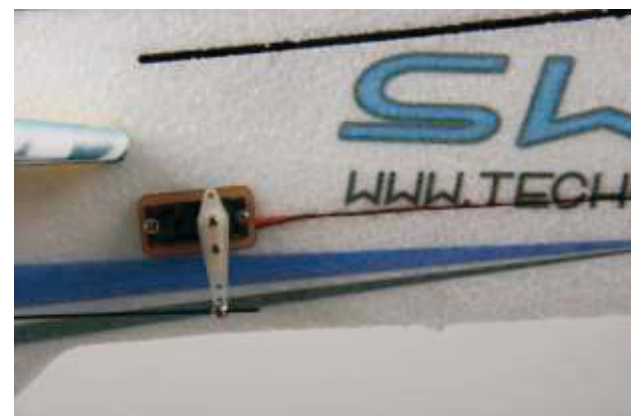

33. Embed the rudder and elevator servo leads into the pre-cut slots on two sides of fuselage. Pls use the servo extension wire if the servo wire is not long enough.



31. Use the pinchers to cut off the superfluous steel wire.

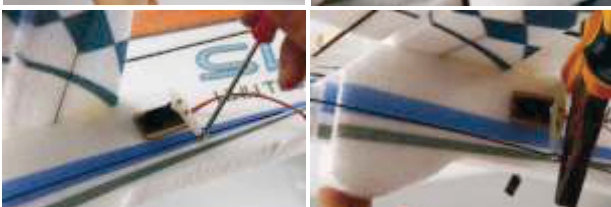
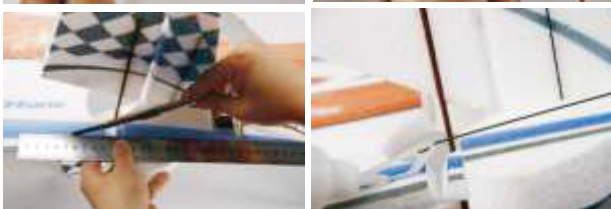

32. Use the same method of installing the elevator pushrod to install the rudder pushrod.



34. Connect the horizontal stabilizer to the bottom of the fuselage by using 2pcs 1.3\*230mm stab brace carbon rods, and then reinforce the rods by using CA, pls make sure the Horizontal Stab is vertical the fuselage when you connect.



35. Insert the landing gear port into the slot of plywood mounting brace onto the bottom of the fuselage.



36. Use included screws to fix the motor onto the motor mount.

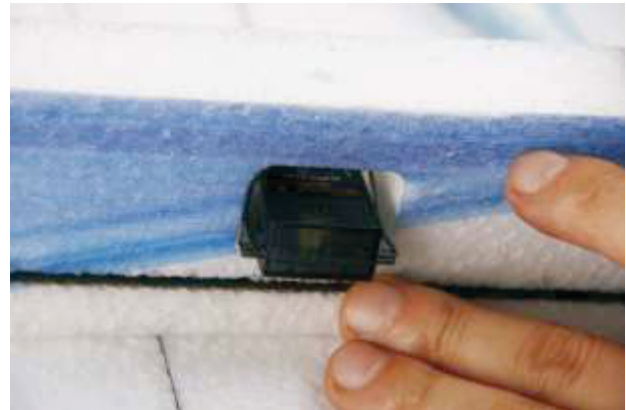

40. After test, put the receiver into the receiver slot. (see picture)



37. Connect motor and ESC, then adjust to correct motor running direction before flying. Put ESC into the slot of downside fuselage.



41. fix the propeller



38. Insert battery into the battery hole.



A perfect SWIFT 3D-EPP is done after your careful assembly. While assembly, the flying weight is really critical to the flight performance and will be affected by adding weight, so you should reduce any unnecessary weight while assembly. Then you'll get the best flying performance.



39. Link the servo leads and ESC to receiver, then test.