

Stinger 64

64mm Sport Jet

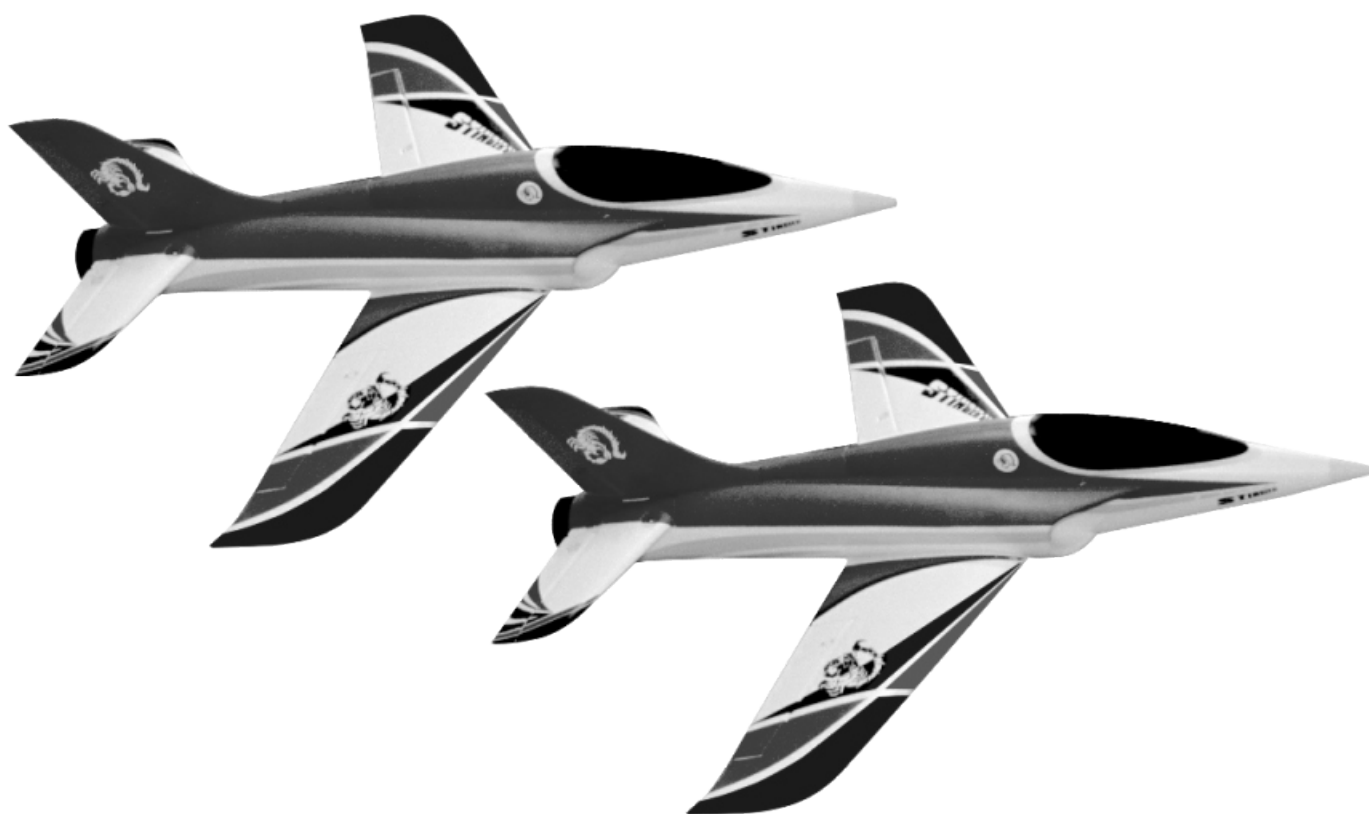

User Manual

- *The manual suit for every color scheme of Freewing Sport Jet Stinger 64.*
- *The manual only choose one color scheme as an example.*

Thank you for your purchase of our Freewing Stinger 64 sport jet.,it uses high-intensity EPO foam material. Every components are free to disassembly and assembly. Removable landing gear, could take-off and landing in any site. At the same time, its great power, will give you incredible speed pleasure.

As all of our models,we provide four different configurations to choose: RTF,ARF,PNP,Airframe only. Contents list is as follows:

(RTF ○ ARF ■ PNP ▲ Airframe only ●)			
Pre-painted fuselage set	▲■○	3S 1600mAh 20C Li-poly Battery	■○
Landing gear set	●▲■○	9g servo*5pcs	▲■○
Nose cone	●▲■○	64mm EDF Fans	●▲■○
Y-wire	●▲■○	2.4G 4CH Transmitter and 6CH Receiver	○
USE Manual	●▲■○	Screw accessories package	●▲■○
2627-4300KV Brushless Motor	▲■○	Li-Poly Charger	○
30A ESC	▲■○		



Main Specifications

- Wingspan:700mm (27-9/16")
- Fuselage length:800mm (30-1/2")
- Flight weight:540g (18.99 oz.)
- 64mm Ducted Fan

Safety Statement

- 1.This is not a toy.It is for experienced modelers only.You are responsible for the safeoperation of this model and any damage of harm it may cause.
- 2.Before flying the 64mm Sport Jet Stinger for the first time .Please read through the instructions carefully and make sure that your radio equipment is working properly and has been range testedprior to flight.
- 3.Young people under the age of 14 should only be permitted to operate this model under the instruction and supervision of and adult with modeling experience.
- 4.Please keep these instructions for future reference after completing model assembly.Theycontain information critical to the safe operation of this model.
- 5.If you have any further questions regarding the safe operation of you RC model.pleasecontact your local hobby shop. flying club or Freewing Model for professional help and advise.

Assemble

Stinger64 sport jet is very easy to assemble, it only need 30 minutes to complete the assemble. Before starting, please read the instructions carefully.



1. Connect the left/right main wing servo wire by Y-wire.

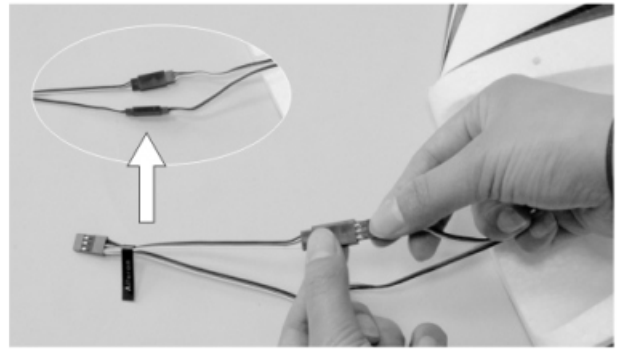

2. Reverse the fuselage and tear off the tape which fix the ducted fan.

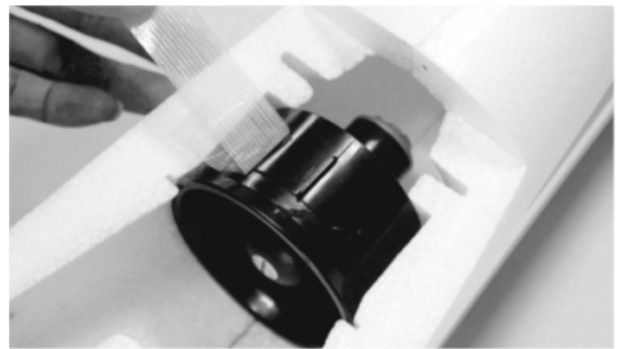

3. Install the main wing on the fuselage and fix by screws.

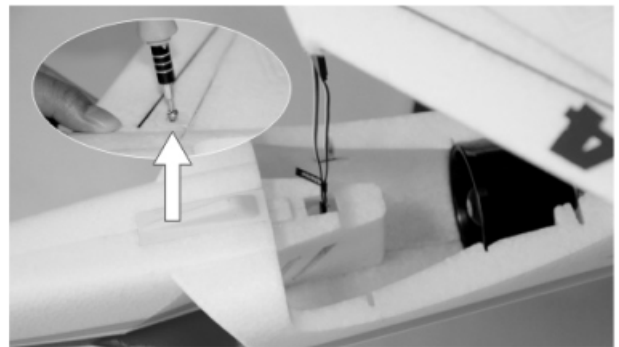

4. Install tail wing set.



5.Lock the rudder on the elevator by screws

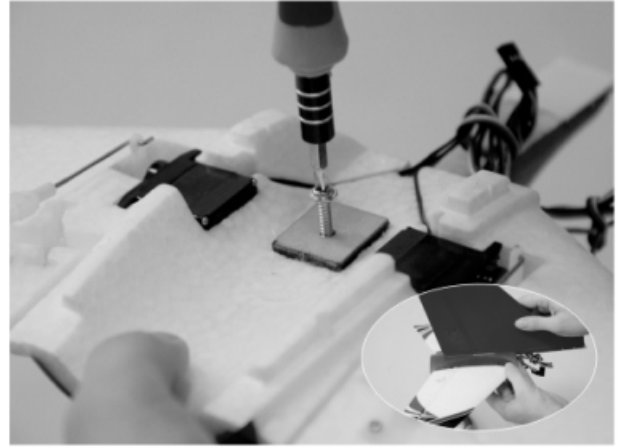

6.Insert the rudder into the trough position as the photo shown.

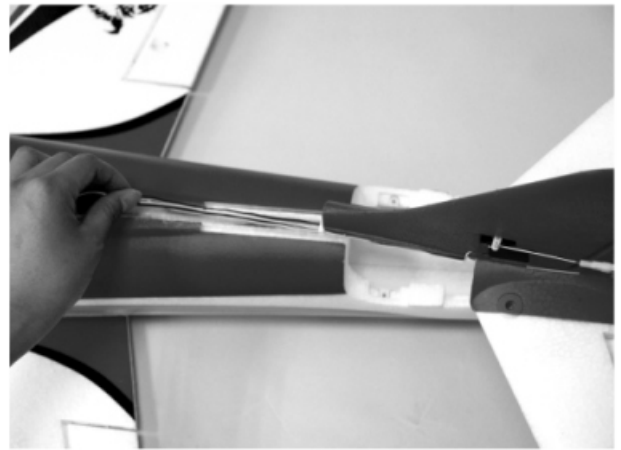

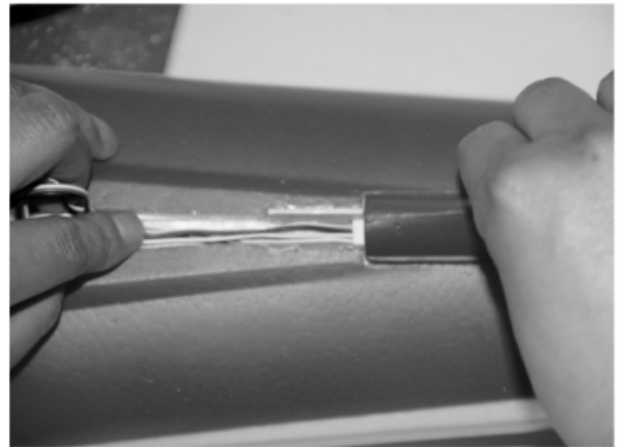

7.Insert the rudder servo wire and elevator servo wire into fuselage through the trough.



8.Fix the tail wing by screws.

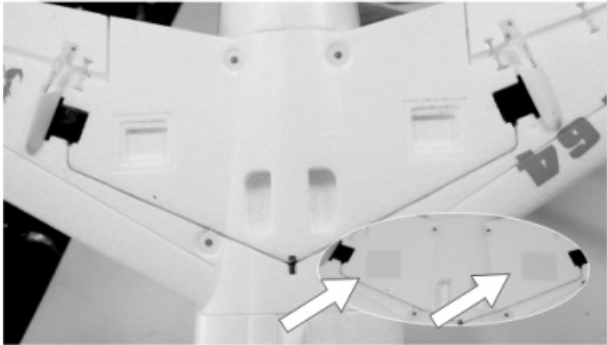

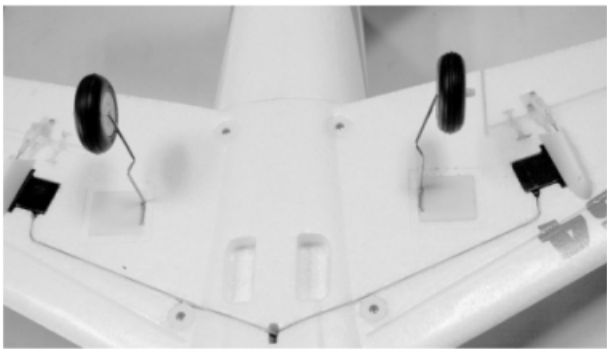
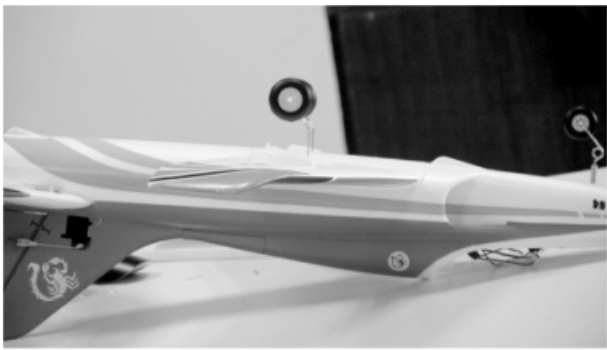
<p>10.If you need take off from the ground and also purchased our landing gear spareparts, you could install the landing gear according to the following:</p>	
<p>11.The landing gear install position covered with plastic parts and tapes before Stinger64 leave the factory. At first, we need to remove the plastic parts and tapes.</p>	
<p>12.Stick the nose landing gear by glue to this position as the right photo shown. Before stick, please insert the nose landing gear servo wire into the battery compartment.</p>	
<p>13.At last, Fix the left/right landing gear by glue.</p>	
<p>14.Refer to the right photo, pay attention of landing gear direction.</p>	

Adjustment

1, Connect the servo wires on the receiver.

Attention: some servo wire maybe need pull out by forceps.



2, Stick the velcro on the side of battery in order to fix battery, and put it into the cockpit.



3, Switch on the transmitter, connect the battery and ESC. Check all the servo is the middle.

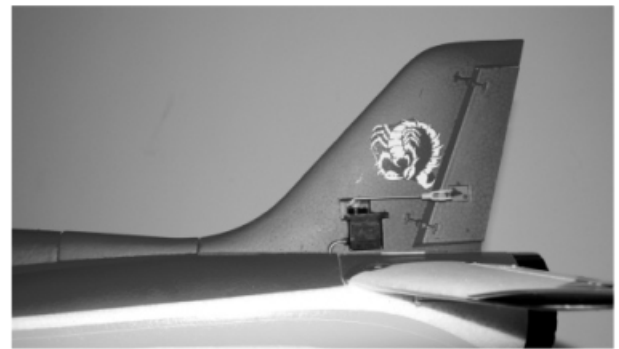

4, Keep the servo control surface to the same level with the wing face, then fix the clevis on the servo arm, At the same time, put on silicone tube in order to prevent clevis loss.

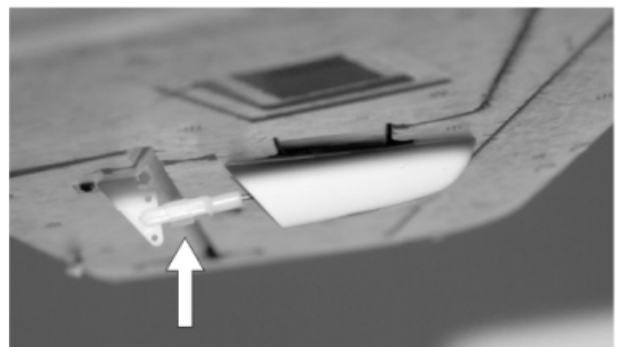

5. The CG Range is 60mm-70mm from the front of the wing where it meets the fuselage, Adjust your battery location so that your center of gravity is within this range.

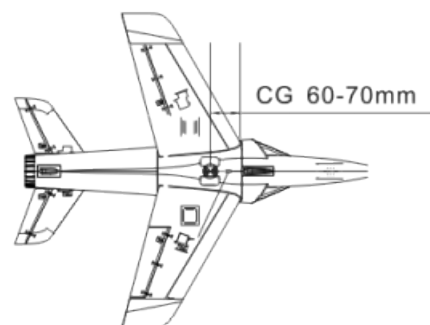

Preflight

1. Aircraft assembled correctly and ready for flight.
2. All control throws are set per this manual.
3. Transmitter fully charged and on the correct model.
4. Aircraft balances at the recommended CG location.
5. Flight batteries are fully charged and secure.
6. All controls are operating correctly, in the proper direction, and are secure.
7. Complete a radio range check per your radios manual.
8. Wait for a calm or light wind day for first flights.

More introduction of "airframe only" assemble

1. "airframe only" accessories package have two servo install box, use for fixing the servo. It could replace the servo very convenience and don't damage the foam. But, some servo size maybe don't suit for, we advise you choose suitable servo or stick the servo on the foam directly.

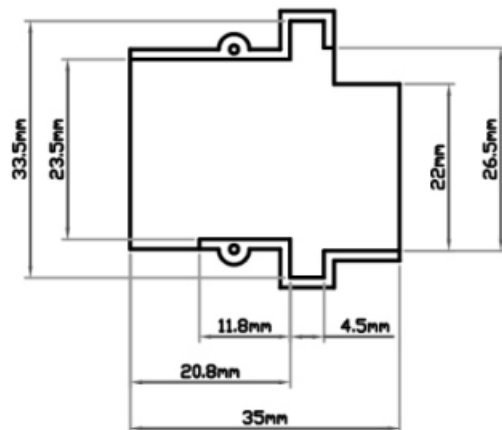
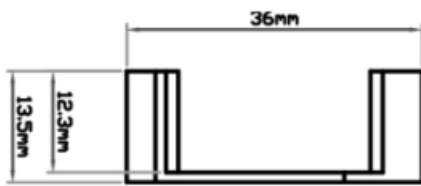

2. We also provide the landing gear set, so, please refer to the following size to choose servos for convenience to install.

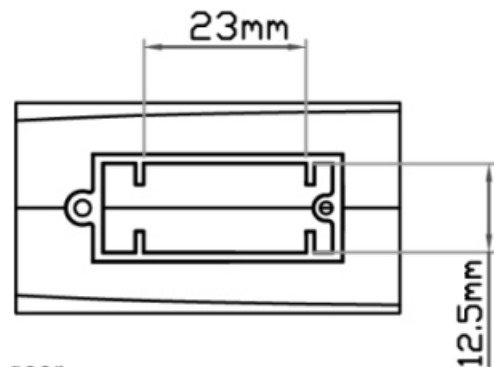
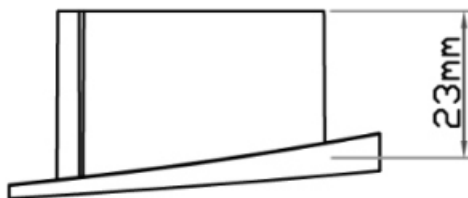

3. Please refer to the following photo to install the nose landing gear.



Nose Landing Plastic Strut



Screw PA2.0*8 1pcs



Nose Landing Steering Arm



Screw PA1.7*4 1pcs



Nose Landing Wire (upper)



Wire Connect Column

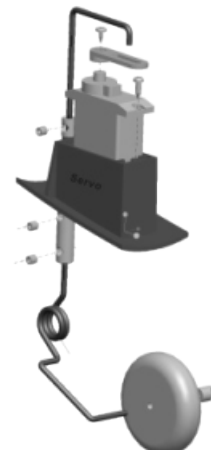

Nose Landing Wire (lower)



Screw M3*3 3pcs

Operating instruction of Radio Control

1. Radio control include the transmitter and receiver.



2. Radio control function introduction.

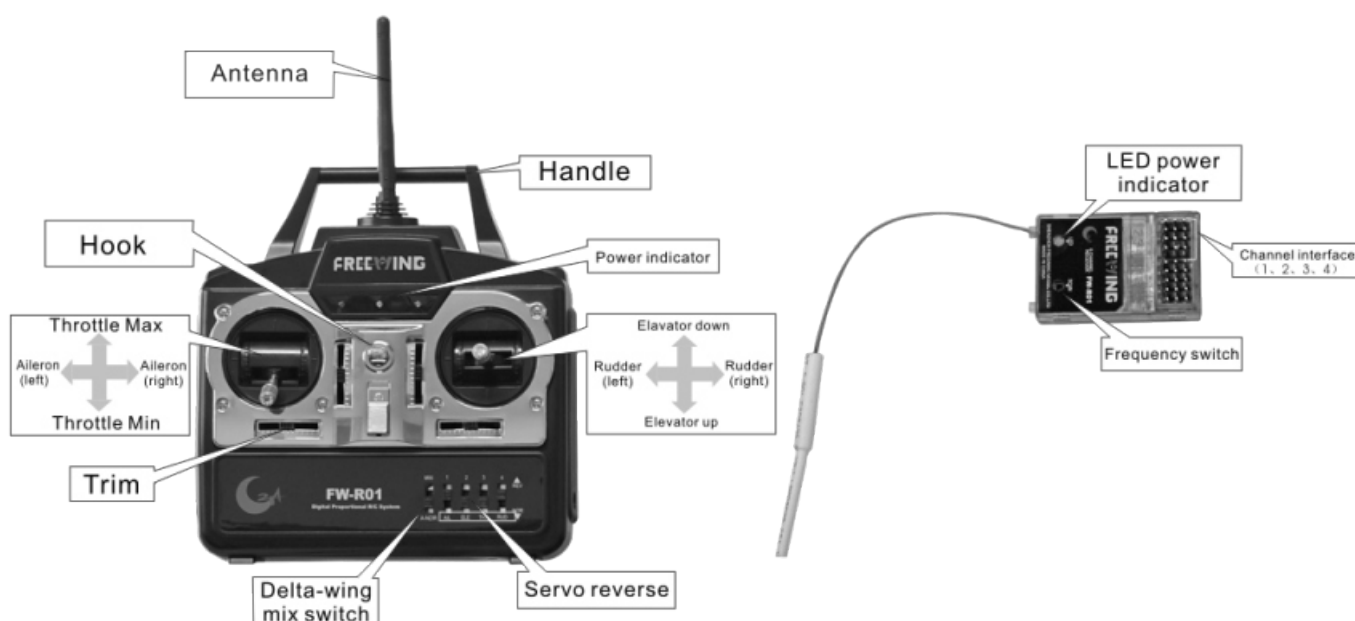

3.2.4G Radio control frequency method.

Note: the radio control has been established on the frequency treatment in factory, could use directly. In exceptional case, it need re-adjust frequency, please set as following:

- Press on the receiver frequency switch,
- While press on the receiver frequency switch, the receiver power on.
(Now, the receiver frequency signal light should be continue flashing.)
- Turn on the transmitter power switch
(Now, in transmitter panel, red light, yellow light, green light will be continue flashing)
- Stop to press on the receiver frequency switch
- After the success of the frequency, the receiver frequency signal light is on, not flashing.
The transmitter signal light is on, not flashing, it transformed to battery signal light

Sparepart list

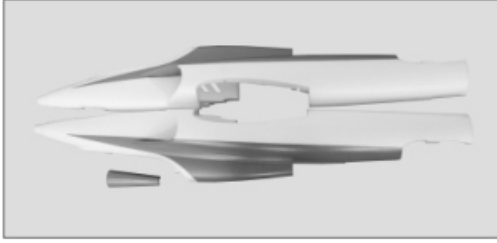

Item No.: F270104
Fuselage



Item No.: F270103
Main Wing Set

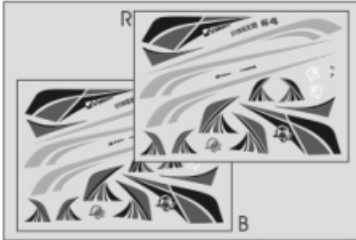

Item No.: F270107
Sticker



Item No.: F270106
Nose Cone

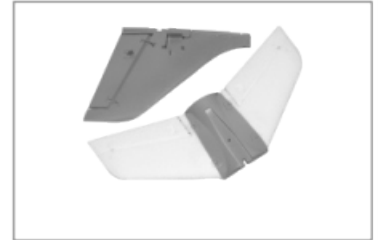

Item No.: F270102
Tail Wing Set



Item No.: F90132
26274300kv Motor

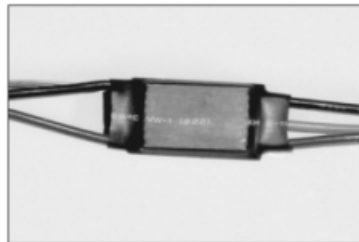

Item No.: 55052
30A ESC



Item No.: 3026
9g Servo



Item No.: F3028
Li-poly Battery
1600mAh 20C 3S(11.1v)



Item No.: F90210
64mm Ducted Fan



Item No.: F270108
Landing Gear Set

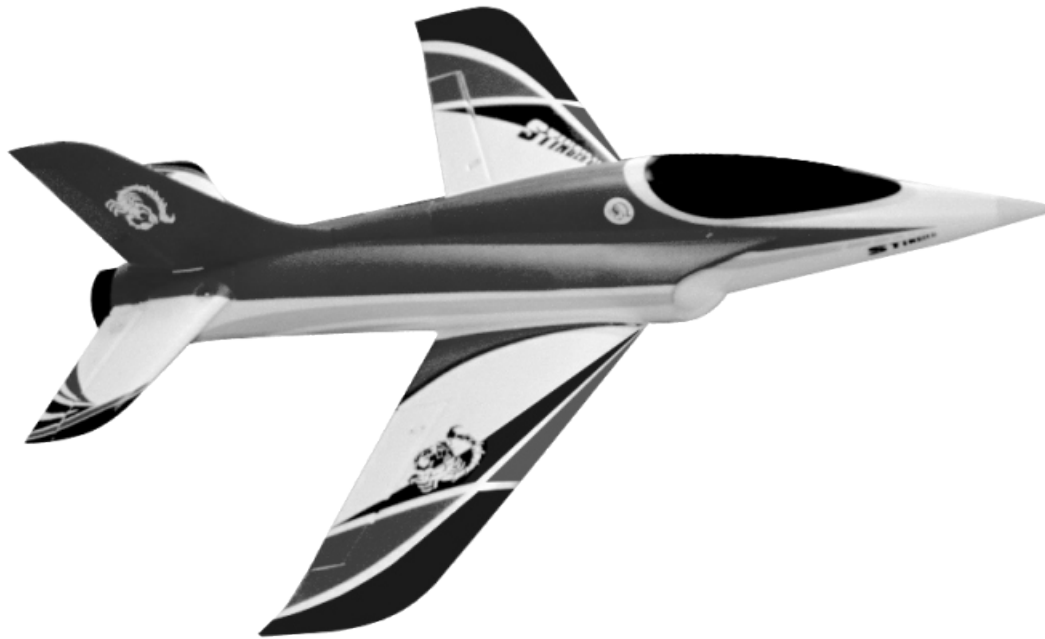

Have Fun!
We hope that you have many pleasant
flights with your Stinger 64



Shenzhen Freewing Model Co., Ltd
HK Freewing Model International Limited

Add.: East2/F, No.5 Blog. Donglongxing Industry Zone. Huaning Road. Dalang
Longhua Town, Bao'an, Shenzhen city, China.

Web: <http://www.sz-freewing.com>

Email: freewing@sz-freewing.com

Tel: 86-755-29671969 Fax: 86-755-33231843