

BANCROFT

14+
THIS IS NOT
A TOY

FOCUS V3

1000mm 2.4GHz RTR RACING YACHT



SPECIFICATION:

- Total Length: 995 mm
- Mast Height: 1578 mm
- RTR Total Weight: 2930 g
- Sail Area(Main): 3420 cm²
- Hull Material: Plastic Hull With Painting Finished
- Mast And Boom Material: Carbon Fiber Tube
- Width: 170 mm
- Overall Height: 2046 mm
- Sail Area(Jib): 2128 cm²
- Sail Area(Overall): 5548 cm²

Assembly and Operation Manual

INSTRUCTION MANUAL **THIS MODEL IS NOT A TOY!**

THESE INSTRUCTIONS SHOULD BE READ BY A SUPERVISING ADULT



















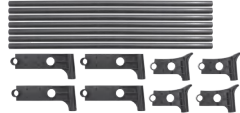







FOCUS V3 2.4GHz RTR RACING YACHT

SKU # BNC1047-002, BNC1047-003

IMPORTANT:

1. This is not a toy. Assembly and operating of this boat requires adult supervision.
2. Please take time to read the instructions carefully and completely before attempting to operate your model.
This manual contains the instructions you need to safely build, operate and maintain your R/C sailboat.
3. Please do remember to switch off MXMD button on transmitter before operation. (Switch Off position on top)

CONTENTS OF KITS

				
Hull with winch servo, rudder servo, battery box & receiver pre-installed	2.4GHz 4CH Transmitter	Jib Sail & Main Sail		
				
Long mast	Jib boom	Mast fitting tube		
				
Short mast	Main boom			
				
Carbon backstay crane	Display Stand sets	EVA for display stand	Bolts for display stand	
				
Rudder	Rudder arm	Mast fitting mount	Mast fitting metal ring	Keel Nuts
				
ABS keel Zinc Alloy Ballast	Rubber ring	Spare rubber band	Cord clip	Mainsail luff rings
				
Dyneema cord	Deck Cloth patch 2pcs	10 pcs Bowsie	2.5mm & 1.5mm Allen key	Stand laydown upgrade kits

ITEMS REQUIRED FOR COMPLETION

Eight "AA" Alkaline batteries. (four for the transmitter, four for the receiver battery box.)

BASIC BOAT TERMINOLOGY

BOW: The front of the boat.

STERN: The back of the boat.

PORT: This is the left side of the boat when view the boat from the stern. An easy way to remember this is that port and left both contain four letters.

STARBOARD: This is the right side of the boat when view the boat from the stern.

HULL: The body of the boat.

DECK: The top of the boat.

KEEL: A weighted blade that protrudes from the bottom of the hull as a means of providing lateral stability.

RUDDER: The hinged vertical plate mounted at the stern that controls steering.

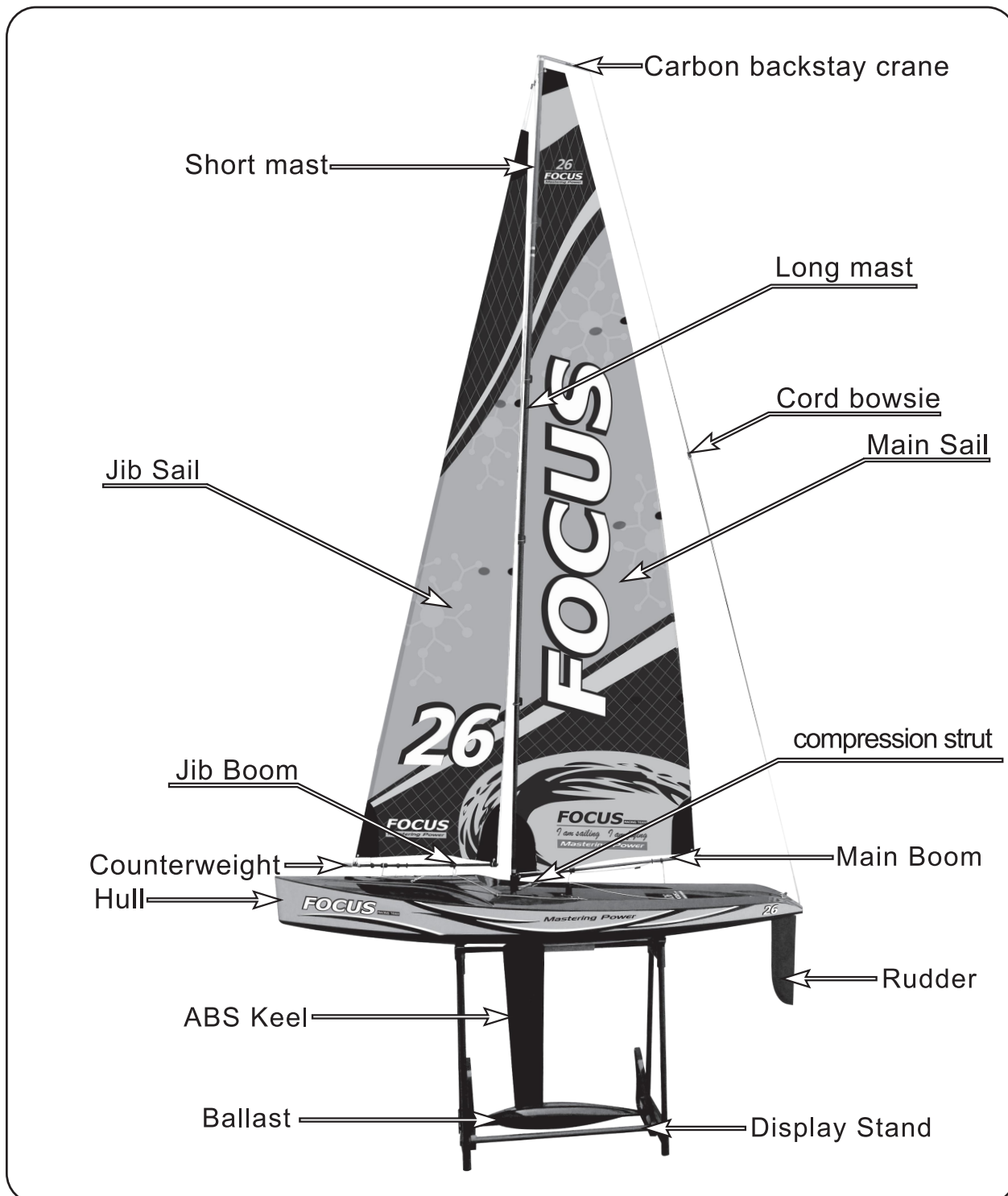

DISPLAY STAND ASSEMBLY

- 1 Identify all stand components from box.
- 2 Bolt the plastic moulded components together with the twelve nut & bolts supplied.
- 3 Construct the leg sections. *Note: All leg and stretcher tubes are of equal length.*
- 4 Fit the Stand Upgrade Kit items on to the stretcher tubes as shown, then fit the stretcher tubes in to the leg sections.
- 5 Fix the soft EVA foam supports to the top surface of the stand and Upgrade Kit sections to protect the Hull from scratches.



The Stand Upgrade Kit allows the boat to be placed on the stand in the upright position for easy access when rigging and indoor storage (shown above left), or the stand can be laid on its side and the boat secured in an almost horizontal position (shown above right) for additional stability outdoors.

KEEL & BALLAST & RUDDER ASSEMBLY

1. Secure keel and ballast with M6 nut and flat-head screwdriver.
2. Assemble the rubber ring on top of keel, Adjust the Sliding Deck Plate to align with the center graduation as shown below. Tighten keel and hull with metal ring, M6 nut and flathead screwdriver.

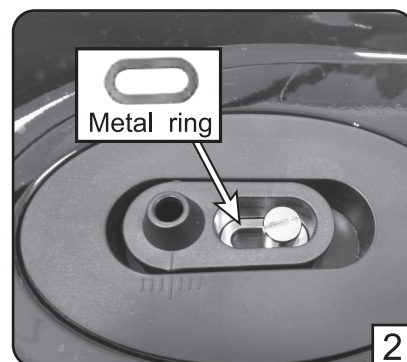
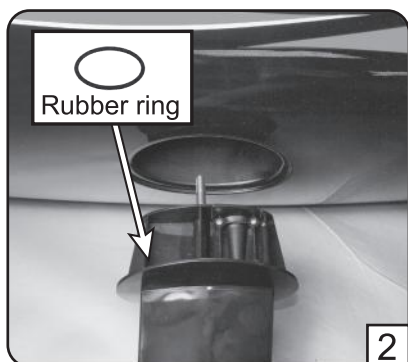

3. Insert the rudder shaft up through the bottom of the stern of hull. Notice the rudder's direction. Use 2.5mm allen key to secure the rudder shaft on the rudder arm. Make sure rudder can freely rotate and the gap for up and down is no more than 0.5mm
4. Pushrod go through clevis on rudder arm, make sure rudder is on the center line of hull, then use 2.5mm allen key to tighten clevis screw.

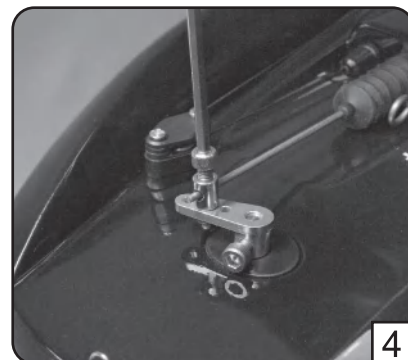
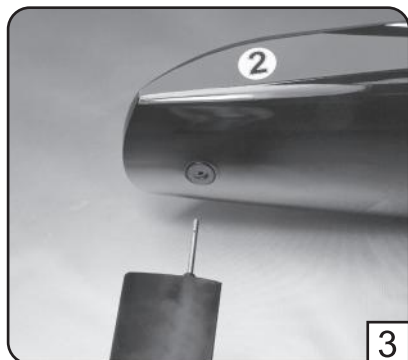

MAIN SAIL RIGGING

1. Use mast fitting tube (longer side) to thread through bearing on main boom, insert mast fitting tube in main mast mount as shown. See page 6.
2. Insert long mast in mast fitting tube (shorter side). See page 6.
3. Thread three mainsail luff rings through long mast and thread the top one mainsail luff rings through short mast, See page 6.
4. Assembly Carbon backstay crane set and insert it into short mast, See page 6.
5. Insert short mast into long mast with mast fitting tube. Cut a length of Dyneema cord at around 2300mm, attach it to Carbon backstay crane eyelet, the other end of cord thread through a bowsie's two holes in proper order, through stern eyelet then attach cord to the end eyelet of bowsie. adjust cord bowsie to pull cord tight and straight, See page 6.
6. Cut a length of Dyneema cord at around 150mm, use it to attach eyelet on mainsail tip, cord thread through carbon backstay crane left second hole, through a bowsie's two holes in proper order, through the crane third and fourth hole in proper order, then tight a knot on the third hole on bowsie. Tighten the bowsie. Notice that gap between mainsail tip and Carbon backstay crane is within 6mm-10mm, See page 6
7. Adjust silicone rings ("SR" for short) positions on main boom as shown.
8. Cut a length of Dyneema cord at around 250mm, attach it to eyelet located on the top of main boom bearing, the other end of cord thread through eyelet in bottom left corner of mainsail from front side to back side, then through eyelet on bottom of main boom bearing from back side to front side, then thread through a bowsie's two hole in proper order, through the compression strut fitting eyelet, at last attach cord to the end eyelet of bowsie, adjust bowsie to pull main sail tight.
9. Use metal sail crew ring between SR2 and SR 3, to hook the eyelet on bottom right corner of mainsail, the two rings are used to clamp metal sail crew ring to prevent it sliding, you could adjust the mainsail shape by moving the two rings position. Use hand to rotate the brass compression strut to adjust the angle between main boom and mast. After getting the angle you want, screw the nut tighten to secure firmly the brass compression strut. So that the main boom could pull the bottom right corner of mainsail tight. But remember not to pull mainsail too tight. See page 6.

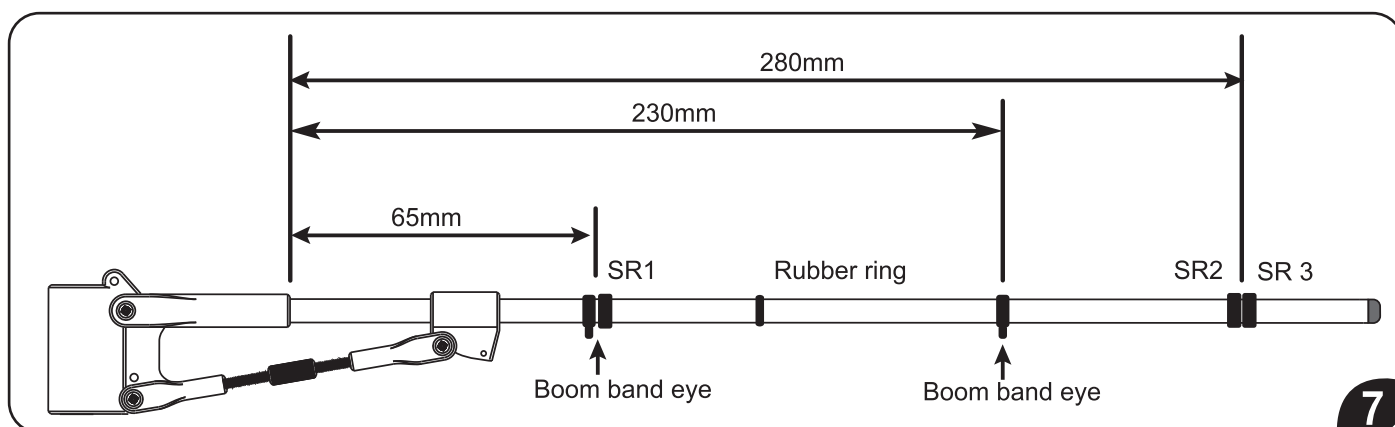

MAIN SAIL RIGGING

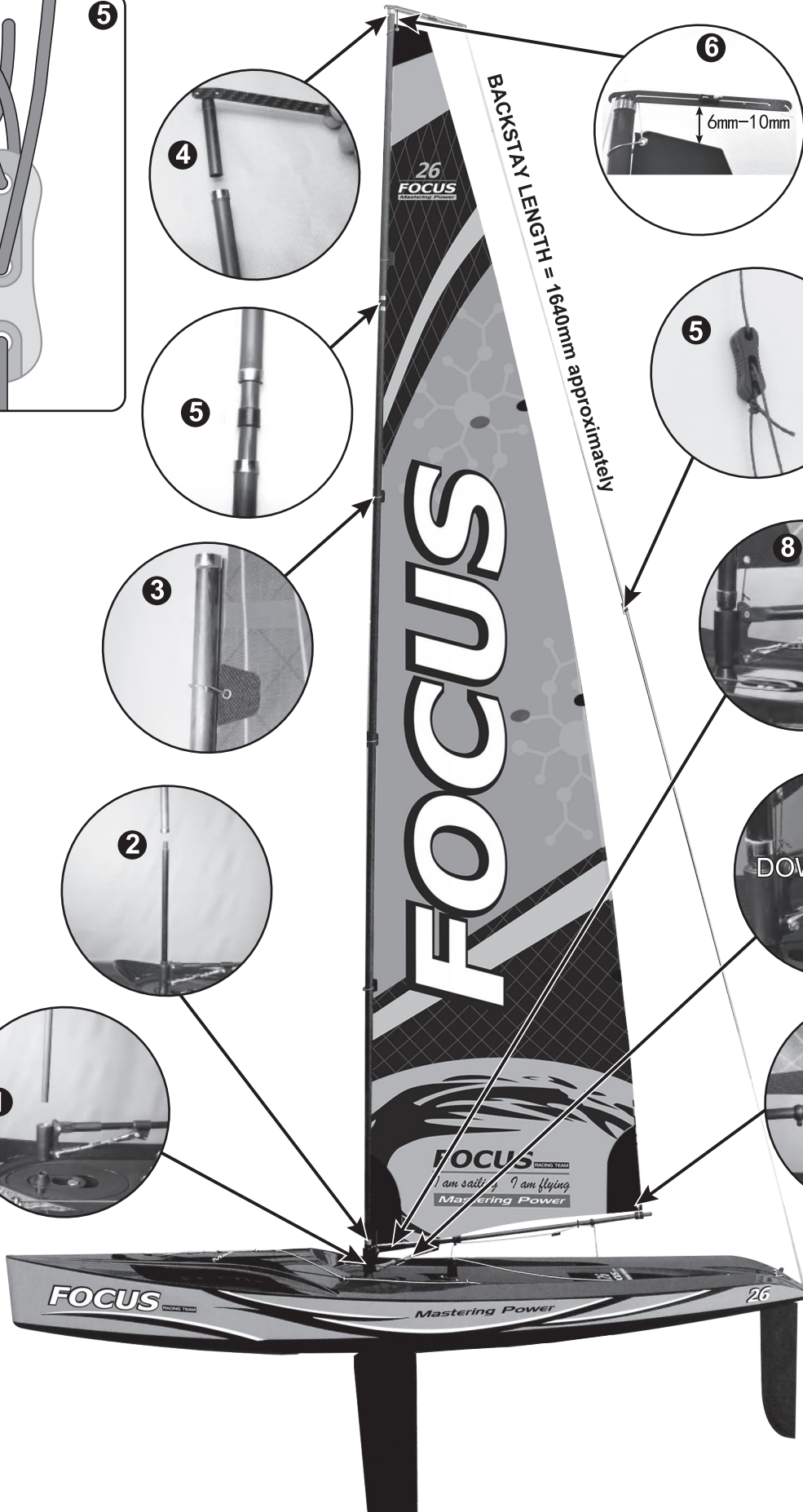
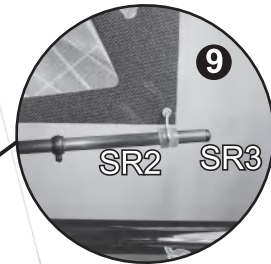
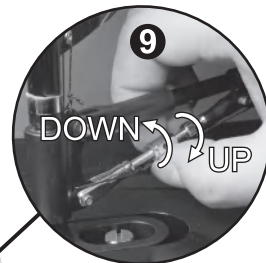
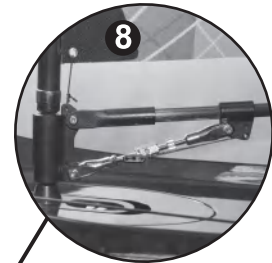
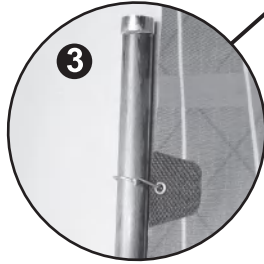
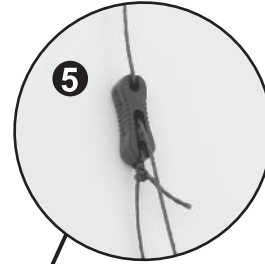
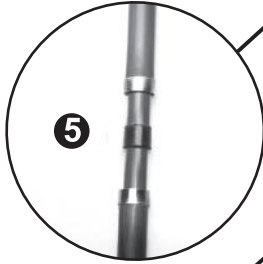
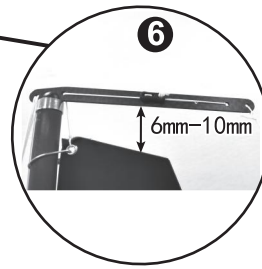
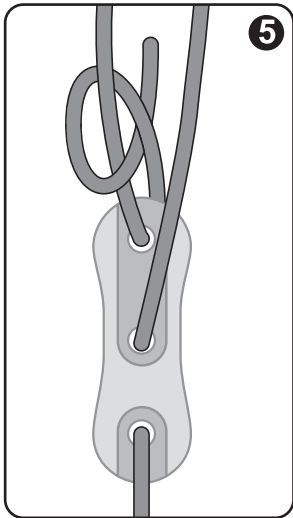

JIB SAIL RIGGING

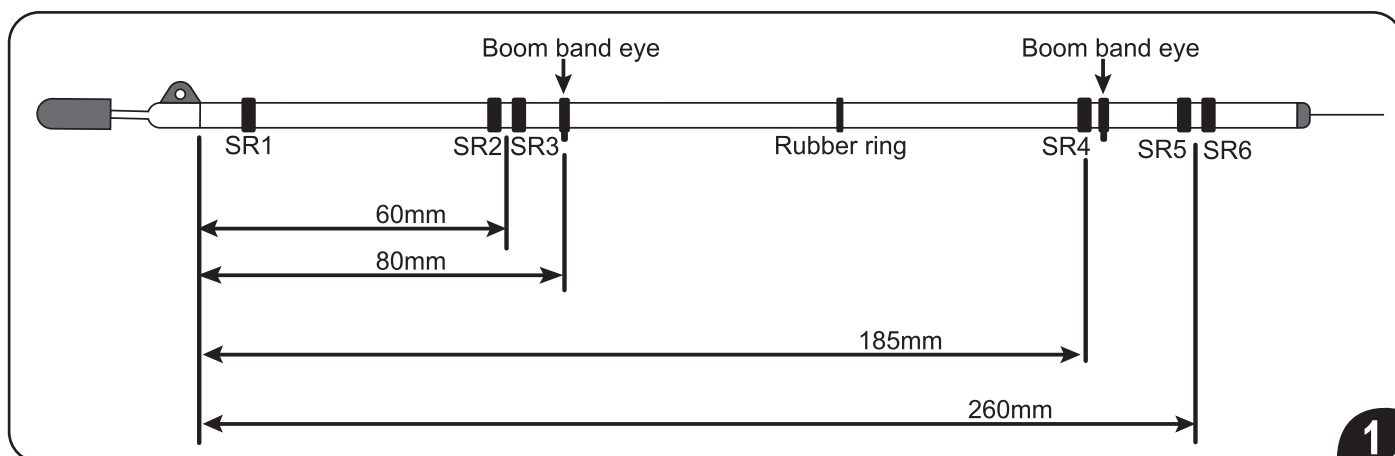

1. Adjust silicone rings ("SR" for short) positions on jib boom as shown.
2. Use forestay cord on the bottom left corner of jib sail to thread through the first hole, then tie a knot on the jib weight shaft. Cut a length of Dyneema cord at around 100mm, attach it to eyelet in bottom left corner of jib sail, the other end of cord thread through 2nd eyelet in jib boom front end fitting from back side to front side. attach cord to silicone ring "SR1" on jib boom. Adjust SR1 position to adjust jib sail distance from jim boom. to make sure jib sail is 3mm-5mm top above jib boom.
3. Use metal sail crew ring between SR5 and SR 6, to hook the eyelet on bottom right corner of mainsail, the two rings are used to clamp metal sail crew ring to prevent it sliding, you could adjust the jib sail shape by moving the two rings position.
4. Use forestay cord on jib sail tip to thread through a bowsie's two holes in proper order, then through first hole on the backstay crane, attach cord to end eyelet of bowsie (Tips: ensure bowsie is closer to crane for easy adjustment).
5. Cut a length of Dyneema cord at around 300mm, attach it to eyelet in jib sail tip, the other end of cord thread through a bowsie's two holes in proper order, then through first hole on the backstay crane, attach cord to end eyelet of bowsie . (Tips: ensure bowsie is closer to crane for easy adjustment). This cord is Jib Sail Lifting.
6. Use jib boom lifting cord to thread through a bowsie's two holes in proper order, then through first hole on the backstay crane, attach cord to end eyelet of bowsie.
7. Cut a length of Dyneema cord at around 250mm, attach it to jib boom tube between "SR2" and "SR3", the other end of cord is threaded through Deck Eyes 2 & 3, then tie a loop, loop around the Deck Eye 4 (Deck Eye 4 is already converted into a hook). This arrangement allows rigs to be changed quickly and easily with no necessary of bowsie adjustment. Now adjust three cord bowsies (Forestay cord, Jib Sail Lifting cord and Jib Boom Lifting cord) tight, so to make sure Jib Boom is 15mm-20mm top above deck level. Then adjust SR2, SR3's position on jib boom to pull jib boom, ensure jib boom end is around 5mm distance to mast.

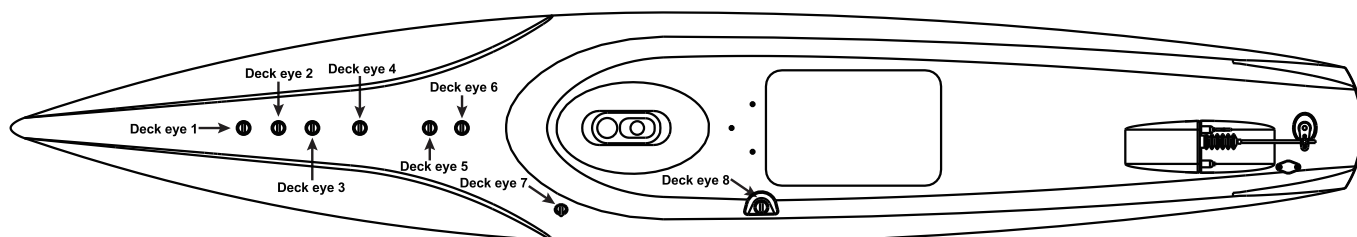

JIB SAIL RIGGING

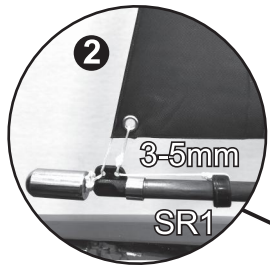
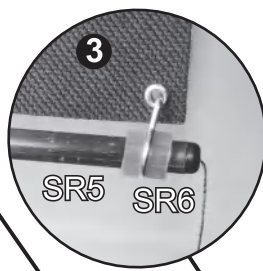
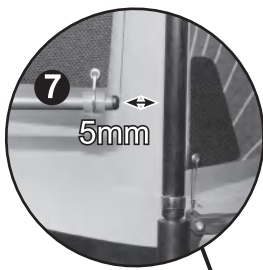
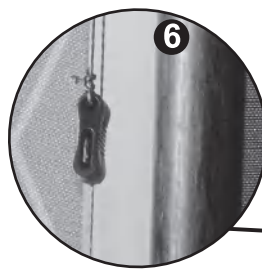
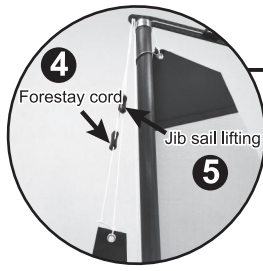
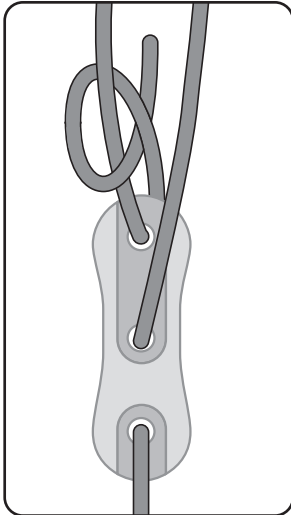

Backstay crane

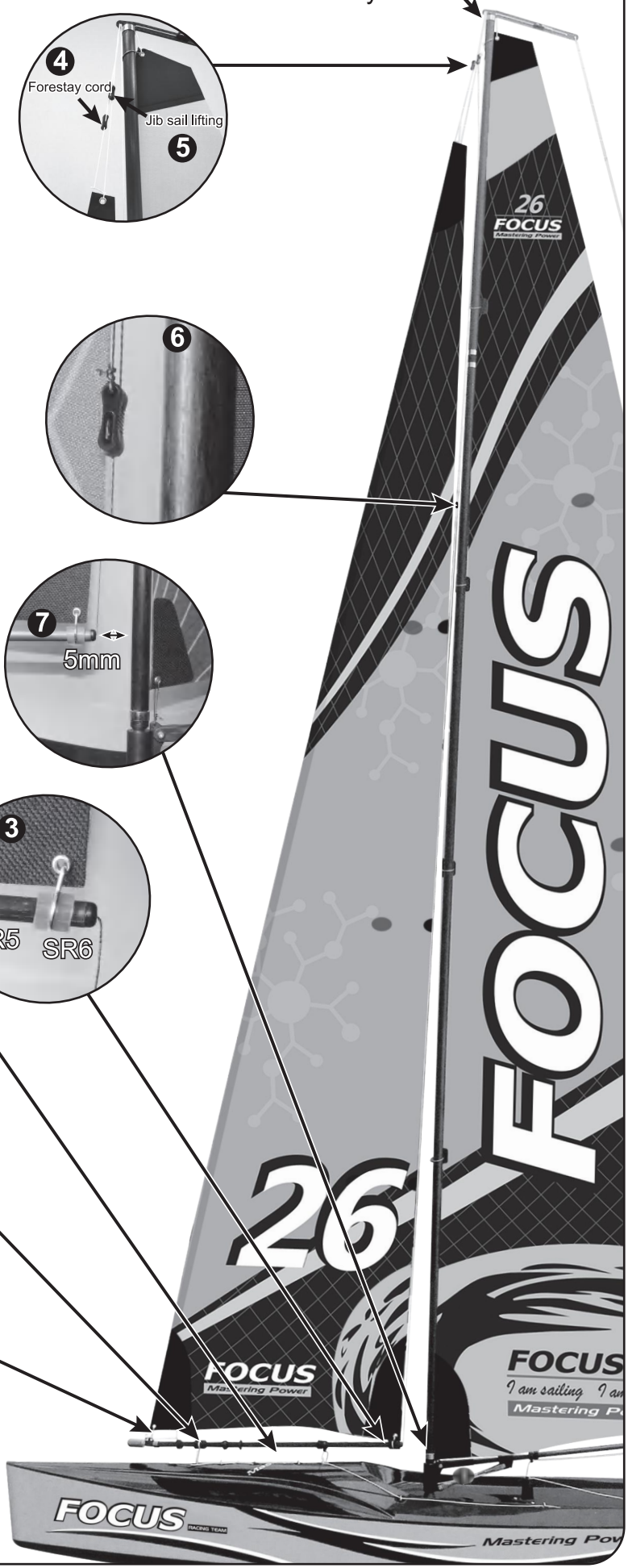

MAST, JIB SAIL, MAIN SAIL ADJUSTMENT

1. Mast sliding mount is combined with fin box pre-set in factory as photo shown. This setting will ensure backstay length around 1640mm for a standard rig setup when backstay and forestay cord are pulled tighten. If mast sliding mount is not pre-set like this, you could use flathead screwdriver to loose mast sliding mount screw and move mast sliding mount forward or backward.
2. Adjust bakstay cord bowsie and forestay cord bowsie to pull these two cord tension.
3. Adjust bowsie located in compression strut and rotate brass compression strut to pull mainsail tight after the above rig has been setup. Adjust SR1 position on Jib Boom, Jib Sail Lifting cord bowsie to pull Jib Sail tight. Remember not to pull mainsail and Jib Sail too tight.
4. Normally, in strong wind, move SR2 and SR3 position to right side on Main Boom, move SR5 and SR6 position to right side on Jib Boom, so these setting can adjust the mainsail and jib sail's radian smaller. In light wind, move these rings' position to left side on Main boom and Jib boom, so these setting can adjust the sails' radian bigger. You need to learn youself in sailing to master the settings base on different wind power.

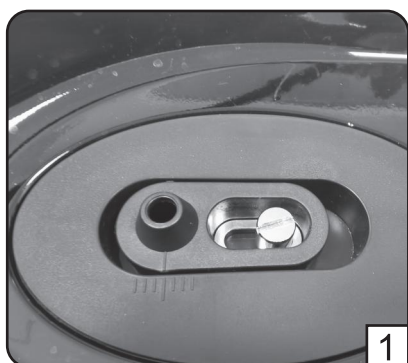

MAIN BOOM & JIB BOOM RIGGING



1. Slide off the battery door on the back of the transmitter. Install 4 fresh "AA" alkaline batteries into the transmitter in the configuration molded into the battery compartment. Re-install the battery door onto the back of the transmitter.
2. Push down the throttle stick (Left Stick, MODE 2) till the end as shown. Switch off "MXMD" button on top position, because Focus II sailboat doesn't need mix control function. Then turn on the transmitter by pressing on the power switch.
3. Take the battery box for receiver out from the servo plastic tray inside the hull, install 4 fresh "AA" alkaline batteries into the battery box. Switching the power button on, to check whether the receiver are binded already with transmitter or not. If not, see the following pages of TRANSMITTER/RECEIVER BINDING for reference. Replace the battery box on the servo plastic tray and use rubber band to tie battery box securely on place as shown.

REMARK: If reciver have already been binded with transmitter, the rudder servo will automatically return to neutral position, if rudder servo is still not in the neutral position, adjust the rudder neutral trim, see following pages for reference.

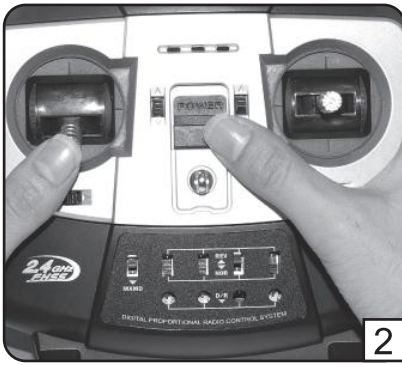

2

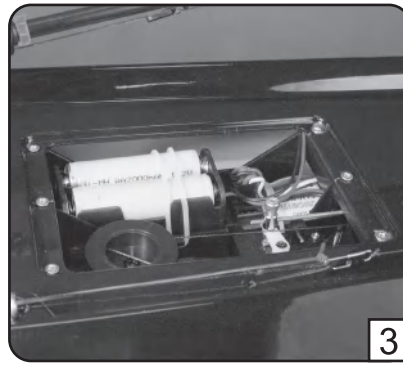

3

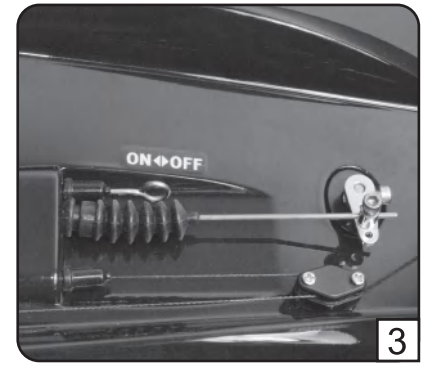

3

4. Now sail control stick (left stick) push down till the end, the sail winch servo pull cord tight. Pull out Switch rod to switch off receiver and switch off transmitter. Note: if sail control stick (left stick) push down, the sail winch servo loose cord, then you need to move the sail servo reverse switch (CH3) to the other position
5. Cut a length of Dyneema cord at around 650mm, tie a loop, and hook it on the clip as shown, the other end of cord thread through deck eye 8 and mainsheet deck eye as belowing marked, then through boom bend eye and through bowsie's two holes in proper order (tips: bowsie closer to boom end eye for easy adjustment), then through the rubber ring and the other boom band eye, then attach it to one end eyelet of bowsie, Make sure main boom is pulled as on the centerline of hull. If not, adjust bowsie to pull main boom tight.

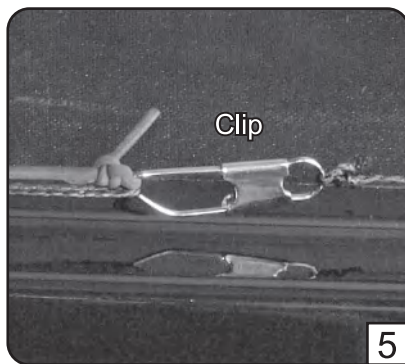
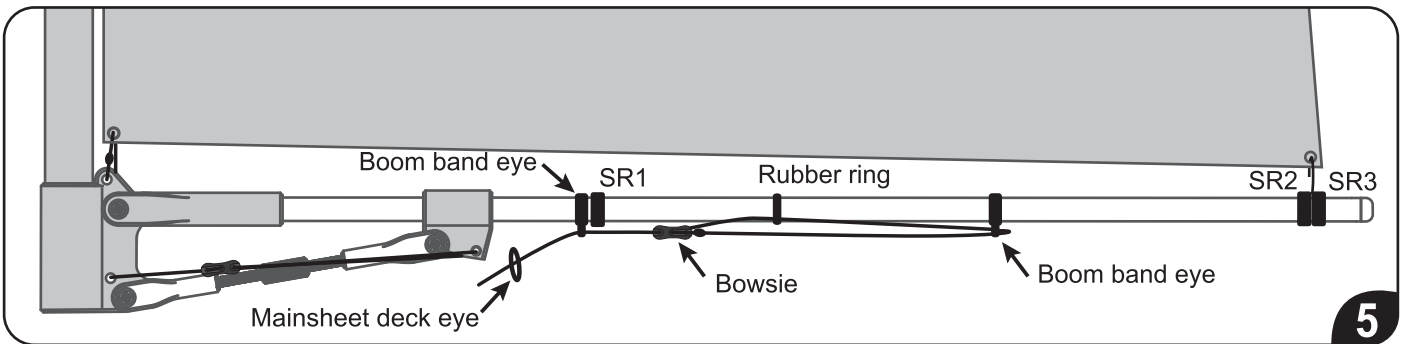

5

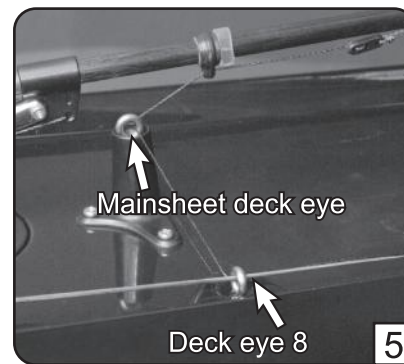

5

6. Cut a length of Dyneema cord at around 700mm, tie a loop, and hook it on the clip as shown, the other end of cord thread through deck eye 8, 7 and 6, then through boom band eye on jib boom between SR4 and SR5, then through rubber ring as shown and through bowsie's two holes in proper order (tips: bowsie closer to boom end eye for easy adjustment), then through another boom band eye, attach it to one end eyelet of bowsie. Adjust bowsie, push jib boom away on either port or starboard, to make sure rear-end of Jib boom is moved away from mast at 30mm-35mm.

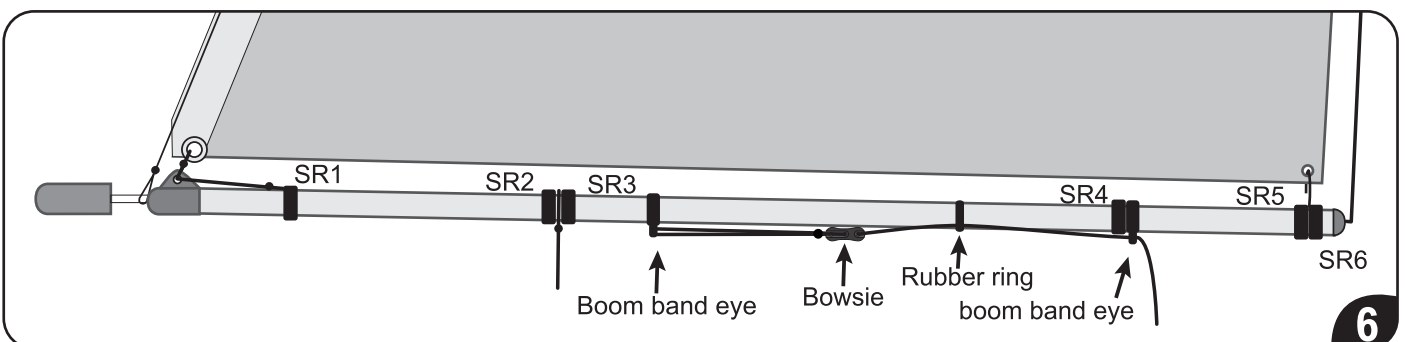

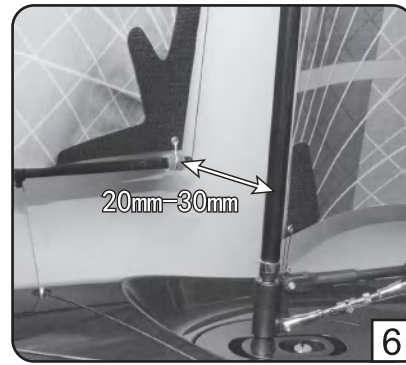
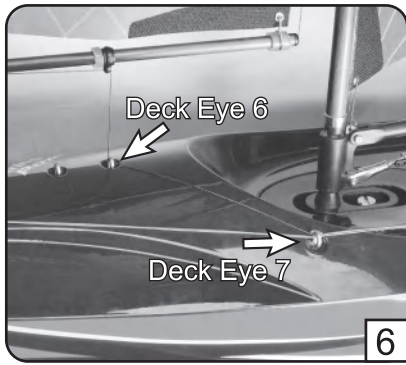

7. Switch on transmitter and push in Switch rod on deck. If transmitter power indicator light flash, push up throttle stick till the top end, then push down till the lowest end again, transmitter power indicator light should be solid on, now transmitter is activated. Push up sail control stick(Left stick), sail winch servo will loose all cord out, move Mainsail and Jibsail away till the maximum angle, to make sure Mainsail could travel about 80° , Jibsail could travel about 80° , if not, adjust boom band eye and SR1 position on MAIN BOOM to adjust its traveling angle. Adjust boom bend eye and SR4 position on JIB BOOM to adjust its traveling angle.
8. Move rudder control stick (right stick) left and right,rudder traveling angle to left and right are both around 35° . if not, adjust rudder servo neutral by pressing the rudder neutral position trim button on transmitter left or right.if still can't get it right, adjust pushrod by loosing screw on rudder arm.

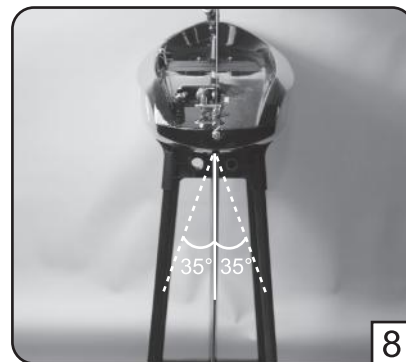
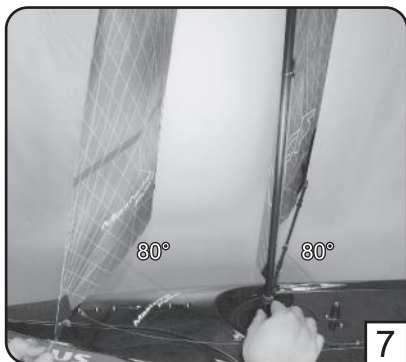

9. Rotate counterweight on front of jib boom by clockwise direction, adjust counterweight position, to make sure jib boom swing CG is located on SR2 and SR3 of Jib boom.
10. Turn off transmitter and power switch on deck, check all the cord tie and rigging, then apply cloth patch on deck hatch. It can be re-used for many times.

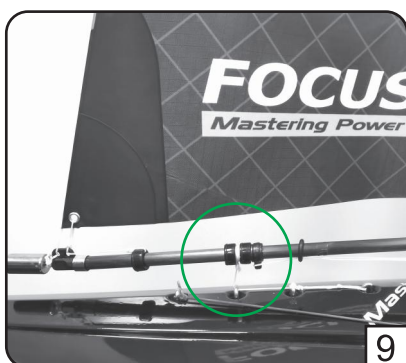

J4C05 Transmitter / J5C01R Receiver Introduction

Mode 2

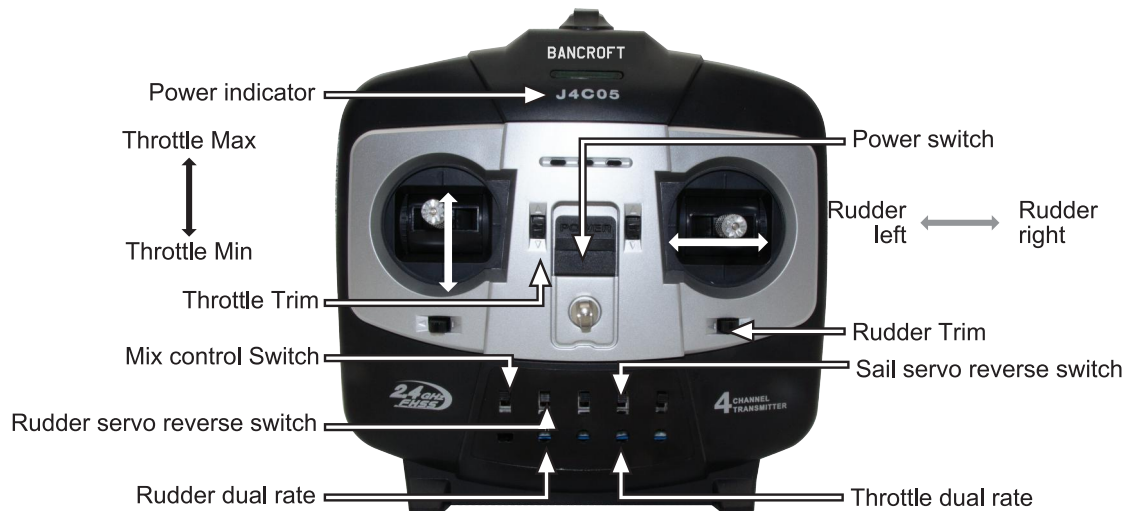

NOTE:

1. MXMD button is mix control ON/OFF button, switch up as "OFF" because FOCUS V3 don't need mix control.
2. Supplied plastic screwdriver on transmitter handle, use this part to adjust Rudder & Throttle dual rate.
3. Connect up the Servo, Winch and Battery Switch Cables up to the Receiver as follows:
 - Rudder Servo plugs into Channel 1 socket.
 - Sail/Winch plugs into Channel 3 socket.
 - On/Off Switch plugs into any rest socket

TRANSMITTER/RECEIVER BINDING

The binding process effectively ties the J4C05 transmitter and J5C01R receiver together. Under normal circumstances, both items are supplied like this from the factory. If, however, you find that your transmitter and receiver are not bound (receiver's red LED will be lighting), you should do the following:

1. Push down the throttle stick (Left Stick, MODE 2) till the end as shown. Switch "ON" the transmitter.
2. Switch "ON" the receiver by switching "ON" the battery box power button.
3. Press down the "BIND" button on the receiver as shown, until the receiver's red LED flash then let go, the receiver's green LED will be lighting to indicate that binding has been successful and the receiver will now accept commands from the transmitter.

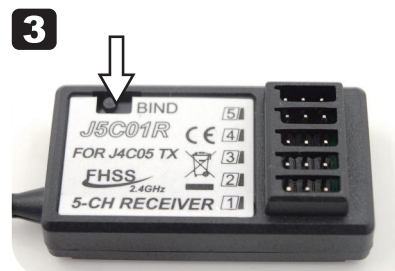

Note 1: You would also need to carry out the binding process if you were to replace the included receiver with another one.

Note 2: Typically, for the binding process to be effective, transmitter and receiver should be no more than one meter apart and no other similar devices should be within 10 meters of both during setup.

PREPARATIONS FOR SAILING

Before sailing your FOCUS V3 for the first time, take note of the following:

1. Always turn the transmitter on before the receiver, likewise, turn the receiver off before the transmitter.
2. Check that each sail, rigging rings and fitting is properly installed and adjusted
3. Switch off "MXMD" button on top position, because FOCUS V3 don't need mix control function.

Following the procedures to check the radio and sailboat's function: (MODE 2 as example)

1. FOCUS V3 RTR is supplied with 2.4GHz 4CH radio system. For sailing the FOCUS V3, you will only need 2CH. Please see following function of the transmitter.
 2. For sail control stick, when stick is in the position of A, correspondingly, the main boom and jib boom are in the position of A as shown. When stick is in the position of B, correspondingly, the main boom and jib boom are in the position of B as shown. If this is not the case, simply move the sail servo reverse switch to the other position. You may also adjust the sail servo neutral by pressing the sail neutral position trim button up or down.
 3. For rudder control stick, rudder turn left when rudder control stick is pushed to the left. Rudder turn right when rudder control stick is pushed to the right. If this is not the case, simply move the rudder servo reverse switch to the other position. You may also adjust the rudder servo neutral by pressing the rudder neutral position trim button left or right
 4. Use supplied plastic screwdriver to adjust the rudder dual rate, this is to adjust the rudder throw angle from the centreline in either direction when the rudder control stick is moved to it's maximum throws. Refer to FOCUS V3 boat manual for the rudder throw angle.
 5. Use supplied plastic screwdriver to adjust the throttle dual rate. This is to adjust the winch line travel distance between the fully sheeted in position (for sailing 'close hauled' - close to the wind) and fully sheeted out position (for sailing on a 'run' - sailing in the same direction as the wind with the sails fully out). Refer to FOCUS V3 boat manual for the winch line travel distance.

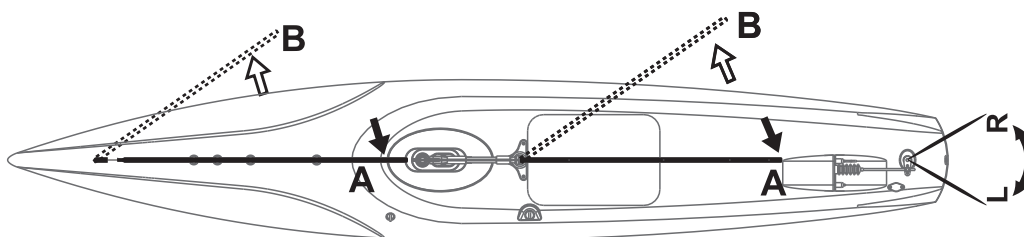

TRANSMITTER MODE SWITCHING

J4C05 2.4GHz 4CH transmitter is supplied with MODE 2 as standard set, If needed, you could simply switch to MODE 1 by easy steps as belowing:

Step 1: Open battery cover, switch MODE button to MODE 1.

Step 2: Use screwdriver to screw down the up-left screw tightly as photo shown.

Step 3: Screw down the down-left screw as photo shown, but not fully tighten, adjust this screw tightness so as to adjust the throttle stick (right stick) spring tightness as you wanted.

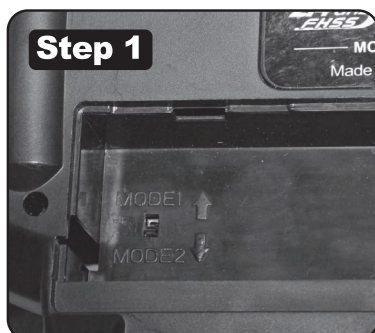

Step 4: Screw off down-right screw completely until the screw head is almost even with back panel.

Step 5: Screw off up-right screw, but not completely. adjust this screw tightness so as to adjust the Elevator stick(left stick) spring tightness as you wanted.



NOTE: If switch back form MODE 1 to MODE 2, firstly switch MODE button to MODE 2 under battery cover, screw off the left two screws, Screw down the right two screws, adjust down-left and up-right screws tightness so as to adjust the Throttle stick and Elevator stick spring tightness as you wanted.

SAILING THE FOCUS V3 SAILBOAT

Unlike propeller driven boats that you basically point and accelerate, sailboats present an interesting challenge. Sailing requires constant reaction to water movements, any wind gusts, and any wind direction changes. These reactions then require adjustment of the rudder and sails in order to find the best possible course. There is no substitute for actual "on-the-water" experience and after your first couple of outings you may want to read through this manual again in order to help you to gain a better understanding of the "art" of sailing. While learning to sail, it is a good idea to pick up on as much sailing terminology as possible. This will make it easier to grasp some aspects.

How To Sail Focus V3

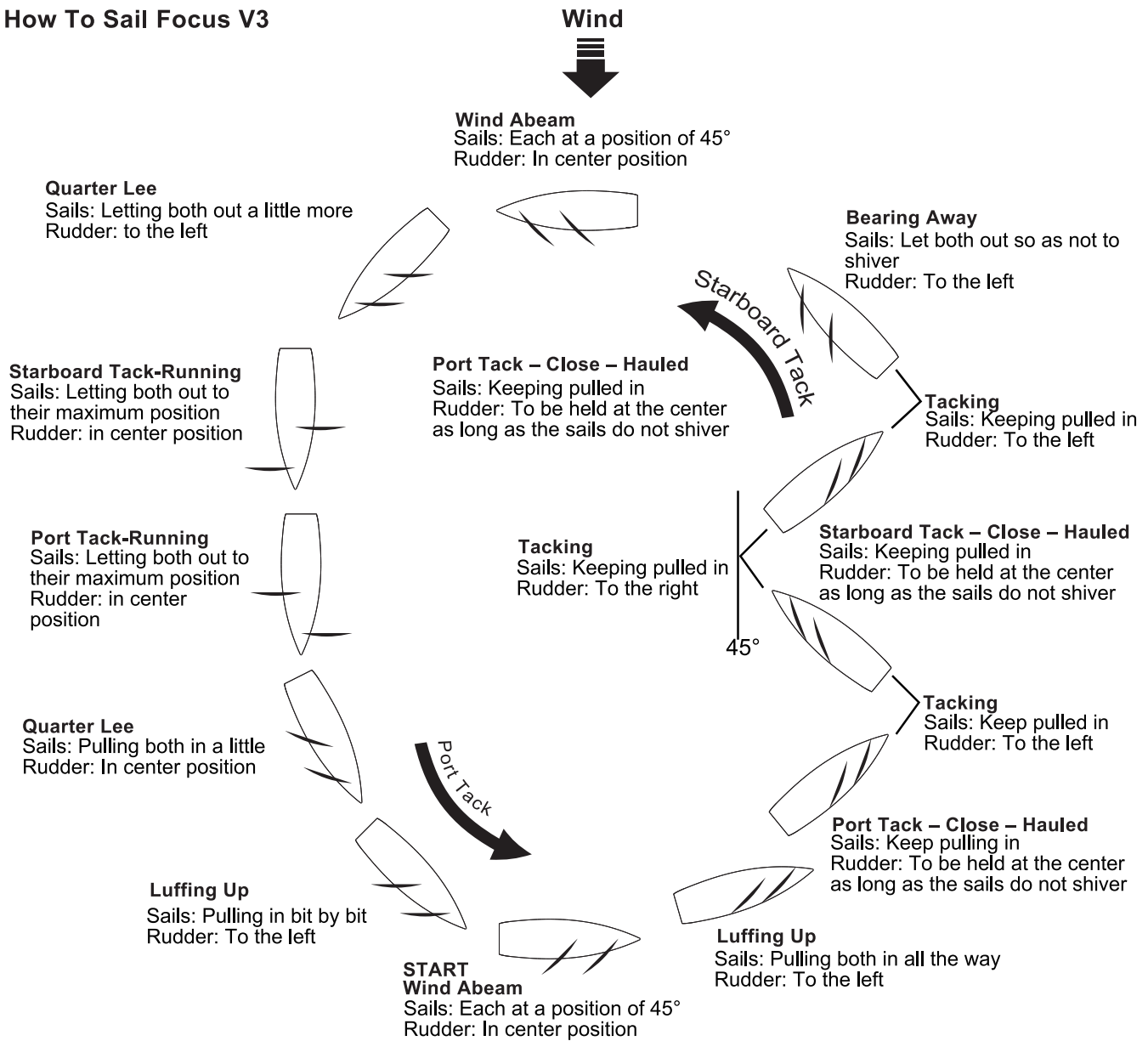

IMPORTANT NOTICE:

1. Sail your Focus V3 only in still bodies of water. Never sail your boat in running water such as streams or rivers, as it is easy to lose control of your boat.
2. Never attempt to swim after a stalled or stuck boat! Wait patiently for the wind currents to return the boat to shore.
3. After running, remove the deck and allow the interior of the boat to dry out completely. If you neglect to do this, it may result in corrosion of the electronic components.

SPARE PARTS LIST

To order Focus V3 spare parts, use the part numbers in the spare parts list that follows

PART NO.	DESCRIPTION
----------	-------------

- | | |
|-------------|--|
| BNC1047-101 | Bancroft Focus II Mainsail Luff Rings (10 Pack) |
| BNC1047-102 | Bancroft Metal Sail Clew Hook (10 Pack) |
| BNC1047-103 | Bancroft 0.6mm Dyneema Cord (10m Length) |
| BNC1047-106 | Bancroft Carbon Backstay Crane Set |
| BNC1047-108 | Bancroft Jib Boom Counterweight With Shaft (4 Pack) |
| BNC5072-003 | Bancroft Bowsie (Pk10) |
| BNC1047-109 | Bancroft Silicon Tube (18 Pack) w/ O-Ring (4 Pack) |
| BNC1047-110 | Bancroft Sheeting Elastic(2M) |
| BNC1047-111 | Bancroft Focus II Sheeting Pulley Block (2 Pack) |
| BNC1047-112 | Bancroft Focus II Pushrod (2 Pack) |
| BNC1047-113 | Bancroft Focus II Switch Connector & Switch Rod |
| BNC1047-115 | Bancroft Aluminum Alloy Rudder Arm Set |
| BNC1047-116 | Bancroft Plastic Servo Tray With Screws |
| BNC1047-117 | Bancroft Focus II Fin Box And Mast Fitting |
| BNC1047-118 | Bancroft Focus II Bolts For Keel (2 Pack) |
| BNC1047-120 | Bancroft Focus II Rudder |
| BNC1047-122 | Bancroft Focus II deck cloth patch (PK4) |
| BNC1047-123 | Bancroft Focus II Jib Hook (10 Pack) |
| BNC1047-124 | Bancroft Sail Winch Servo for Focus II and Orion V2 |
| BNC1047-125 | Bancroft Waterproof Bellows 4 Pcs |
| BNC1047-126 | Bancroft DF65 & DF95 Cord Attachment Clip (2020) (10 Pack) |
| BNC1047-128 | Bancroft Focus II Main Boom Sheeting Guide |
| BNC1047-132 | Bancroft Focus V3 Blue main sails & Jib sails set |
| BNC1047-133 | Bancroft Focus V3 Red main sails & Jib sails set |
| BNC1047-134 | Bancroft Focus V3 complete rig & fitting exclude sails |
| BNC1047-135 | Bancroft Focus V3 mast & backstay crane set |
| BNC1047-136 | Bancroft Focus V3 main and Jib booms set |
| BNC1047-137 | Bancroft Focus V3 hull with Blue decals and painting |
| BNC1047-138 | Bancroft Focus V3 hull with Red decals and painting |
| BNC1047-139 | Bancroft Focus V3 keel with bolts |
| BNC1047-140 | Bancroft Focus V3 ballast |
| BNC1047-141 | Bancroft Focus V3 Rudder post insert fitting |
| BNC1047-129 | Bancroft Focus II Deck Eyes (10 Pack) |
| BNC7009-004 | Bancroft Rubber Bung (Pk4) |
| BNC1047-130 | Bancroft Focus II Battery Box For Receiver |
| BNC1043-121 | Bancroft Winch Line Rubber Cap (Pk5) |
| BNC6005-009 | Bancroft DragonForce 65 / DragonFlite 95 New Digital Metal Gear Rudder Servo |
| BNC6008-005 | Bancroft J4C05 Transmitter |
| BNC6010-304 | Bancroft J5C01R 2.4GHz Receiver |
| BNC6009-100 | Bancroft J4C05 Transmitter & J5C01R Receiver Set |
| BNC1048-164 | Bancroft DF65/95/Focus Standard boat stand plus laydown upgrade kit |
| BNC1047-127 | Bancroft DF65 & DF95 Metal Rings (2020) 10 Pcs |

NEED SPARE PARTS OR TECHNICAL SUPPORT?

In USA, visit www.motionrc.com or call (224)633-9090
 In EU, visit www.motionrc.eu or call +31-30-8080557



Scan for customer and technical support



Scan for warranty information



Scan to see the entire assortment of Bancroft boats

©2023 Motion RC, LLC
 Printed in China



FCC REQUIREMENT



This device complies with Part 15 of the FCC Rules. Operation is subject to the following two conditions: (1) This device may not cause harmful interference, and (2) This device must accept any interference received, including interference that may cause undesired operation.

CAUTION: Changes or modifications to this product not expressly approved by the party responsible for compliance may void the user's authority to operate the equipment.