

THESE INSTRUCTIONS SHOULD BE READ BY A SUPERVISING ADULT

### MAGIC VEE V6 2.4HGz RTR

SKU #BNC1028-001

### MAGIC CAT V6 2.4HGz RTR

SKU #BNC1029-001

#### CONTENTS OF SET

1) Magic Vee V6 Racing Boat

OR

1) Magic Cat V6 Racing Boat

2) Transmitter

3) 6.4V 320mAh LiFePo4 Battery

4) 6.4V USB balance charger

5) Boat Stand

6) 4pcs AA batteries(for transmitter)

7) Allen Key (Only for Magic Vee Turn Fins)

8) Spare Silicone Coupler

9) Radio hanger & screws

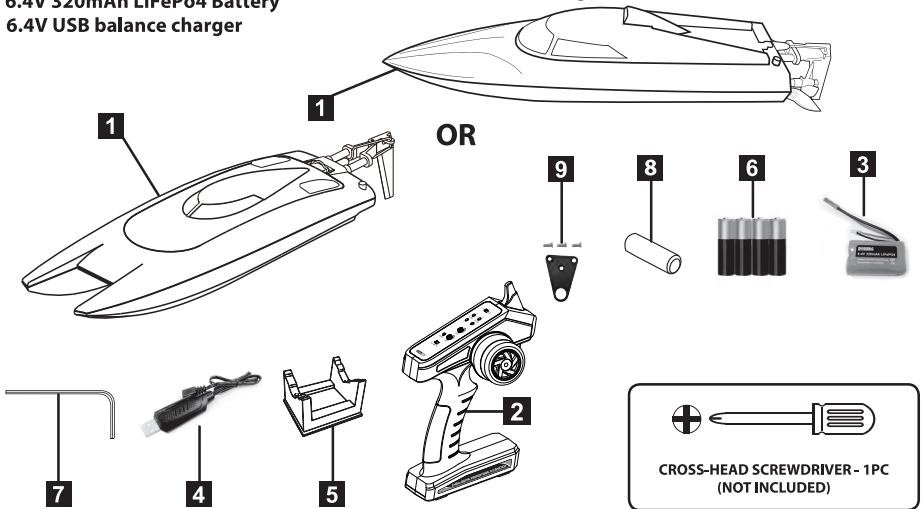

#### ATTENTION:

Before racing your model boat, carefully check silicone tube for guarantee good water cooling system; Avoid water inlet on the bottom of hull become deformed, otherwise, water cooling system failure, this may lead to ESC burned out and motor defected.

ESC with low voltage protection, as soon as you notice boat speed slow down obviously, you should drive the boat back to shore and recharge battery. Do not keep playing the boat when ESC low voltage protection active, otherwise, battery will be over discharged and might be damaged and won't be recharged again.

#### IMPORTANT

Magic Vee V6 and Magic Cat V6 are compatible with this manual.

The Magic Series are designed for use in fresh water only. They are not designed for use in salt water!

The Magic Series is not intended for persons under 14 years of age, unless closely supervised by an adult.

## INSTALLING TRANSMITTER BATTERIES

**NOTE:** The transmitter is not water resistant and should never come in contact with water.

1. Install four fresh "AA" batteries. Follow the diagram located in the bottom of the battery tray for proper battery orientation

2. Switch on transmitter, transmitter make sound "Bi", LED power light will be flashing.

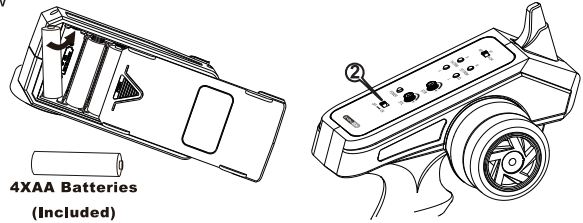

## RADIO HANGER

Triangle radio hanger and 3pcs screw are included in tool bag, use these to hang radio on your neck with ribbon.



## CHARGING THE 6.4V POWER PACK

- 1) Connect USB balance charger with USB port of computer equipment, mobile phone adapter or power bank. USB charger LED light turn to solid on.
- 2) Connect battery's charging plug with USB charger's charging port. USB charger LED light will turn to be off, this indicate that the battery is charging.
- 3) A fully discharged battery will take about 3 hours to be fully charged. Do not leave the battery unattended while charging.



4) The LED light will turn to be solid on when the charge is complete. Disconnect the 6.4V LiFePo battery from the charger.

- The 6.4V LiFePo battery does not come pre-charged. You must fully charge the battery before using the boat.
- The 6.4V LiFePo battery can be re-charged many times before it needs to be replaced. When the battery no longer holds a charge (is dead), it should be properly recycled.

**NOTE 1:** The boat will run for about 8 mins on a fully charged battery. As soon as you notice a drop off in speed, you should bring the model back to shore to recharge battery or you may lose control of the boat.

**NOTE 2:** Continuous running of the model will generate high heat levels, which will lead to premature wear on the motor. It is recommended to let the model cool down for about 5-10 min before installing a re-charged battery pack.

## INSTALLING THE 6.4 V POWER PACK IN THE MAGIC SERIES

### (Always switch on transmitter before connecting the battery with ESC)

- 1) Remove the Magic Series's upper deck by pulling carefully on the catch at its rear section.
- 2) Insert the 6.4V Power Pack into the left side of the hull.
- 3) Attach the 6.4V Power Pack's connector to the matching connector in the Magic Series. Do not force them together - they only attach one way!
- 4) Re-position the upper deck.

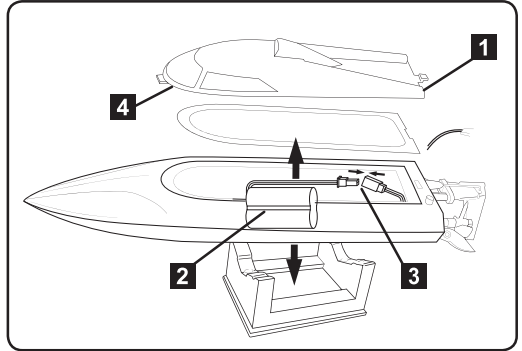

**NOTE:** 1. There is a water proof rubber ring placed along the slot of hull, always make sure it's secured positioned before re-position the upper deck.

## TRANSMITTER/RECEIVER BINDING

transmitter and receiver are automatically binding once they are power on. No need to press any bind button. Just make sure no other transmitter or receiver should be powered on near by.

- 1) Switch on transmitter, transmitter make sound "Bi", LED power light will be flashing.
- 2) Connect battery with boat's ESC, transmitter make sound "Bi Bi", LED power light turn to solid on, now transmitter have automatically bind with boat.

## CHECKING THE RADIO SYSTEM

1. Always switch on the transmitter before connecting the battery with the ESC.
2. Connect battery with boat's ESC
3. Pull the throttle & motor rotate in anticlockwise direction, your motor is now armed and ready for operation.
4. Check the direction of the rudder, the trailing edge of the rudder should turn right when right input is given, Conversely, when left input is given, the trailing edge of the rudder should turn left.

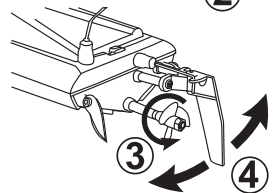
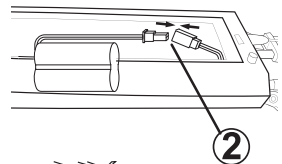
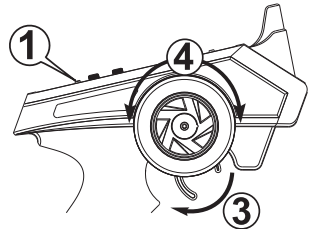

**NOTE:** The left and right steering angle are pre-set as standard angle to suitable for common boat driving style. If you want to change the turning radius, you can adjust the two knobs on transmitter "ST/R", "ST/L". more detail information refer to "EPA ADJUSTMENT".

## MAGIC VEE TURN FINS & SELF-RIGHTING

The Magic Vee features adjustable turn fins to aid in turning. These can be adjusted using the included Allen key. The optimum angle of adjustment is 45 degrees to the hull.

Magic Vee deep vee boat designed with self-righting function. When boat accidentally capsizes in fast speed and big wave driving, no worries, pull the throttle trigger, boat will automatically self-righting and you can drive the boat again.

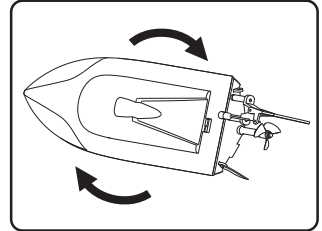
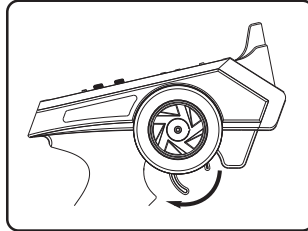
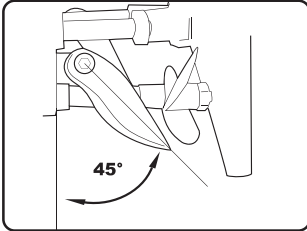

## DRIVING YOUR MAGIC SERIES

- 1) Switch on transmitter, transmitter power LED light flash.
- 2) Check that the Magic Vee's turn fins are adjusted correctly.
- 3) Switch 'ON' the Magic Series's (connect the 6.4V Power Pack).
- 4) Check that the propeller and the rudder respond to transmitter inputs before placing the Magic Series on the water.

### AFTER USE

- 1) When you have finished using your Magic Series, you should first switch 'OFF' the model (disconnect the 6.4V Power Pack), then switch 'OFF' your transmitter.
- 2) Remove all batteries from the transmitter and model.
- 3) Leave the Magic Series's upper deck off to allow moisture to evaporate. Ideally, place the model in this way in a warm and dry place, like an airing cupboard, until you are sure it is dry and then store it away.

**NOTE:** If the Magic Series begins to bob when running, it may have taken on an excessive amount of water. In this case, you should immediately return to shore, remove the upper deck and drain the water from the hull.

## TRANSMITTER INTRODUCTION

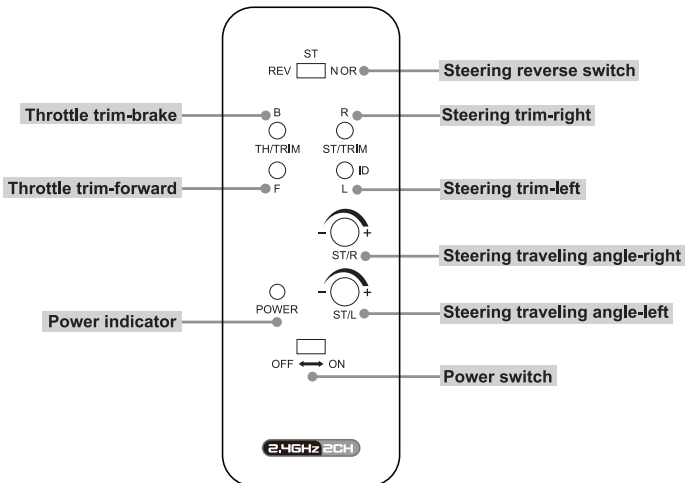

## EPA ADJUSTMENT

### Function

Use this when performing left and right steering angle adjustments. End Point Adjustment (EPA) adjusting value range: 0%-100%

### Setting

1. Steering (right side) angle adjustment Rotate “ST/R” knob to the left end point means minimum value 0%, right end point means maximum value 100%.
2. Steering (left side) angle adjustment Rotate “ST/L” knob to the left end point means minimum value 0%, right end point means maximum value 100%.

### CAUTION:

When adjusting this function, make sure the direction is in agreement with the boat direction, you can adjust by the STEERING “REV-NOR” button.

### Steering reverse switch

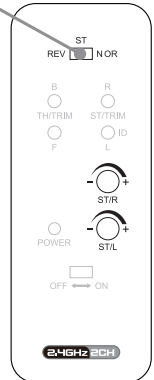
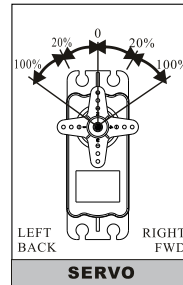

## TRIM ADJUSTMENT

### Steering trim

Adjust “ST/TRIM” “R/L” so that rudder is centered prior to operation, you may adjust this control to make the boat run straight during operation.

### CAUTION:

When adjusting steering trim, make sure the direction is in agreement with the boat direction, you can adjust by the STEERING “REV-NOR” button.

### Steering reverse switch

### Throttle trim

Adjust “TH/TRIM” “B/F” to stop propeller from turning while the throttle trigger is in the neutral position.

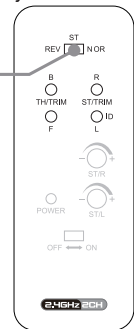

## LUBRICATING DRIVE SHAFT

Lubricating the flexshaft is vital to the life of the drivetrain. The lubricant also acts as a water seal, keeping water from entering the hull through the stuffing tube. It is recommended to lubricate the flexshaft, propeller shaft after every 2 or 3 times of operation.

1. Use one hand to hold the silicone coupler tight, while other hand to pull the propeller shaft out from the stuffing tube.
2. Lubricate the flexshaft w/ prop shaft with the water proof marinegrease, reinstall the flexshaft w/ prop shaft in reverse order, be sure to push the flexshaft end into the silicone coupler for fully connection.

**NOTE: After several times of pulling the flexshaft out from the silicone coupler, the silicone coupler might lose flexibility that make the connection of flexshaft end not good. Once this happens, It is suggested to replace the silicone coupler with new one, which is supplied in the kit bag.**

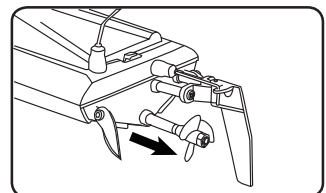
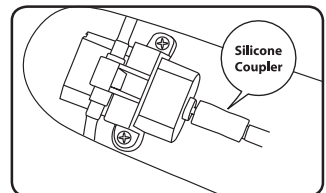

## CAUTION!

**Please observe the following warnings.**

### DURING OPERATION

- The transmitter's range will vary depending on your surroundings and battery strength. Do not operate Magic Series too far away or control will be lost.
- Ensure that all batteries are correctly installed and that the 6.4V Power Pack is fully charged.
- Do not touch moving parts during operation, especially the propeller.
- If you lose control of your Magic Series, never wade into deep water or water with strong currents to retrieve it. First, hold the transmitter as high as you can to try to re-establish control. If this does not work, find another way to move closer to the model, but do not endanger yourself in the process!

### CARE WITH RECHARGEABLE BATTERIES (THE POWER PACK)

Care must be taken when handling rechargeable batteries (the Power Pack) to avoid the possibility of injury and/or damage to property. Do not short circuit, disassemble or incinerate rechargeable batteries. It is very dangerous to disregard these warnings.

### GENERAL INFORMATION FOR THE SAFE OPERATION OF YOUR MAGIC SERIES

**Please follow these simple rules to ensure safe operation and gain the maximum enjoyment from your model.**

- Avoid overloading your model. Never run it in areas where its movement will be restricted, e.g. areas where there is pond weed, etc., as this can over stress the motor.
- Ensure nothing prevents the smooth running of moving parts.
- Do not run your model in confined spaces.
- Never run your model in a public space where it might upset or endanger people or wildlife.
- Immediately switch 'OFF' your model and transmitter if you see lightning or hear thunder. Never use your model in the rain.

Do not dismantle or tamper in any way with this R/C vehicle and its transmitter. The manufacturer and distributor will accept no responsibility, expressed or implied, for accidents or injuries caused as a result of disassembly, modification and/or usage against the Instructions for this product.

Tampering or modification will also invalidate the guarantee.

## TROUBLE SHOOTING

Check using the chart below before returning your Magic Series for repair as many problems can be easily solved.

PROBLEM	CAUSE	REMEDY
Model will not move	No battery in transmitter/model Battery installation is incorrect Weak battery in transmitter Weak batteries in model	Install batteries Install batteries correctly Install a fresh battery Recharge 6.4V Power Pack
No control of model	Weak battery in transmitter	Install a fresh battery
Limited radio range	Weak battery in transmitter	Install a fresh battery

## SPARE PARTS

BNC6000-004	Bancroft 180 Brushed Motor
BNC7008-001	Bancroft Flex Shaft
BNC1028-101	Bancroft Magic Vee Rudder & Turn Fins
BNC1029-101	Bancroft Magic Cat Rudder
BNC6024-001	Bancroft 320mAh 2S 6.4V LiFePO4 Battery with JST Connector
BNC5059-001	Bancroft Rubber Driveshaft Coupler (2 Pack)
BNC6026-001	Bancroft 6.4V USB Charger
BNC6008-003	Bancroft J2C96 2.4GHZ 2CH Transmitter
BNC6004-001	Bancroft ESC/2.4 GHz Receiver/Servo Set
BNC1028-100	Bancroft 225mm Magic Vee V6 Micro Hatch
BNC1029-102	Bancroft Magic Cat V6 Hatch/Rubber Ring
BNC5077-001	Bancroft 3-Blade Propeller (2 Pack)

NEED SPARE PARTS OR TECHNICAL SUPPORT?

In USA, visit [www.motionrc.com](http://www.motionrc.com) or call (224) 633-9090

In EU, visit [www.motionrc.eu](http://www.motionrc.eu) or call +31-30-8080557



*Scan for customer and technical support*



*Scan for warranty information*



*Scan to see the entire assortment of Bancraft boats*

©2023 Motion RC, LLC

Printed in China



**FCC REQUIREMENT**



This device complies with Part 15 of the FCC Rules. Operation is subject to the following two conditions: (1) This device may not cause harmful interference, and (2) This device must accept any interference received, including interference that may cause undesired operation.

**CAUTION:** Changes or modifications to this product not expressly approved by the party responsible for compliance may void the user's authority to operate the equipment.