

Jiro Swivel Chair

PRODUCT NAME

Jiro Swivel Chair

DIMENSIONS

H: 81cm, L: 48.5/56.5cm, D: 51cm

GENERAL LEAD TIME

6 to 8 weeks

BRAND

Resident

MATERIAL

Aluminium, Oak Veneer, Upholstered Foam Pad

CUSTOMISABLE

Yes

DESIGNER

John Tree

OPTIONS

Non-Upholstered or Upholstered Seat / Swivel or Swivel with Casters

PACKING DIMENSIONS

53 x 53 x 80cm (9.4kg)

CATEGORY

Desk Chair **INDOOR**

FINISHES

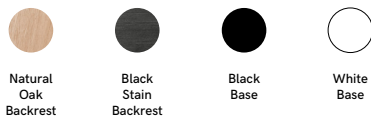

CERTIFICATIONS

CAL 117-2013, BS 5852 Crib 5, EN 1021-1 EN 1021-5, FSC Certified Wood

Diagonal base width 67.5cm (26.1")

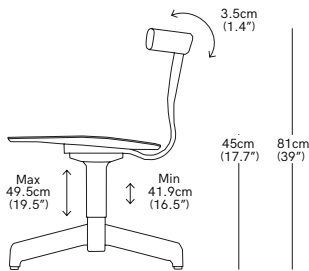
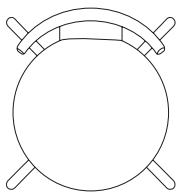

Diagonal base width 75.5cm (29.7")

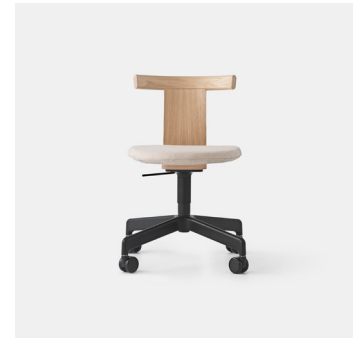
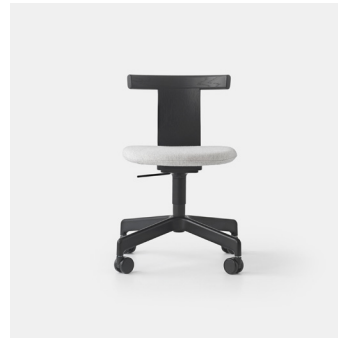
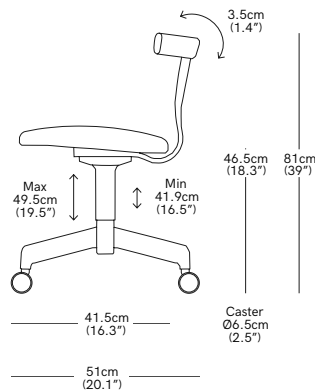
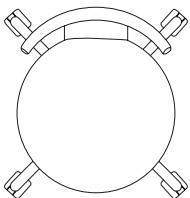

ADDITIONAL INFO Fabric Options & Categories

Category One - Maharam Mode / COM
 Category Two - Camira Synergy / Mainline Flax
 Category Three - Kvadrat Hallingdal 65 / Sorensen Envj

Fabric usage 0.7 m (0.8 yd) / Leather usage 1.2 m2 (12.9 ft2)

COM options must be approved by Resident to ensure suitability for upholstery.

Related Products

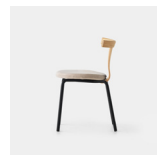

Jiro Chair

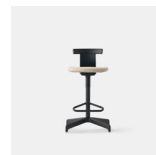

Jiro Bar Stool

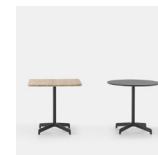

Jiro Bistrot Table