



Marenco

PRODUCT NAME

Marenco

DIMENSIONS

H: 70cm, D: 96cm

GENERAL LEAD TIME

8 to 10 weeks

BRAND

Arflex

MATERIAL

Metal, Poplar Plywood, Birch Plywood, Shaped Polyurethane, Polyester, Fabric (Fully Removable Cover), Leather

CUSTOMISABLE

Yes

DESIGNER

Mario Marenco

FINISHES



**Black
Lacquered
Metal**

PACKING DIMENSIONS

N/A

CATEGORY

Sofa, Armchair & Pouf INDOOR

CERTIFICATIONS

N/A



ADDITIONAL INFO **Fabric Options & Categories**

- T2: Cabas, Derby, Etoile
- T3: Boucle, Cherie, Lama, Otis
- T4: Hero 2 by Kvadrat, Mistral, Orbaco, Steelcut 3 by Kvadrat, Swing
- T5: Divina MD by Kvadrat, Gamma, Vega
- N: Giada
- Super: Ametista, Perla

COM options must be approved by Arflex to ensure suitability for upholstery.

Related Products



Marenco Outdoor

Marenco

Armchairs without armrests

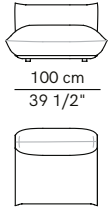
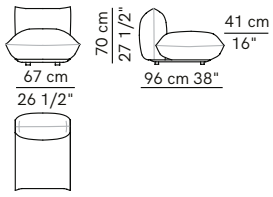

Armchair with 2 armrests

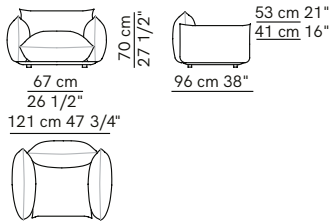

Sofas

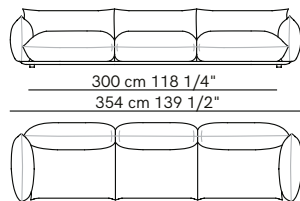
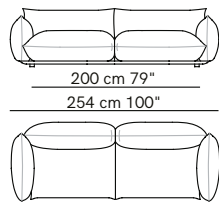
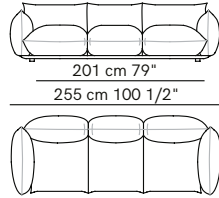
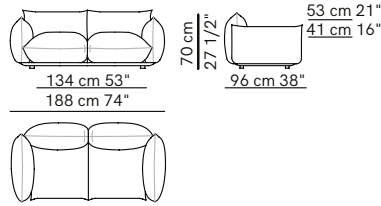

Units with 1 armrest

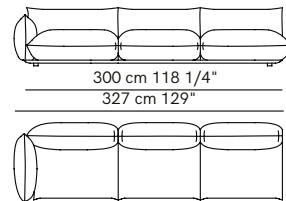
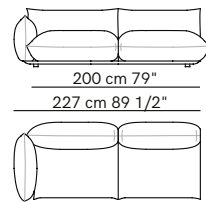
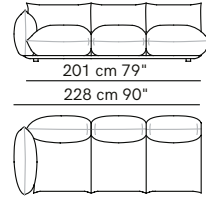
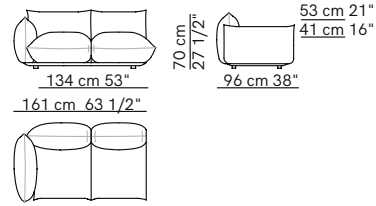

Units without armrests

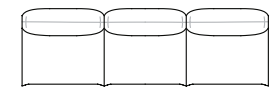
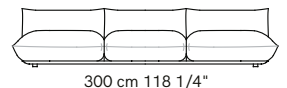
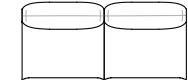
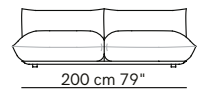
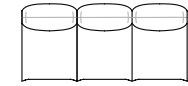
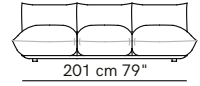
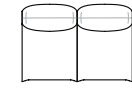
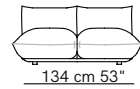

Marenco

Corner units

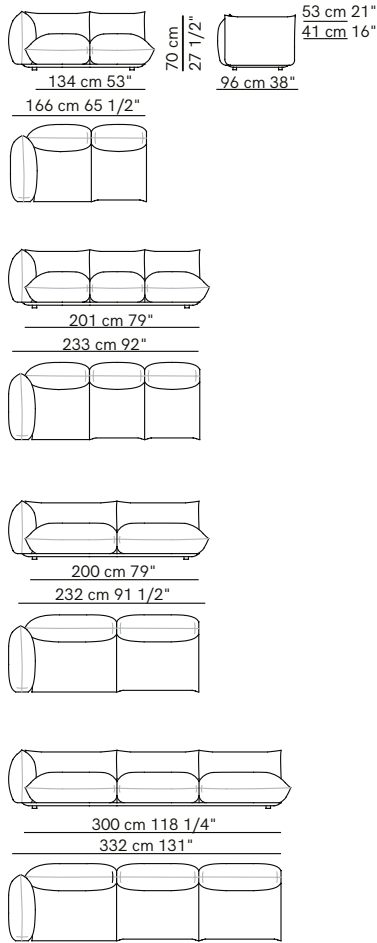

Corner units with 1 armrest

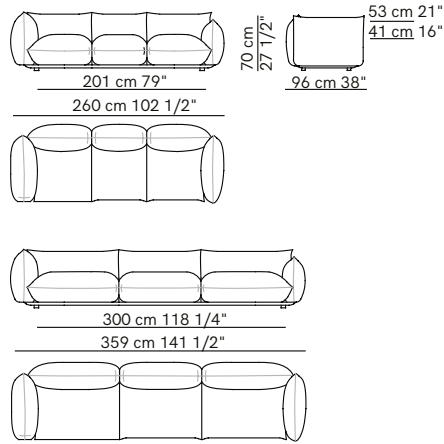

Isle units with corner

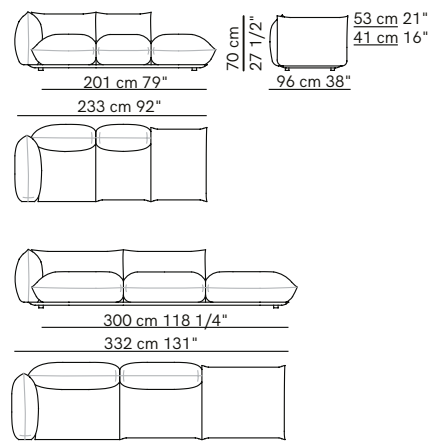

Pouf

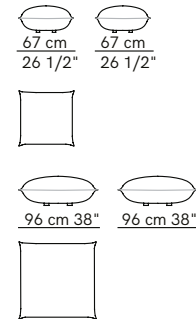

Compositions

