



Lee

PRODUCT NAME

Lee

DIMENSIONS

Depending on the composition

GENERAL LEAD TIME

8 to 10 weeks

BRAND

Arflex

MATERIAL

Poplar Plywood, Fir Plywood, Shaped Polyurethane, Lacquered Metal, Fabric (Fully Removable Cover)

CUSTOMISABLE

Yes

DESIGNER

Fabrizio Ballardini

FINISHES



Black
Lacquered
Metal

PACKING DIMENSIONS

N/A

CATEGORY

System Sofa & Pouf INDOOR

CERTIFICATIONS

N/A



ADDITIONAL INFO **Fabric Options & Categories**

- T2: Cabas, Derby, Etoile
- T3: Boucle, Cherie, Lama, Otis
- T4: Hero 2 by Kvadrat, Mistral, Orbaco, Steelcut 3 by Kvadrat, Swing
- T5: Bridge, Divina MD by Kvadrat

Leather version not available.

COM options must be approved by Arflex to ensure suitability for upholstery.

Lee

Sofas

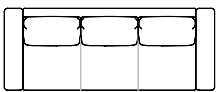
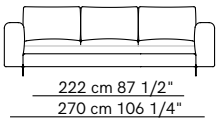
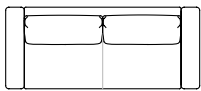
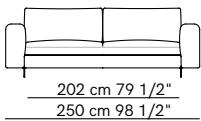
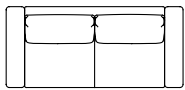
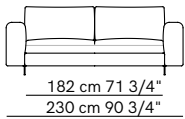
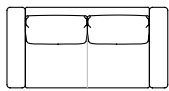
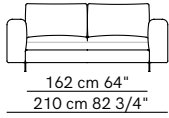
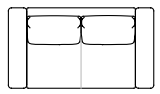
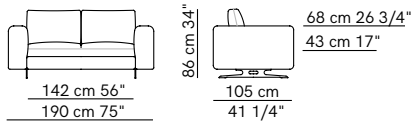

Units with 1 armrest

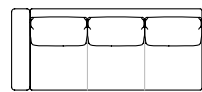
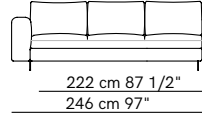
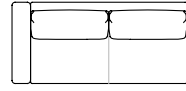
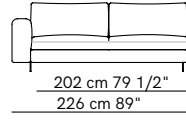
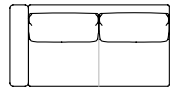
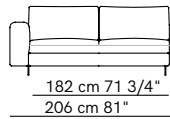
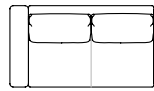
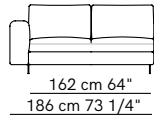
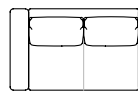
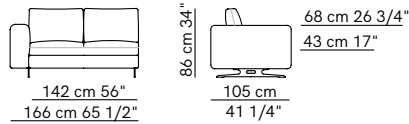

Units without armrests

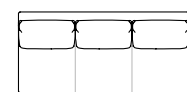
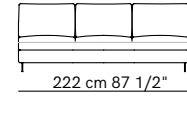
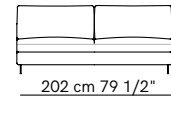
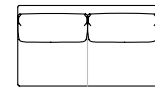
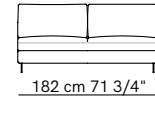
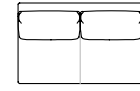
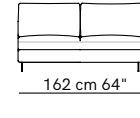
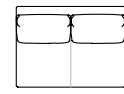
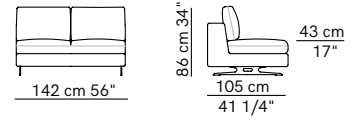

Lee

Corner units with 1 armrest

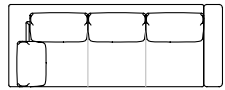
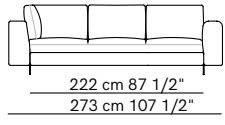
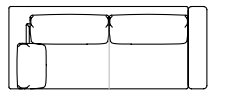
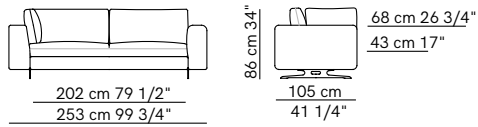

Isle units with corner unit

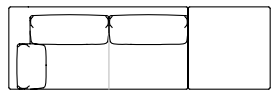
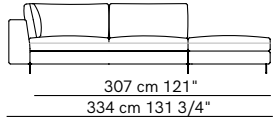
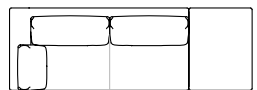
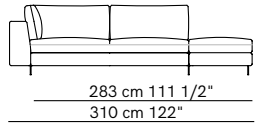
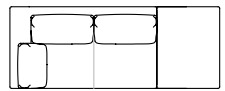
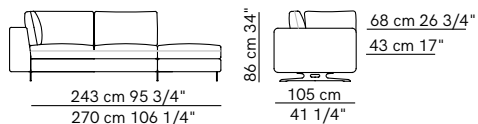

Compositions

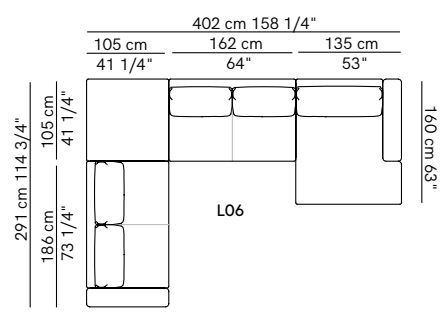
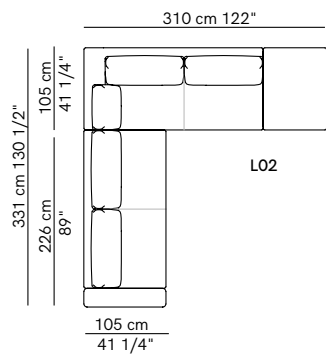
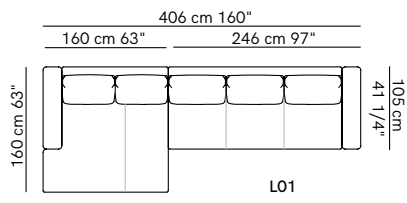

Chaise longue with 1 armrest

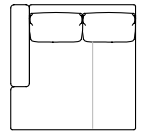
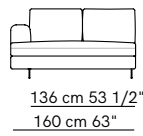
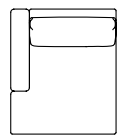
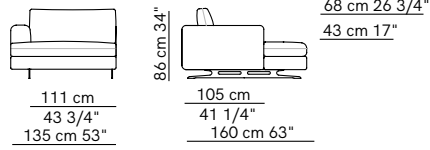

Pouf

