

Arcolor Sofa

PRODUCT NAME

Arcolor Sofa

DIMENSIONS

Depending on the composition

GENERAL LEAD TIME

8 to 10 weeks

BRAND

Arflex

MATERIAL

Metal, MDF, Shaped Polyurethane, Polyester, Ash, Fabric (Fully Removable Cover)

CUSTOMISABLE

Yes

DESIGNER

Jaime Hayon

FINISHES (BASE / FEET)



PACKING DIMENSIONS

N/A

CATEGORY

Sofa INDOOR

CERTIFICATIONS

N/A



ADDITIONAL INFO Fabric Options & Categories

- T2: Cabas (No Piping), Derby, Etoile
- T3: Boucle (No Piping), Cherie (No Piping), Lama, Otis
- T4: Hero 2 by Kvadrat, Mistral (No Piping), Orbaco, Steelcut 3 by Kvadrat, Swing (No Piping)
- T5: Bridge (No Piping), Divina MD by Kvadrat

Leather version not available.

The piping can never be made in velvet.
The piping will never be regular along the shapes of the sofa.

COM options must be approved by Arflex to ensure suitability for upholstery.

Related Products



Arcolor Table



Arcolor Sofa



Arcolor Sofa

Sofas

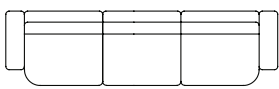
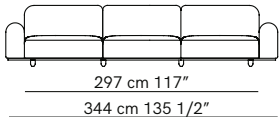
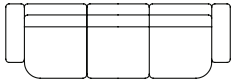
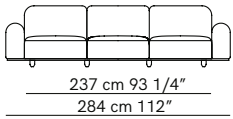
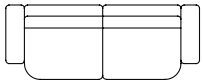
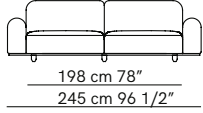
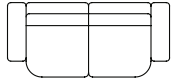
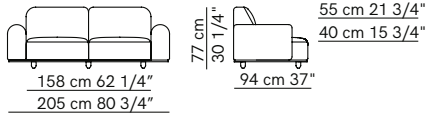

Corner unit



Units with 1 armrest

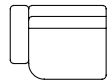
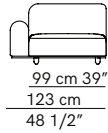
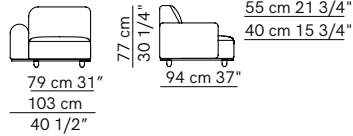

Trapezoid sofas

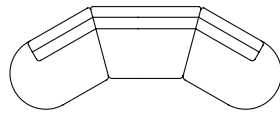
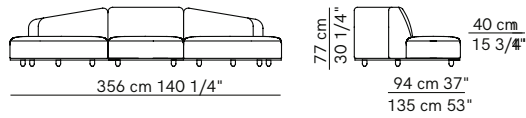
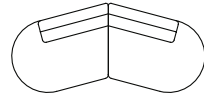
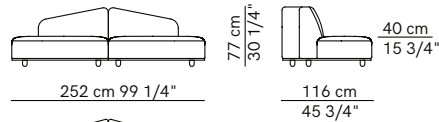

Trapezoid isle units

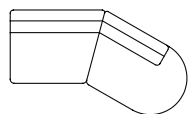
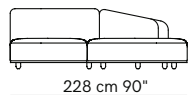
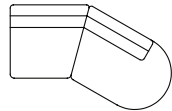
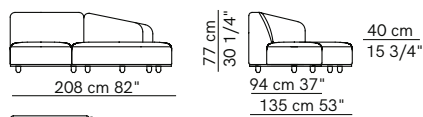

Units without armrests

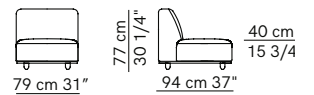

Pouf

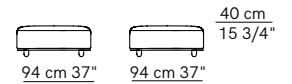

Pouf for isle units

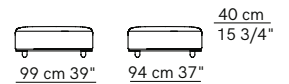
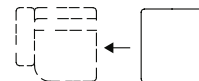

Corner small table

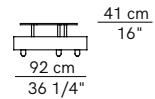

Arcolor Sofa

Compositions

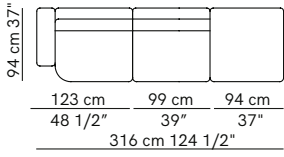

AR01

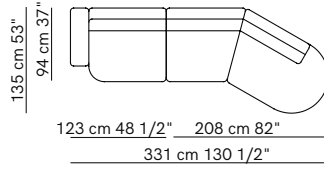

AR02

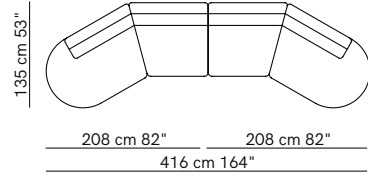

AR03

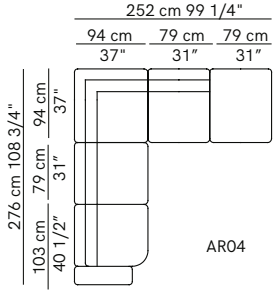

AR04

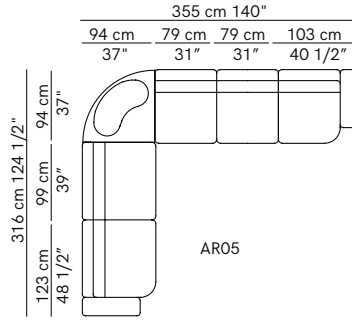

AR05

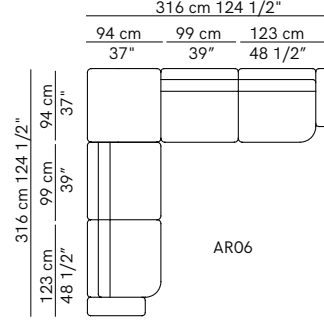

AR06

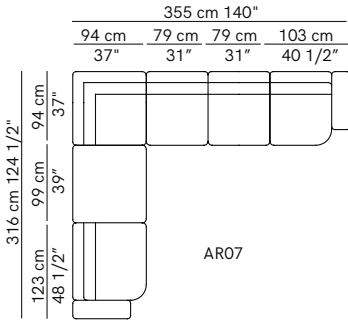

AR07

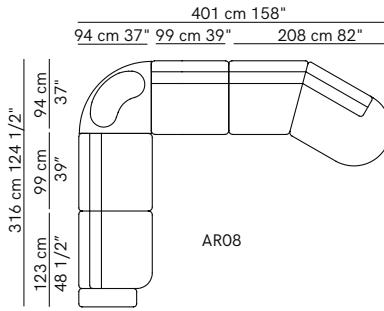

AR08