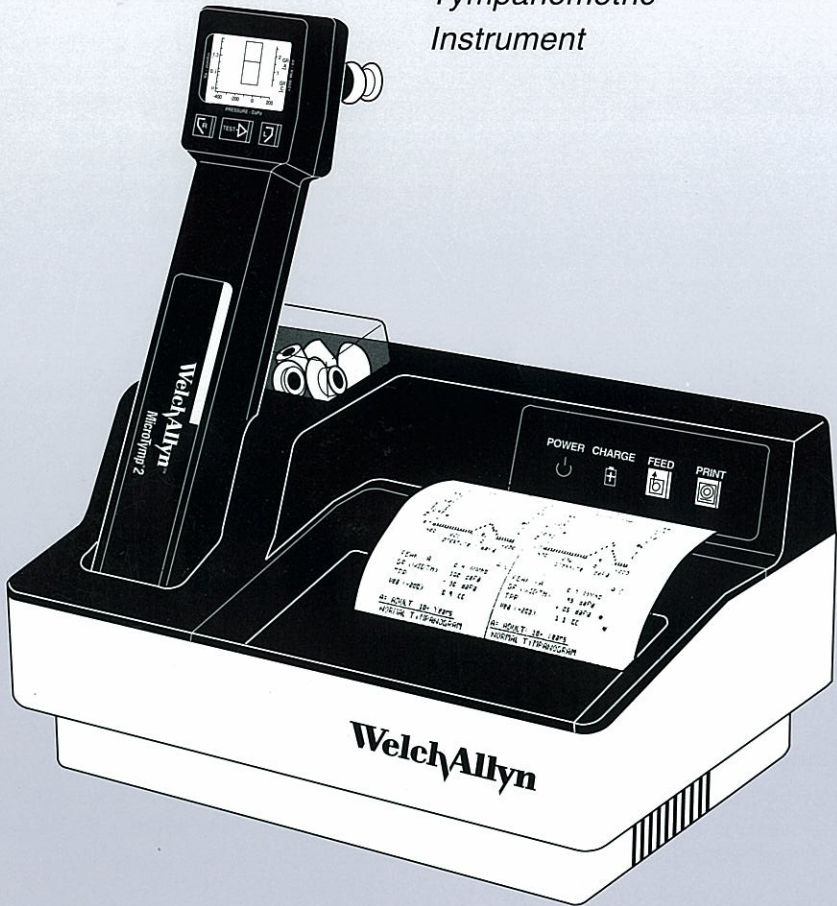


# WelchAlllyn™

## MicroTymp® 2

Portable  
Tympanometric  
Instrument



---

## Operating Instructions

---

## **Acknowledgments**

Welch Allyn gratefully acknowledges the assistance of Robert H. Margolis, Ph.D. of the University of Minnesota for his assistance in preparing the Guide to Tympanometry and Glossary sections of this manual.

## **Trademarks**

Welch Allyn and MicroTymp are registered trademarks of Welch Allyn, Inc. in the United States and other countries.

## **Patents**

MicroTymp – U.S. Patent Number 4,688,582

Conductive Path ESD Shield – U.S. Patent Number 5,383,097

# Contents

---

## MicroTymp2 – Introduction

MicroTymp2 Handle Components .....	2
MicroTymp2 Printer/Charger Components .....	3
Preparing to Use the MicroTymp2 Handle and Printer/Charger .....	3
Setting up the MicroTymp2 Handle and Printer/Charger .....	4

## MicroTymp2 – Completing a Test

Obtaining a Tympanogram .....	5
Selecting a Probe Tip .....	5
Testing .....	6
Storing and Erasing Data .....	7
Displaying Memory Contents .....	8
Erasing Memory Contents .....	8
Understanding the Liquid Crystal Display (LCD) and Its Messages .....	8
Gradient (Width) Measurements .....	8
Printing Memory Contents .....	15
MicroTymp2 Printout Formats .....	16
Description of Formats .....	16
Selecting Printout Formats .....	20
Changing from Manual to Automatic Printout .....	20
Changing Printout Format .....	21
Printer Function Messages .....	23
Printer Service Codes .....	24

## Appendix A – Guide to Tympanometry

Basic Principles of Tympanometry .....	A-25
Tympanogram Characteristics .....	A-26
How the MicroTymp2 Instrument Works .....	A-27
Normative Values for the MicroTymp2 .....	A-28
Interpreting Tympanogram Results .....	A-29
Obtaining a Valid Tympanogram .....	A-31
Tympanometry in Young Infants .....	A-31
Conditions Which Cause Too Much Artifact .....	A-31
Conditions Which Artificially Flatten the Tympanogram .....	A-32
The Normal Ear .....	A-33
Low-Admittance Pathologies .....	A-34
Tympanic Membrane Abnormalities .....	A-36
Conditions Which Cause Negative Middle Ear Pressure .....	A-37
Conditions Which Cause Positive Middle Ear Pressure .....	A-37

## Appendix B – Guidelines for Screening for Hearing Impairments and Middle Ear Disorders .....

Recommended Screening Protocol .....	B-39
Audiological or Medical Referral .....	B-41
Audiological or Medical Referral .....	B-42

---

## **Appendix C – Maintaining the MicroTymp 2 Equipment**

The MicroTymp 2 Battery .....	C-43
Recharging the Battery .....	C-46
Recycling the Battery .....	C-47
Paper Replacement .....	C-48
Cleaning, Disinfection and Sterilization .....	C-50
Cleaning the MicroTymp2 Handle .....	C-50
Printer/Charger Cleaning .....	C-50
Disinfection and Sterilization of the Probe Tips .....	C-50

## **Appendix D – Functional Checks of the MicroTymp 2 Handle and Printer/Charger**

Functional Checks of the MicroTymp2 Handle .....	D-51
Troubleshooting the MicroTymp2 Handle .....	D-53
Functional Checks of the Printer/Charger .....	D-53

## **Appendix E – Service and Warranty Information**

Service .....	E-55
Repair .....	E-55
Recalibration .....	E-55
Warranty .....	E-56
MicroTymp 2 Instrument .....	E-56
MicroTymp 2 Rechargeable Battery .....	E-56

## **Appendix F – Technical Specifications** ..... F-57 |

## **Appendix G – MicroTymp 2 Replacement Parts and Accessories** . G-61 |

## **References** ..... 63 |

## **Glossary** ..... 65 |

# MicroTymp2 – Introduction

---

Thank you for purchasing the Welch Allyn MicroTymp2 Portable Tympanometric Instrument.

The Welch Allyn MicroTymp2 provides portable tympanometry which is automatic, easy to use, and offers the following features:

- Measures middle ear function in as little as one second
- Displays results as they happen
- Stores data from two ears before printing
- Prints out hardcopy automatically or on demand in five seconds

With MicroTymp2 tympanometry, objective, printed documentation of otitis media with effusion and other middle ear disorders is quickly and easily obtained. This results in more thorough diagnoses, and more effective monitoring, treatment, parent consultation, and referrals.

Data stored in the memory of the MicroTymp2 Handle may be printed using the Printer/Charger. The Printer/Charger reads the information from the Handle and quietly prints out tympanograms from two ears with test results in five seconds.

The MicroTymp2 Printer/Charger also charges the rechargeable battery in the MicroTymp2 Handle.

This manual describes how to operate and maintain the MicroTymp2 Handle and Printer/Charger. Please follow these instructions to ensure many years of accurate and reliable service. For additional information on the science of tympanometry, refer to “A Guide to Tympanometry” (Appendix A, page A-25).

# MicroTympanometer 2 Handle Components

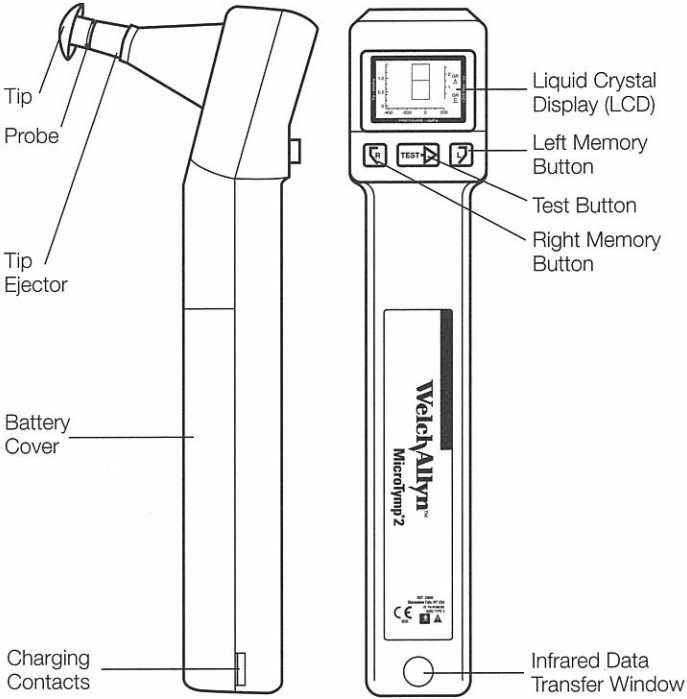


Figure 1A

# MicroTyp2 Printer/Charger Components

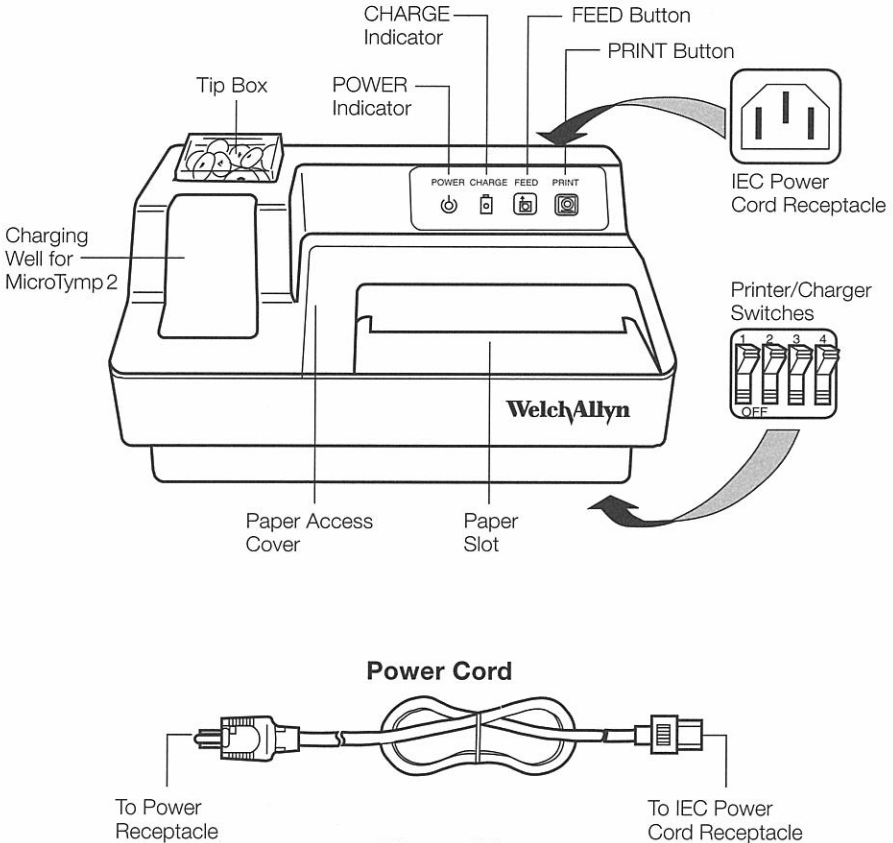


Figure 1B

## Preparing to Use the MicroTyp2 Handle and Printer/Charger

The following is a list of important facts to note before using the MicroTyp2.

- Please complete and return the warranty registration card. It validates the warranty, and allows Welch Allyn to communicate recalibration notices and software changes.

- If the MicroTymp 2 set has not been stored at room temperature, allow 45 minutes for it to return to operating temperature range (15-35°C or 59-95°F) before using.
- Do not store either the MicroTymp 2 Handle or Printer/Charger at temperatures which exceed 66°C (150°F). Continual exposure to extremely high temperatures can permanently damage components.



Refer to Operating Instructions manual.



**DANGER:** Explosion risk if Printer/Charger is used with flammable anesthetics.



**CAUTION:** Disassembly of the Printer/Charger presents a possible electrical shock hazard. Refer all servicing to Welch Allyn or a Welch Allyn authorized service representative listed on page E-55.



Disassembly of the MicroTymp 2 Handle or Printer/Charger beyond the extent described in this manual will void the warranty. Refer all servicing to Welch Allyn or a Welch Allyn authorized service representative listed on page E-55.



Disconnect from the mains via the appliance inlet.




Charge only MicroTymp 2 Handle (#23640), MicroTymp Handle (#23600), or AudioScope 3 (#23300) in the MicroTymp 2 Printer/Charger.



**BATTERY REPLACEMENT:** Replace with Welch Allyn model #72900 battery only.

**NOTE:** The MicroTymp 2 Printer/Charger will charge and print data from the original MicroTymp Handle. However, the original MicroTymp Printer/Charger will neither charge nor print data from the MicroTymp 2 Handle. A special AudioScope Charging Stand (#71126) is available for charging only.

## Setting up the MicroTymp 2 Handle and Printer/Charger

- Install the MicroTymp 2 rechargeable battery in the Handle by following the instructions found on page C-43 of this manual.
- Place the Printer/Charger on a flat, horizontal surface.
- Plug the power cord into the receptacle in the rear of the Printer/Charger. Then connect the power cord to a receptacle of proper voltage, frequency, and plug type. The green POWER  indicator will illuminate to indicate that the Printer/Charger is operating properly. See **Figure 1A and 1B** (pages 2 and 3).



# MicroTymmp2 – Completing a Test

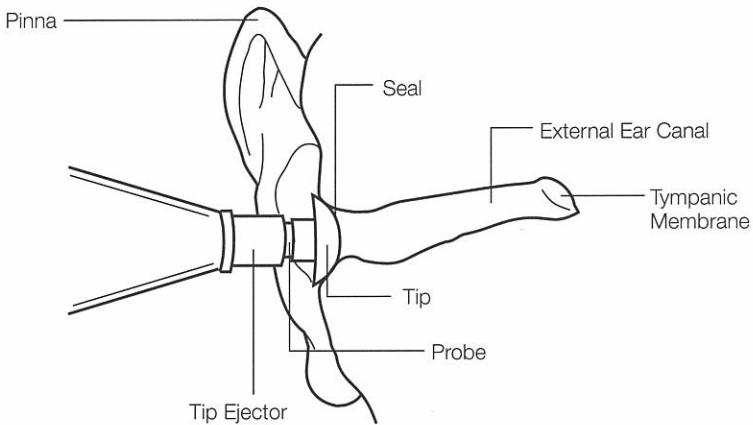
## Obtaining a Tympanogram

### Selecting a Probe Tip

1. After examining the subject's ear canal opening, select a tip which is large enough to seal the entrance of the ear canal. See **Figure 2**.

To change tips, either pull the tip off by hand or slide the tip ejector towards the tip.

**NOTE:** Tips are not intended to be deeply inserted into the ear canal. Using an improper tip size causes leaks, and will make it difficult to complete a test.



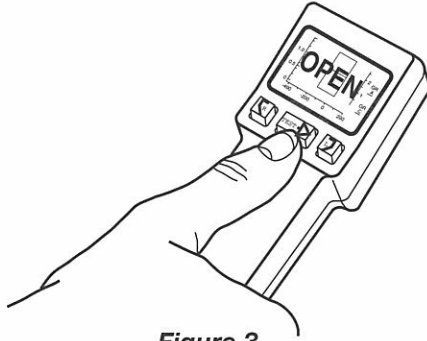
**Figure 2**

2. Push the tip onto the probe, making sure that the tip is fully seated.

---

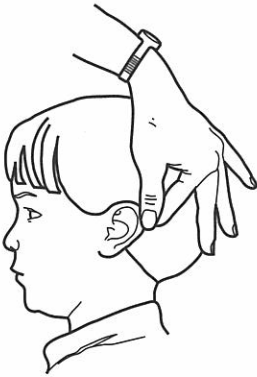
## Testing

3. Turn on the MicroTympanometer 2 Handle by pressing the TEST  button below the Liquid Crystal Display (LCD). The word "OPEN" appears on the LCD. **Figure 3** illustrates the TEST  button and the OPEN message.



**Figure 3**

**NOTE:** The MicroTympanometer 2 automatically turns off 15 seconds after the last test or activation of any button.



**Figure 4**



**Figure 5**

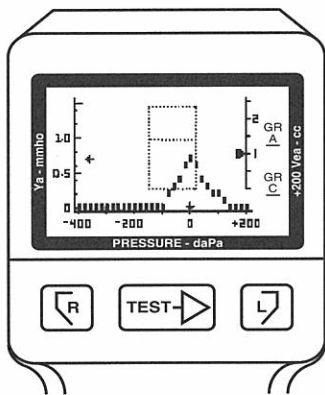
4. Grasp the subject's pinna. Pull gently back to straighten the child's ear canal (or up and back for adults). See **Figure 4**.
5. While maintaining tension on the pinna, press the tip firmly against the ear canal opening. See **Figure 5**. Point the tip straight into the ear canal for adults and slightly anteriorly for children.

**NOTE:** Due to changes in air pressure during a test, the subject will feel slight pressure in the ear canal. During the brief seconds when tympanometric measurements are made, it is important that the practitioner's hand is steady, and that the subject does not talk, yawn, chew gum, cry, or make any other similar movements.

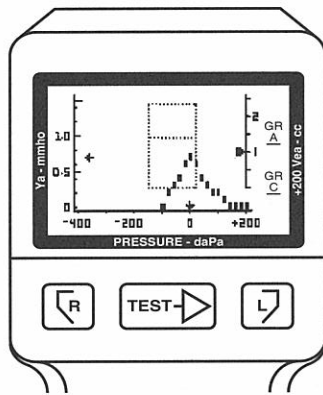
If a seal is not achieved, the LCD will display a LEAK, BLOCK, or OPEN message. Reposition the instrument to attempt another test.

6. Once a seal is achieved, the TEST message appears on the LCD, followed by the volume indication on the +200 Vea scale. Data points are then displayed from right to left across the LCD as the test progresses. If the BLOCK, LEAK, or OPEN messages appear during the test, reposition the tip to restart the test.

The test is complete when the last data point is displayed. **Figure 6A** illustrates the execution of a complete test (approximately 1.8 seconds). If patient or instrument movement causes a leak beyond -100 daPa, the test will be stopped (approximately 1.0 seconds), but the data will be saved. See **Figure 6B**.



**Figure 6A**

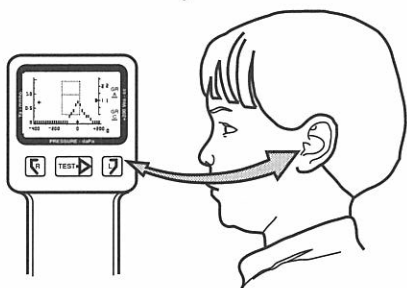


**Figure 6B**

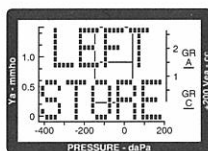
## Storing and Erasing Data

7. To store the results of the test, press the button which matches the tested ear, as illustrated in **Figure 7**.

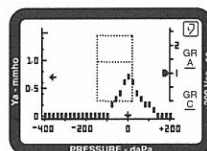
The memory buttons are labeled  $\boxed{R}$  for the right ear and  $\boxed{L}$  for the left ear. When test results are stored in memory, the RIGHT STORE or LEFT STORE message (see **Figure 7A**) appears momentarily on the LCD. Then the tympanogram which has been stored reappears along with the right  $\boxed{R}$  or left  $\boxed{L}$  symbol (see **Figure 7B**) to indicate the contents of that memory.



**Figure 7**



**Figure 7A**



**Figure 7B**

## Displaying Memory Contents

Information stored in memory may be recalled at any time by depressing the appropriate memory button.

## Erasing Memory Contents

There are two ways to erase memory contents:

- When a test is stored, the previous test is automatically erased.
- Depressing either the right  $\boxed{R}$  or left  $\boxed{L}$  memory button for more than three seconds erases that memory.

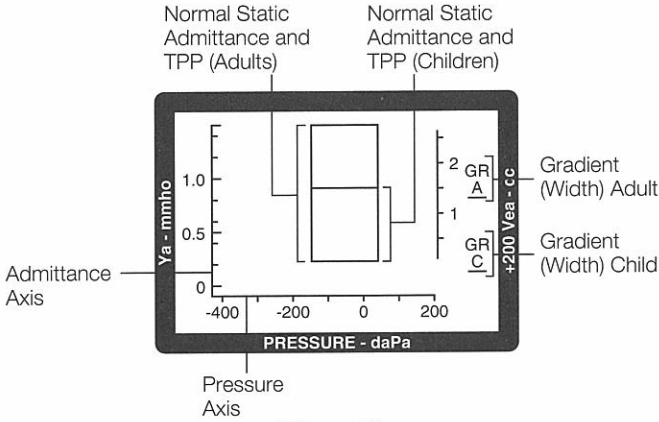
## Understanding the Liquid Crystal Display (LCD) and Its Messages

The following messages may be displayed on the LCD during MicroTympanometry 2 Handle operation:

### Gradient (Width) Measurements

When a tympanometric tracing is complete, the MicroTympanometry 2 measures the gradient or width of the tympanogram. If the gradient is abnormal, an asterisk will appear on the LCD under  $\overline{GR}_A$  for the adult's ear (greater than 10 years of age), or  $\overline{GR}_C$  for the child's ear (10 years of age or younger). For more information, see Appendix A, "Guidelines for Tympanometry", and Appendix B, "Guidelines for Screening".

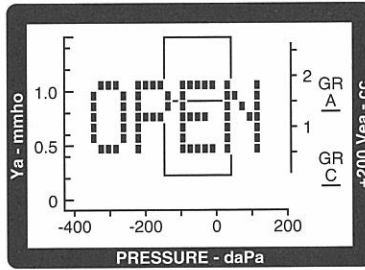
## LIQUID CRYSTAL DISPLAY



**Figure 8**

A sample of the Liquid Crystal Display is shown in **Figure 8**.

## OPEN



**Figure 9**

The test has not begun since a valid ear cavity has not been detected. The ear canal volume exceeds 2.5 cc.

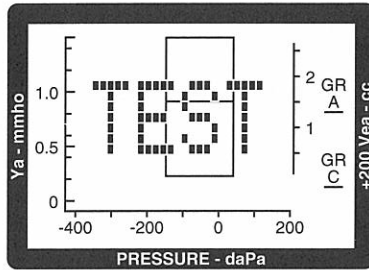
*Possible causes:*

- instrument is not in an ear
- probe tip is not completely sealed in an ear
- instrument is used on perforated tympanic membrane, an ear with patent tympanostomy tubes, or an extremely large canal (> 2.5 cc).

---

## TEST

---

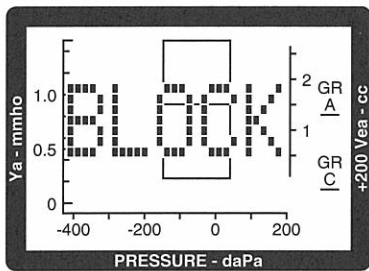


**Figure 10**

The TEST message indicates that the test has started. Immediately following this message, test data will begin to appear.

## BLOCK

---



**Figure 11**

The test cannot continue since the measured admittance is less than 0.2 mmho.

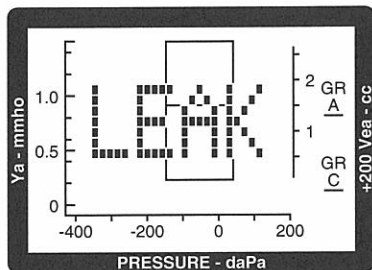
*Possible causes:*

- probe tip is lodged against canal wall
- ear canal occluded
- collapsed ear canal
- extremely small ear or tortuous canal
- probe tip is clogged with cerumen

*Possible solutions:*

- reposition the probe tip
- perform otoscopy to check for occlusion
- remove cerumen from probe tip

## LEAK



**Figure 12**

The test cannot proceed since desired pressures within the ear have not been achieved.

*Possible causes:*

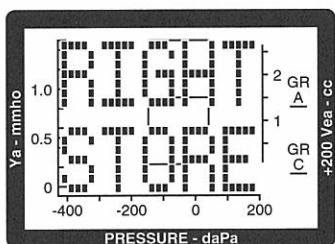
- probe tip is not completely sealed in the ear canal
- excessive movement of patient or practitioner
- probe tip dislodged during a test

*Possible solutions:*

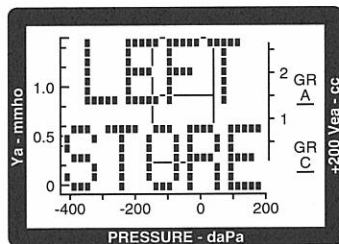
- reposition probe tip
- patient and practitioner must remain still
- use a different size probe tip
- increase pressure against the ear

If a leak condition occurs after -100 daPa pressure is reached, results will remain on the display. If an identifiable peak is displayed, the test need not be repeated. If no peak can be identified, repeat the test and try repositioning the tip, using a different size tip, or increasing the pressure against the ear canal opening.

## RIGHT STORE/LEFT STORE



**Figure 13A**



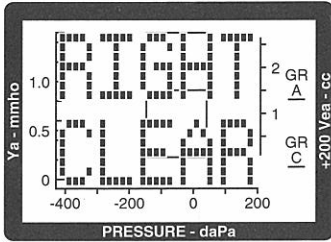
**Figure 13B**

Test results have been stored in the designated memory location. Immediately following this message, the newly-stored tympanogram reappears along with the right (R) or left (L) symbol. For instructions on storing and erasing data, see page 7.

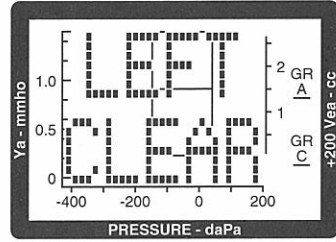
---

## RIGHT CLEAR/LEFT CLEAR



---



**Figure 14A**



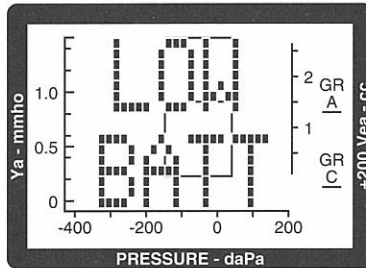
**Figure 14B**

The designated right  or left  memory location contains no data. Either no data has been stored, or previously stored data has been erased. See page 7 for information on storing and erasing data.

---

## LOW BATT(ery)

---



**Figure 15**

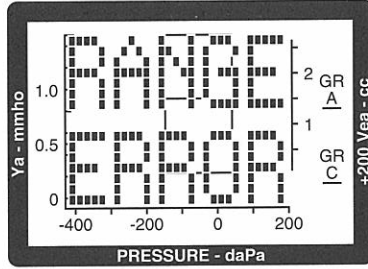
The LOW BATT message indicates that the battery needs to be recharged. All buttons are disabled to prevent inaccurate results due to inadequate battery voltage. Normal operation may be restored by recharging the battery or replacing the battery with a charged battery. Stored data is not lost when the battery is removed.

**NOTE:** The battery must be removed if the MicroTym2 Handle is to be stored or placed anywhere other than in the powered Printer/Charger for more than one month. Failure to do this can result in damage to the MicroTym2 Handle.


See Appendix C, "Maintaining the MicroTym2 Equipment," for instructions on removing and recharging the battery.



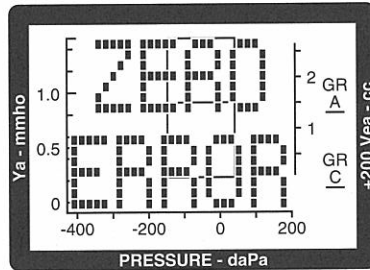
## RANGE ERROR




**Figure 16**

The RANGE ERROR message indicates that a large pressure change occurred during a test. If this message appears, press the TEST  button and start the test again.

## ZERO ERROR



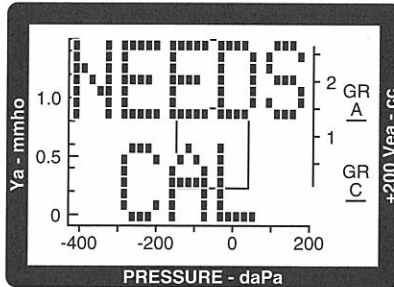
**Figure 17**

The ZERO ERROR message indicates that a large pressure change occurred during automatic pressure compensation at the start of a test. If this message appears, press the TEST  button and start the test again.

---

## NEEDS CAL(ibration)

---



**Figure 18**

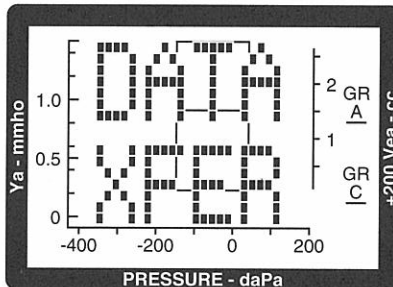
Something has caused the MicroTymp2 to fail an internal calibration test. All MicroTymp2 buttons have been disabled because the instrument needs to be returned to a Welch Allyn service location for calibration. Any results already stored in the handle may be printed.

Annual recalibration is recommended to insure instrument accuracy. See Appendix E, "Service and Warranty Information," for details on service locations and recalibration.

---

## DATA XFER(transfer)

---






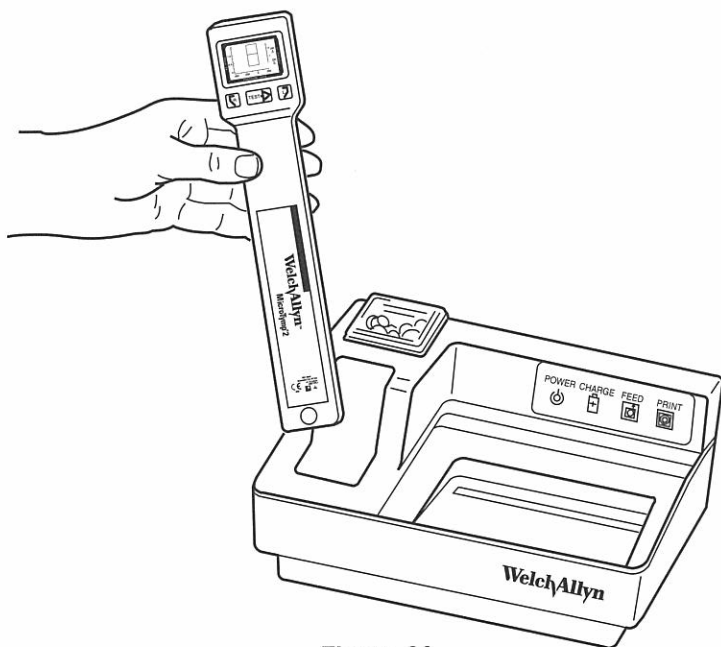
**Figure 19**

The data stored in the MicroTymp2 Handle is being transferred to the Printer/Charger.


## Printing Memory Contents

Follow the steps listed below to print tympanometric data stored in the MicroTymmp2 Handle:

1. Place the MicroTymmp2 Handle in the well with the Liquid Crystal Display (LCD) and buttons facing you. See **Figure 20**.  
When the MicroTymmp2 is properly seated in the well, the green CHARGE  indicator illuminates.
2. Press the PRINT  button.
3. To feed extra paper, press the FEED  button. Paper continues to feed as long as the button is depressed.



**Figure 20**

- 
4. To remove the printout, pull the paper forward and to the left or right to tear it along the cutting edge.
  5. To obtain an additional copy of the test results, leave the Handle in the well and press the PRINT  button again. Removing the MicroTymp2 Handle from the well causes the data to be removed from the Printer/Charger memory.

**NOTE:**

- The Printer/Charger has been pre-set at Welch Allyn to print a complete printout as illustrated in *Figure 21* on page 17, and to print in manual mode. To change formats or print in automatic mode, follow the instructions on page 20.
- If only one ear has been tested, the memory for the other ear should be erased (see page 8) so as not to confound current data with data from a previous patient.
- If only one memory location has data, only one result is printed.
- Do not use transparent adhesive tape on the printed portions of a printout, as those portions will then fade.

## MicroTymp2 Printout Formats

### Description of Formats

A complete tympanometric printout is shown in *Figure 21*. The printout is divided into three sections: tympanogram, data, and interpretive messages. Following is a detailed account of the information presented in each of these sections. For instructions on changing the format of the printout, see page 20.

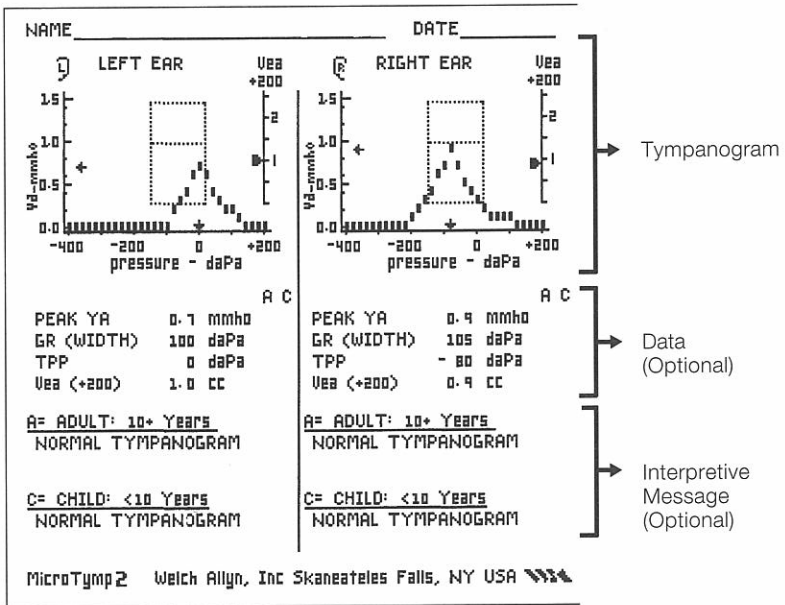


Figure 21

### Tympanogram Section of Printout

The tympanogram is a graph which records the admittance of the ear as a function of air pressure.

### Data Section of Printout

The data section displays numeric values for the four key characteristics of the tympanogram:

- **Peak Ya** — the compensated static acoustic admittance (height) of the peak, measured in acoustic millimhos (mmho).
- **Gradient (GR)** — the width of the tympanogram; the distance across the tympanogram measured at a height 50% down from the peak, measured in decapascals (daPa).
- **Tympanic Peak Pressure (TPP)** — where the tympanometric peak occurred on the pressure axis, measured in decapascals (daPa).
- **Volume of the Ear Canal (Vea)** — acoustically-determined ear canal volume, measured in cubic centimeters (cc) at +200 daPa.

If the numeric values are greater or less than the 90th percentile of the normative data for a child or an adult, an asterisk appears under the C(hild) or A(dult) column. The normative data are listed in **Table 1** below.

For some tympanometric results, no data will be printed. These occasions are:

- Peak Ya is greater than 1.5 mmhos. The message “High Peak Ya” will appear at the top of the tympanogram.
- Peak Ya less than 0.3 mmhos.
- Peak Ya which is incomplete; for example, a negative pressure tympanogram which is so far negative that the peak has not been reached and data are incomplete.
- Tympanogram has too much artifact. Artifact is generally caused by movement of the subject or the instrument.

**Table 1 — Normative Tympanometric Data**

<b>Tympanometric Measurement</b>	<b>Child’s Ear (Under Age 10) 90% Range</b>	<b>Adult’s Ear (Over Age 10) 90% Range</b>
Peak Ya	0.2 to 0.9 mmho	0.3 to 1.4 mmho
Gradient (GR) (Tympanometric Width)	60 to 150 daPa	50 to 110 daPa
Tympanometric Peak Pressure (TPP)	-139 to +11 daPa	-83 to 0 daPa
Equivalent Ear Canal Volume (Vea)	0.4 to 1.0 cc	0.6 to 1.5 cc

**NOTE:** For purposes of tympanometric norms, an adult is defined as a person 10 years of age or older, and a child as under age 10.

Normative data are taken from a study by Margolis and Heller (1987), and from the “Guidelines for Screening for Hearing Impairments and Middle Ear Disorders” ASHA (1990).

---

## Interpretive Messages Section of Printout

The interpretive messages section of the printout provides an interpretive, verbal description of the tympanometric result.

The computer in the Printer/Charger examines the data for clinically-significant deviations from the normal values. For example, a tympanogram which is too wide may be indicative of a developing or resolving otitis media; the message reads "Tympanogram Is Wide".

The hierarchy of messages displayed is as follows:

- Noisy Tympanogram (too much artifact near the peak)
- Low Peak Height, Small Ear Volume
- Low Peak Height, Normal Ear Volume
- Low Peak Height, Large Ear Volume
- Tympanogram Is Wide
- Negative Tympanometric Peak Pressure
- Positive Tympanometric Peak Pressure
- High Peak Height
- Normal Tympanogram

The computer scans the list of messages and prints the first message that applies. The hierarchy is arranged so that the most clinically-important message is displayed first.

### **FOR THOSE USING THE ORIGINAL MICROTYP HANDLE**

**NOTE:** The original MicroTymp Handle functions identically to the MicroTymp2 Handle with respect to printing. However, since the original MicroTymp's range is from +200 daPa to -300 daPa, no data points will print from -300 daPa to -400 daPa.

The Child Peak Ya limit on the original MicroTymp Handle is 0.2 to 0.8 mmho.

---

## Selecting Printout Formats

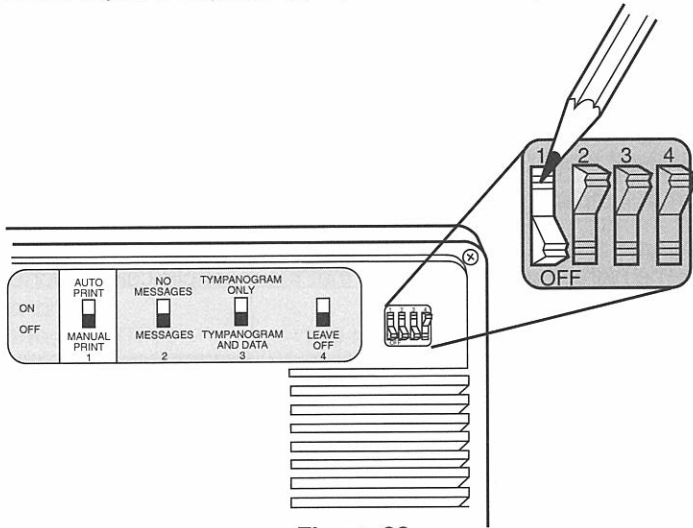
The four switches used to select the printout format and printer mode of operation are located on the bottom of the Printer/Charger. See **Figure 22**.

**NOTE:** Switch #4 is used during manufacturing only. If Switch #4 is ON, the Printer/Charger will not operate normally.

## Changing from Manual to Automatic Printout

Use Switch #1 to change from manual to automatic printout.

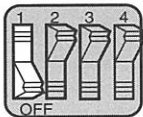
Use a pointed object to depress appropriate ON or OFF portion of the switch.



**Figure 22**

### Automatic vs. Manual Printout (Switch #1)

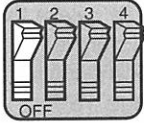
*Auto Print*





Depress the ON portion of the switch to select this option. This causes the printout to begin automatically once the MicroTymp Handle is placed in the well, and data transfer is complete.



*Manual Print*



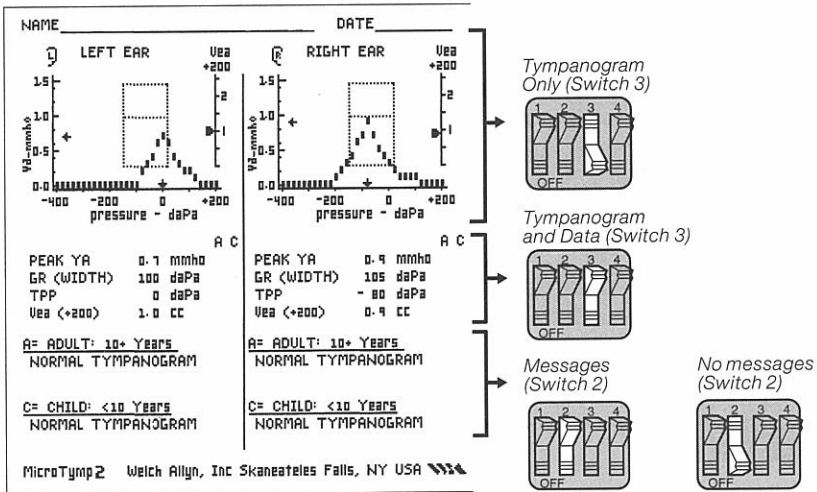
Depress the OFF portion of the switch to select this option. This causes the printout to begin only when the PRINT  button is depressed.

**NOTE:** In the manual mode, a beep will occur as a reminder that data has been transmitted; however, it is not necessary to wait for the beep before pressing the PRINT  button.

### Changing Printout Format

Use Switches #2 and #3, located on the bottom of the Printer/Charger, to change printout format. Printout options are shown in **Figure 23**.

Use a pointed object to depress appropriate ON or OFF portion of the switch.

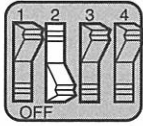


**Figure 23**

---

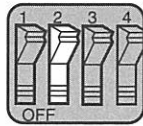
### Printing Interpretive Messages (Switch #2)

*No messages*



Depress the ON portion of the switch to select this option. This causes messages which interpret the tympanogram to not be included on the printout. Refer to Description of Formats on page 16 for more information on these messages.

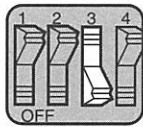
*Messages*



Depress the OFF portion of the switch to select this option. This causes the messages which interpret the tympanograms to be included on the printout.

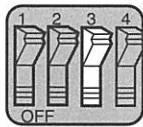
### Printing Tympanogram Only or Tympanogram and Data (Switch #3)

*Tympanogram Only*



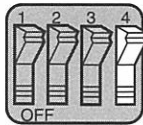
Depress the ON portion of the switch to select this option. Only the tympanogram and the GR (Width) numeric value will print.

*Tympanogram and Data*



Depress the OFF portion of the switch to select this option. Both the tympanogram and its corresponding numeric data will print.

### Manufacturing Switch (Switch #4)





This switch is used during manufacturing only. Leave this switch in the OFF position. The Printer/Charger will not operate normally if this switch is on.

## Printer Function Messages


If tympanometric results are not printed, a message will appear describing the reason. These messages are listed in **Table 2**.

**Table 2 – Printer Function Messages**

Printer Function Message	Possible Cause	Possible Solution
<b>No Data Reinsert Handle</b>	The MicroTymp Handle is not located in the well.	Seat the handle in the well.
	The MicroTymp Handle is not seated properly in the well.	Insure that the handle is fully seated in the well with the Liquid Crystal Display (LCD) and buttons facing you.
	The MicroTymp Handle has a discharged or missing battery.	Verify battery is in place, and charged (LOW BATT message does not appear).
	The MicroTymp Handle is not functioning properly.	Call your nearest Welch Allyn service location, distributor, or factory representative.
<b>No Data Nothing in Memory</b>	Both right  and left  memory locations in the MicroTymp Handle are empty.	Insure that data is being stored correctly. See page 7.
<b>Computer Interface Switch 4 is Set on Bottom of Printer</b>	Switch #4 on Printer/Charger is ON.	Turn switch #4 OFF. See page 22.

---


# Printer Service Codes

When the Printer/Charger is plugged into an electrical outlet, the green POWER  indicator illuminates and the instrument beeps to indicate that the printer is ready for use.

If a problem exists, the green POWER  indicator flashes. The number of flashes correspond to the specific problems listed in **Table 3**.

**Table 3 – Printer/Charger Flashing Indicators**

Number of Flashes	Problem	Solution
<b>One</b>	Printer/Charger is out of paper.	Replace paper. See page C-48 for instructions.
<b>Two</b>	Paper lever is in wrong (forward) position.	Return paper lever to its original, correct position. See page C-49 for instructions.
<b>Three or More</b>	System failure within Printer/Charger.	Verify that switch #4 is in the OFF position. Unplug the Printer/Charger. Wait one minute, then re-apply power to the instrument. If Printer/Charger does not return to normal operation, return it to the nearest Welch Allyn service location.

**NOTE:** If the green POWER  indicator is not illuminated, verify connection to live power source. If the problem persists, return the Printer/Charger to the nearest Welch Allyn service location.

# Appendix A

---

## Guide to Tympanometry

Aural acoustic immittance measurements have become an integral component of audiologic and otologic evaluation. One class of aural acoustic immittance measurement, tympanometry, has become routine in the assessment of ear disease. Since the original report of Terkildsen and Thomsen (1959), tympanometry has been used widely by physicians and audiologists as a research tool for studying the effects of ear disease on middle ear function and as a clinical test for detecting medically-significant pathology. Recent technological advances have paved the way for MicroTym2, a low-cost, portable, precision instrument that can be of significant value for determining the need for medical referral, for diagnosis of ear disease, and for monitoring the course of medical/surgical intervention.

The Welch Allyn MicroTym2 is a single-component, aural acoustic admittance meter that records a tympanogram with a 226-Hz probe tone.

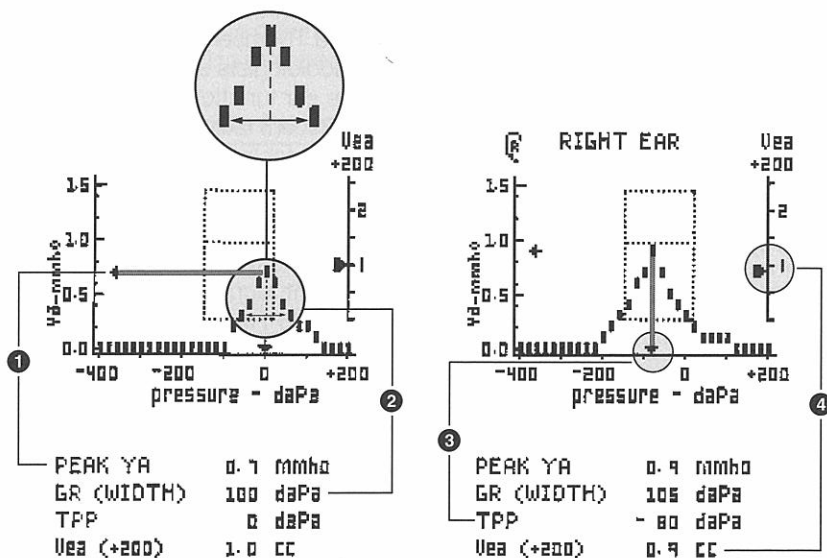
### Basic Principles of Tympanometry

Acoustic admittance is the ease with which acoustic energy is transferred from one system to another. If the air in the ear canal is easily set into vibration, the admittance is high. If the air is difficult to set into vibration, the admittance of the system is low. The ease or difficulty of setting the air in the ear canal into vibration is determined by the volume of air and the admittance of the middle ear. Tympanometry provides a method of evaluating the physical characteristics of the ear canal/middle ear system by measuring the admittance of the air trapped in the ear canal.

Tympanometry is the measurement of acoustic admittance as a function of ear canal air pressure. The resulting graph is a tympanogram. Because ear canal air pressure changes the admittance of the middle ear, the admittance of the air in the ear canal changes when the ear is pressurized. Positive or negative pressure, introduced into the sealed ear canal, decreases the admittance of the air in the ear canal by stiffening the eardrum. The effect of air pressure on the acoustic admittance measured in the ear canal is systematically altered by ear disease. Tympanometry is a sensitive indicator of the effects of ear disease on the acoustical and mechanical function of the middle ear.

## Tympanogram Characteristics

**Figure 24** illustrates a MicroTympt2 tympanogram. A description of the key characteristics of the tympanogram follows.

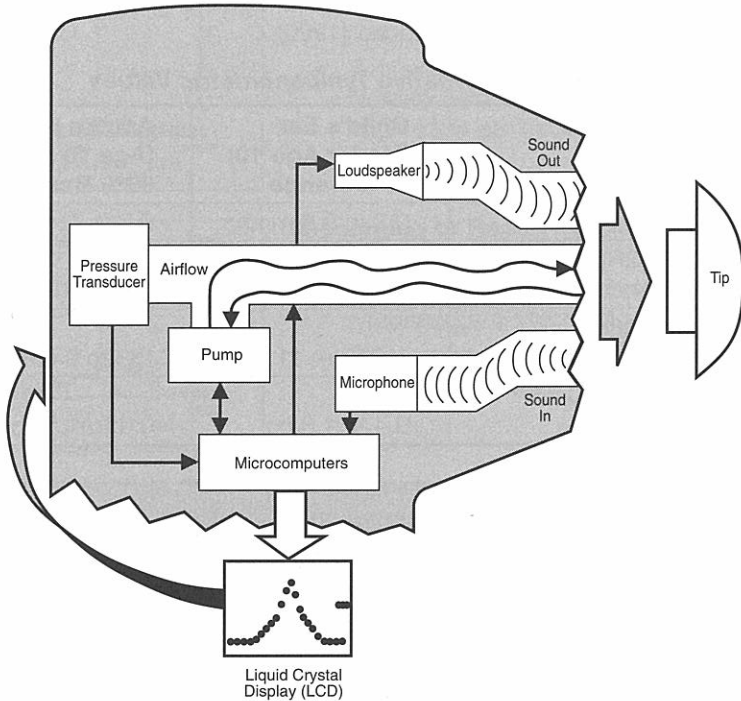


**Figure 24**

- ❶ **Static Admittance (Peak Ya)** is a measure of the height of the tympanometric peak. Given appropriate normative values, static admittance is a useful indicator of middle ear disease.
- ❷ **Tympanometric Gradient (GR)**, or tympanometric width, is a measure of the width of the tympanometric peak. Defined as the width of the tympanogram (in decapascals) at 50% of peak eardrum admittance, tympanometric width is a good indicator of the presence of middle ear effusion.
- ❸ **Tympanometric Peak Pressure (TPP)** is the position of the tympanometric peak on the pressure axis. TPP is an imprecise measure of the middle ear pressure. By itself, TPP is not an accurate indicator of middle ear disease.
- ❹ **Equivalent Ear Canal Volume (+200 Vea)** is the admittance value determined with an ear canal air pressure of +200 daPa (decapascals). A flat tympanogram with an abnormally-high equivalent ear canal volume suggests the presence of a tympanic membrane perforation or a patent tympanostomy tube.

## How the MicroTym 2 Instrument Works

A block diagram of a Welch Allyn MicroTym 2 is illustrated in **Figure 25**.



**Figure 25**

A 226-Hz probe tone is introduced into the sealed ear canal by a miniature loudspeaker. A miniature microphone records and monitors the sound pressure produced in the ear canal.

The sound level is maintained at a constant 85 dB SPL (Sound Pressure Level) throughout the test by a microcomputer. When the amount of sound absorbed by the middle ear increases, the speaker is driven harder by increasing the drive voltage to maintain the constant SPL. The voltage required to maintain the probe tone at 85 dB SPL is proportional to the acoustic admittance of the ear.

Air pressure in the ear canal is changed with a miniature pump. The pressure transducer monitors air pressure, feeding this information to another microcomputer so that it can control the rate of pressure change (sweep rate).

As pressure in the ear canal is changed throughout a test, a microcomputer computes acoustic admittance and plots admittance as a function of pressure on the liquid crystal display.

## Normative Values for the MicroTymp 2

The normative values listed in **Table 4** are taken from a study by Margolis and Heller (1987), and from the “Guidelines for Screening for Hearing Impairments and Middle Ear Disorders” (1990).

**Table 4 — Normative Tympanometric Values**

Tympanometric Measurement	Child’s Ear (Under Age 10) 90% Range	Adult’s Ear (Age 10 & Over) 90% Range
Peak Ya	0.2 to 0.9 mmho	0.3 to 1.4 mmho
Gradient (GR) (Tympanometric Width)	60 to 150 daPa	50 to 110 daPa
Tympanometric Peak Pressure (TPP)	-139 to +11 daPa	-83 to 0 daPa
Equivalent Ear Canal Volume (Vea)	0.4 to 1.0 cc	0.6 to 1.5 cc

**NOTE:** For purposes of tympanometric norms, an adult is defined as a person 10 years of age or older, and a child as under age 10.

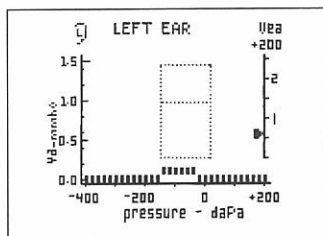
As the altitude above sea level increases, the admittance of a given volume of air also increases. Therefore, equivalent ear canal volume (+200 Vea) overestimates actual ear canal volume as noted in **Table 5**. To estimate ear canal volume, subtract the appropriate value in **Table 5** from the MicroTymp 2 Vea Reading. Altitude can also affect MicroTest Cavity results. Refer to Appendix D, “Functional Checks of the MicroTymp 2 Handle and Printer/Charger.”

**Table 5 — Altitude Adjustments for Vea Readings**

Altitude	Adjustment for 0.5 cc	Adjustment for 1.0 cc	Adjustment for 1.5 cc	Adjustment for 2.0 cc
1280 ft (390 m)	0.0 cc	0.0 cc	0.0 cc	0.1 cc
2530 ft (770 m)	0.0 cc	0.1 cc	0.1 cc	0.2 cc
3220 ft (980 m)	0.0 cc	0.1 cc	0.2 cc	0.3 cc
4757 ft (1450 m)	0.1 cc	0.2 cc	0.3 cc	0.4 cc

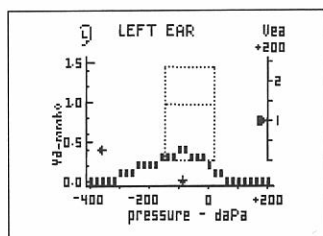


## Interpreting Tympanogram Results



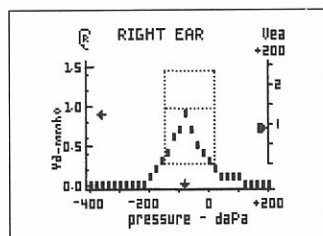
### Otitis Media with Effusion

- Produces low static admittance (low peak height) tympanogram
- Tympanogram is also typical of tympanosclerosis, cholesteatoma, and middle ear tumor



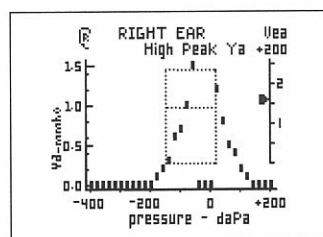
### Oncoming or Resolving Otitis Media with Effusion

- Produces normal peak height, but tympanogram which is too wide
- Tympanogram is also typical of tympanosclerosis



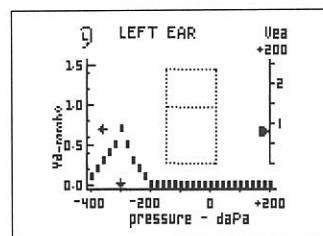
### Normal Middle Ear

- Produces tympanogram within normal limits relative to height and width



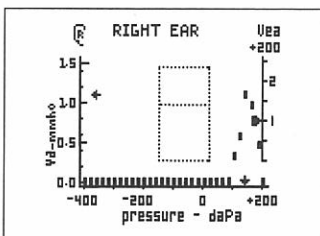
### Tympanic Membrane Abnormalities or Ossicular Disruption

- Produces high static admittance (high peak height) tympanogram



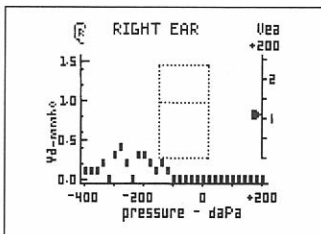
### Negative Middle Ear Pressure

- Produces negative Tympanometric Peak Pressure (TPP) tympanogram
- Usually not associated with effusion when Peak Ya is normal
- Also associated with eustachian tube dysfunction, cold, or allergies



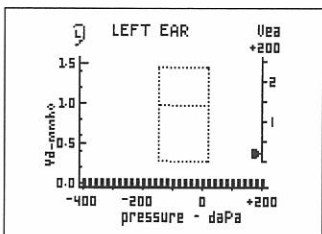
### Positive Middle Ear Pressure

- Produces positive Tympanometric Peak Pressure
- Indicative of acute otitis media, if peak is extremely positive



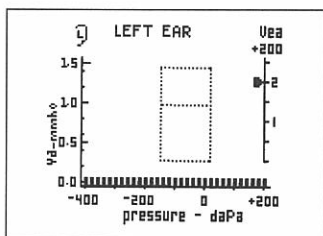
### Tympanogram with Too Much Artifact

- Caused by patient or practitioner movement
- Requires repeating measurement



### Ear Canal Occlusion

- Can produce flat tympanogram with ear canal volume lower than expected
- May also produce BLOCK message
- Requires repeating measurement



### Patent Tympanostomy Tube or Perforated Tympanic Membrane

- Can produce flat tympanogram with ear canal volume higher than expected
- May also produce OPEN message

## Obtaining a Valid Tympanogram

Tympanometric results, although accurate and objective, do require careful interpretation in conjunction with the patient's overall clinical condition.

In addition, there are conditions which can cause artifact such that a tympanogram is uninterpretable, or which artificially flatten the tympanogram. These conditions are described in more detail below.

If too much artifact is noted, or if a flat tympanogram is considered suspect, it is recommended that the tympanometric measurement be repeated.

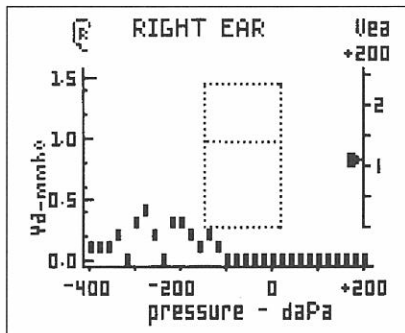
Indeed, it maybe good clinical practice to repeat all clinical measurements whenever possible.

## Tympanometry in Young Infants

Research from the 1980s suggests that tympanometry should not be performed on infants aged six months or younger. More recent research suggests that it is appropriate to use 226 Hz tympanometry (e.g., MicroTym2) on infants as young as four months of age (Holte, 1990 and 1991).

## Conditions Which Cause Too Much Artifact

Artifact is generally caused by either patient or practitioner movement. See **Figure 26**. During the brief seconds when tympanometric measurements are obtained, it is important that the practitioner's hand is steady, and that the patient does not vocalize, talk, chew gum, yawn, cry, or make any other similar movements. While this can be difficult with very young children, it is now more achievable than ever with the tremendous speed of MicroTym2 tympanometry.

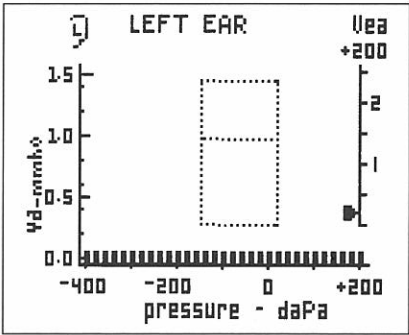


**Figure 26 – Too Much Artifact**

## Conditions Which Artificially Flatten the Tympanogram

In order to measure the mechanical properties of the middle ear, a tympanometric device must be capable of changing the pressure differential across the eardrum. Any occlusion of the ear canal, such as impacted cerumen, foreign body, tumor, stenosis, atresia, or a pocket created by the incorrect placement of the probe, can prevent this pressure differential from happening and can artificially flatten the tympanogram.

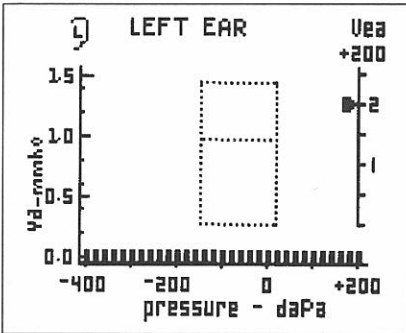
The result is that the volume of air in front of the probe will be very small. The MicroTympanometer will display the occurrence of this condition with the BLOCK message if the volume is less than 0.2 cc. However it is possible to obtain a flat tympanogram with a smaller than expected ear canal volume (less than 0.4 cc for children or less than 0.6 cc for adults), as shown in **Figure 27**.



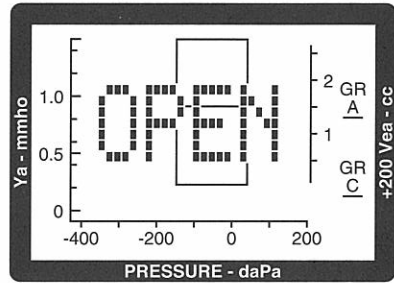
**Figure 27 – Ear Canal Occlusion**

## Patent Tympanostomy Tube or Perforated Tympanic Membrane

In the case of a tympanic membrane perforation or a patent tympanostomy tube, the air pressure produced by the MicroTym2 Handle escapes through the perforation or tube so that a pressure differential across the eardrum does not occur. Because the air pressure changes have no effect on the tension of the eardrum, the tympanogram is flat with an unusually high equivalent ear canal volume. If the volume exceeds 2.5 cc, the MicroTym2 Handle will not record a tympanogram at all, and the OPEN message will appear. See **Figure 28**.



*Flat Tympanogram  
with too High Volume*

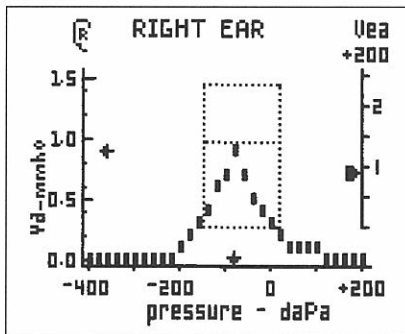


*Persistent OPEN  
Message (can't seal ear)*

**Figure 28**

## The Normal Ear

An example of a tympanogram from a normal ear is depicted in **Figure 29**.



**Figure 29**

## Low-Admittance Pathologies: Otitis Media with Effusion, Middle Ear Tumor, Ossicular Fixation, Tympanosclerosis

Low static admittance of the middle ear is produced by space-occupying lesions in various ways. A lesion that displaces air in the middle ear space causes low admittance by reducing the middle ear volume. The lesion also may interfere with the vibration of the ossicular chain, contributing to the low admittance. If the lesion is in contact with the eardrum, low admittance results from interference with eardrum vibration.

### Otitis Media with Effusion (OME)

Tympanometric characteristics of patients with OME typically include one or more of the conditions illustrated in **Figure 30**. In advanced cases, OME results in flat tympanograms (low static admittance). In intermediate stages of OME, the peak height may be normal, but the gradient may be too wide.

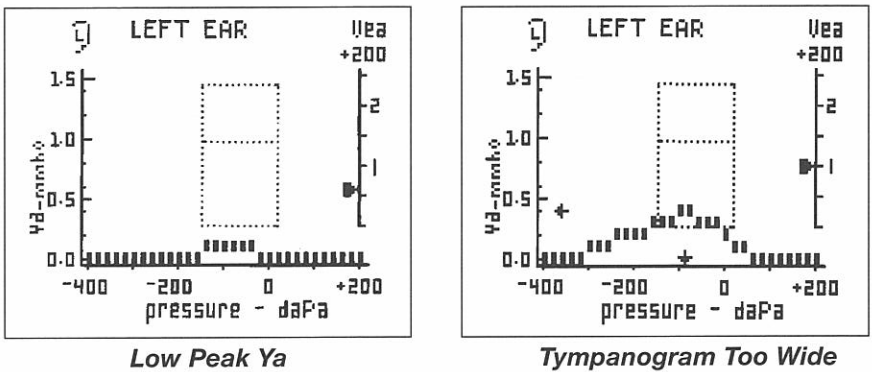


Figure 30

---

## **Middle Ear Tumor**

A wide variety of neoplastic processes exist that invade the middle ear. The most common is the keratoma (cholesteatoma), a collection of keratinizing squamous epithelium that frequently originates from Shrapnel's membrane (pars flaccida) of the tympanic membrane or the ear canal wall and invades the middle ear space. Other middle ear tumors include the cholesterol granuloma, glomus tumor, and squamous cell carcinoma (Goodhill, 1979). These pathologies generally result in a flat tympanogram.

## **Lateral Ossicular Fixation**

Lateral ossicular fixation may result from tympanosclerosis, a complication of chronic otitis media that may involve the eardrum, malleus, incus, and/or stapes. In general, the more lateral the fixation, the more effect the condition has on the tympanogram. Lateral fixations typically cause low static admittance and wide tympanometric widths.

## **Otosclerosis**

Because the otosclerotic lesion is more medial than lateral ossicular fixation, the tympanogram is less affected. The tympanometric shape is often indistinguishable from normal, although the static admittance may be slightly low and the tympanometric gradient (width) may be narrower than the normal tympanogram.

---

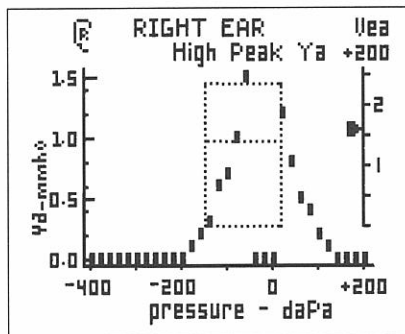
## Tympanic Membrane Abnormalities

### “Floppy” Tympanic Membrane

The tympanic membrane is normally a stiff, conically-shaped structure that derives its stiff characteristic from the lamina propria, a layer of connective tissue that is situated between the outer layer of squamous epithelium (skin) and the inner layer of mucous membrane. When the eardrum heals after a relatively large perforation, the lamina propria may be absent or thin in the region of the scar. This neomembrane can be set into vibration with greater ease than the normally-stiff tympanic membrane. The result is a high static admittance. See **Figure 31**. Although the tympanogram is abnormal, this condition rarely affects hearing sensitivity or requires further medical treatment.

### Ossicular Disruption

Disruption of the ossicular chain can range from partial interruption to complete absence of the ossicles. These conditions result from the erosive effects of chronic infection, trauma, and congenital defect. Ossicular disruption is usually associated with a substantial conductive hearing loss. Because the ossicles normally “load” the eardrum, contributing to its tension, the eardrum in an ear with ossicular disruption can be more easily set into vibration than the normal eardrum, resulting in high static admittance. See **Figure 31**.



**Figure 31 – High Static Admittance**

**NOTE:** When peak admittance exceeds 1.5 mmho, data points will be plotted at baseline (0.0 mmho). See **Figure 31**.



## Conditions Which Cause Negative Middle Ear Pressure

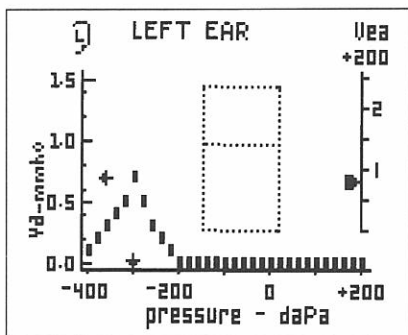


Figure 32

Negative pressure within the middle ear space will produce a tympanogram with a negative tympanometric peak. Some degree of negative pressure is normal (see normal TPP values listed in Table 1 on page 18). Negative middle ear pressure often accompanies a cold or allergies, or can be a result of eustachian tube dysfunction. Negative middle ear pressure is not usually associated with effusion when peak  $Y_a$  is normal.

## Conditions Which Cause Positive Middle Ear Pressure

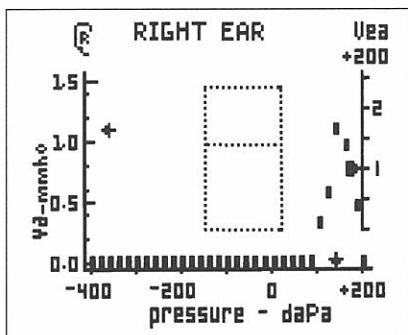


Figure 33

Positive pressure tympanograms reflect positive pressure in the middle ear space. A positive Tympanometric Peak Pressure (TPP) can be indicative of acute otitis media, but only if the tympanometric peak is extremely positive.



# Appendix B

---

## Guidelines for Screening for Hearing Impairments and Middle Ear Disorders

In a non-medical setting, tympanometry can be useful in determining the need for a medical referral. However, abnormal tympanometric results occur not only in patients with ear disease that requires medical attention, but also in subjects with transient conditions that resolve without medical intervention and in ears that have residual effects of previously-controlled disease. Consequently, it is unwise to base the decision of a medical referral on tympanometric results alone. Screening protocols that have based medical referrals on tympanometric results alone have resulted in an excessively high over-referral rate (Margolis and Heller, 1987).

Portions of the recommended screening protocol, published by the American Speech-Language-Hearing Association (ASHA) in 1990, for determining the need for medical referral are reproduced on pages B-40 to B-42. The guidelines are represented in a flow chart in **Figure 34**.

Appendix B

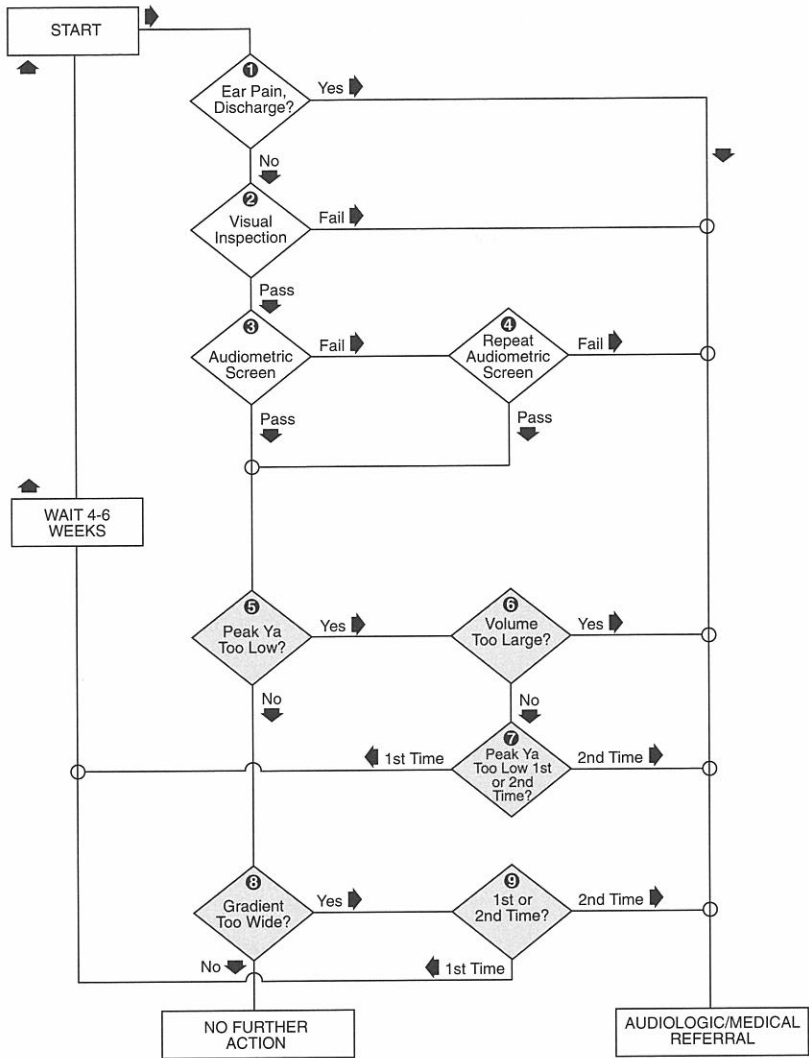


Figure 34

---

## Recommended Screening Protocol

The recommended screening protocol is based on a four-part procedure consisting of case history, visual inspection, pure-tone audiometry, and tympanometry. These guidelines can be used for all ages, however, they are designed specifically for children and young adults (through age 40). Referral criteria are presented in **Table 6** on page B-42. These criteria may require alteration for various clinical settings and populations.

The protocol is presented in flow chart format in **Figure 34**. The flow chart is a representation of the logic used to determine the need for referral. It does not represent the order in which test procedures are administered. With the exception that visual inspection should precede tympanometry, the order of test procedures is unimportant. The screening protocols described must be supervised by a clinical audiologist. Each test component, indicated by a numbered box in **Figure 34**, is described below:

- ❶ A recent, otologic history of otalgia or otorrhea is sufficient cause for immediate medical referral.
- ❷ Visual inspection of the ear may produce sufficient cause for medical referral without the need for further testing. Referral criteria include: structural defect of the ear, head, or neck; inflammation, blood, effusion, excessive cerumen, tumors, or foreign body in the ear canal; or eardrum appearance consistent with active middle-ear disease. When visual inspection indicates the need for medical referral, tympanometry is not necessary. When visual evidence of middle ear infection is present, or when a pressure-equalization tube is in place, tympanometry should not be performed unless requested by a physician.
- ❸❹ Audiometric screening should be performed by the method described in the *ASHA Guidelines for Identification Audiometry* (ASHA, 1985). Those guidelines recommend screening with pure-tone stimuli presented at 20 dB HL (re: ANSI S3.6-1989) with frequencies of 1000, 2000, and 4000 Hz. Failure to respond to any frequency constitutes failure of the audiometric screen. In accordance with the Identification Audiometry Guidelines, failure of the audiometric screen should be confirmed by a rescreen, either on-site or by additional testing at a later date. If the audiometric screen is failed on the second administration, a complete audiologic evaluation should be performed.
- ❺❻ Low static admittance (Peak Y [Ya]) associated with an abnormally-large volume in front of the probe is evidence of a tympanic membrane perforation and warrants immediate referral. The presence of (Vec [Vea]) (estimated at 200 daPa) exceeding the 90% range listed in **Table 6** on page B-42, and in the presence of a flat tympanogram is evidence of a large volume and should result in a medical referral.

- ⑦ Low static admittance (Peak Y [Ya]) may or may not be associated with significant middle ear disorders. In the absence of other positive findings, a Peak Y (Ya) below the 90% range listed in **Table 6** requires observation over an extended period before a medical referral is warranted. Only after two successive abnormal findings over an interval of 4-6 weeks should medical referral be made.
- ⑧⑨ An abnormally-wide tympanometric width (TW) may occur in the absence of other findings in cases with otitis media. These cases may represent transient secretory otitis media, which does not require medical referral. Like static admittance, abnormal TW in the absence of other signs of middle ear disorders requires a retest after 4-6 weeks, and only then should a medical referral be based on this finding alone.

## Audiologic or Medical Referral

Failure of the screen should result in an audiologic evaluation and medical examination. The nature of the referral may depend upon the characteristics of the screening program and the availability of services. For example, the referral may be to a clinic that provides both audiologic and medical services. Alternatively, an audiologic referral may precede the medical referral. If audiologic services are not available, an immediate medical referral should be made upon failure of the screening protocol.

**Table 6**

	Peak Y [Ya] (mmho or cm <sup>3</sup> )		Vec [Vea] (cm <sup>3</sup> )		TW (daPa)	
	Mean	90% Range	Mean	90% Range	Mean	90% Range
Children	0.5	0.2 to 0.9	0.7	0.4 to 1.0	100	60 to 150
Adults	0.8	0.3 to 1.4	1.1	0.6 to 1.5	80	50 to 110

# Appendix C

## Maintaining the MicroTymp 2 Equipment

### The MicroTymp 2 Battery

The MicroTymp 2 rechargeable nickel-cadmium battery is intended for many charge/discharge cycles and is warranted for two years. The warranty expiration date is imprinted on the battery.



**BATTERY REPLACEMENT:** Replace with Welch Allyn model #72900 battery only.



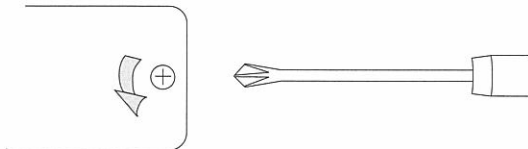
**NOTE:** This instrument contains components which are static sensitive. Before touching any internal handle component, be sure that you have discharged any static electricity by touching a grounded metal object.



**NOTE:** Disassembly of the MicroTymp 2 beyond the extent described in this manual will void the warranty. Refer all servicing to Welch Allyn or a Welch Allyn Authorized Service Representative listed on page E-55.

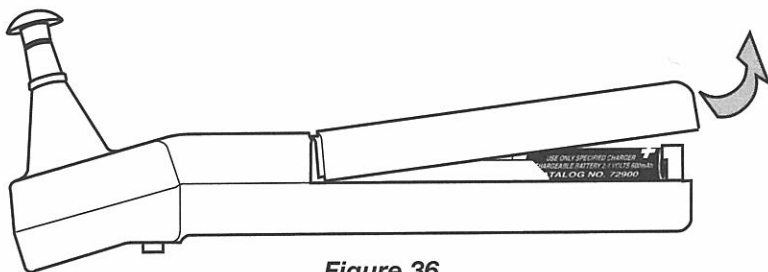
Replace the battery by following these steps:

1. Allow the MicroTymp 2 Handle to turn off.
2. Unscrew the battery cover in a counterclockwise direction using the #0 Phillips head screwdriver provided. See **Figure 35**. Save the screw.



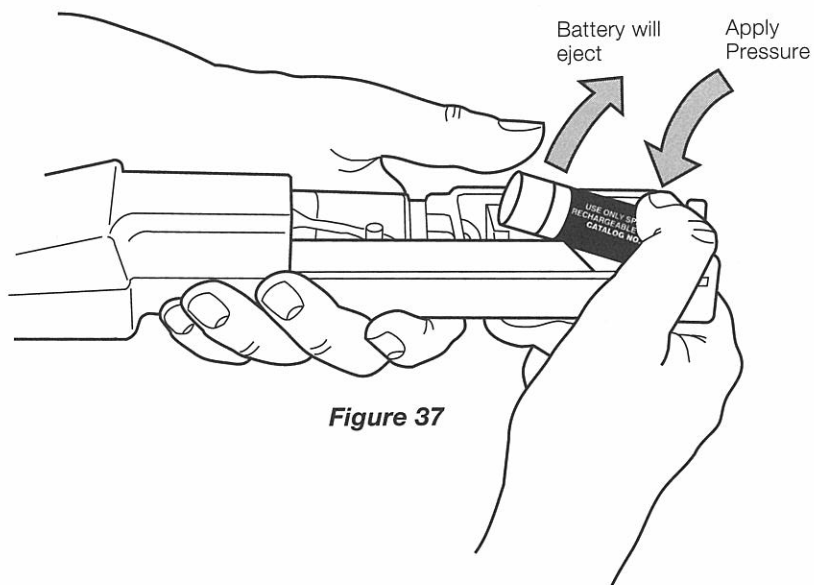
**Figure 35**

- 
3. Remove the battery cover by lifting the bottom of the cover away from the probe tip. See **Figure 36**.



**Figure 36**

4. Push down on the positive (+) end of the battery. Battery will eject. See **Figure 37**.

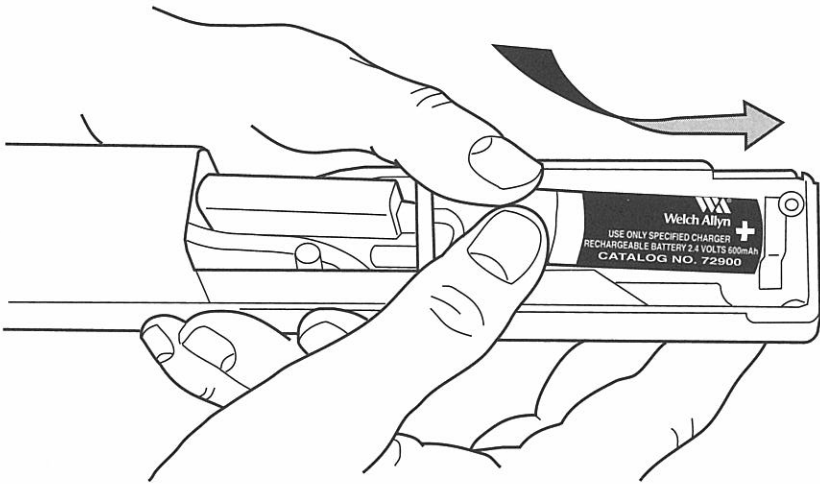


**Figure 37**



- 
5. Insert the replacement battery by placing the positive (+) end of the battery against the spring in the holder. Push the battery lightly to compress the spring, and lower the battery into the compartment. See **Figure 38**.

**NOTE:** Insert the battery only as shown. Failure to observe the correct polarity will prevent the instrument from functioning.



**Figure 38**

6. Replace the cover by inserting the tip end under the front cover, lowering the opposite end, and replacing the screw.
7. Tighten screw in clockwise direction. To avoid stripping the screw threads, do not tighten excessively.

---

## Recharging the Battery

To recharge the MicroTymp2 battery, place the MicroTymp2 Handle in the Printer/Charger well with the LCD and buttons facing you. See **Figure 39**.



**NOTE:** Charge only with the MicroTymp2 Printer/Charger (#71170, #71175) or special AudioScope Charging Stand (#71126).

The 2.4 V nickel-cadmium battery used in the MicroTymp2, when fully charged, provides a full day of operation without the need for recharging — yielding a minimum of 300 double ear tests. This makes the MicroTymp2 instrument optimal for mass screening or off-site situations where there may not be a need to print, but there is a need for continuous operation.

The LOW BATT message will appear on the LCD when the battery voltage is too low to provide reliable operation. All buttons are automatically disabled when the battery is low to prevent inaccurate results due to inadequate battery voltage. However, results which were previously stored may be recalled or printed when the battery is recharged or replaced.

A fully drained battery should be recharged overnight (14-16 hours).

### **NOTE:**

- The MicroTymp2 Handle may be charged indefinitely without damage to the battery.
- Slight heating of the MicroTymp Handle during charging is normal.
- The battery must be removed if the MicroTymp2 Handle is going to be stored or placed anywhere other than in the powered Printer/Charger for more than one month. Failure to do this can result in damage to the battery and to the instrument.
- The battery will self-discharge gradually over a period of approximately 60 days when stored at room temperature (70°F/21°C); storage at higher temperatures accelerates the discharge rate.

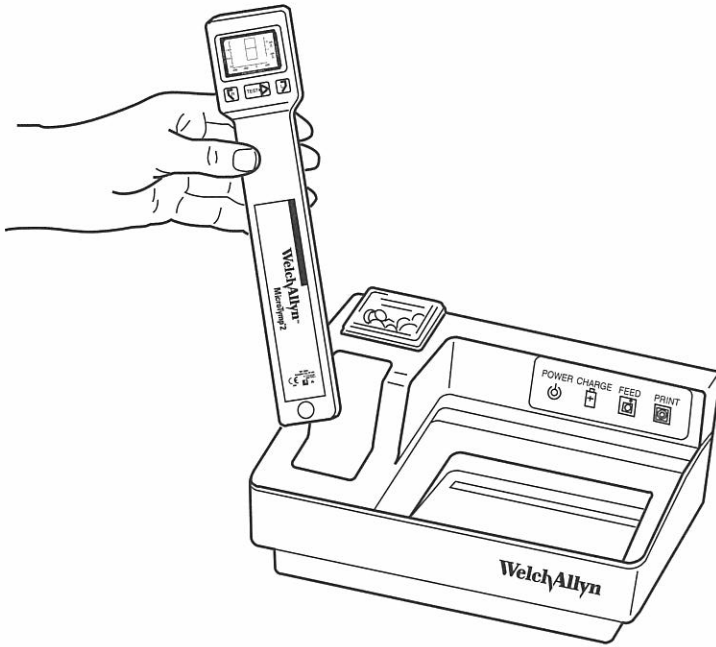


Figure 39

## Recycling the Battery

### Recycling Nickel-Cadmium Batteries (North America Only)

Welch Allyn employs the services of an agency which can disassemble and recycle all components of nickel-cadmium batteries so that nothing gets placed in a landfill or incinerated. To recycle an expended Welch Allyn rechargeable battery, please send to:

#### Welch Allyn

#### RECYCLE BATTERY

4341 State Street Road  
Skaneateles Falls, NY 13153-0220

#### Welch Allyn Canada

#### RECYCLE BATTERY

160 Matheson Blvd. East, Unit 2  
Mississauga, Ontario  
CANADA L4Z 1V4




Nickel-Cadmium Battery.  
Must be Recycled or  
Disposed of Properly.

---

## Paper Replacement

The MicroT ymp 2 Printer/Charger signals the need for changing the paper in one of two ways:

- A pink strip appears along the edge of the paper indicating the paper is nearing the end of the roll.
- The POWER  indicator flashes in single pulses indicating that there is no paper, and no printing can occur.

### NOTE:

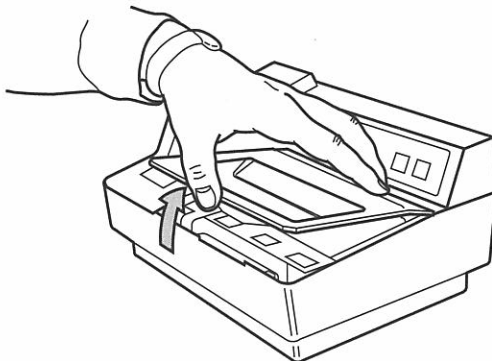
- Use only an appropriate heat-sensitive paper or the Printer/Charger life may be shortened and the warranty voided.
- The paper is thermally activated, so it must be stored in a cool, dark location to prevent exposure and degraded performance.
- Because the paper is thermally activated, no printing will appear on the paper if it is inserted backwards.
- Do not use transparent adhesive tape on printed portions of the printout, as those portions will then fade.

## To Replace the Paper




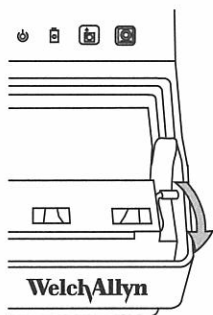
**CAUTION:** Disassembly of the Printer/Charger presents a possible electrical-shock hazard. Refer all servicing to Welch Allyn or a Welch Allyn authorized service representative, listed on page E-55.

1. Remove the paper access cover by pulling up on the front edge. See **Figure 40**.

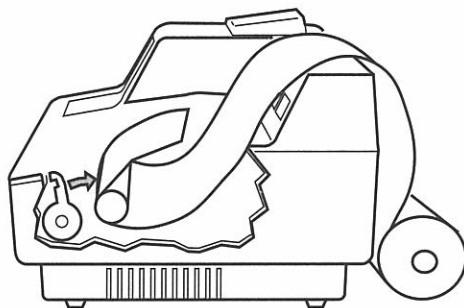


**Figure 40**


2. Depress the FEED  button to advance any remaining paper through the printer. *Do not pull paper backwards through the printer.* Remove and discard old paper roll, saving the black spindle.
3. Pull the paper lever forward. See **Figure 41**.



**Figure 41**



**Figure 42**

4. Place the roll of paper behind the Printer/Charger for easier handling.
5. Insert the paper (from the bottom of the roll) into the slot under the pinch roller, making sure that the paper is centered. See **Figure 42**.
6. Return the paper lever to its original position, and press the FEED  button to advance several inches of paper beyond the pinch roller.
7. Tighten the paper on the paper roll, reinsert the black spindle through the roll, and place the paper roll in the paper cradle.
8. Feed the paper through the slot in the paper access cover.

**NOTE:** Make sure that the paper is taut before replacing the paper access cover. Loose paper can cause printer malfunction.

9. Replace the cover by sliding the back edge into place first and lowering the front of the paper access cover.

---

# Cleaning, Disinfection and Sterilization

## Cleaning the MicroTym2 Handle

Do not sterilize the MicroTym2 Handle. Clean the Handle by wiping it with a dry cloth or a cloth that has been lightly dampened with 70% Isopropyl alcohol. **Make sure liquid does not seep into the instrument, especially in the probe area.** Inspect the probe opening and the three inside ports for debris monthly. Dust, cerumen, or other material in the probe may affect the accuracy and/or functioning of the instrument.

## Printer/Charger Cleaning

Do not sterilize the MicroTym2 Printer/Charger. Make sure liquid does not seep into either the printer area or the charging well. Clean the Printer/Charger by wiping it with a dry cloth or a cloth that has been lightly dampened with 70% Isopropyl alcohol.

## Disinfection and Sterilization of the Probe Tips

The probe tips should be disinfected after each patient.

According to the Occupational Safety and Health Administration (OSHA), the probe tips should be "cleaned and decontaminated...(if) contaminated with blood or other potentially infectious materials."

The probe tips may be sterilized as follows:

Ethylene Oxide: 130°F (54°C), 8 PSI (55 kPa), 4-hour cycle

Steam Autoclave: 270°F (132°C), 27 PSI (185 kPa), 6-minute cycle

The probe tips may be disinfected as follows:

Cidex™

Cidexplus™

70% Isopropyl alcohol

Betadine® (10% by volume)

Wescodyne® (10% by volume)

Metricide

Boiling water (30 minutes)

**NOTE: Zephiran® Chloride (with or without anti-rust tablets) is not recommended as a disinfection solution. Using Betadine, Wescodyne, or boiling water may discolor probe tips; however, performance is not affected.**

**If the probe tips are wiped while attached to the MicroTym2, point the probe tip down to prevent seepage of liquid into the probe tip.**

# Appendix D


## Functional Checks of the MicroTymp2 Handle and Printer/Charger

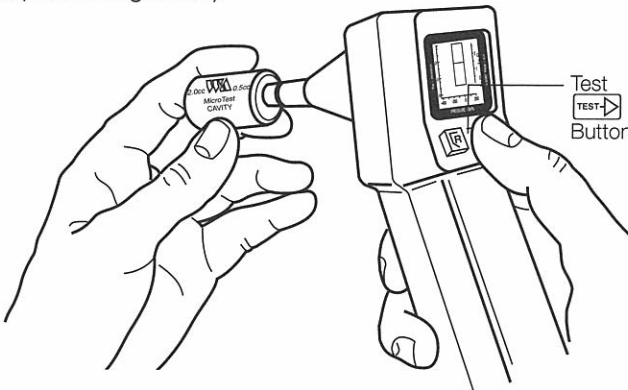
### Functional Checks of the MicroTymp2 Handle

A MicroTest Cavity is included with the MicroTymp2 Handle. The cavity provides a functional test of the MicroTymp2 Handle to determine if it is working properly. The 0.5 cc cavity is used to test the Low Range of ear canal volume (Vea). The 2.0 cc cavity is used to test the High Range of the ear canal volume (Vea).



Check the MicroTymp2 Handle with the MicroTest Cavity at least once a month and whenever the operation of the MicroTymp2 Handle is questioned.

To use the MicroTest Cavity, follow the steps below.

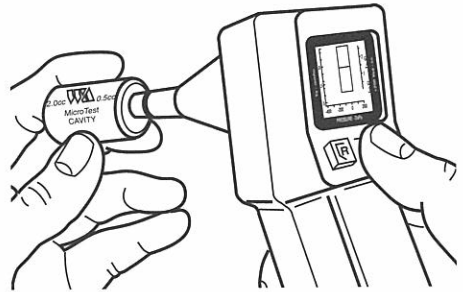
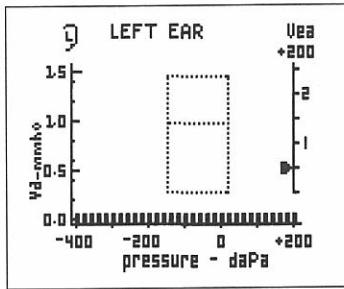
1. Using any size probe tip, place the MicroTymp2 probe tip against the 0.5 cc cavity as if it were an ear. See **Figure 43**. Hold the handle and MicroTest Cavity carefully to prevent movement. Depress the TEST  button and test the cavity as you would an ear (see page 6 for information on performing a test).



**Figure 43**

2. Store the information using either the right  or left  memory buttons.
3. Repeat Steps 1 and 2 using the 2.0 cc cavity. Store the information in the opposite memory location used in Step 2.
4. Print the information using the Printer/Charger.

5. A properly functioning instrument will produce a flat tympanogram and an ear canal volume (Vea) which corresponds to the cavity tested. There is an acceptable range for each cavity (see **Table 7**) both at sea level and at different altitudes. An example is provided in **Figure 44** below. Note that all data points must fall within the two bottom rows of the graph.



**Tympanogram from 0.5 cc cavity**

**Figure 44**

**Table 7 – Expected Vea Readings for MicroTest Cavity**

Cavity Measured	Acceptable Tolerance	Acceptable Range at Sea Level	Acceptable Range at 2600 Ft (792 m)	Acceptable Range at 5000 Ft (1525 m)
0.5 cc Cavity	±0.1 cc	0.4 cc to 0.6 cc	0.4 cc to 0.6 cc	0.5 cc to 0.7 cc
2.0 cc Cavity	±0.1 cc	1.9 cc to 2.1 cc	2.1 cc to 2.3 cc	2.3 cc to 2.5 cc

If the readings do not fall within the acceptable range, then the MicroTympanometer 2 Handle requires calibration. Send the MicroTympanometer 2 Handle to a Welch Allyn service location. See Appendix E, “Service and Warranty Information,” for a complete listing.

As the altitude above sea level increases, the admittance of an air-filled cavity also increases. Therefore, at altitudes above sea level, results using MicroTest Cavity change, as listed in **Table 7**.

**NOTE:** While the MicroTest Cavity provides a functional test, it does not replace full calibration. Welch Allyn recommends that the MicroTympanometer 2 Handle be recalibrated annually.



## Troubleshooting the MicroTymp 2 Handle

Symptom	Possible Cause	Possible Solution
<b>Handle Does Not Turn On</b>	No battery. Battery in backwards.  Battery not charged/dead.	Put battery in. Reposition battery observing polarity. Charge/replace battery.  If symptom still persists, return to local Welch Allyn service location for service.
<b>Too Much Artifact on LCD</b>	Too much movement during test.  Handle has too much internal noise.	See page A-31.  Check handle in cavity (page D-51). If handle passes cavity test, artifact is due to motion. If handle does not pass cavity test, return to Welch Allyn service location for service.
<b>“Frozen” Display on LCD</b>          <b>OR</b>          <b>“Checkerboard” Pattern on LCD</b>	Microcomputer has malfunctioned.	Push TEST and repeat.  If symptom persists, push all three handle buttons (TEST, R MEM, L MEM) simultaneously to reset microcomputer.  If symptom persists, remove and reinsert the battery.  If symptom persists, return to local Welch Allyn service location for service.

## Functional Checks of the Printer/Charger

Pressing the FEED  and PRINT  buttons simultaneously causes a test pattern to print. See **Figure 45** (on page D-54).

### 1 Test Pattern

The test pattern is used to confirm that the print head is functioning properly. If any of the print head elements are not functioning, a white line will appear vertically down the printout. A defect in the paper may also cause white lines or light printing. Repeat the test pattern to confirm any suspected printing problems. If paper advances but nothing prints out, check to be sure the paper is inserted properly (see page C-48).

② **Software Version**

The test pattern also includes the software version for the MicroTymp 2 Printer/Charger.

③ **Normative Data Reference**

The test pattern is followed by normative data for tympanometric characteristics for both the original MicroTymp and MicroTymp 2 Handle. This is provided along with the test pattern for the convenience of the user, not specifically as a functional check.

④ **Handle Data**

If the Handle is placed in the well as the test pattern is being printed, the printer reads the status of the Handle and prints out the results. DO NOT remove the handle while printing Handle data, or Handle data will be incomplete. The encoded data are only significant to the Technical Service Department at Welch Allyn.

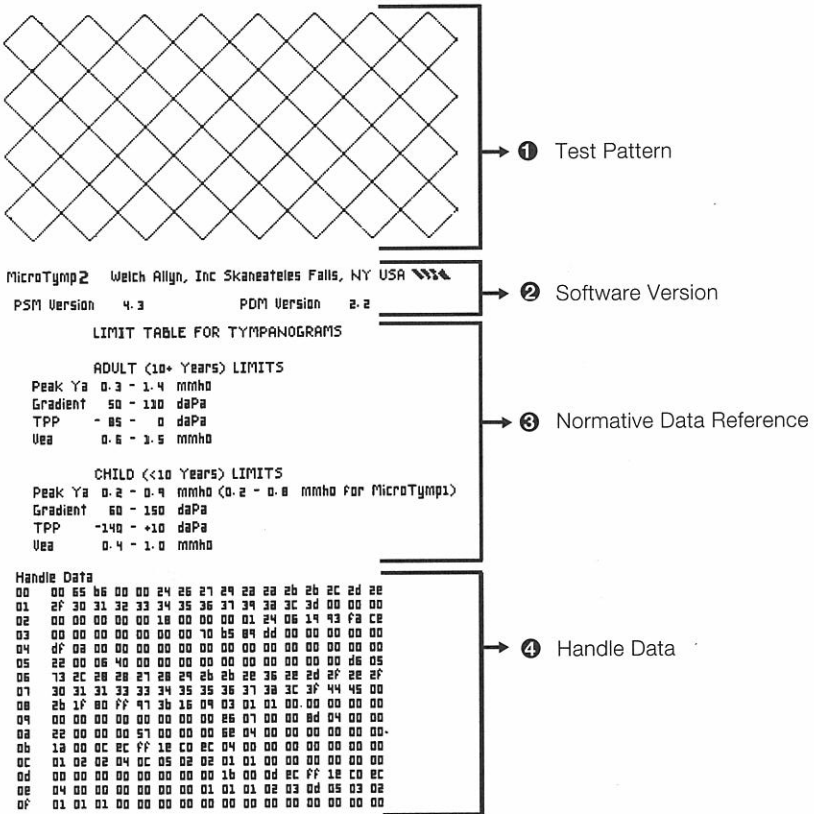


Figure 45

# Appendix E

## Service and Warranty Information

### Service

#### Repair

Repair must be performed by authorized personnel. Failure to do so invalidates the MicroTym2 warranty.

For customers in North America, please return instruments requiring service to a Welch Allyn Technical Service Department listed below or to an authorized Welch Allyn distributor.

#### **Technical Service Department**

Welch Allyn, Inc.  
4341 State Street Road  
Skaneateles Falls, NY 13153-0220  
U.S.A.  
Telephone: 800-669-9771 or  
315-685-4560  
Fax: 315-685-3361

#### **Technical Service Department**

Welch Allyn Canada Ltd.  
160 Matheson Blvd. East, Unit #2  
Mississauga, Ontario  
CANADA L4Z 1V4  
Telephone: 800-561-8797 (in Canada  
only) or 905-890-0004  
Fax: 905-890-0008

**For customers outside of North America, return your unit to a local, authorized Welch Allyn distributor.**

#### Recalibration

Welch Allyn recommends that the MicroTym2 Handle be recalibrated annually. Arrangements may be made by returning the MicroTym2 registration card or by contacting Welch Allyn's Technical Service Department or an authorized Welch Allyn MicroTym2 distributor. A moderate fee is charged for recalibration.

The MicroTym2 instrument warranty may be extended for up to three years provided the Handle is returned each year for recalibration.

A monthly functional check using the MicroTest Cavity is recommended.

The Printer/Charger does not require recalibration.

---

## Warranty

### MicroTymp 2 Instrument

Welch Allyn Inc. warrants the MicroTymp 2 Handle and Printer/Charger to be free of original defects in material and workmanship and to perform in accordance with manufacturer's specifications for a period of one year from the date of purchase. If this instrument or any component thereof is found to be defective or at variance from the manufacturer's specifications during the warranty period, Welch Allyn will repair, replace or recalibrate the instrument or component(s) at no cost to the purchaser.

This warranty only applies to instruments purchased new from Welch Allyn or its authorized distributors or representatives. The purchaser must return the instrument directly to Welch Allyn or an authorized MicroTymp2 distributor or representative and bear the costs of shipping.

This warranty does not cover breakage or failure due to tampering, misuse, neglect, accidents, modification or shipping, and is void if the instrument is not used in accordance with manufacturer's recommendations or if repaired or serviced by other than Welch Allyn or a Welch Allyn authorized representative.

#### **Extend the MicroTymp2 warranty from one to three years.**

This warranty can be extended to three years provided the MicroTymp2 Handle is returned to a Welch Allyn service location for recalibration annually. A moderate fee for recalibration will be charged.

Purchase date determines warranty and annual recalibration requirements. No other express or implied warranty is given.

**NOTE: Return of the instrument registration card is required for proof of purchase and warranty validation.**

### MicroTymp 2 Rechargeable Battery

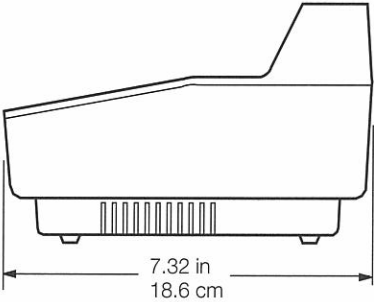
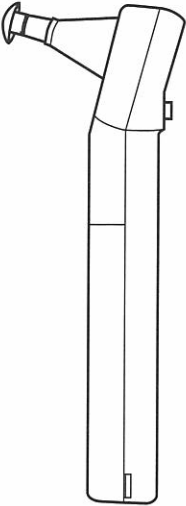
Welch Allyn nickel-cadmium batteries are warranted by Welch Allyn for two years from date of manufacture (when used in Welch Allyn instruments only). Defective batteries will be replaced on a pro rata basis should failure occur prior to expiration date on battery.

# Appendix F

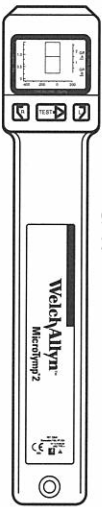
## Technical Specifications

Appendix F

3.68 in  
9.35 cm



1.94 in  
4.94 cm



9.70 in  
24.6 cm

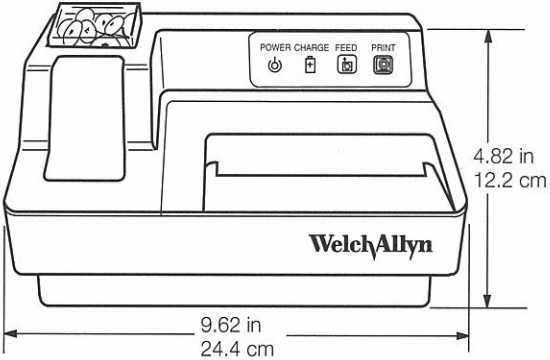


Figure 46

---

**Probe Tone:**

*Frequency:* 226 Hz  $\pm$ 3%

*Amplitude:* 85  $\pm$ 3 dB re 20  $\mu$ Pa in an ANSI HA-1 (2.0 cc) coupler

*Distortion:* 5% maximum total harmonic distortion in an ANSI HA-1 (2.0 cc) coupler

**Pump:**

*Direction of sweep:* positive to negative pressure

*Speed:* 400  $\pm$ 40 daPa/s average during data acquisition period

**Pressure Measurement System:**

*Range:* +200 to -400 daPa

*Display resolution:* 20 daPa

*Accuracy:*  $\pm$ 15% or  $\pm$ 10 daPa, whichever is greater

*Compensation:* Auto-zero every test cycle

**Admittance Measurement System:**

*Range:* 0.2 to 4.0 mmho total  
0.0 to 1.5 mmho for  $Y_a$   
0.2 to 2.5 cc for +200  $V_{ea}$

*Display resolution:* 0.1 mmho for  $Y_a$   
0.2 cc for +200  $V_{ea}$

*Accuracy:*  $\pm$ 0.1 mmho or  $\pm$ 5%, whichever is greater

**Weight:**

*MicroTymp2 Handle:* 0.61 lb/0.28 kg

*Printer/Charger:* 3.98 lb/1.81 kg

**Operating Temperature:**

15° to 35°C (59° to 95°F). All specifications apply within this temperature range.

**Storage Temperature:**

-20° to +40°C (-4° to +104°F)

**Battery (Welch Allyn #72900):**

2.4 V nickel-cadmium rechargeable, 14-16 hour recharge time

Full charge yields at least 300 double-ear tympanograms or approximately one full day of continuous use

**Probe Tips:**

Four color-coded sizes

**Printer Paper (Welch Allyn #56100):**

4.42" (112 mm) wide with core

Pink end-of-roll indicator





Approximate number of printouts per roll:

200 – Tympanogram, Data, and Messages reports

250 – Tympanogram and Data reports

300 – Tympanogram Only reports

**Table 8 – MicroTyp2 Printer/Chargers**

<b>Welch Allyn Model Number</b>	<b>Nominal Input</b>	<b>Major Geographic Areas</b>	<b>Plug Type</b>
<b>71170</b>	120 V~, 1A	<b>Canada, Japan, United States</b>	
<b>71172</b>	230 V~, 1A	<b>Europe</b>	
<b>71174</b>	230 V~, 1A	<b>United Kingdom</b>	
<b>71176</b>	230 V~, 1A	<b>Australia, New Zealand</b>	

**Operating Ranges:**

Input voltage for all Printer/Charger models is 100 to 240 V~

Input frequency for all Printer/Charger models is 50 to 60 Hz

Input current is 1A maximum

---

## Standards Compliance

ETL listed to comply with UL 2601

ETL listed to comply with CSA C22.2 No. 601-1

ETL listed to comply with IEC 601-1, Amendment 1



MicroTymp2 Handle:  
Class I Equipment, Type BF



MicroTymp2 Printer/Charger:  
Class I Equipment, Type B

FCC Part 15, Class A

This device complies with CFR 47 Part 15 Class A of the FCC rules. Operation is subject to the following two conditions:

- (1) This device may not cause harmful interference, and
- (2) This device must accept any interference received, including interference that may cause undesired operation.

CBC C108.8 M1983, Class A

This digital apparatus does not exceed the Class-A limits for radio noise emissions from digital apparatus set out in the Radio Interference Regulations of the Canadian Department of Communications.



The CE mark on this device indicates it has been tested to and conforms with the provisions noted within the 93/42/EEC Medical Device Directive.

Authorized European Representative Address:

European Regulatory Manager  
Welch Allyn, Ltd.,  
Kells Road, Navan,  
County Meath,  
Republic of Ireland  
Tel. 353 46 28122  
Fax 353 46 28536

This instrument complies with the following standards based on the most recent revision available at the time of design:

American National Standard for Instruments to Measure Aural Acoustic Impedance and Admittance — Aural Acoustic Immittance; ANSI S.39-1987 (ASA 71-1987)

ANSI Type 4 instrument

IEC — Instruments for the Measurement of Aural Acoustic Impedance/Admittance; IEC 1027:1991

IEC Type 4 instrument



# Appendix G

## MicroTymp 2 Replacement Parts and Accessories



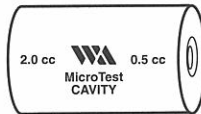
**Battery**  
#72900 2.4 V  
Nickel-Cadmium Battery



**Screw for Battery Cover**  
#236081



**Screw Driver for Battery Cover**  
#236200



**MicroTest Cavity**  
#711772-501



#23621  
(White)  
Small



#23622  
(Black)  
Medium



#23623  
(Gray)  
Large



#23624  
(Blue)  
Extra-Large

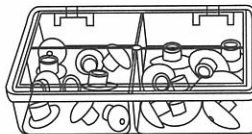
### Probe Tips

#23630 Set of 4 Tips

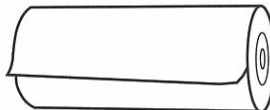


#711760-502 Tip Box Only

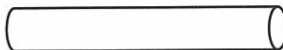
#711780-501 Tip Box with two sets of tips



#23639 Multi-pack of Tips  
(5 small,  
10 medium,  
10 large and  
5 extra-large)

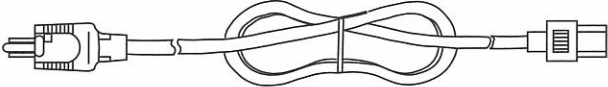


**MicroTymp 2 Paper**  
#56100 5 Rolls/Box,  
12 Boxes/Case



**Spindle for Paper**  
#761050-1

Replacement Power Cords



#761076-0  
120 V, Canada,  
Japan, U.S.



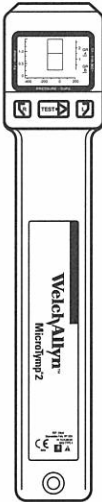
#761076-2  
230 V, Europe



#761076-4  
230 V, United  
Kingdom



#761076-6  
230 V, Australia,  
New Zealand



#23640  
Handle



Carrying Case  
for MicroTymz 2  
and AudioScope3  
(#05276)

# References

---

- American National Standards Institute (1987). "Specifications for Instruments to Measure Aural Acoustic Impedance and Admittance (Aural Acoustic Immittance)." New York: ANSI. ANSI S3.39-1987 (ASA71-1987).
- American Speech-Language-Hearing Association (1985). "Guidelines for Identification Audiometry." *ASHA*, 27, 49-52, May, 1985.
- American Speech-Language-Hearing Association (1990). "Guidelines for Screening for Hearing Impairments and Middle Ear Disorders." *ASHA* 32 (Suppl. 2): 17-24 (1990).
- Bak, David J. (1988). "Microelectronics and a Tiny Pump Make Ear Exams Easy." *Design News*, February 15, 1988.
- de Melker, Ruut (1992). "Diagnostic value of microtympanometry in primary care." *British Medical Journal*, Volume 304: 96-8 (1992).
- Goodhill, V. (1979). *Ear: Diseases, Deafness, and Dizziness*. Maryland: Harper and Row.
- Holte, L., Cavanaugh, R.M. Jr., Margolis, R.H. (1990). "Ear canal wall mobility and tympanometric shape in young infants." *The Journal of Pediatrics*, Volume 117, Number 1, Part 1: 77-80, July, 1990.
- Holte, L., Margolis, R.H., Cavanaugh, R.M. (1991). "Developmental Changes in Multifrequency Tympanograms." *Audiology*, 30:1, 1-24, 1991.
- International Electrotechnical Commission (1991). "Instruments for the Measurement of Aural Acoustic Impedance/Admittance." Dublin, Ireland: IEC 1027:1991.
- Lous, Jorgen (1989). "Eustachian Tube Dysfunction In Children, A comparison between MicroTymp and Middle Ear Analyzer 1722." Proceedings of a Conference on the Eustachian Tube and Middle Ear Diseases, Geneva, Switzerland, October 26-29, 1989.
- Margolis, R. H. (1981). "Fundamentals of Acoustic Immittance." In G. R. Popelka (ed.) *Hearing Assessment with the Acoustic Reflex*. New York: Grune and Stratton.
- Margolis, R. H., Heller, J. (1987). "Screening tympanometry: criteria for medical referral." *Audiology*, 26:197-208, 1987.
- Margolis, R. H., Shanks, J. E. (1991). "Tympanometry: Basic Principles and Clinical Applications." In Wm Rintelmann (ed.) *Hearing Assessment* (2nd ed.). Austin, TX: Pro-ed, Inc., 1991.
- Occupational Safety and Health Administration (1991). "Occupational Exposure to Bloodborne Pathogens; Final Rule." *Federal Register*, Vol. 56, No. 235, 29 CFR Part 1910.1030, 64175-64182, December, 1991.

---

Occupational Safety and Health Administration (1992). "Occupational Exposure to Bloodborne Pathogens." OSHA 3127, 1992.

Terkildsen, K., Thomsen, K. A., (1959). "The influence of pressure variations on the impedance of the human eardrum." *J. Laryngol. Otol.* 73:409-418.

U.S. Department of Health and Human Services (1994). "Managing Otitis Media with Effusion in Young Children." AHCPH Publication No. 94-0623, 1994.

U.S. Department of Health and Human Services (1994). "Otitis Media with Effusion in Young Children." AHCPH Publication No. 94-0622, 1994.

Van Camp, K. J., Margolis, R. H., Wilson, R. H., Creten, W., Shanks, J. E. (1986). "Principles of Tympanometry." *ASHA Monographs*. 24. Maryland: American Speech-Language-Hearing Association.

Wazen, Jack J.; Ferraro, Judith A.; Hughes, Robert (1988). "Clinical Evaluation of a Portable, Cordless, Hand-held Middle Ear Analyzer." *Otolaryngology — Head and Neck Surgery*, Volume 99, No. 3:348 - 350.

# Glossary

---

**acoustic admittance (Ya)** The ease with which acoustic energy is transferred into a system; the ratio of volume velocity to sound pressure.

**acoustic millimho (mmho)** The unit of acoustic admittance; 1 mmho =  $10^{-8}$  m<sup>3</sup>/Pa s.

**aural acoustic immittance** A term used to refer to aural acoustic admittance, acoustic impedance, or any of their components.

**cholesteatoma** See keratoma.

**compensated static acoustic admittance (Ya, Ytm)** The admittance of the middle ear at the air pressure corresponding to the tympanometric peak. It is calculated by subtracting the admittance of the ear canal from the admittance at the tympanometric peak. The MicroTymp2 estimates compensated admittance by subtracting the admittance at +200 daPa from the peak admittance.

**decapascal (daPa)** The unit of air pressure used for tympanometric measurements. 1 daPa = 1.04 mm H<sub>2</sub>O.

**equivalent ear canal volume (+200 Vea)** The volume of air that has the same acoustic admittance as the ear canal/middle ear system when the ear is pressurized. The MicroTymp2 Handle measures Vea with a 226-Hz probe tone and an ear canal air pressure of +200 daPa. Under these conditions, Vea is a good estimate of the volume of air in front of the probe. Vea is abnormally large in some patients with ear drum perforations and patent tympanostomy tubes.

**keratoma** A collection of keratinizing squamous epithelium that invades the middle ear; keratoma frequently originates from a perforation in Shrapnell's membrane (pars flaccida) of the tympanic membrane; also called cholesteatoma.

**lateral ossicular fixation** Fixation of the malleus and/or incus, frequently caused by tympanosclerosis, a complication of chronic otitis media.

**middle ear effusion** An accumulation of fluid (liquid) in the middle ear.

**neomembrane** A scar on the tympanic membrane; the scarred region may be thinner and have a higher admittance than the normal tympanic membrane; also called monomere.

**otalgia** Ear ache or pain.

**otitis media with effusion** Inflammation of the middle ear, often accompanied by an accumulation of fluid (liquid).

---

**otorrhea** External ear discharge.

**otosclerosis** A genetic abnormality of the temporal bone, frequently causing fixation of the stapes and conductive hearing loss.

**sound pressure** The average (rms) difference between the air pressure that occurs during sound transmission and the ambient air pressure.

**tympanogram** A recording of the admittance of the ear as a function of ear canal air pressure.

**tympanometric gradient** See tympanometric width.

**tympanometric peak pressure** The value of ear canal air pressure at which the tympanometric peak occurs.

**tympanometric width** A measure of the shape of the tympanogram in the region of the tympanometric peak. Defined as the width of the tympanogram (in decapascals) at 50% of peak eardrum admittance, tympanometric width is a good indicator of the presence of middle ear effusion.

**tympanometry** The measurement of acoustic admittance in the sealed ear canal as a function of ear canal air pressure.

**tympanosclerosis** A complication of otitis media that is characterized by sclerotic regions involving the tympanic membrane, ossicles, and middle ear mucosa. Tympanosclerosis increases the stiffness of the middle ear system.

**volume velocity** The volume of air that passes through a plane per unit time.



---

# WelchAllyn

Welch Allyn, Inc.  
4341 State Street Road  
P.O. Box 220  
Skaneateles Falls,  
New York 13153-0220  
U.S.A.

Tel.: 800-535-6663 (U.S.A. only)  
315-685-4560

Fax.: 315-685-3361

Printed in U.S.A.

Part No. 236311-2