



















Performance-LOAD® Cot Fastener System

Operations Manual

REF 6392



Symbols

	Refer to instruction manual/booklet
	Consult instructions for use
	General warning
	Caution
	Two person lift
	Catalogue number
	Serial number
	For US Patents see www.stryker.com/patents
	Authorized representative in the European Community
	European medical device
	Manufacturer
	Date of manufacture
	Importer
	CE mark
	Class II electrical equipment: equipment in which protection against electric shock does not rely on basic insulation only, but in which additional safety precautions such as double insulation or reinforced insulation are provided, there being no provision for protective earthing or reliance upon installation conditions.
	Direct current
	Medical Equipment Recognized by Underwriters Laboratories LLC With Respect to Electric Shock, Fire, and Mechanical Hazards only in accordance with ANSI/AAMI ES60601-1: 2005 and CAN/CSA-C22.2 No. 60601-1:08.
	Protection from objects greater than 12.5 mm and powerful water jets
	Medical Equipment Classified by Underwriters Laboratories Inc. With Respect to Electric Shock, Fire, and Mechanical Hazards Only in Accordance with ANSI/AAMI ES60601-1: 2005 and CAN/CSA-C22.2 No. 60601-1:08.





	<p>In accordance with European Directive 2012/19/EU on Waste Electrical and Electronic Equipment (WEEE) as amended, this symbol indicates that the product should be collected separately for recycling. Do not dispose of as unsorted municipal waste. Contact local distributor for disposal information. Ensure infected equipment is decontaminated prior to recycling.</p>
	<p>This way up</p>
	<p>Fragile, handle with care</p>
	<p>Keep dry</p>
	<p>Stacking limit by number</p>

Table of Contents

Warning/Caution/Note Definition	2
Summary of safety precautions	2
Introduction	4
Product description	4
Indications for use	4
Clinical benefits	4
Expected service life	4
Disposal/recycle	4
Contraindications	5
Specifications	5
Standards with required options	6
Product illustration	6
Contact information	7
Serial number location	7
Setup	8
Cot compatibility	8
Installation	9
Quality system regulation	9
21 CFR 820.170 installation	9
Installing the floor plate	10
Performance-LOAD assembly kit checklist	10
Selecting where to install Performance-LOAD	11
Installing Performance-LOAD	19
Installation checklist	24
Operation	25
Operating guidelines	25
Removing Performance-LOAD quickly	25
Checking the battery power level	26
Using a non-upgraded X-frame cot for a mass casualty incident	26
Unloading a compatible cot from Performance-LOAD	26
Loading a compatible cot into Performance-LOAD	27
Cleaning and disinfecting with wipes	29
Cleaning	30
Disinfecting	30
Preventive maintenance	31
EMC information	32

Warning/Caution/Note Definition

The words **WARNING**, **CAUTION**, and **NOTE** carry special meanings and should be carefully reviewed.

WARNING

Alerts the reader about a situation which, if not avoided, could result in death or serious injury. It may also describe potential serious adverse reactions and safety hazards.

CAUTION

Alerts the reader of a potentially hazardous situation which, if not avoided, may result in minor or moderate injury to the user or patient or damage to the product or other property. This includes special care necessary for the safe and effective use of the device and the care necessary to avoid damage to a device that may occur as a result of use or misuse.

Note - Provides special information to make maintenance easier or important instructions clearer.

Summary of safety precautions

Always read and strictly follow the warnings and cautions listed on this page. Service only by qualified personnel.

WARNING

- **Performance-LOAD** is designed to be compatible with the **Performance-PRO XT**, **Power-PRO XT**, and **Power-PRO IT** cots with a **Performance-LOAD** option. With the mass casualty option, you can use **Performance-LOAD** with a standard antler for most X-frame cots, but a rail clamp assembly and antler is required for all cots without a **Performance-LOAD** option.
- It is the responsibility of the cot operator to make sure that the cot being used in the Stryker Model 6392 **Performance-LOAD** system is a **Performance-LOAD** compatible cot. Injury may result if a non-compatible cot is used in the Stryker Model 6392 **Performance-LOAD** system.
- Always install the cot fastener system as described in this manual. Improper installation can result in injury. Make sure that, at a minimum, your configuration is tested to meet the National Truck Equipment Association/Ambulance Manufacturer's Division Standard 004, Litter Retention System Static Test (AMD-004).
- Take special precautions regarding electromagnetic compatibility (EMC) when you use medical electrical equipment. Install and place the cot fastener system into service according to the EMC information in this manual. Portable and mobile RF communications equipment can affect the function of the cot fastener system.
- Always seal all gaps to the exterior of the vehicle to prevent exhaust fumes from entering the vehicle patient compartment.
- Always make sure that you tighten all four floor plate bolts to the recommended torque.
- Always make sure of **Performance-LOAD** functionality before use. Failure may result in patient or operator injury.
- Always use caution when you move around in the vehicle patient compartment to avoid tripping on **Performance-LOAD**.
- Always use caution when you operate **Performance-LOAD** in adverse weather conditions (for example, rain, ice, snow).
- Always operate the cot or **Performance-LOAD** only when all persons are clear of the mechanisms. Entanglement in powered cot or **Performance-LOAD** mechanisms can cause serious injury.
- Always practice loading and unloading the cot with **Performance-LOAD** until operation of the product is fully understood. Improper use can cause injury.
- Do not allow untrained personnel to assist in the operation of **Performance-LOAD**. Untrained technicians/personnel can cause injury to the patient or themselves.
- Always use both hands when you handle the cot. **Performance-LOAD** is only an assisting device. Evaluate each situation to determine how to distribute and lift the weight that you are transporting.
- Always use enough operators to handle the forces that are required to load or unload when you handle weights over 400 lb (181 kg). To increase safety, operators should load or unload on flat surfaces. For 36 in. (91 cm) vehicle deck heights, you may need to manually unload.
- Always avoid extreme parking angles.
- Do not remove the battery when the cot is active.

- Always load or unload an occupied cot into a vehicle with a minimum of two trained operators.
 - Always be ready to support the entire weight of the cot and patient when you unload a cot from the vehicle patient compartment.
 - Always check for sheets, restraints, or debris that may catch in the cot transport wheels or load wheels.
 - Do not extend the cot base while it is locked into **Performance-LOAD**.
 - Always allow occupants to enter the vehicle patient compartment after the compatible cot has been loaded into the vehicle patient compartment.
 - Always use any appropriate personal protective equipment while power washing to avoid inhaling contagion. Power washing equipment may aerate contamination.
-

CAUTION

- Improper usage of the product can cause injury to the patient or operator. Operate the product only as described in this manual.
 - Do not modify the product or any components of the product. Modifying the product can cause unpredictable operation resulting in injury to patient or operator. Modifying the product also voids its warranty.
 - The use of accessories and cables, other than those specified, with the exception of cables that are sold by Stryker as replacement parts for internal components, may result in increased emissions or decreased immunity of the **Performance-LOAD** system.
 - Do not use the **Performance-LOAD** system and the **Power-PRO** cot adjacent to or stacked with other equipment. If adjacent or stacked use is necessary, observe the **Performance-LOAD** system to confirm normal operation in the configuration where it will be used.
 - Do not use portable RF communications equipment (including peripherals such as antenna cables and external antennas) no closer than 30 cm (12 in.) to any part of the **Performance-LOAD** system, including cables specified by the manufacturer. Otherwise, degradation of the performance of this equipment could result.
 - The emissions characteristics of this equipment make it suitable for use in industrial areas and hospitals (CISPR 11 class A). This equipment generates, uses, and can radiate radio frequency energy and, if not installed and used in accordance with the instruction manual, may cause harmful interference to radio communications. Operation of this equipment in a residential area (for which CISPR 11 class B is normally required) is likely to cause harmful interference in which case the user will be required to correct the interference at their expense. In the event of interference, please relocate or reorient the **Performance-LOAD** system or interfering product.
 - Always place the wire inside the floor plate pocket, so the fastener assembly does not pinch the wire when you install the fastener assembly.
 - Always charge the battery before you place the product into service. An uncharged or depleted battery may cause poor product performance.
 - Do not push the cot into the vehicle patient compartment until you fully retract the cot base.
 - Do not clean, disinfect, service, or perform maintenance while the product is in use.
-

Introduction

This manual assists you with the operation or maintenance of your Stryker product. Read this manual before operating or maintaining this product. Set methods and procedures to educate and train your staff on the safe operation or maintenance of this product.

CAUTION

- Improper usage of the product can cause injury to the patient or operator. Operate the product only as described in this manual.
 - Do not modify the product or any components of the product. Modifying the product can cause unpredictable operation resulting in injury to patient or operator. Modifying the product also voids its warranty.
-

Note

- This manual is a permanent part of the product and should remain with the product even if the product is sold.
- Stryker continually seeks advancements in product design and quality. This manual contains the most current product information available at the time of printing. There may be minor discrepancies between your product and this manual. If you have any questions, contact Stryker Customer Service or Technical Support at 1-800-327-0770.

Product description

Performance-LOAD is a manual cot fastener designed to secure compatible ambulance cots into a ground-based transport vehicle for patient transportation purposes and to allow for the insertion and removal of the compatible ambulance cots.

When the compatible cot is secured in the transport position, **Performance-LOAD** can inductively charge compatible model ambulance cots with an inductive charging option. In the event of loss of charging, **Performance-LOAD** remains functional for guiding into, securing within, and removing the cot from the vehicle.

Indications for use

Performance-LOAD is intended to guide the loading and unloading of a compatible ambulance cot (wheeled stretcher) to and from a ground-based transport vehicle and to secure the ambulance cot during transport in a fastened position while also providing an optional inductive charging platform for charge-compatible ambulance cots.

Clinical benefits

Cot: patient transport

Fastener: support cot for transport

Cot and fastener system: support and transport patients

Expected service life

The **Performance-LOAD** cot fastener has a seven year expected service life under normal use conditions and with appropriate periodic maintenance.

Disposal/recycle

Always follow the current local recommendations and/or regulations governing environmental protection and the risks associated with recycling or disposing of the equipment at the end of its useful life.

Contraindications

None known.

Specifications

Length	70 in.	178 cm
Width	19 in.	48 cm
Height	6 in.	15 cm
Floor plate assembly weight	16.5 lb	7.5 kg
Fastener assembly weight	46 lb	21 kg
Minimum operators required for loading/unloading an occupied cot	2	
Minimum operators required for loading/unloading an unoccupied cot	1	
Recommended loading height	22 in. to 36 in.	56 cm to 91 cm
Electrical requirements - inductive charging (optional)	12.8 VDC-15.6 VDC, 15A fuse/breaker, 2 conductor 10 AWG cable	
Standards	KKK-A-1822F With inductive charging: IEC 60601-1 Edition 3.0, IEC 60601-1 Edition 3.1, IEC 60601-1-2 Edition 3.0, IEC 60601-1-2 Edition 4.0, IEC 60601-1-12 Edition 1.0, ANSI/AAMI ES60601-1: 2005/(R)2012, CSA-C22.2 No. 60601-1 (2014) For standards that require specific options, see <i>Standards with required options</i> (page 6).	

Stryker reserves the right to change specifications without notice. Patents pending.

The yellow and black color scheme is a proprietary trademark of Stryker Corporation.

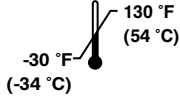
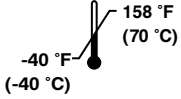
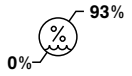
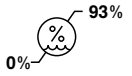
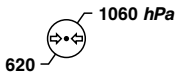
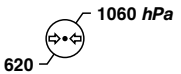
Environmental conditions	Operation	Storage and transportation
Temperature		
Relative humidity		
Atmospheric pressure		

CAUTION

- The use of accessories and cables, other than those specified, with the exception of cables that are sold by Stryker as replacement parts for internal components, may result in increased emissions or decreased immunity of the **Performance-LOAD** system.
- Do not use the **Performance-LOAD** system and the **Power-PRO** cot adjacent to or stacked with other equipment. If adjacent or stacked use is necessary, observe the **Performance-LOAD** system to confirm normal operation in the configuration where it will be used.

- Do not use portable RF communications equipment (including peripherals such as antenna cables and external antennas) no closer than 30 cm (12 in.) to any part of the **Performance-LOAD** system, including cables specified by the manufacturer. Otherwise, degradation of the performance of this equipment could result.
- The emissions characteristics of this equipment make it suitable for use in industrial areas and hospitals (CISPR 11 class A). This equipment generates, uses, and can radiate radio frequency energy and, if not installed and used in accordance with the instruction manual, may cause harmful interference to radio communications. Operation of this equipment in a residential area (for which CISPR 11 class B is normally required) is likely to cause harmful interference in which case the user will be required to correct the interference at their expense. In the event of interference, please relocate or reorient the **Performance-LOAD** system or interfering product.

Standards with required options

To be compliant with the standards, you must use **Performance-LOAD** with the following compatible cots. See the Operations Manual for your cot model for more information.

Note - Compatible cot is loaded into **Performance-LOAD** in powered mode for crash testing.

Standard	Performance-LOAD compatible cot models
SAE J3027	6506, 6086
BS EN 1789:2007 +A2:2014 and AS/NZS-4535:1999 applicable clauses	6506

Product illustration

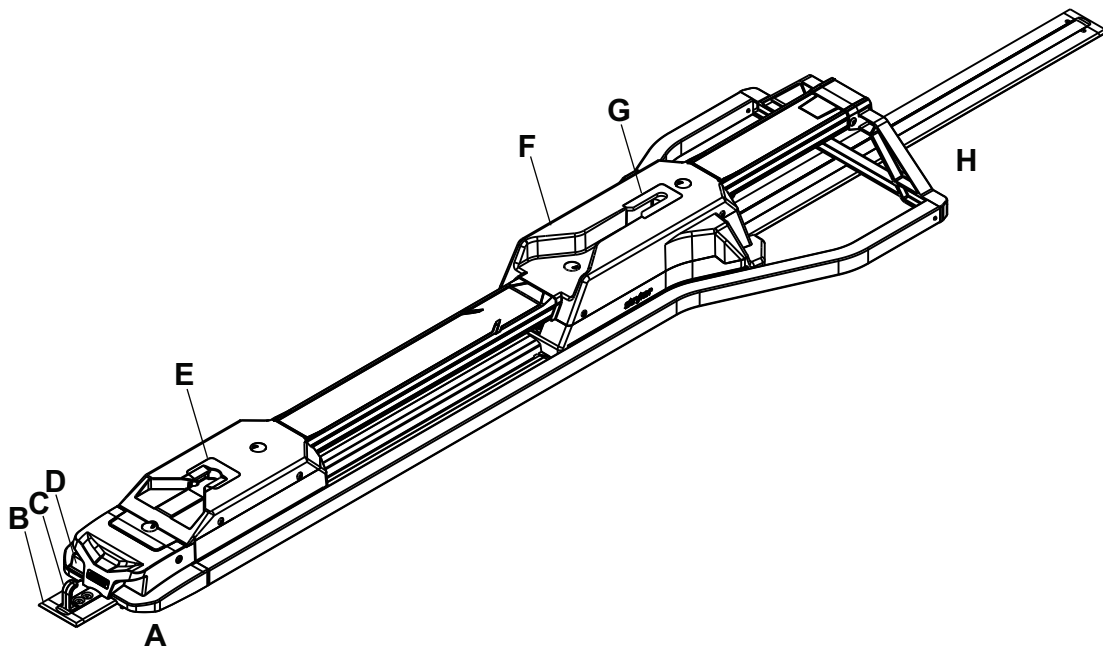

A	Foot end
B	Floor plate
C	Safety hook
D	Release button

E	Foot end interface
F	Cot fastener
G	Head end interface
H	Head end

Contact information

Contact Stryker Customer Service or Technical Support at: 1-800-327-0770.

Stryker Medical
3800 E. Centre Avenue
Portage, MI 49002
USA

Note - The user and/or the patient should report any serious product-related incident to both the manufacturer and the Competent authority of the European Member State where the user and/or patient is established.

To view your operations or maintenance manual online, see <https://techweb.stryker.com/>.

Have the serial number (A) of your Stryker product available when calling Stryker Customer Service or Technical Support. Include the serial number in all written communication.

Serial number location

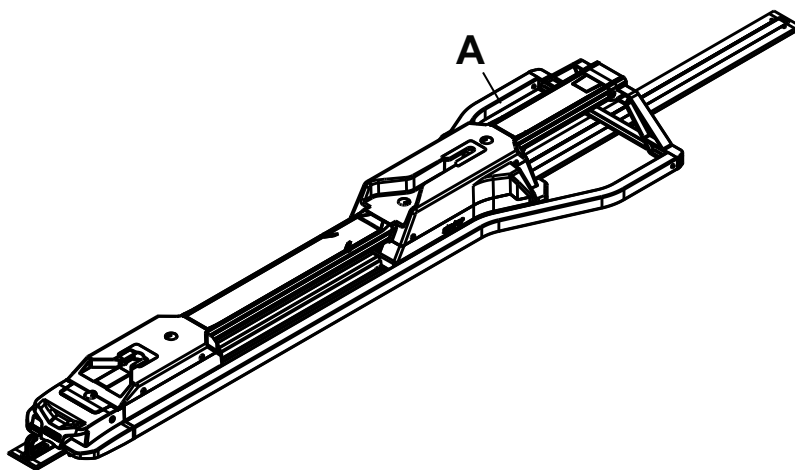

Figure 1 – Serial number location

Setup

During setup, unpack the cartons and check all items for proper operation. Make sure that the product works properly before you place it in service.

Remove all the shipping and packaging materials from the product before use.

The condition of **Performance-LOAD** is the responsibility of the user. Have a qualified service person use the following list and the operation guide instructions to check **Performance-LOAD** functionality.

1. Confirm that the installation checklist is complete (*Installation checklist* (page 24)).
2. If the installation checklist was completed by a third-party installer, the end user should repeat the installation checklist. Do not place **Performance-LOAD** into service if you cannot complete the installation checklist.

Cot compatibility

The Stryker Model 6392 **Performance-LOAD** system is compatible with cots with a **Performance-LOAD** compatible option.

WARNING

- **Performance-LOAD** is designed to be compatible with the **Performance-PRO XT**, **Power-PRO XT**, and **Power-PRO IT** cots with a **Performance-LOAD** option. With the mass casualty option, you can use **Performance-LOAD** with a standard antler for most X-frame cots, but a rail clamp assembly and antler is required for all cots without a **Performance-LOAD** option.
 - It is the responsibility of the cot operator to make sure that the cot being used in the Stryker Model 6392 **Performance-LOAD** system is a **Performance-LOAD** compatible cot. Injury may result if a non-compatible cot is used in the Stryker Model 6392 **Performance-LOAD** system.
-

Cots that currently meet these specifications are:

- Model 6086 **Performance-PRO XT** with a **Performance-LOAD** option (factory installed) or compatibility kit (6086-700-007)
- Model 6506 **Power-PRO XT** with a **Performance-LOAD** option (factory installed) or compatibility kit (6506-700-002 or 6506-700-014)
- Model 6516 **Power-PRO IT** with a **Performance-LOAD** option (factory installed) or compatibility kit (6516-700-002)
- Model 6500 **Power-PRO XT** with a **Performance-LOAD** compatibility kit (6500-700-065 or 6500-700-066)

Installation

Quality system regulation

WARNING

- Always install the cot fastener system as described in this manual. Improper installation can result in injury. Make sure that, at a minimum, your configuration is tested to meet the National Truck Equipment Association/Ambulance Manufacturer's Division Standard 004, Litter Retention System Static Test (AMD-004).
 - Take special precautions regarding electromagnetic compatibility (EMC) when you use medical electrical equipment. Install and place the cot fastener system into service according to the EMC information in this manual. Portable and mobile RF communications equipment can affect the function of the cot fastener system.
-

The U.S. Food and Drug Administration (FDA) Code of Federal Regulations (CFR) Title 21 provides guidance regarding the installation of devices, such as the cot fastener system. To comply with these federal regulations, each device must be verified to have been properly installed by trained* individuals by following the inspection criteria in the installation checklist. This document must be maintained for a minimum of seven years for each serial number/installation.

*The installation facility must maintain their own training records showing that the installer was qualified.

21 CFR 820.170 installation

(a) Each manufacturer of a device requiring installation shall establish and maintain adequate installation and inspection instructions, and where appropriate test procedures. Instructions and procedures shall include directions for ensuring proper installation so that the device will perform as intended after installation. The manufacturer shall distribute the instructions and procedures with the device or otherwise make them available to the persons installing the device.

(b) The person installing the device shall make sure that the installation, inspection, and any required testing are performed in accordance with the manufacturer's instructions and procedures and shall document the inspection and any test results to demonstrate proper installation.

Installing the floor plate

Install the Stryker universal floor plate in your vehicle patient compartment before you install your cot fastener system. See the Stryker Floor Plate Installation Manual (6390-109-020) for instructions.

Performance-LOAD assembly kit checklist

Make sure that you have all the required components to install the **Performance-LOAD** system.

Performance-LOAD assembly kit components (6392-001-014)

- (2) Cleat (6392-001-400)
- (4) Flat head cap screw (0001-194-000)
- (4) Cleat locator washer (6392-001-401)
- (1) Center cover assembly (6392-001-011)
 - (1) Hex wrench (0057-011-000)
 - (1) Floor plate cover (6392-001-403)
 - (1) Removal tool extension (6392-001-406)

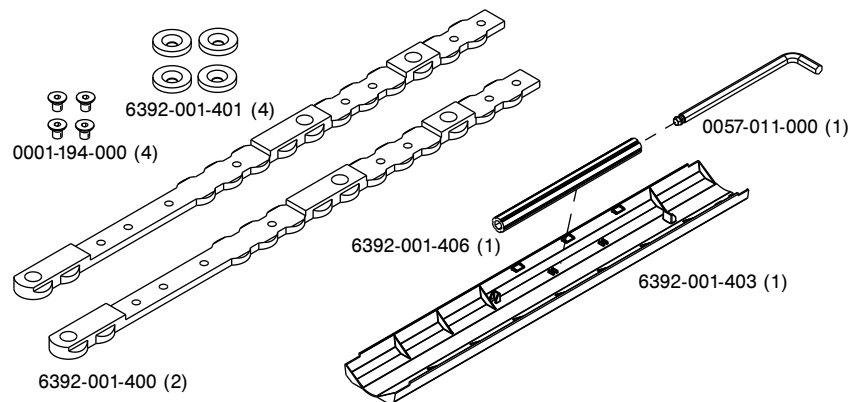

Figure 2 – Performance-LOAD assembly kit components

Note - Store the hex wrench and removal tool extension (Figure 3) inside of the center cover assembly, so you can access these tools when you are *Removing Performance-LOAD quickly* (page 25).

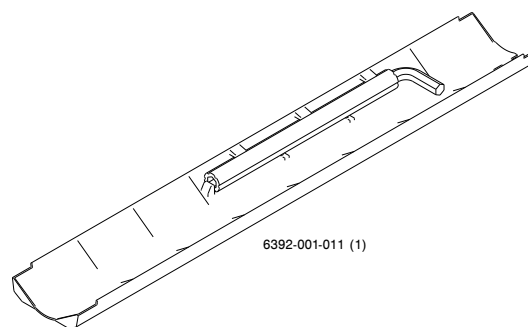

Figure 3 – Hex wrench and removal tool extension

Selecting where to install Performance-LOAD

Follow these steps to determine location and orientation of cleats and washer locations:

1. Select your sill to cot distance (A) (Figure 4).
Record your distance here: _____
2. Using the table below, select your Section based on your sill to cot distance (A).
Record your section here: _____
3. Proceed to your section to install your cleats.

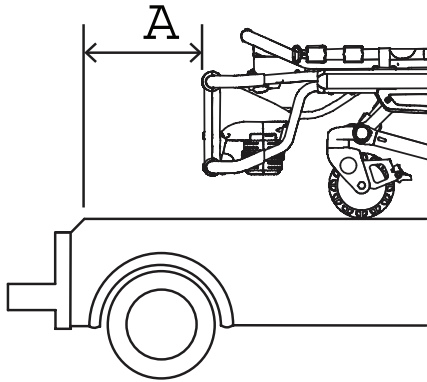

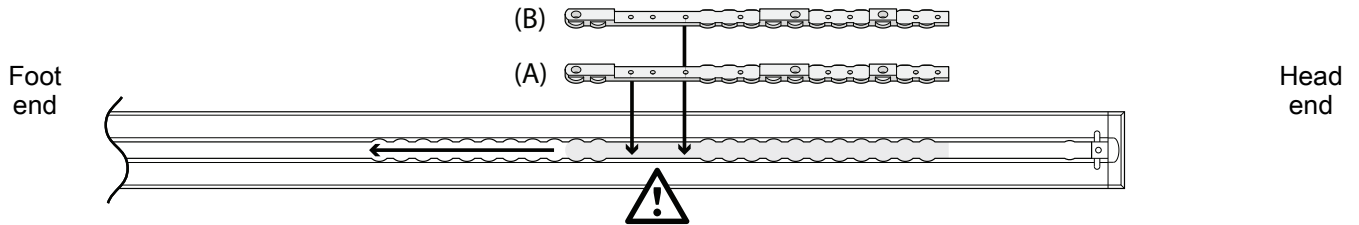

Figure 4 – Sill to cot distance (A)

Sill to cot distance (A)	Section
5 in. (13 cm)	Section A (page 12)
6 in. (15 cm)	Section B (page 12)
7 in. (18 cm)	Section C (page 12)
8 in. (20 cm)	Section D (page 13)
9 in. (23 cm)	Section E (page 13)
10 in. (25 cm)	Section F (page 15)
11 in. (28 cm)	Section G (page 15)
12 in. (30 cm)	Section H (page 15)
13 in. (33 cm)	Section I (page 16)
14 in. (36 cm)	Section J (page 16)
15 in. (38 cm)	Section K (page 16)
16 in. (41 cm)	Section L (page 17)
17 in. (43 cm)	Section M (page 17)
18 in. (46 cm)	Section N (page 17)
19 in. (48 cm)	Section O (page 18)
20 in. (51 cm)	Section P (page 18)
21 in. (53 cm)	Section Q (page 18)

You can only insert cleats where indicated by . Use the necked area of the cleats to line up with the floor plate, so they drop in. Both cleats are identical and must be installed flat-side down. Both cleat dimensions are taken from the cap at the end of the floor plate.

1. Insert your first cleat (A) and slide toward the foot end.
2. Insert your second cleat (B).



3. Determine your cleat (6392-001-400) and cleat locator washer (6392-001-401) locations per your Section below.
4. Using a 5/32" hex wrench, install four flat head cap screws (0001-194-000) and four cleat locator washers to secure the cleats. Make sure that you install two cleat locator washers per cleat.
5. Proceed to *Installing Performance-LOAD* (page 19).

Section A: 5 in. (13 cm) sill to cot distance

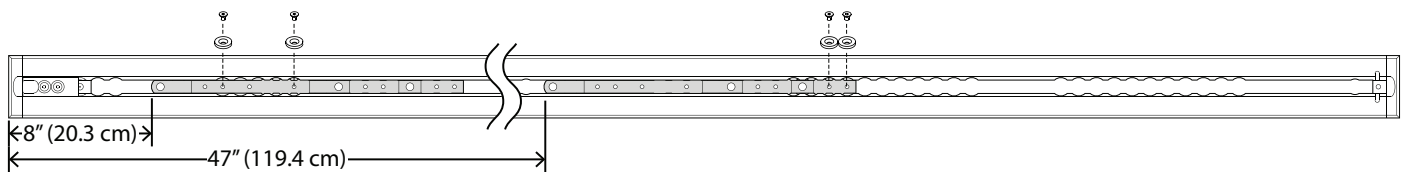

Section B: 6 in. (15 cm) sill to cot distance

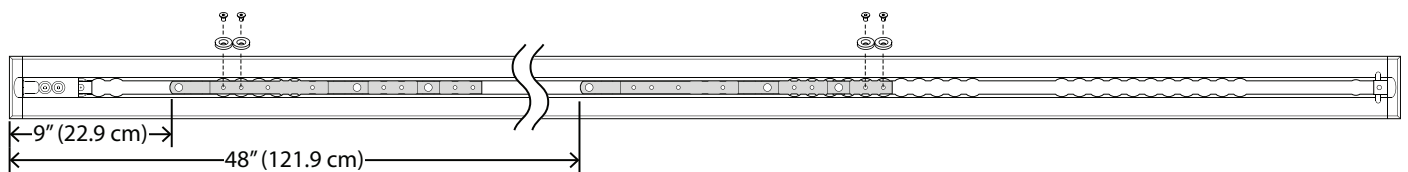

Section C: 7 in. (18 cm) sill to cot distance

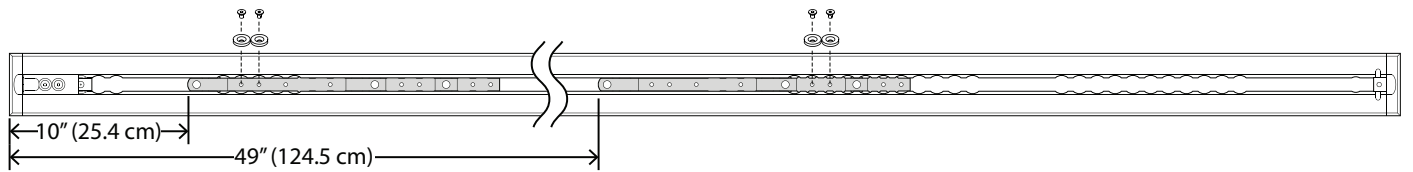

You can only insert cleats where indicated by . Use the necked area of the cleats to line up with the floor plate, so they drop in. Both cleats are identical and must be installed flat-side down. Both cleat dimensions are taken from the cap at the end of the floor plate.

1. Insert your first cleat (A) and slide toward the foot end.
2. Insert your second cleat (B).

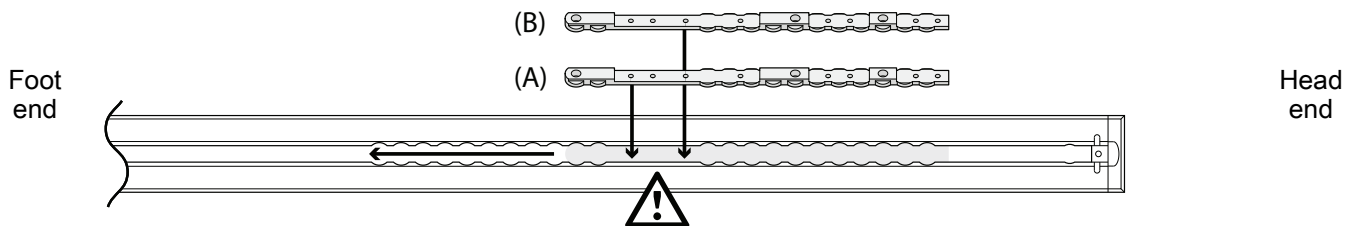

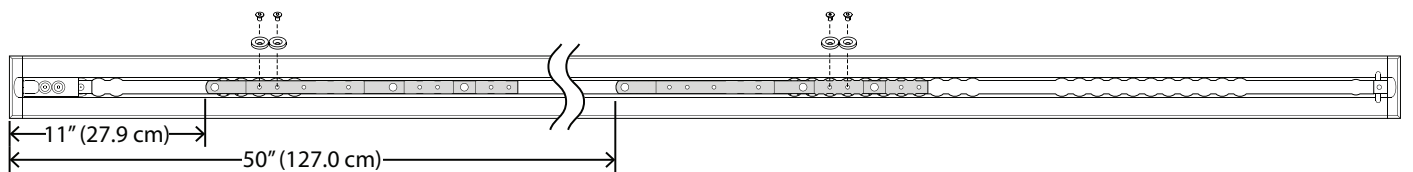

3. Determine your cleat (6392-001-400) and cleat locator washer (6392-001-401) locations per your Section below.
4. Using a 5/32" hex wrench, install four flat head cap screws (0001-194-000) and four cleat locator washers to secure the cleats. Make sure that you install two cleat locator washers per cleat.
5. Proceed to *Installing Performance-LOAD* (page 19).

Section D: 8 in. (20 cm) sill to cot distance

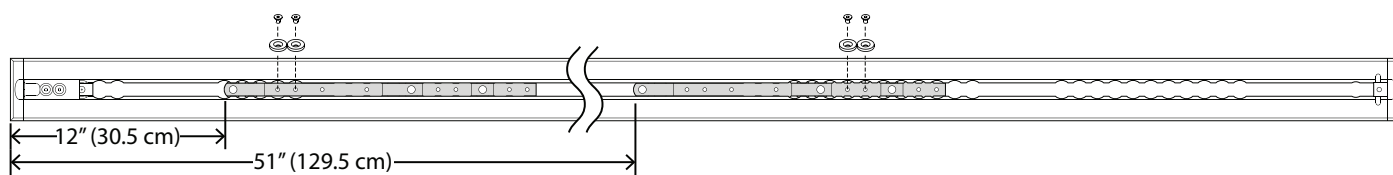

Section E: 9 in. (23 cm) sill to cot distance



You can only insert cleats where indicated by . Use the necked area of the cleats to line up with the floor plate, so they drop in. Both cleats are identical and must be installed flat-side down. Both cleat dimensions are taken from the cap at the end of the floor plate.

1. Insert your first cleat (A) and slide toward the foot end.
2. Insert your second cleat (B).

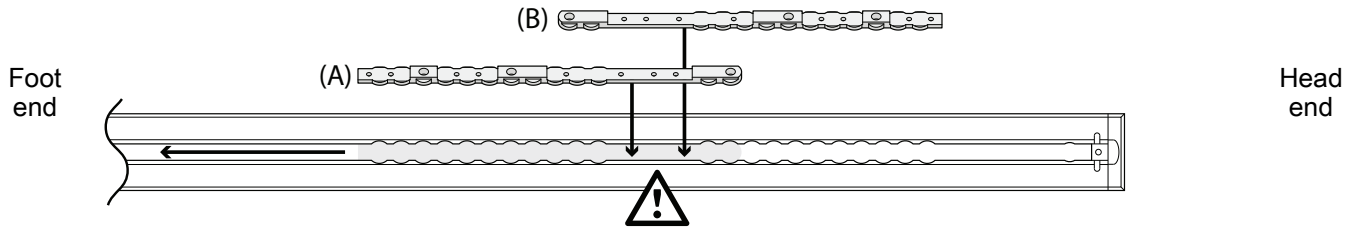

3. Determine your cleat (6392-001-400) and cleat locator washer (6392-001-401) locations per your Section below.
4. Using a 5/32" hex wrench, install four flat head cap screws (0001-194-000) and four cleat locator washers to secure the cleats. Make sure that you install two cleat locator washers per cleat.
5. Proceed to *Installing Performance-LOAD* (page 19).

Section F: 10 in. (25 cm) sill to cot distance

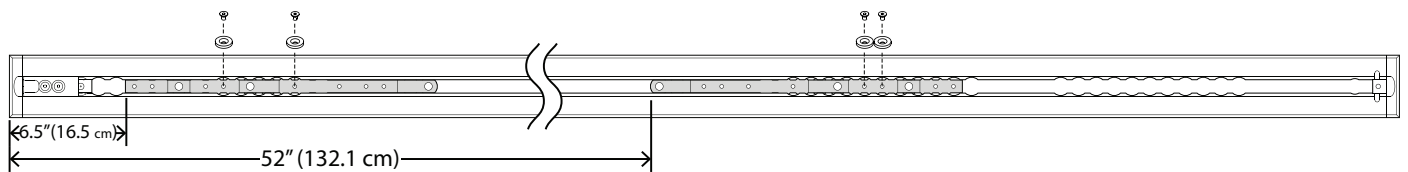

Section G: 11 in. (28 cm) sill to cot distance

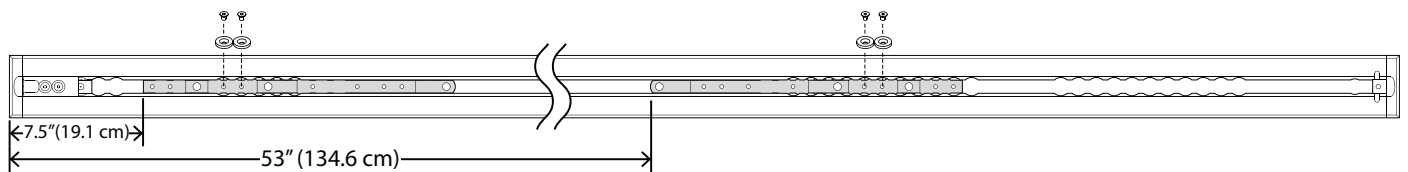

Section H: 12 in. (30 cm) sill to cot distance

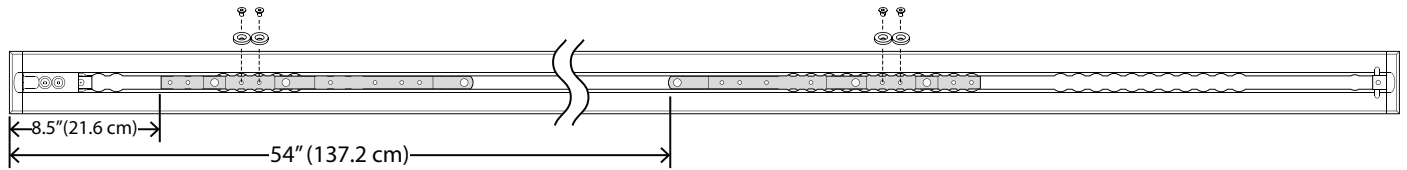

You can only insert cleats where indicated by . Use the necked area of the cleats to line up with the floor plate, so they drop in. Both cleats are identical and must be installed flat-side down. Both cleat dimensions are taken from the cap at the end of the floor plate.

1. Insert your first cleat (A) and slide toward the foot end.
2. Insert your second cleat (B).

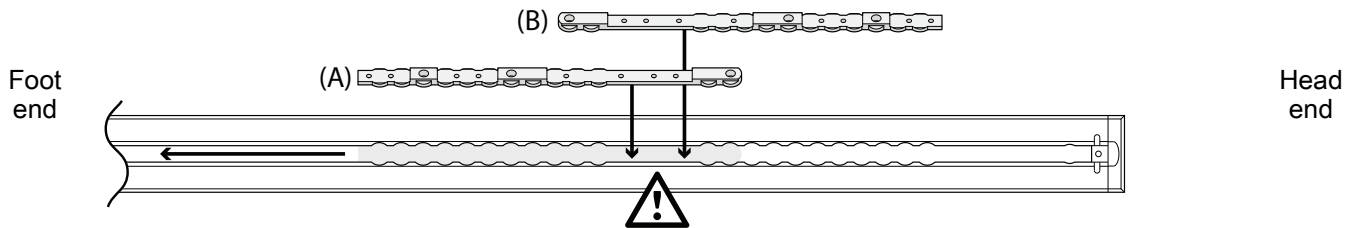

3. Determine your cleat (6392-001-400) and cleat locator washer (6392-001-401) locations per your Section below.
4. Using a 5/32" hex wrench, install four flat head cap screws (0001-194-000) and four cleat locator washers to secure the cleats. Make sure that you install two cleat locator washers per cleat.
5. Proceed to *Installing Performance-LOAD* (page 19).

Section I: 13 in. (33 cm) sill to cot distance

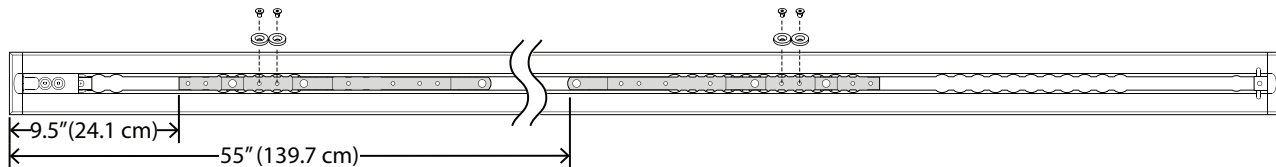

Section J: 14 in. (36 cm) sill to cot distance

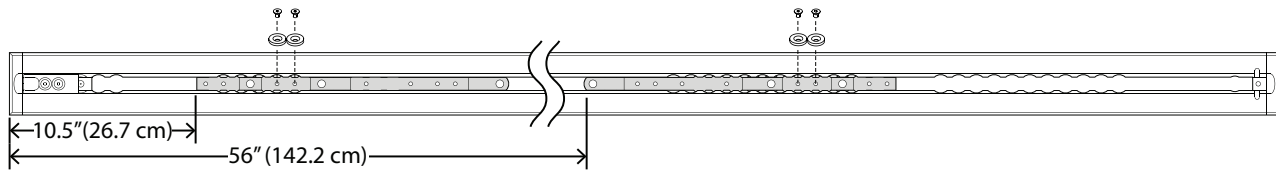

Section K: 15 in. (38 cm) sill to cot distance

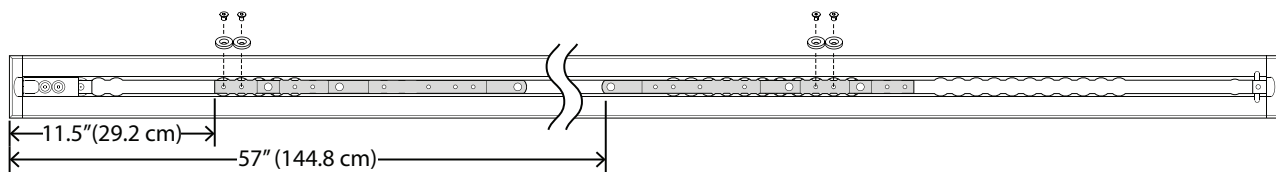

You can only insert cleats where indicated by . Use the necked area of the cleats to line up with the floor plate, so they drop in. Both cleats are identical and must be installed flat-side down. Both cleat dimensions are taken from the cap at the end of the floor plate.

1. Insert your first cleat (A) and slide toward the foot end.
2. Insert your second cleat (B).

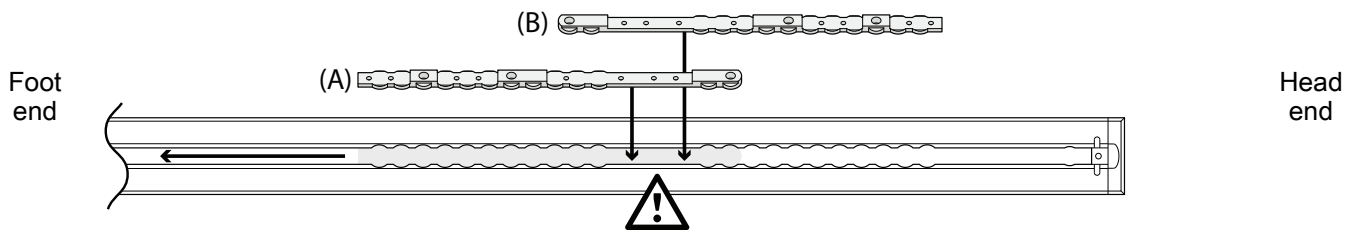

3. Determine your cleat (6392-001-400) and cleat locator washer (6392-001-401) locations per your Section below.
4. Using a 5/32" hex wrench, install four flat head cap screws (0001-194-000) and four cleat locator washers to secure the cleats. Make sure that you install two cleat locator washers per cleat.
5. Proceed to *Installing Performance-LOAD* (page 19).

Section L: 16 in. (41 cm) sill to cot distance

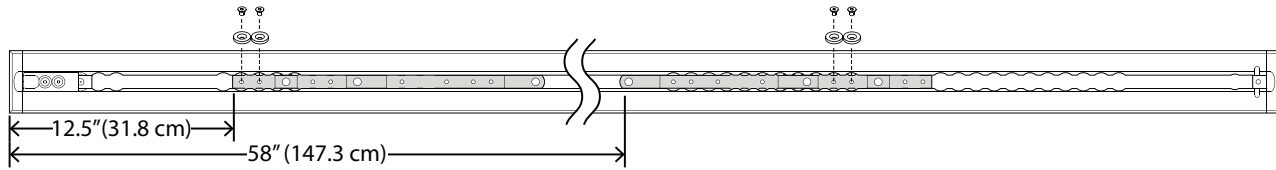

Section M: 17 in. (43 cm) sill to cot distance

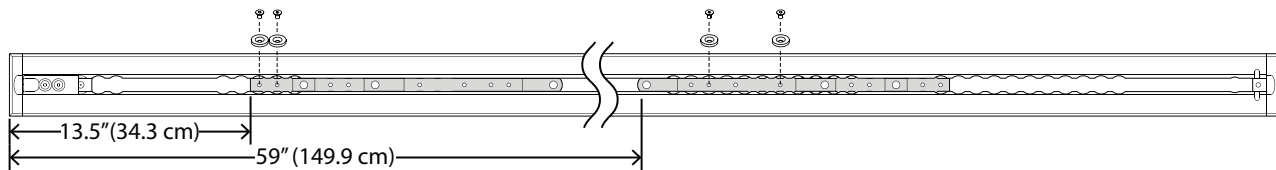

Section N: 18 in. (46 cm) sill to cot distance

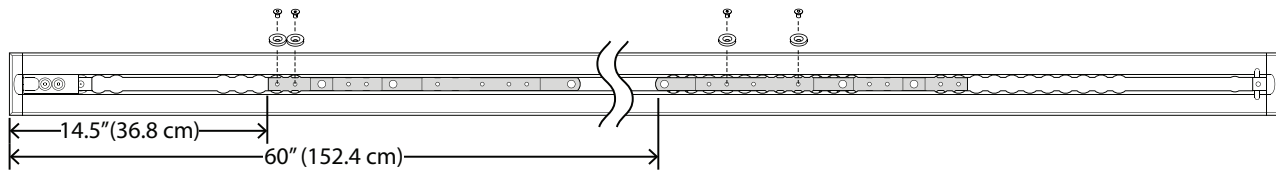

You can only insert cleats where indicated by . Use the necked area of the cleats to line up with the floor plate, so they drop in. Both cleats are identical and must be installed flat-side down. Both cleat dimensions are taken from the cap at the end of the floor plate.

1. Insert your first cleat (A) and slide toward the foot end.
2. Insert your second cleat (B).

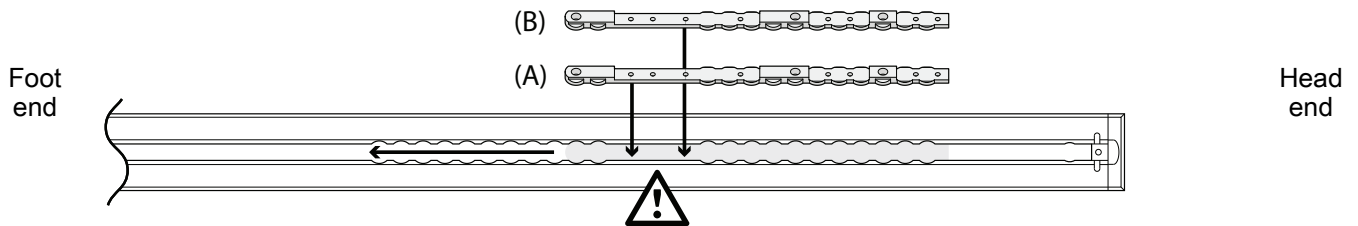

3. Determine your cleat (6392-001-400) and cleat locator washer (6392-001-401) locations per your Section below.

4. Using a 5/32" hex wrench, install four flat head cap screws (0001-194-000) and four cleat locator washers to secure the cleats. Make sure that you install two cleat locator washers per cleat.
5. Proceed to *Installing Performance-LOAD* (page 19).

Section O: 19 in. (48 cm) sill to cot distance

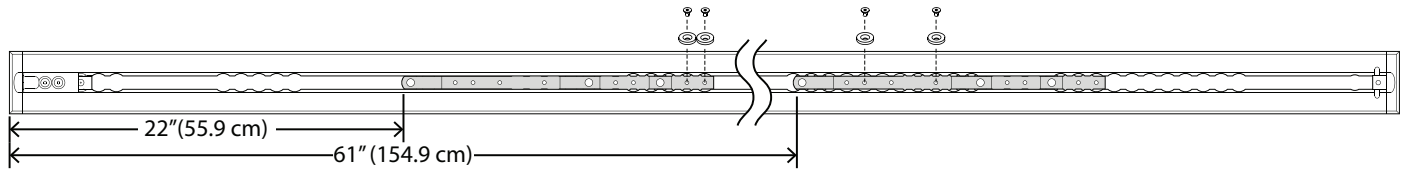

Section P: 20 in. (51 cm) sill to cot distance

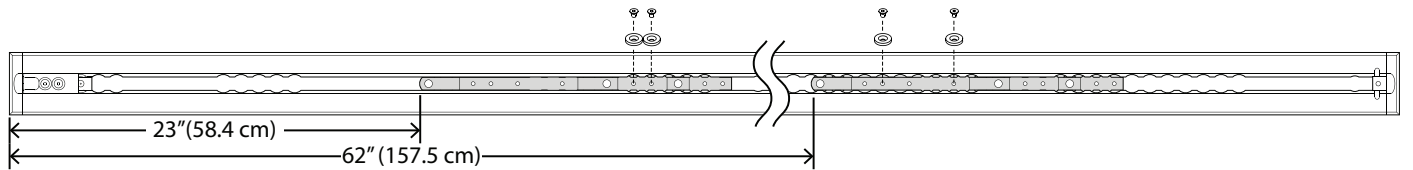

Section Q: 21 in. (53 cm) sill to cot distance

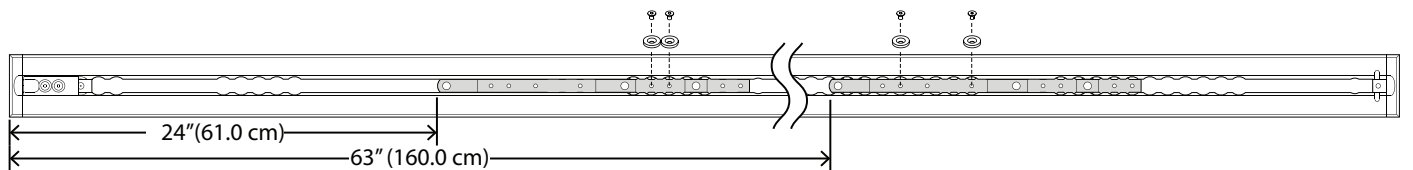

Installing Performance-LOAD

Tools required:

Hack saw

Slotted screwdriver

3/8" drive torque wrench (ft-lb) > 60 ft-lb

T27 Torx driver

Rubber hammer

3/8" hex wrench (at least 5-3/8 in. (13.7 cm) length)

Silicone sealant

Procedure:

1. Carefully place **Performance-LOAD** on top of the floor plate assembly. Align the two bolts at the head end with the two holes in the cleat (Figure 5).

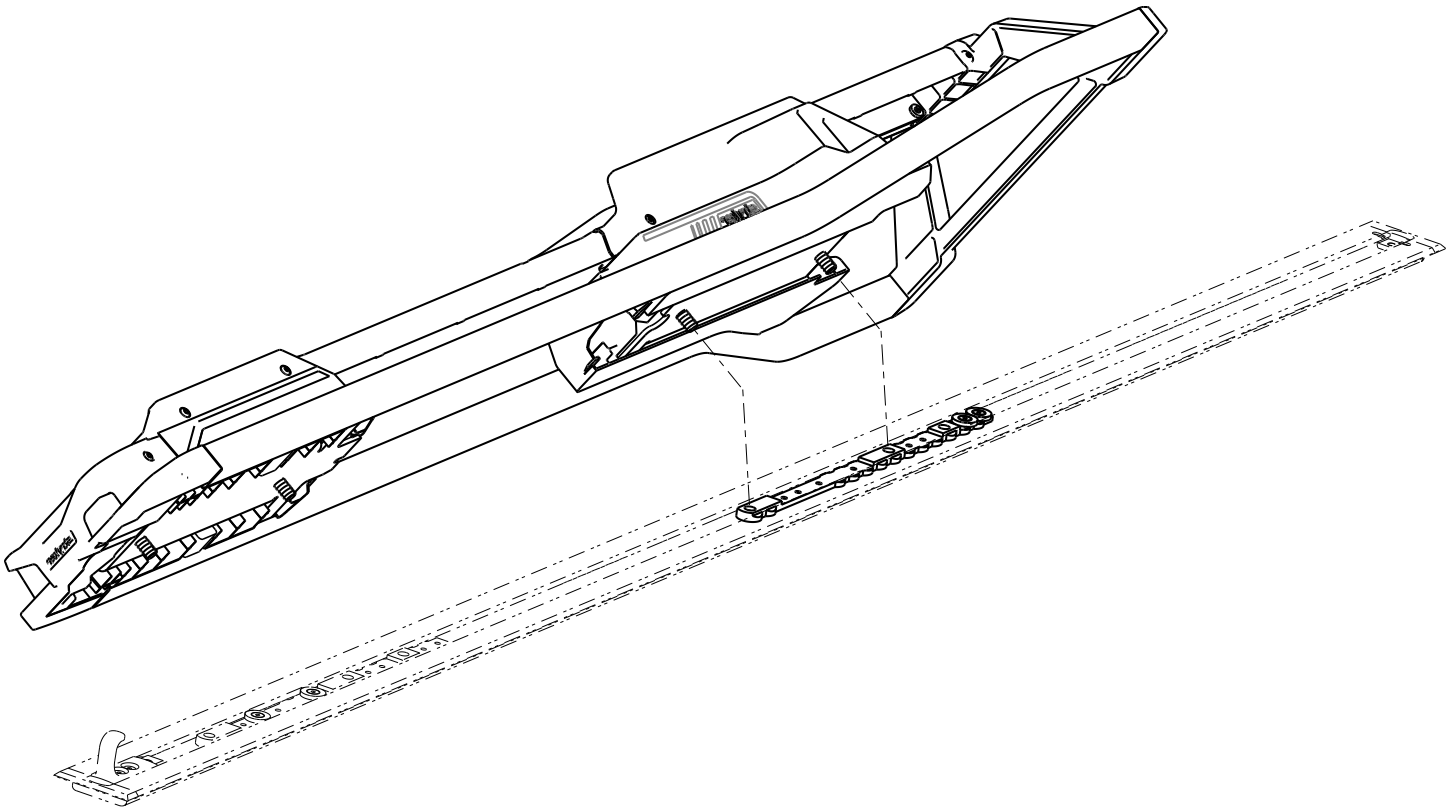

Figure 5 – Performance-LOAD alignment

2. If you are not planning to install the floor plate caps, skip to step 6.
3. To install the floor plate caps, measure the exposed pocket at the head end and the foot end of the floor plate to customize the floor plate cap, which is included with the floor plate assembly kit (6390-109-020). See *Installing the floor plate* (page 10).

Note - It is recommended that you add an additional 1 in. (2.5 cm) to the floor plate cap at the foot end to allow for overlap with **Performance-LOAD**.

4. Using a hack saw, cut two pieces of the floor plate cap to fit the measured length on both ends. The floor plate cap does not fit over the cleat. To cover a cleat, cut or remove the vertical tabs where they may interfere with the cleat (Figure 6).



Figure 6 – Cut floor plate caps

5. Using a rubber hammer, snap each floor plate cap into the floor plate (hook side first).

Note - To unsnap the floor plate cap, use a slotted screwdriver on the side of the cover with a raised edge.

6. If your system is not equipped with inductive charging, skip to step 15.
7. If your system is equipped with inductive charging, proceed to step 8.
8. Lay the excess wire into the floor plate pocket. Align the four holes with the mounting holes in the cleats.

CAUTION - Always place the wire inside the floor plate pocket, so the fastener assembly does not pinch the wire when you install the fastener assembly.

9. Using a T27 Torx driver, remove the four socket head cap screws (A) that secure the foot end cover assembly (B) to the transfer (Figure 7). Save the screws.
10. Using a T27 Torx driver, remove the two button head cap screws (C) that secure the foot end cover assembly to the foot end nose assembly (D) (Figure 7). Save the screws.

11. Remove the foot end cover assembly by sliding it toward the head end of the vehicle patient compartment. Save the foot end cover assembly.

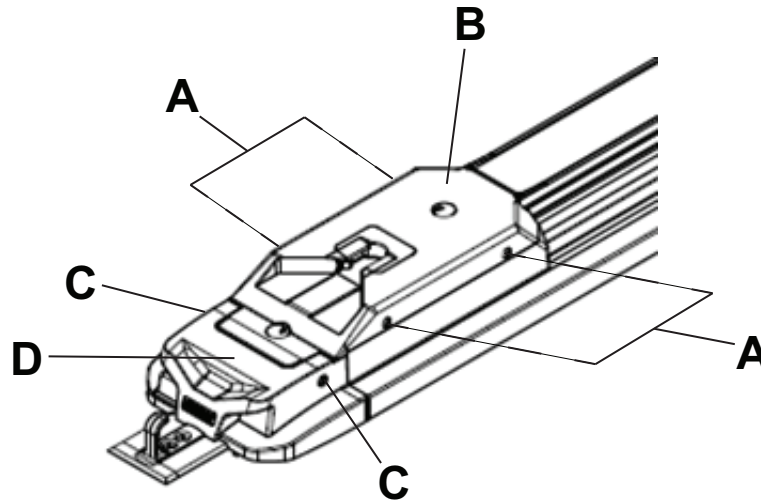

Figure 7 – Foot end cover assembly

12. Feed the anchor-to-vehicle cable (639000010135) into the **Performance LOAD** foot end cavity (Figure 8).

13. Connect the **Performance-LOAD** mating connector to the anchor-to-vehicle cable. Push them together until you hear a click.

14. Pull the excess vehicle-to-anchor cable out. The mated connectors should lie on the bottom of the cavity.(Figure 9).

15. Secure the vehicle-to-anchor cable with the cable clip (Figure 8).

Note - Rest the unused connector on top of the mated connectors.



Figure 8 – Push the connector into the cavity

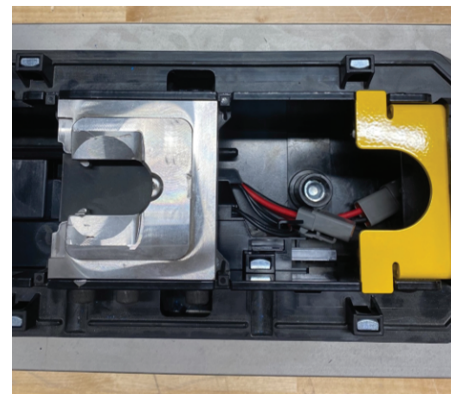

Figure 9 – Connector locations

Note - If you have a previously installed floor plate without the anchor-to-vehicle cable, measure either 3 in. or 7 in. toward the head end from the locator position E (Figure 10). Mark the location in the middle of the channel. This will be your electrical inlet location. See Installing the floor plate (6390-109-020) for instructions about how to connect the electrical.

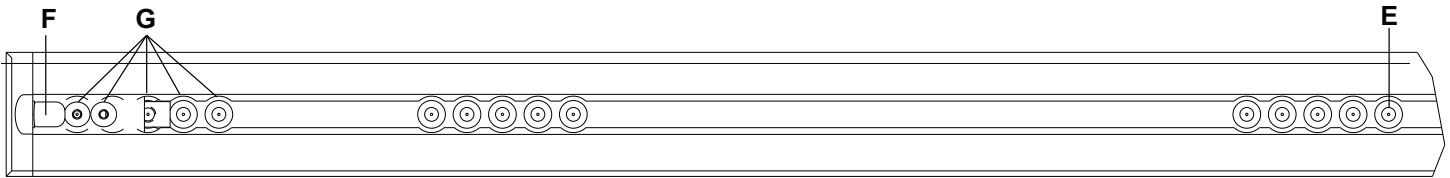

Figure 10 – Floor plate locator position - foot end

Note - The safety hook (F) and extra mounting hole locations (G) are shown for reference only (Figure 10). They are not used for **Performance-LOAD** installation.

16. Apply silicone sealant to the electrical rubber grommet to seal the electrical pass through.

WARNING - Always seal all gaps to the exterior of the vehicle to prevent exhaust fumes from entering the vehicle patient compartment.

17. Rotate the spin caps (H) a half turn to access the attached floor plate bolts that are under the caps (Figure 11).

Note - Do not fully tighten the floor plate bolts until all four bolts are aligned and started.

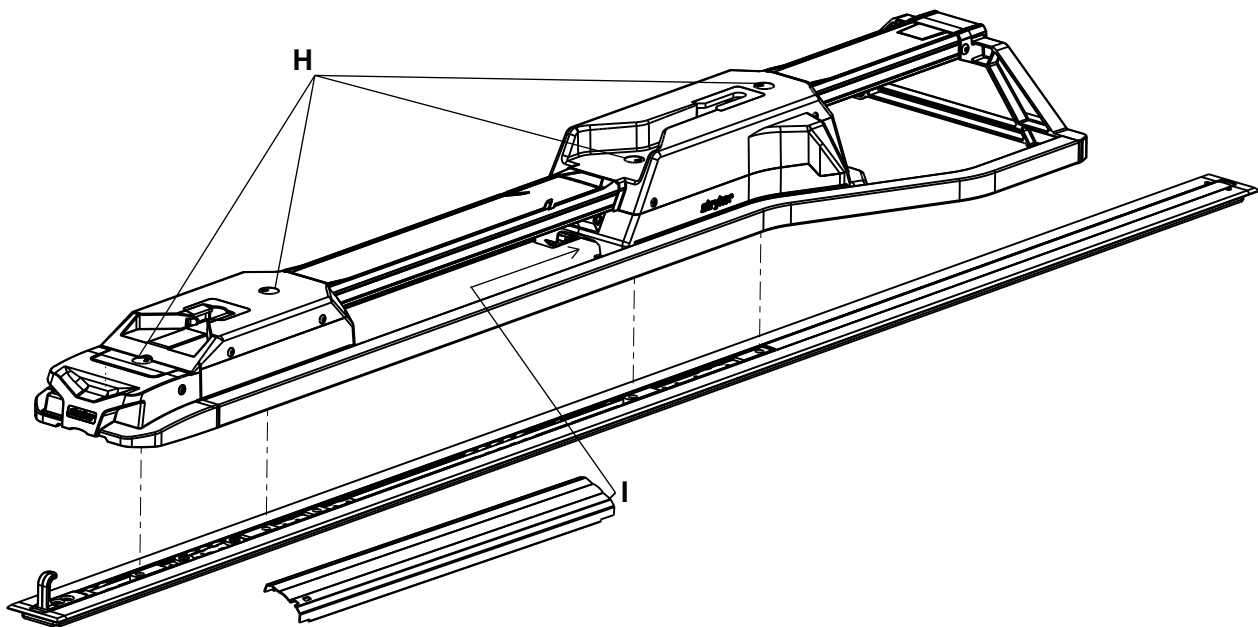

Figure 11 – Attach the fastener

18. Using a 3/8" hex wrench, install the attached floor plate bolt that is closest to the head end.
19. Using a 3/8" hex wrench, install the other three attached floor plate bolts (H) into the two cleats (Figure 11).
20. Using a torque wrench, tighten each floor plate bolt to 60±10 ft-lb.

WARNING - Always make sure that you tighten all four floor plate bolts to the recommended torque.

21. Close the spin caps.
22. Reverse steps 9-11 to reinstall the foot end cover assembly.
23. Insert the unnotched side of the center cover assembly (6392-001-011) (I) into the opening in the head end housing (Figure 11).
24. Drop the center cover assembly down to align with the floor plate.
25. Slide the center cover assembly into the opening in the foot end housing.
26. Continue to slide the center cover assembly toward the foot end until the post comes through the notch.

27. Complete the *Installation checklist* (page 24).

Installation checklist

Follow this checklist with a **Performance-LOAD** compatible **Power-PRO** cot (Model 6500, 6506, 6516) or **Performance-PRO** cot (Model 6086).

- _____ Make sure that you do not have any unused components after installation. Your **Performance-LOAD** system does not ship with any extra components. If you have any unused components after installation, call Stryker service.
- _____ Using a torque wrench, double check that all four attached floor plate bolts (A) are tightened 60+/-10 ft-lb. (Figure 11).
- _____ Visually check that all bolts and screws are properly tightened with no signs of protruding or missing fasteners.
- _____ Lift the vehicle bumper to the raised position, if equipped.
- _____ Load the **Performance-LOAD** compatible cot into **Performance-LOAD**.
- _____ Check that the head end pin slides freely into the head end interface. If not, call Stryker service.
- _____ Make sure that the cot is locked into **Performance-LOAD** by firmly pulling in and out and side to side on the foot end of the cot.
- _____ Press the release button at the foot end of **Performance-LOAD** and push toward the head end to unlock the fastener. Pull to remove the cot from the vehicle patient compartment. Make sure that the cot is released.
- _____ For Type II ambulances or if the cot center line is 17-1/2 in. or less from the vehicle wall, make sure that the optional wheel guide assembly (6390-027-000) is installed. Mark N/A if the wheel guide is not required.
- _____ If equipped with inductive charging, install a depleted cot battery into a **Performance-LOAD** compatible **Power-PRO** cot, load the cot into **Performance-LOAD**. Make sure that the cot battery LED indicator is flashing green to indicate that it is charging.

Product serial number:			
Installed by:		Date:	
Inspected by:		Date:	

Note - Maintain a copy of this record for at least seven years.

Operation

Operating guidelines

WARNING

- Always make sure of **Performance-LOAD** functionality before use. Failure may result in patient or operator injury.
 - Always use caution when you move around in the vehicle patient compartment to avoid tripping on **Performance-LOAD**.
 - Always use caution when you operate **Performance-LOAD** in adverse weather conditions (for example, rain, ice, snow).
 - Always operate the cot or **Performance-LOAD** only when all persons are clear of the mechanisms. Entanglement in powered cot or **Performance-LOAD** mechanisms can cause serious injury.
 - Always practice loading and unloading the cot with **Performance-LOAD** until operation of the product is fully understood. Improper use can cause injury.
 - Do not allow untrained personnel to assist in the operation of **Performance-LOAD**. Untrained technicians/personnel can cause injury to the patient or themselves.
 - Always use both hands when you handle the cot. **Performance-LOAD** is only an assisting device. Evaluate each situation to determine how to distribute and lift the weight that you are transporting.
 - Always use enough operators to handle the forces that are required to load or unload when you handle weights over 400 lb (181 kg). To increase safety, operators should load or unload on flat surfaces. For 36 in. (91 cm) vehicle deck heights, you may need to manually unload.
 - Always avoid extreme parking angles.
-
- Check **Performance-LOAD** for proper functionality before you start each shift.
 - Operate **Performance-LOAD** with the vehicle on a flat surface, if possible.
 - If you are unable to unload an occupied cot from the vehicle patient compartment, use a backboard to unload the patient.

Removing Performance-LOAD quickly

You can use the supplied tools to quickly remove **Performance-LOAD** from your vehicle patient compartment, if necessary.

To quickly remove **Performance-LOAD**:

1. Remove the center cover assembly (6390-001-011) from the head end housing.
2. Remove the hex wrench and removal tool extension from the center cover assembly (Figure 12).

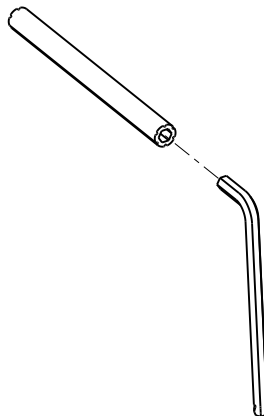

Figure 12 – Hex wrench and removal tool extension

3. Rotate the spin caps a half turn to access the attached floor plate bolts that are under the caps

4. Insert the small end of the hex wrench (0057-011-000) into the removal tool extension (6392-001-406) to loosen the four bolts.

Note - You cannot remove the four floor plate bolts as they are self contained within **Performance-LOAD**.

5. Carefully remove the fastener assembly from the floor plate assembly.
6. If equipped with inductive charging, disconnect the red wire from the red wire and the black wire from the black wire to disconnect the fastener assembly from the anchor-to-vehicle cable.

To reinstall, see *Installing Performance-LOAD* (page 19).

Checking the battery power level

Use the cot battery LED indicator to check the **SMRT Pak** power level. A charged **SMRT Pak**, in working condition, provides up to 25 calls with a 250 pound patient (actual results may vary). The 24 VDC **Power-PRO** system and the **SMRT Pak** is rated for 2.4 amp-hours of electric energy.

WARNING - Do not remove the battery when the cot is active.

CAUTION - Always charge the battery before you place the product into service. An uncharged or depleted battery may cause poor product performance.

To check the battery power level, press the retract (-) button on the cot control switch to activate the cot battery LED indicator. The cot battery LED indicator is located at the foot end control enclosure (shown as a battery symbol).

- The LED is solid green when the battery has a full charge or has an adequate battery power charge.

Note - For best results, use the **SMRT Pak** until the cot battery LED indicator changes from solid green to flashing amber.

- The LED flashes amber when you need to charge or replace the battery

Note - The cot battery LED indicator does not have to flash amber before you remove and replace the **SMRT Pak**, however, this is considered to be a best practice. You can remove and recharge the **SMRT Pak** at any time.

- The LED is a solid amber to indicate a battery error.

Note

- Only use Stryker approved batteries.
- If equipped, the powered cot fastener automatically charges the **SMRT Pak** battery. Automatic charging occurs when you lock the cot into the powered cot fastener (no cable or connectors required). The cot battery LED indicator flashes green for a moment to signify that it is charging.
- Automatic charging will only occur with **SMRT Pak** batteries.

Using a non-upgraded X-frame cot for a mass casualty incident

You can use some non-compatible cots, including most X-frame cots, in a mass casualty incident when equipped with the mass casualty option for **Performance-LOAD** and a manual Stryker cot fastener.

The loading and unloading operations are the same as the instructions for manual loading and unloading of a cot.

Unloading a compatible cot from Performance-LOAD

WARNING

- Always load or unload an occupied cot into a vehicle with a minimum of two trained operators.
- Always be ready to support the entire weight of the cot and patient when you unload a cot from the vehicle patient compartment.
- Always check for sheets, restraints, or debris that may catch in the cot transport wheels or load wheels.

- Do not extend the cot base while it is locked into **Performance-LOAD**.
-

1. Press and hold the release button at the foot end of the **Performance-LOAD** system and push the cot toward the head end of the vehicle patient compartment to relieve the load on the latch.
2. Grasp the cot frame at the foot end to pull the cot out of the vehicle patient compartment.

For Model 6500, Model 6506, and Model 6516 with **Performance-LOAD**:

- Operator 1: Grasp the cot frame at the foot end. While you support the weight of the cot, guide and pull the cot out of the vehicle patient compartment until the safety hook catches. Press and hold the extend (+) button on the cot control switch to extend the cot until the cot wheels rest on the ground.
- Operator 2: Grasp the outer rail to stabilize the cot. Unlatch the safety hook when the base is fully extended.

For Model 6086 with the **Performance-LOAD**:

- Operator 1: Grasp the cot frame. While you support the weight of the cot, guide and pull the cot out of the vehicle patient compartment until the safety hook catches.
- Operator 2: Grasp the base frame where indicated, lift slightly, and lower the base frame to its fully extended position while Operator 1 squeezes and holds the cot manual release. Make sure that the cot wheels are on the ground.
- Operator 1 (foot end): Release the cot manual release to lock the undercarriage into the extended position.
- Operator 2: Unlatch the safety hook when the base is fully extended.

Loading a compatible cot into Performance-LOAD

WARNING

- Always load or unload an occupied cot into a vehicle with a minimum of two trained operators.
 - Always allow occupants to enter the vehicle patient compartment after the compatible cot has been loaded into the vehicle patient compartment.
 - Always check for sheets, restraints, or debris that may catch in the cot transport wheels or load wheels.
-

CAUTION - Do not push the cot into the vehicle patient compartment until you fully retract the cot base.

1. Lift the vehicle bumper to the raised position, if equipped.
2. Fully extend and lock the cot retractable head section before you load the cot into the powered cot fastener.
3. Place the cot in a loading position (any position where the loading wheels meet the vehicle patient compartment floor height).
4. Roll the cot to the open vehicle patient compartment.
5. Push the cot forward until the loading wheels are on the vehicle patient compartment floor and the safety bar passes the safety hook.

Note - For maximum clearance to lift the base, pull the cot out until the safety bar is connected to the safety hook.

For Model 6500, Model 6506, and Model 6516 with **Performance-LOAD**:

- Grasp the cot frame at the foot end.
- Lift the foot end of the cot and press and hold the retract (-) button on the cot control switch to fully retract the cot undercarriage.

Note - The cot undercarriage will retract in less than three seconds.

For Model 6086 with **Performance-LOAD**:

- Operator 1 (foot end): Grasp the cot frame at the foot end. Squeeze and hold the cot manual release.
 - Operator 2 (side): Grasp the outer rail to stabilize the cot. Then, grasp the base frame. After the foot end operator has lifted the cot and squeezed the cot manual release, retract the undercarriage with one hand and hold it in place.
 - Operator 1 (foot end): Release the cot manual release to lock the undercarriage in the retracted position.
6. Push the cot into the vehicle patient compartment until the cot locks into the cot fastener.
 7. Make sure that the cot is locked into the cot fastener by firmly pulling in and out and side to side on the foot end of the cot.

Cleaning and disinfecting with wipes

For United States only. Confirm availability for your configuration or region. Call Stryker Customer Service: 1-800-327-0770.

Stryker's preferred wipes (2060-000-001 6" x 10" or 2060-000-002 9" x 12") include the following active ingredients:

- n-Alkyl (60% C14, 30% C16, 5% C12, 5% C18) dimethyl benzyl ammonium chloride - 0.154%
- n-Alkyl (68% C12, 32% C14) dimethyl ethylbenzyl ammonium chloride - 0.154%
- Isopropanol - 21.000%

Non-active ingredient: Ethylene Glycol Monobutyl Ether – < 3%

Note - For safety information, read the product label.

To clean or disinfect the external product surface:

1. To clean, wipe external surfaces with a fresh, clean wipe to remove all visible soils. Repeat as necessary until the product is clean.

Note

- Use as many wipes as necessary.
 - Complete step 1 before you disinfect.
2. To disinfect, wipe external surfaces with a fresh, clean wipe until wet. Allow the external surface to remain wet for two minutes at room temperature.
 3. Allow the product to dry before you return it to service.

Cleaning

WARNING - Always use any appropriate personal protective equipment while power washing to avoid inhaling contagion. Power washing equipment may aerate contamination.

CAUTION - Do not clean, disinfect, service, or perform maintenance while the product is in use.

The product is power washable. The product may show some signs of oxidation or discoloration from continuous washing. No degradation of the product's performance will occur from power washing as long as you follow the proper procedures.

- Follow the cleaning solution manufacturer's dilution recommendations exactly.
- Power wash with recommended cleaners. Hose down the product and towel dry the guide.
- Power wash the rails and interface plates with a hand held wand unit or wipe the product with a clean cloth and recommended cleaners.

Note - Water that gets into the **Performance-LOAD** system will drain through the drain tube to the underside of the vehicle.

Disinfecting

CAUTION

- Do not clean, disinfect, service, or perform maintenance while the product is in use.
-

In general, when used in concentrations recommended by the manufacturer, you can use either phenolic or quaternary (excluding **Virex**® TB) type disinfectants. Iodophor type disinfectants are not recommended for use because staining may occur.

The recommended disinfectants for this product's surfaces include the following:

- Quaternary (active ingredient - ammonium chloride) that contain less than 3% glycol ether
- Phenolic (active ingredient - o-phenylphenol)
- Chlorinated bleach solution (use up to UK disinfecting 10,000 ppm available chlorine (941 mL of a 5.25% sodium hypochlorite solution per 4000 mL of water)
- Alcohol (active ingredient - 70% isopropyl alcohol)

To wipe down the product with disinfectant between uses:

1. Follow the manufacturer's dilution recommendations exactly.
2. Apply the recommended disinfectant solution by spray or pre-soaked wipes.
3. Hand wash all surfaces of the product with the recommended disinfectant.
4. Disinfect all exposed surfaces. Pay attention to high contact areas.
5. Follow the disinfecting solution manufacturer's instructions for appropriate contact time and rinsing requirements.
6. Dry the product thoroughly before returning the product to service.

Avoid oversaturation. Do not allow the product to remain wet.

Follow the manufacturer's dilution recommendations for appropriate contact time and rinsing requirements. Follow the chemical manufacturer's guidelines for proper disinfecting.

Note - Always wipe with clean water and dry each product after disinfecting. Some disinfectants are corrosive in nature and may cause damage to the product. If you do not rinse and dry the product, you may leave a corrosive residue on the surface of the product. This corrosive residue could cause premature degradation of critical components. Failure to follow these disinfecting instructions may void your warranty.

Preventive maintenance

Establish and follow a maintenance schedule and keep records of the maintenance activity. Remove product from service before you perform the preventive maintenance inspection. You may need to perform preventive maintenance checks more often based on your level of product usage. Service only by qualified personnel.

Every month

Check	Routine
Foot end interface and head end interface	Clean debris

Every three months

Check	Routine
Loose fasteners	Replace if loose

Every twelve months

Check	Routine
All parts	Replace any worn parts, including covers, cot guides, and latch assembly, if necessary
Full functionality	See <i>Installation checklist</i> (page 24)

EMC information

Guidance and manufacturer's declaration - electromagnetic emissions		
<p>Performance-LOAD is intended for use in the electromagnetic environment specified below. The customer or the user of Performance-LOAD should assure that it is used in such an environment.</p>		
Emissions test	Compliance	Electromagnetic environment
RF Emissions CISPR 11	Group 2	The Performance-LOAD system must emit electromagnetic energy in order to perform its intended function. Nearby electronic equipment may be affected.
RF Emissions CISPR 11	Class A	The Performance-LOAD system is suitable for use in all establishments other than domestic and those directly connected to the public low-voltage power supply network that supplies buildings used for domestic purposes.

Recommended separations distances between portable and mobile RF communications equipment and Performance-LOAD			
<p>Performance-LOAD is intended for use in an electromagnetic environment in which radiated RF disturbances are controlled. The customer or the user of Performance-LOAD can help prevent electromagnetic interferences by maintaining a minimum distance between portable and mobile RF communications equipment (transmitters) and Performance-LOAD as recommended below, according to the maximum output power of the communications equipment.</p>			
Rated maximum output power of transmitter W	Separation distance according to frequency of transmitter m		
	150 kHz to 80 MHz $d=(1.2) (\sqrt{P})$	80 MHz to 800 MHz $d=(.18) (\sqrt{P})$	800 MHz to 2.5 GHz $d=(.35) (\sqrt{P})$
0.01	0.12	0.035	0.07
0.1	0.38	0.11	0.22
1	1.2	0.35	0.7
10	3.8	1.1	2.2
100	12	3.5	7
<p>For transmitters rated at a maximum output power not listed above, the recommended separation distance d in meters (m) can be estimated using the equation applicable to the frequency of the transmitter, where P is the maximum output power rating of the transmitter in watts (W) according to the transmitter manufacturer. Note 1: At 80 MHz and 800 MHz, the separation distance for the higher frequency range applies. Note 2: These guidelines may not apply in all situations. Electromagnetic propagation is affected by absorption and reflection from structures, objects, and people.</p>			

Guidance and manufacturer's declaration - electromagnetic immunity			
<p>Performance-LOAD is suitable for use in the electromagnetic environment specified below. The customer or the user of Performance-LOAD should assure that it is used in such an environment.</p>			
Immunity test	EN/IEC 60601 test level	Compliance level	Electromagnetic environment-guidance

Guidance and manufacturer's declaration - electromagnetic immunity

Electrostatic discharge (ESD) IEC 61000-4-2	±8 kV contact ±15 kV air	±8 kV contact ±15 kV air	Floors should be wood, concrete, or ceramic tile. If floors are covered with synthetic material, the relative humidity should be at least 30%.
Power frequency (50/60 Hz) magnetic field IEC 61000-4-8	30 A/m	30 A/m	Power frequency magnetic fields should be at levels characteristic of a typical location in a typical commercial or hospital environment.

Note: U_T is the a.c. mains voltage before applications of the test level.

Conducted RF IEC 61000-4-6	3 Vrms 150 kHz to 80 MHz	3 Vrms	Portable and mobile RF communications equipment should be used no closer to any part of Performance-LOAD , including cables, than the recommended separation distance calculated from the equation appropriate for the frequency of the transmitter.
Radiated RF IEC 61000-4-3	10 V/m 80 MHz to 2.5 GHz	10 V/m	Recommended separation distance $D = (.35) (\sqrt{P})$ 80 MHz to 800 MHz $D = (0.70) (\sqrt{P})$ 800 MHz to 2.5 GHz where P is the maximum output power rating of the transmitter in watts (W) according to the transmitter manufacturer and d is the recommended separation distance in meters (m). Field strengths from fixed RF transmitters, as determined by an electromagnetic site ^a should be less than the compliance level in each frequency range. ^b Interference may occur in the vicinity of equipment marked with the following symbol: 

Guidance and manufacturer's declaration - electromagnetic immunity

Note 1: At 80 MHz and 800 MHz, the higher frequency range applies.

Note 2: These guidelines may not apply in all situations. Electromagnetic propagation is affected by absorption and reflection from structures, objects, and people.

^a Field strengths from fixed transmitters, such as base stations for radio (cellular/cordless) telephones and land mobile radios, amateur radio, AM and FM radio broadcast, and TV broadcast cannot be predicted theoretically with accuracy. To assess the electromagnetic environment due to fixed RF transmitters, an electromagnetic site survey should be considered. If the measured field strength in the location in which **Performance-LOAD** is used exceeds the applicable RF compliance level above, the **Performance-LOAD** system should be observed to verify normal operation. If abnormal performance is observed, additional measures may be necessary, such as reorienting or relocating **Performance-LOAD**.

^b Over the frequency range 150 kHz to 80 MHz, field strengths should be less than 3 V/m.

stryker



Stryker Medical
3800 E. Centre Avenue
Portage, MI 49002
USA