

PURELL® CS6 TOUCH-FREE HAND SANITIZER DISPENSER DIMENSIONS

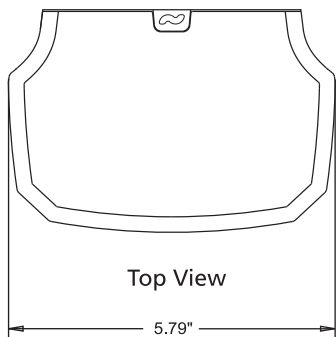

Use the dimensions provided to ensure adequate wall spacing and clearance for the unit.
Refill sold separately.

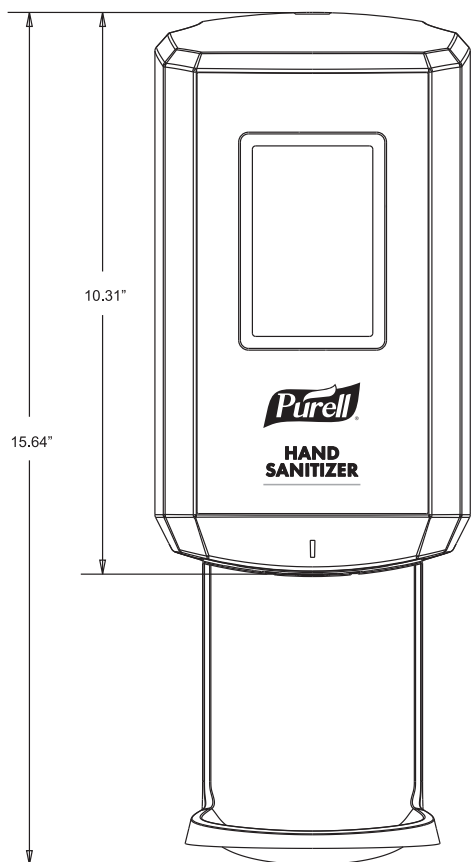

Front View

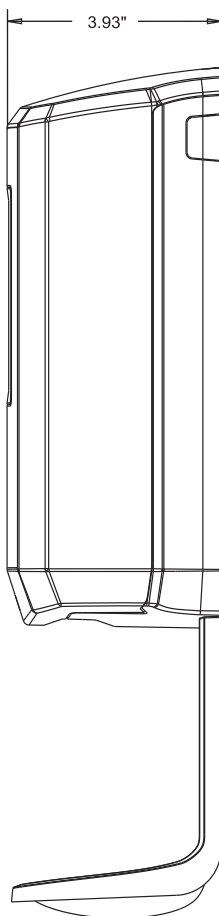

Side View

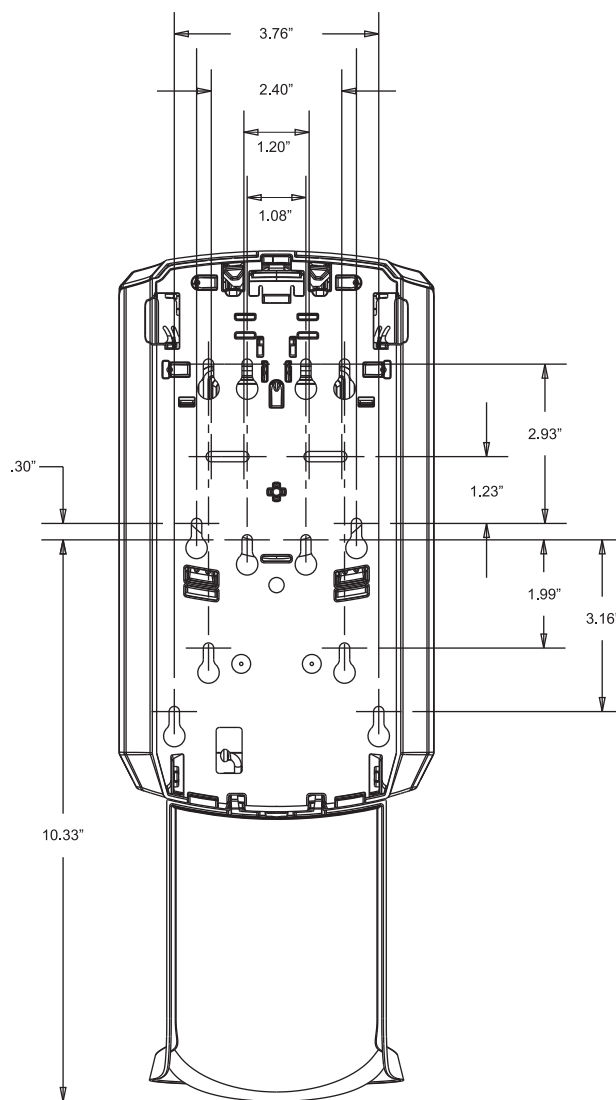

Back View



GOJO Industries, Inc.
One GOJO Plaza, Suite 500
P.O. Box 991 • Akron, OH 44309-0991
Tel: 1-330-255-6000 • Toll-free: 1-800-321-9647
Fax: 1-800-FAX-GOJO