

SERVICE MANUAL

Affinity® Three Birthing Bed and Affinity® Four Birthing Bed From Hill-Rom



Product No. P3700

**For Parts or Technical Assistance
USA (800) 445-3720 Canada (800) 267-2337
International: Contact your distributor.**

MAN272 REV 3

Affinity® Three Birthing Bed and Affinity® Four Birthing Bed Service Manual

Revisions

Revision	Pages Affected	Date
Original Issue		October, 2000
A	All	October, 2002
3	All	November 2006

MAN272 REV 3

© 2006 by Hill-Rom Services, Inc. ALL RIGHTS RESERVED.

No part of this text shall be reproduced or transmitted in any form or by any means, electronic or mechanical, including photocopying, recording, or by any information or retrieval system without written permission from Hill-Rom Services, Inc. (Hill-Rom).

Third Edition

First Printing 2000

Printed in the USA

Affinity® is a registered trademark of Hill-Rom Services, Inc.

Allen™ is a trademark of Industrial Fasteners, Inc.

CSA® is a registered trademark of Canadian Standards Association.

Freedom Hill™ is a trademark of Hill-Rom Services, Inc.

Hill-Rom® is a registered trademark of Hill-Rom Services, Inc.

Liberty Hill™ is a trademark of Hill-Rom Services, Inc.

Loctite® is a registered trademark of Loctite Corporation.

Mechlok® is a registered trademark of P.L. Porter Company.

Oilite® is a registered trademark of Beemer Precision, Incorporated.

Plexiglas® is a registered trademark of Rohm and Haas Company.

SideCom® is a registered trademark of Hill-Rom Services, Inc.

Slo-Blo® is a registered trademark of Littelfuse, Inc.

Stow and Go™ is a trademark of Hill-Rom Services, Inc.

Torx® is a registered trademark of Textron, Inc.

Underwriters Laboratories Inc.® is a registered trademark of Underwriters Laboratories Inc.

The information contained in this manual is subject to change without notice. Hill-Rom makes no commitment to update or keep current, the information contained in this manual.

The only product warranty intended by Hill-Rom is the express, written warranty accompanying the bill of sale to the original purchaser. Hill-Rom makes no other warranty, express or implied, and in particular, makes no warranty of merchantability or fitness for a particular purpose.

Additional copies of this manual can be obtained from Hill-Rom.

To order additional copies of this manual (MAN272), refer to the back cover for contact information. For countries not listed on the back cover, contact your distributor.

NOTE:

The back cover is a comprehensive list of Technical Support contact information for Hill-Rom. The product discussed in this manual may not be available in all of the countries listed.

Revisions

NOTES:

Table of Contents

Chapter 1: Introduction

Purpose	1 - 1
Audience	1 - 1
Reference Documents	1 - 1
Document Symbols	1 - 2
Introduction	1 - 3
Operating Precautions	1 - 3
Features	1 - 3
Head Section Inclination	1 - 3
Foot Section Inclination	1 - 4
High Low Sleeping Surface (Hilow)	1 - 4
Battery Back-up	1 - 4
Auxiliary Outlet (no longer available)	1 - 5
Automatic Tilt	1 - 5
Headboard	1 - 5
Docking/Wall Protection	1 - 5
Lockout Control Switch	1 - 5
Night Light	1 - 6
Foot Support Assemblies	1 - 6
Labor Grips	1 - 7
Siderails	1 - 7
Trend-Like Position Operation	1 - 8
CPR Release	1 - 8
The Integrated Air Support System	1 - 9
Mobility/Braking and Steer System	1 - 10
Siderails, Restraints, and Patient Monitoring	1 - 11
Dust Covers	1 - 12

Table of Contents

SideCom® Communication System	1 - 12
Air Supply System	1 - 13
Bed Positions	1 - 13
Specifications	1 - 16
Physical Description	1 - 16
Electrical Description	1 - 17
Automatic Night Light	1 - 18
Siderail Controls	1 - 19
P.C. Boards	1 - 19
Regulations, Standards, and Codes	1 - 20
Model Identification	1 - 20
Safety Tips	1 - 21
Bed Position	1 - 21
Siderails	1 - 21
Brake and Steer Pedals	1 - 21
Fluids	1 - 22
Water Mattress	1 - 22
Lockout Switch	1 - 22
CPR Release	1 - 22
Product Symbol Definitions	1 - 29
Warning and Caution Labels	1 - 32
Chapter 2: Troubleshooting Procedures	
Getting Started	2 - 1
Test Equipment	2 - 2
Initial Actions	2 - 3
Quick Reference Problem/Solution Matrix	2 - 3
Function Checks	2 - 4
Hilow System Functional Check	2 - 5
Trend-Like Position Functional Check	2 - 6
Head System Functional Check	2 - 7
Foot System Functional Check	2 - 8

Air System Functional Check	2 - 9
Other Bed Functional Checks	2 - 9
Final Actions	2 - 10
Hilow Drive Operation Failures	2 - 11
Hilow Up Malfunction	2 - 12
Hilow Down Malfunction	2 - 14
Head Drive Operation Failures	2 - 16
Head Up Malfunction	2 - 17
Head Down Malfunction	2 - 19
Foot Drive Operation Failures	2 - 21
Foot Up Malfunction	2 - 22
Foot Down Malfunction	2 - 24
Hilow Up Malfunction (When The Foot Section Is Lowered)	2 - 26
Brake Caster Malfunction	2 - 27
Bed Air Surface Malfunction	2 - 28
Night Light Does Not Illuminate	2 - 34
Siderail Mechanism Does Not Hold	2 - 35
Trend-Like Position Malfunction	2 - 36
Battery Back-up Malfunction	2 - 37
CPR Release Malfunction	2 - 39
Chapter 3: Theory of Operation	
Electrical System	3 - 1
Theory of Operation	3 - 6
Chapter 4: Removal, Replacement, and Adjustment Procedures	
Tool and Supply Requirements	4 - 1
Top Motor Cover	4 - 3
Removal	4 - 3
Replacement	4 - 4
Bottom Motor Cover	4 - 5
Removal	4 - 5
Replacement	4 - 6

Table of Contents

Hilow Drive Motor Assembly	4 - 7
Removal	4 - 7
Replacement	4 - 10
Hilow Limit Switch	4 - 11
Checking the Hilow Limit Switch	4 - 11
Adjustment	4 - 12
Head Drive Motor Assembly	4 - 15
Removal	4 - 15
Replacement	4 - 17
Adjustment	4 - 17
Foot Drive Motor Assembly	4 - 18
Removal	4 - 18
Replacement	4 - 20
Foot Limit Switch	4 - 21
Checking the Foot Limit Switch	4 - 21
Adjustment	4 - 22
CPR Release	4 - 25
Adjustment	4 - 25
Trend-Like Position Sensing Switch	4 - 27
Adjustment	4 - 27
Trend-Like Position Gas Spring	4 - 29
Removal	4 - 29
Replacement	4 - 30
Head Section Gas Spring and Damper (CPR Assist)	4 - 31
Removal	4 - 31
Replacement	4 - 32
Foot Support Module	4 - 33
Removal	4 - 33
Replacement	4 - 34
Adjustment	4 - 34
Night Light and Cable Assembly	4 - 36

Removal	4 - 36
Replacement	4 - 36
Mattress Assembly	4 - 37
Removal	4 - 37
Replacement	4 - 37
Labor Grips	4 - 38
Removal	4 - 38
Replacement	4 - 39
Foot Section (Lift Off)	4 - 40
Removal	4 - 40
Replacement	4 - 40
Foot Section (Slide Off)	4 - 42
Removal	4 - 42
Replacement	4 - 43
Line Voltage Fuses	4 - 44
Removal	4 - 44
Replacement	4 - 45
Battery Assembly	4 - 46
Batteries	4 - 46
Removal	4 - 46
Replacement	4 - 47
Battery Fuse	4 - 47
Removal	4 - 47
Replacement	4 - 48
Battery Charge Circuit	4 - 48
Adjustment	4 - 48
Bed Surface Air System Assembly	4 - 50
Removal	4 - 50
Replacement	4 - 52
Air System Manifold Assembly	4 - 53
Removal	4 - 53

Table of Contents

Replacement	4 - 53
Air System Control P.C. Board Assembly	4 - 54
Removal	4 - 54
Replacement	4 - 55
Logic Control P.C. Board Assembly	4 - 56
Removal	4 - 56
Modifying the Lockout Switch Cable	4 - 58
Replacement	4 - 60
Transformer Assembly	4 - 61
Removal	4 - 61
Replacement	4 - 62
Auxiliary Transformer Assembly (Affinity® Three Bed)	4 - 63
Removal	4 - 63
Replacement	4 - 64
Lockout Switch Assembly	4 - 65
Removal	4 - 65
Replacement	4 - 66
Siderail Assembly	4 - 67
Removal	4 - 67
Replacement	4 - 68
Patient Siderail (Inboard) P.C. Switch Board	4 - 69
Removal	4 - 69
Replacement	4 - 70
Caregiver Siderail (Outboard) P.C. Switch Board	4 - 71
Removal	4 - 71
Replacement	4 - 72
Central Braking System—P3700A Model Only	4 - 73
Removal	4 - 73
Replacement	4 - 76
Central Braking System—P3700B Model Only	4 - 77
Removal	4 - 77

Replacement 4 - 79

Caster Assembly 4 - 80

 Removal 4 - 80

 Replacement 4 - 81

 Brake and Steer Caster Adjustment 4 - 81

 Brake Caster Adjustment 4 - 82

Stow and Go™ Foot Section Wire Form 4 - 83

 Removal 4 - 83

 Replacement 4 - 85

Chapter 5: Parts List

Service Parts Ordering 5 - 1

Exchange Policy 5 - 3

 In-Warranty Exchanges 5 - 3

 Out-of-Warranty Exchanges 5 - 3

Warranty 5 - 5

Recommended Spare Parts 5 - 7

Caster Module 5 - 9

Base Module—P/N63951S (Sheet 1 of 2) (Affinity® Three Bed). 5 - 10

Base Module—P/N63951S (Sheet 2 of 2) (Affinity® Three Bed). 5 - 14

Main Frame Module 5 - 16

Siderail Module 5 - 20

Electronics Module (Sheet 1 of 3) 5 - 24

Electronics Module (Sheet 2 of 3) 5 - 27

Electronics Module (Sheet 3 of 3) 5 - 28

Electrical Cable Routing (Sheet 1 of 2) 5 - 30

Electrical Cable Routing (Sheet 2 of 2) 5 - 32

Sleep Deck Module (Sheet 1 of 3) 5 - 34

Sleep Deck Module (Sheet 2 of 3) 5 - 38

Sleep Deck Module (Sheet 3 of 3) 5 - 40

Label Module (Sheet 1 of 4)—P3700A 5 - 44

Label Module (Sheet 2 of 4)—P3700A 5 - 46

Table of Contents

Label Module (Sheet 3 of 4)—P3700A	5 - 48
Label Module (Sheet 4 of 4)—P3700A	5 - 49
Foot Support Module—P3700A	5 - 50
Calf Support Module—P3700A	5 - 54
Air Module	5 - 56
Headboard	5 - 58
Caster Module—P3700B	5 - 60
Base Module—P3700B (Sheet 1 of 2)	5 - 62
Base Module—P3700B (Sheet 2 of 2)	5 - 66
Sleep Deck—P3700B	5 - 68
Foot Support Module—P3700B	5 - 70
Calf Support Module—P3700B	5 - 73
Label (Sheet 1 of 4)—P3700B	5 - 76
Label (Sheet 2 of 4)—P3700B	5 - 78
Label (Sheet 3 of 4)—P3700B	5 - 80
Label (Sheet 4 of 4)—P3700B	5 - 82

Chapter 6: General Procedures

Cleaning	6 - 1
Steam Cleaning	6 - 2
Cleaning Hard to Clean Spots	6 - 2
Disinfecting	6 - 2
Draping the Mattress	6 - 2
Caring for the Wood Components	6 - 3
Servicing the Bed	6 - 4
Component Handling	6 - 5
P.C. Boards	6 - 5
Lubrication Requirements	6 - 6
Preventive Maintenance	6 - 7
Inspecting the Pivot Point Fasteners	6 - 7
Inspecting the Foot Supports	6 - 8
Preventive Maintenance Schedule	6 - 10

Preventive Maintenance Checklist	6 - 13
Using Loctite® Adhesive	6 - 15
Purple Loctite® Adhesive #222 (P/N SA4842)	6 - 16
Blue Loctite® Adhesive #242 (P/N SA3618)	6 - 16
Red Loctite® Adhesive #262 (P/N SA4841)	6 - 16
Red Loctite® Adhesive #271 (P/N SA4840)	6 - 16
Chapter 7: Accessories	
Accessories	7 - 1
Labor Bar (P3613)	7 - 3
Installation	7 - 3
Adjustment	7 - 4
Removal	7 - 4
Oxygen Tank Holder (P276)	7 - 5
Installation	7 - 5
Removal	7 - 5
Telescoping Calf Supports (P35745A) or Telescoping Full Leg Supports (P7634C)	7 - 6
Installation	7 - 6
Adjustment	7 - 7
Removal	7 - 7

NOTES:

Chapter 1

Introduction

Purpose

This manual provides requirements for the Affinity® Three Birthing Bed and Affinity® Four Birthing Bed normal operation and maintenance. It also includes parts lists (in chapter 5) for ordering replacement components.

Audience

This manual is intended for use by facility-authorized personnel only. Failure to observe this restriction can result in severe injury to people and serious damage to equipment.

Reference Documents

For more information (such as operating instructions, features, and product symbols), refer to the “*Affinity® Three Birthing Bed and Affinity® Four Birthing Bed User Manual (USR025)*.”

Document Symbols

This manual contains different typefaces and symbols to make the content easier to read and understand:

- Standard text—used for regular data.
- **Boldface text**—emphasizes a word or phrase.
- **NOTE:**—sets apart special data or important instruction clarification.
- WARNING or CAUTION



- A WARNING identifies situations or actions that may have an effect on patient or user safety. To ignore a warning could cause patient or user injury.
- A CAUTION identifies special procedures or precautions that persons must obey to help prevent equipment damage.

- CAUGHT HAZARD WARNING



- CHEMICAL HAZARD WARNING



- ELECTRICAL SHOCK HAZARD WARNING



Introduction

The Affinity® Three Birthing Bed and Affinity® Four Birthing Bed are intended to be used as a birthing bed within the acute care Labor and Delivery Unit. The Affinity® Three Birthing Bed and Affinity® Four Birthing Bed are a three-motor birthing type bed with multiple articulation features (see “Bed Position” on page 1-21). A variety of options are available including nurse call, air system, night light, auxiliary outlets, and siderail controls. See “Features” on page 1-3 for additional information concerning some of the Affinity® Three Birthing Bed and Affinity® Four Birthing Bed features.

NOTE:

Any reference in this manual to a side of the bed is from the point of view of a patient lying in the bed on her back. This information appears in the manual wherever it is pertinent.

Operating Precautions

Before operating the bed, be sure that you have read and understand in detail the contents of this manual. It is important that you read and strictly adhere to the safety precautions (see “Safety Tips” on page 1-21).

For additional operating precautions for the bed and its accessories, refer to the *Affinity® Three Birthing Bed and Affinity® Four Birthing Bed User Manual* (USR025).

Features

The bed incorporates three independent motors to raise and lower the following bed features:

- Bed height
- Foot section
- Head section (The seat section automatically tilts with head section operation.)

These functions are governed by P.C. board logic and controlled by the use of the siderail bed controls or an optional hand-held, six-function pendant.

Head Section Inclination

The bed is mechanized so that the patient or attendant may elevate the head section by pressing a switch. The head up/head down switches are momentary

contact type switches and are pictorially labeled to indicate their function. The switches are fixed in relation to the head section and within easy access of both the occupant and attendant, regardless of the degree of inclination.

Foot Section Inclination

The bed is mechanized so that the patient or attendant may elevate the foot section by pressing a switch. The foot up/foot down switches are momentary contact type switches and are pictorially labeled to indicate their function. The switches are fixed in relation to the head section and within easy access of both the occupant and attendant, regardless of the degree of inclination.

High Low Sleeping Surface (Hilow)

The bed is mechanized so that an attendant can raise or lower the sleeping surface to facilitate examination or bed ingress or egress. The hilow up/down switches are momentary contact type switches and are pictorially labeled to indicate their function. The switches are fixed in relation to the head section and face toward the attendant position only. The hilow up/down switches are not accessible to the occupant.

Battery Back-up

The bed is designed with battery back-up as a standard feature. The battery allows the hilow, foot, and head motors to be activated from the siderail controls without power being supplied to the bed. In addition, the battery powers the nurse call function, but it does not power any other bed functions.

Battery Back-up LED Indicators

- ON = Battery status is operational or when bed is plugged into the appropriate power source.
- FLASHING = Battery needs charging.
- OFF = Battery is discharged below the level required to run the motors.



CAUTION:

Remove the battery if the bed will not be in service for extended periods of time. Failure to do so could result in damage to the life of the battery or damage to the bed. Contact the appropriate maintenance personnel.

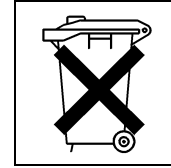
If the battery has been completely discharged, it may take up to 36 hours to recharge to operational status.

To ensure the battery is always charged, plug the bed into the appropriate power source whenever possible. If the battery is discharged or unplugged, the bed is still functional when plugged into the appropriate AC receptacle.

Disposal

Power comes from a lead acid battery, which needs to be disposed of properly according to your local regulations.

For assistance in disposing of the battery, contact your maintenance technician.



Pb

Auxiliary Outlet (no longer available)

The two auxiliary outlets provide electrical power for accessories.

Automatic Tilt

As the head section is raised, the seat gradually tilts up from 0 to 15 degrees. As the head section is lowered, the seat gradually returns to a flat position.

Headboard

The headboard is mounted to a metal frame. The headboard has built-in handles, which aid in steering control and increase mobility. The headboard is removable.

Docking/Wall Protection

Standard roller bumpers, located at the head end of the bed, protect walls and headwall systems from damage.



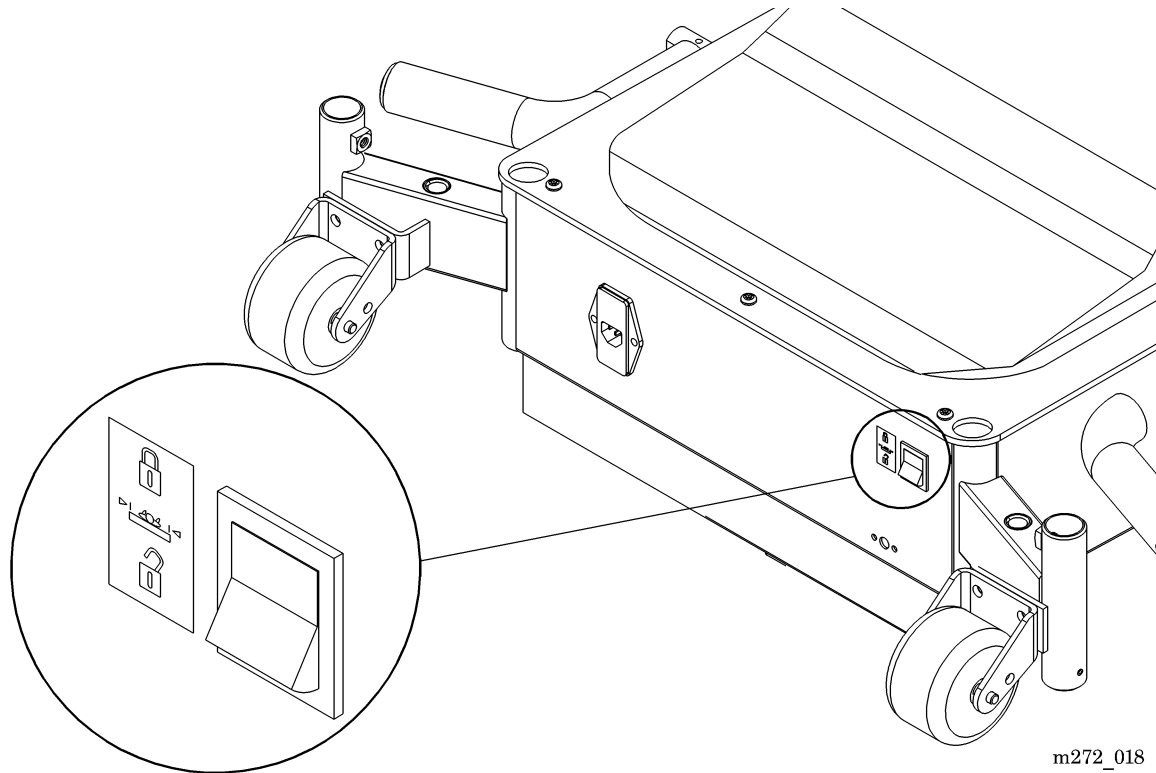
CAUTION:

Do not position the head of the bed against a wall or beneath any fixtures. This is to prevent damage due to the arcing motion of the bed while the bed is being raised and lowered.

Lockout Control Switch

The lockout control switch is located at the head end of the bed on the frame (see figure 1-1 on page 1-6). This control is used to deactivate the patient (inboard) and caregiver (outboard) siderail controls.

Figure 1-1. Lockout Switches



Night Light

The night light is located under the bed. A photocell control automatically turns the light on when the room darkens and turns it off when it gets brighter.

Foot Support Assemblies

The bed is equipped with built-in foot support assemblies designed to remain on the unit during normal usage. The assemblies can be simultaneously positioned up or down, through use of the motor-powered, foot section yoke. This foot section yoke controls the overall height up and down. Each foot support can be independently positioned by using the mechanical release latch at the end of the foot supports.

The following positional adjustments can be made:

- To position the patient's legs, squeeze the release lever and rotate the foot support. The foot support rotates upward and outward from 0° to 85°.
- To return to the storage position, squeeze the release latch again, and return the supports to the desired position.

Each foot support is attached to the bed and can only be removed by the appropriate personnel.

Labor Grips

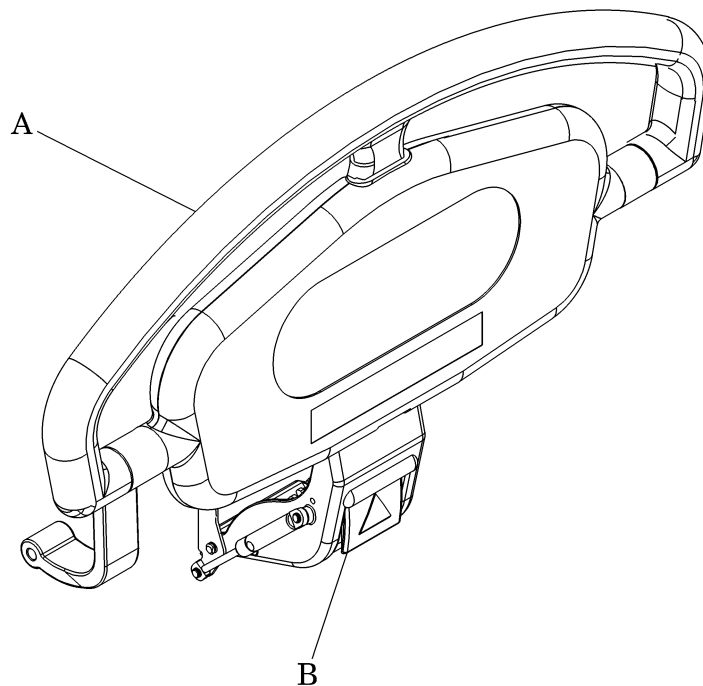
To raise the labor grip, grasp the grip, and rotate it up from under the bed until it clicks. This signals that it has locked into position. Ensure that the labor grip is properly locked by giving it a tug.

To lower the labor grip, pull the release handle, and lower the grip under the bed.

Siderails

To raise the siderails (A), grasp the top center of the siderail, and pull out and up from beneath the bed (see figure 1-2 on page 1-7). Rotate the siderail upward until it clicks. The clicking sound signals that the siderail has locked into position. Ensure that the siderail is up and properly locked into position by giving it a gentle tug.

Figure 1-2. Siderails



m272_029

To lower/store the siderail, pull the release handle (B), and allow the siderail to lower into the down or storage position.

The siderail stores in a position that does not extend outward from the width of the bed. This feature aids in preventing transfer gaps when two beds are placed side by side.

Trend-Like Position Operation

Trend-Like positioning to 8° is achieved mechanically from any bed height position by depressing one of two Trend-Like position handles. Trend-Like position handles are located near the head end of the bed under the head section. Depressing either one of the handles releases gas-assisted springs (cylinders) and allows for easy positioning.

To place the sleep surface in Trend-Like position, push down on the handle, and guide the bed to the desired angle. If the desired Trend-Like position cannot be achieved because the bed is too low, the bed's hilow function will automatically raise the bed until the proper position is reached.

To return the bed to the level position, pull up on the handle. Mechanical limits stop the travel when the sleep surface is level. Quickly release it when the bed is in the desired position.

Depending on the position of the head section and the weight of the patient, the amount of activation force required to place the bed in or out of the Trend-Like position varies. For example, with a patient occupying the bed and the head section raised to 45°, the bed will more easily go out of Trend-Like position, versus going into the Trend-Like position. With a patient occupying the bed and the head section in the flat position, the bed will more easily go into the Trend-Like position, versus going out of the Trend-Like position.

NOTE:

The bed must be in the flat (level) position and out of the Trend-Like position, for the hilow to work properly.

CPR Release

The head section has a releasing mechanism for rapid emergency lowering. The release mechanism requires intentional action to release it. The bed mechanism recognizes the de-coupling and automatically lowers the head and seat section; then it recouples the head and seat mechanism. This ensures proper head section lifting after the emergency.

A CPR release handle is located on either side of the bed, beneath the head section. To operate, pull the CPR handle and hold. With a patient in the bed, the head section will lower to a flat position within approximately 7 seconds.

The Integrated Air Support System

The integrated air support system allows the patient or attendant to select the desired level of firmness in the lumbar and seat sections of the mattress. Both the patient and attendant can control these functions from the siderail. The lumbar bladder, when fully inflated, appears as a large round bump in the mattress. The seat bladder, when fully inflated, does not have a specific appearance. Proper operation of the seat bladder is best determined by lying on the bed and activating the seat inflate function.

Seat Section Mattress

The seat section mattress has auto-inflate and auto-deflate functions. The appropriate button need be pressed only once to achieve full inflation or deflation of the mattress.

Seat Section Mattress Auto-Inflate or Deflate Control

To automatically inflate or deflate the seat section, press the caregiver seat inflate button (plus sign) or caregiver seat deflate button (minus sign) once. The seat section will inflate or deflate for approximately 20 to 25 seconds and then automatically stop.

If a complete inflation or deflation cycle is not necessary, press the caregiver seat inflate or caregiver seat deflate button a second time to stop the inflation or deflation.

Back Section Lumbar Mattress

The back section lumbar mattress does not have auto-inflate or auto-deflate functions. The appropriate button must be pressed and held until the desired inflation is attained.

Back Section Lumbar Mattress Control

To inflate the back section, press and hold the back inflate button (plus sign) until the desired firmness is attained.

To deflate the back section, press and hold the back deflate button (minus sign) until the desired softness is attained.

Mobility/Braking and Steer System

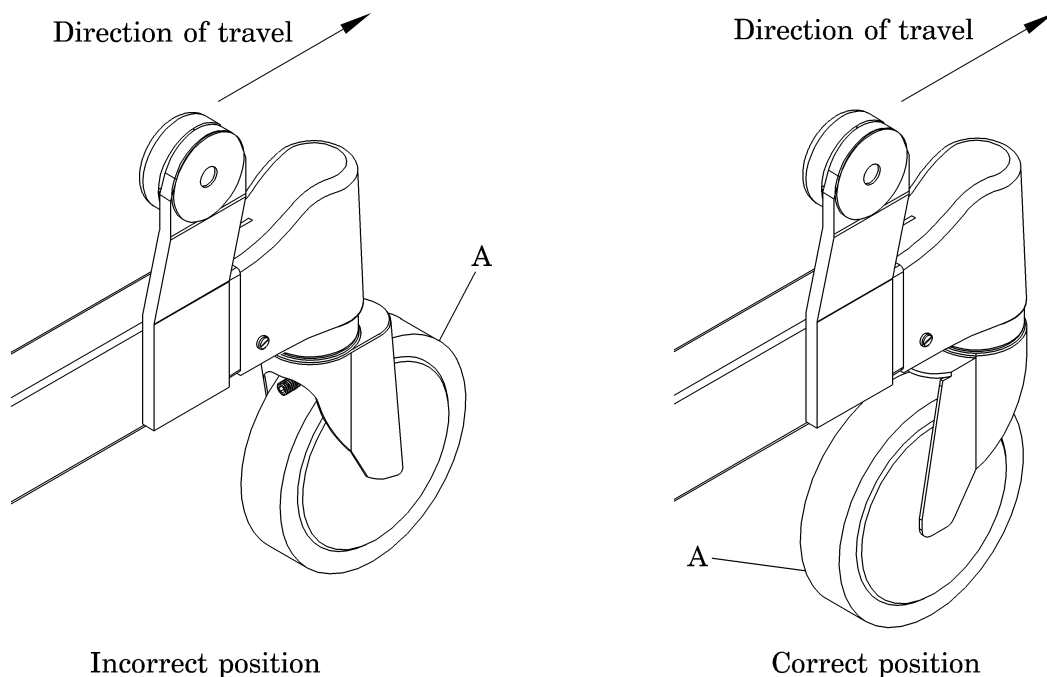
The bed is mounted on four precision-bearing swivel casters. Each caster has a molded polyurethane wheel with a diameter of 6" (15 cm) or 8" (20 cm) (Affinity® Three Birthing Bed only). Wheels have precision-bearing axles and swivels for high mobility. They are easily removed for cleaning or replacing.

The caster braking system is activated by foot pedals located on either side of the bed to enable one foot to lock two casters (wheels and swivels). Activation of the steer system locks the swivel on one caster (steer lock on the foot end) to enable easy steering of the bed, on the Affinity® Four Birthing Bed, all four casters lock. The steer system is operated by foot pedals located on either side of the bed. The foot pedals are located in convenient, accessible locations on both sides of bed and are clearly identified. The brake pedal is designated by an orange dot, and the steer pedal is designated by a green dot.

Brake and Steer Pedals

Placing the brake/steer pedal in steer locks the left side, foot end caster into a position that is parallel to the bed. When transporting the bed, the caster should trail the direction of travel (see figure 1-3 on page 1-10). This trailing position is when the center of the caster's wheel axle is behind the caster stem during transport.

Figure 1-3. Steer Caster Position



m272_030

**WARNING:**

A bed that is transported with the steer caster locked in an incorrect position can drift from side to side during transport. Personal injury or equipment damage could occur.

If the caster is leading the direction of travel, reposition it. Do this by placing the brake/steer pedal in neutral, swiveling the caster 180 degrees, and placing the brake/steer pedal back in the steer position.

Siderails, Restraints, and Patient Monitoring

The bed is equipped with head section siderails as standard equipment. They can be placed in the up or down position. In the down position, the rails store under the frame of the bed providing a *zero transfer gap* for safe surface-to-surface transfer and better patient access. The bed is configured so that the following functions may be included as part of the siderails:

- Patient and attendant head and foot actuators
- Hilow actuators (attendant only)
- Nurse call
- Entertainment center actuators (lighting, TV, UTV, and radio)
- Mattress controls

The siderails should always be in a full upright position and latched when a patient is unattended. When raising the siderails, an audible *click* indicates that the siderail is completely raised and locked in place.

We recognize that certain healthcare situations may indicate the need for specialized siderail configurations. In response to this need we offer, upon request, several siderail accessories.

Siderails are intended to be a reminder, **not a patient restraining device**. Appropriate medical personnel should determine the level of restraint necessary to ensure that a patient remains safely in bed. Consult the restraint manufacturer's instruction for use to verify the correct application of each restraining device.

Whenever medicated or confused patients are involved, Hill-Rom recommends the following minimum actions:

- Develop guidelines for all such patients that indicate:
 - Which patients should be restrained and the appropriate restraint to utilize.
 - The proper method to monitor a patient, whether restrained or not, including time interval, visual check of restraint, etc.
- Develop training programs for all caregivers concerning the proper use and application of restraints.
- Maintain the bed at its lowest position whenever a caregiver is not in the room.

Dust Covers

All bed mechanisms are enclosed for protection from damage, aid in infection control, and patient room housekeeping efficiencies.

SideCom® Communication System

Every bed with siderail controls is pre-wired to accommodate the SideCom® Communication System. The SideCom® Communication System enables integration of the backlit nurse call, entertainment (radio and TV), and lighting in the siderails. The optional Universal TV is also available.

Nurse Call (Optional)

On beds equipped with the optional nurse call feature, use the nurse call button to place a call to the nurse call system. Above the nurse call button, the call indicator light illuminates on the patient's siderail controls, indicating a call has been made.

Siderail Communication Watchdog System

Beds equipped with the SideCom® Communication System include a feature called the siderail communication watchdog system. It sends a nurse call if for any reason the siderail controls do not communicate properly with the bed.

Air Supply System

Major components in the air supply system include:

- Air compressor
- Manifold solenoid block
- Mattress drive circuit board
- Air mattress

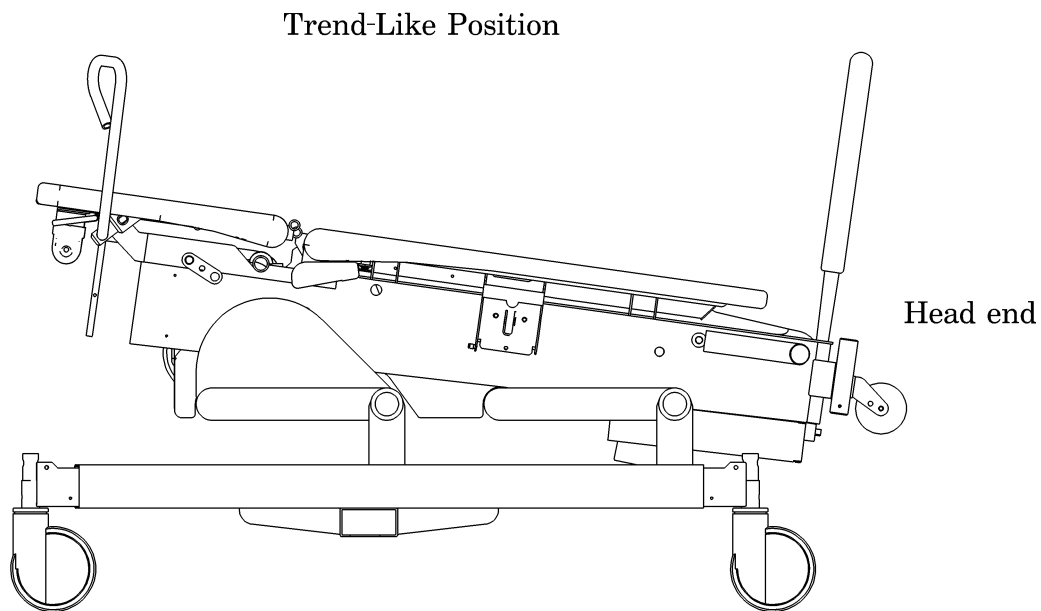
Bed Positions

The bed has three sections: head, seat, and foot.

The bed positions are shown as follows:

- Trend-Like Position (see figure 1-4 on page 1-13)
- Head Position (see figure 1-5 on page 1-14)
- Foot Position (see figure 1-6 on page 1-14)
- Hilow Positions (see figure 1-7 on page 1-15)

Figure 1-4. Trend-Like Position



m272_014

Figure 1-5. Head Position

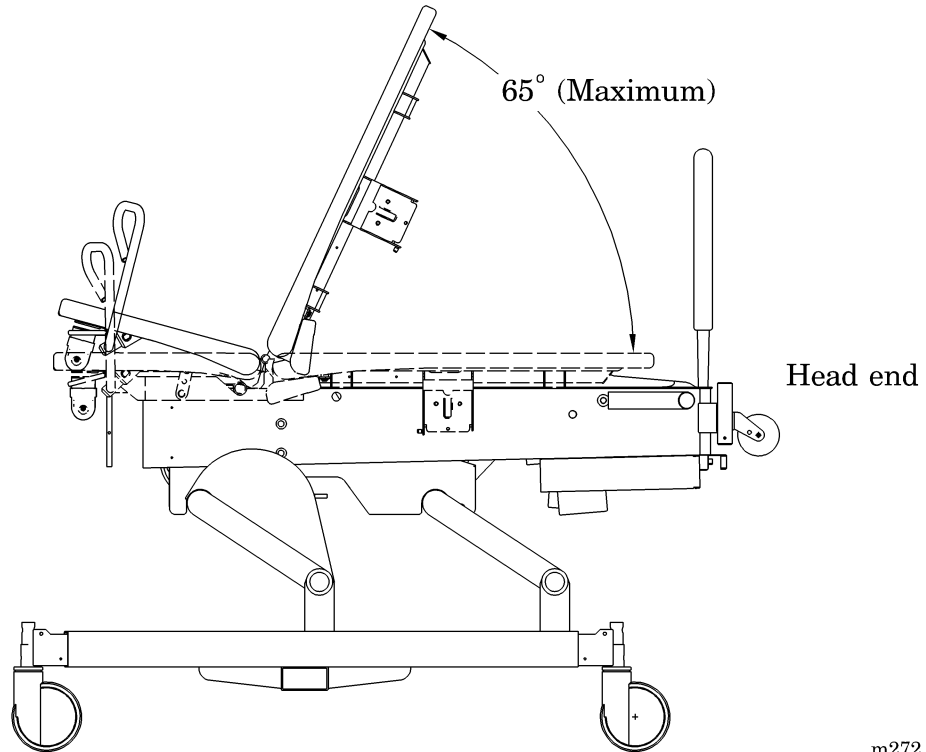


Figure 1-6. Foot Position

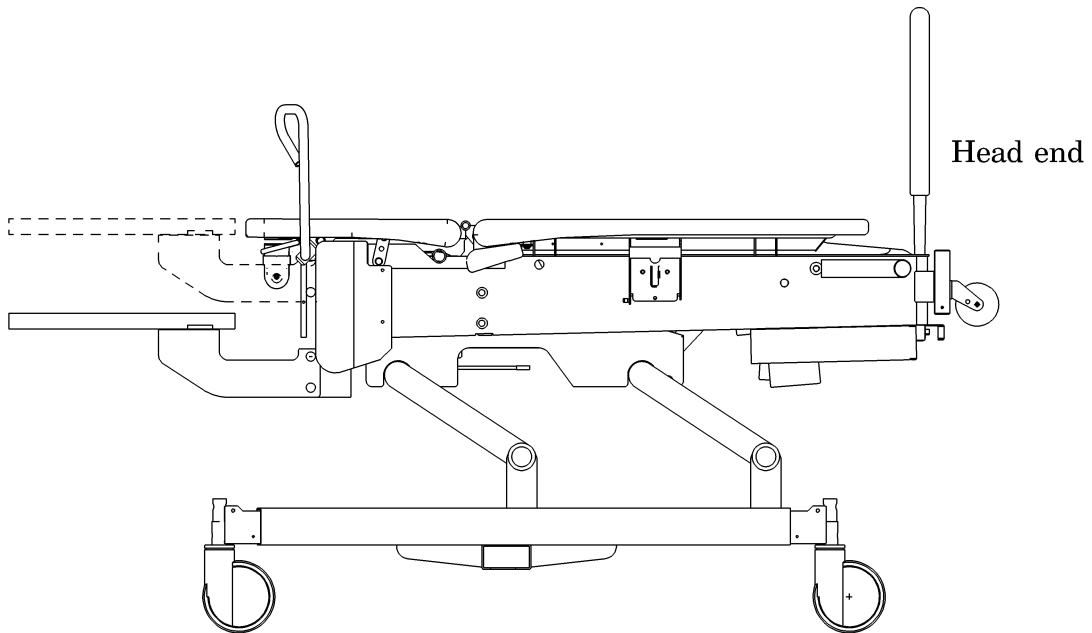
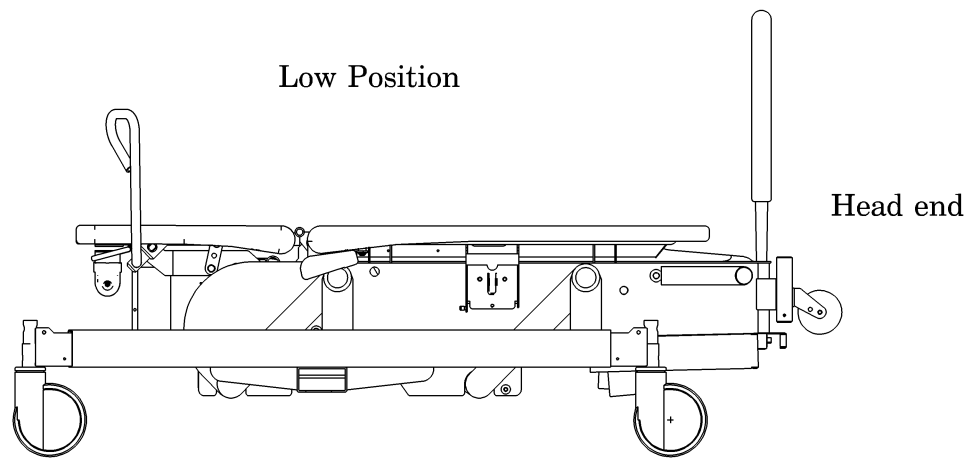
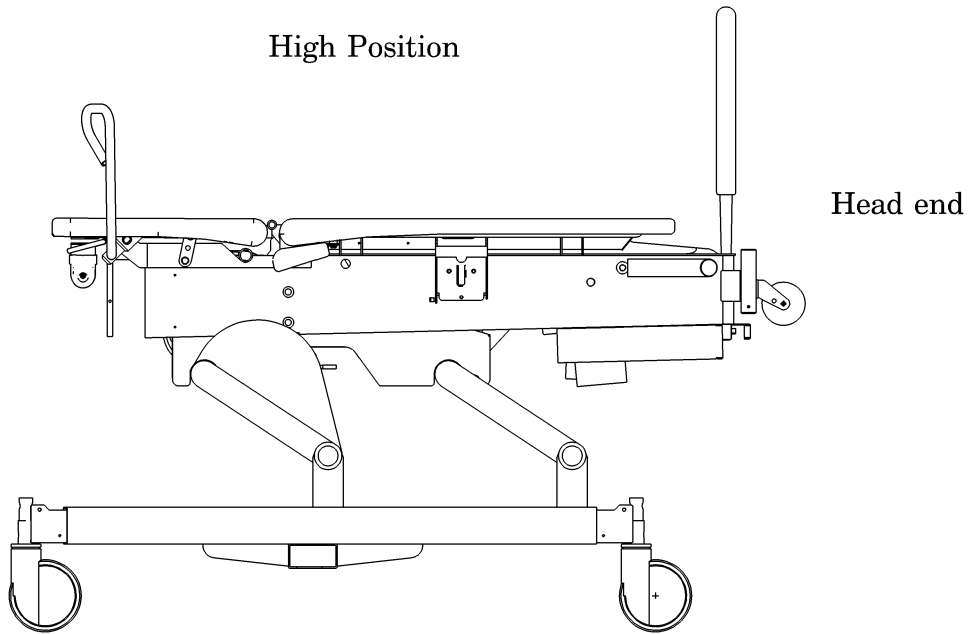


Figure 1-7. Hilow Positions



m272_015

Specifications

Physical Description

For bed specifications, see table 1-1 on page 1-16.

Table 1-1. Specifications

Feature	Dimension
Total Length	90" (229 cm)
Length from roller bumpers to break in seat section	61 7/8" (157 cm)
Length from break in the seat section to end of bed	28 1/8" (71 cm)
Maximum Width (siderails stored)	36" (91 cm)
Maximum Width (siderails up)	39" (99 cm)
Maximum Headboard Height	52" (132 cm)
Maximum Siderail Height (without mattress)	14 3/4" (37.47 cm)
Minimum Under-Bed Clearance	5" (13 cm), 3" 7.6 cm) for Stow and Go™ Beds
Wheel Base	50" x 29" (127 cm x 74 cm)
Mattress Width	35" (89 cm)
Mattress Length	78" (198 cm)
Mattress Thickness (head/seat)	4" (10 cm)
Mattress Thickness (foot)	3" (8 cm)
Detachable Power Cord, IEC 320/interface	US, 84" (213 cm)/international, 98" (249 cm)
Caster Size	6" (15 cm) or 8" (20 cm) (Affinity® Three Birthing Bed only)
Total Weight (maximum)	480 lb (218 kg)
Head Section Inclination (maximum)	65°
Seat Section Inclination (maximum)	15°
Bed Height Range	18" (46 cm) to 34" (86 cm)
Bed Height Range (with mattress)	22" (56 cm) to 38" (97 cm)
Trend-Like position (maximum)	8°

(Continued on next page.)

Table 1-1. Specifications (cont'd.)

Feature	Dimension
Bed Lift capacity (maximum safe working load)	500 lb (227 kg)
Foot Section Weight capacity (maximum)	400 lb (181 kg)
Head Section Lift capacity (maximum)	200 lb (91 kg)
Maximum Height of Seat Section (in Trend-Like position)	40" (102 cm)

Table 1-2. Environmental Conditions for Transport and Storage

Condition	Range
Temperature	-40°F (-40°C) to 158°F (70°C)
Relative humidity	95% non-condensing
Pressure	15 "Hg (50 kPa) to 31 "Hg (106 kPa)

Table 1-3. Environmental Conditions for Use

Condition	Range
Temperature	59°F (15°C) to 104°F (40°C) ambient temperature
Relative humidity range	10% to 85% non-condensing

Electrical Description

Table 1-4. Mains Power Requirements

Condition	Range
Rated voltage	120V AC/230V AC
Power/input	4 A/2 A
Frequency	50/60 Hz

Table 1-5. Fuse Specifications

Condition	Range
Air system fuse (air system optional)	2 A, 250 V~, 5 x 20 mm, UL 198G Fast Acting
Battery fuse	10 A, 32 V~, ATO
Mains fuses (120 V bed model)	4 A, 125 V~, 5 x 20 mm, UL 198G Slo-Blo® ^a or equivalent
Mains fuses (230 V bed model)	2 A, 250 V~, 5 x 20 mm, IEC127 Sheet III, Time Delay

a. Slo-Blo® is a registered trademark of Littelfuse, Inc.

Table 1-6. Electrical Leakage

Condition	Range
Ground resistance	< 0.20Ω
Leakage current	< 100μA for 120V models < 150μA for 230V models

The electrical power system is insulated from the metal parts of the bed. No additional electrical components, such as isolation transformers, are required to make this bed meet applicable electrical codes. All patient support surfaces are fully grounded through a three-wire power cord having a hospital-grade, 3-prong, grounded plug.

Each bed is factory-tested for complete operation with and without a load. Each bed is tested for insulation integrity and micro-current leakage.

All electrical components of this bed have been approved by Underwriters Laboratories Inc.®¹ (UL) and Canadian Standards Association (CSA®²) for this application.

Automatic Night Light

The bed is equipped with a night light that automatically activates as the ambient light decreases. The light illuminates the foot fall area under the bed.

1. Underwriters Laboratories Inc.® is a registered trademark of Underwriters Laboratories Inc.

2. CSA® is a registered trademark of Canadian Standards Association

Siderail Controls

Patients and attendants operate the various functions of this bed by means of finger-touch switches located in a convenient fixed position on the siderails at both sides of the bed. These controls move with the head section for easy access and visual contact regardless of the head section elevation. The control switches are electronically interlocked to prevent electrical damage to the motor caused by contradictory direction signaling.

Head

Head section operating controls, identified by graphic symbols, are visible and accessible to both the patient and the attendant. The up/down travel of the head section is controlled by separate momentary type switches.

Foot

Foot section operating controls, identified by graphic symbols, are visible and accessible to both the patient and the attendant. The up/down travel of the foot section is controlled by separate momentary type switches.

On the original version of the bed, the foot section travel pauses when it reaches the flat or bed level position, indicating the bed is in the level position. Travel then proceeds to the desired position if the foot section switch remains actuated. The new version of the bed does not have this pause feature.

Hilow

The hilow controls, identified by graphic symbols, are visible and accessible only to the nurse/attendant. The up/down travel of the sleep deck is controlled by separate momentary type switches.

Lockout

This bed has the capability of locking out the inboard and outboard hilow, head, and foot functions if so prescribed by the attending physician. The lockout switch is located at the head end of the bed's main frame. The lockout function interrupts the patient/attendant siderail controls until the lockout switch is turned off.

P.C. Boards

All P.C. board functions are tested at the completion of circuit board assembly and at final bed assembly. A line transient filter is included to protect the boards from excessive line surges.

Regulations, Standards, and Codes

The bed is designed and manufactured according to equipment classifications and the standards in table 1-7 on page 1-20.

Table 1-7. Regulations, Standards, and Codes

Technical and Quality Assurance Standards	EN 60601-1 and amendments UL 2601-1 CSA C22.2 No. 601.1 IEC 60601-2-38 IEC 60601-1-2 EN ISO 9001 and EN 46001
Equipment Classifications per EN 60601-1	Class I equipment, internally powered equipment
Degree of Protection Against Electric Shock of the Applied Part	Type B
Degree of Protection Against Ingress of Water	IPX2
Degree of Protection Against the Presence of Flammable Anaesthetic Mixtures	Ordinary equipment, not for use in a flammable atmosphere
Mode of Operation	Continuous operation with intermittent loading, 3 minutes ON/30 minutes OFF
Classification according to Directive 93/42/EEC	Class I

Model Identification

For bed model identification, see table 1-8 on page 1-20.

Table 1-8. Model Identification

Model Number	Description
P3700A	Affinity® Three Birthing Bed
P3700B	Affinity® Four Birthing Bed

Safety Tips

Train and educate your staff on the hazards associated with electric beds. Do not allow personnel to have their entire body below the sleep surface and within the confines of the bed. Unplug the bed from its power source and engage the lockout control prior to cleaning or servicing it. If service personnel need to get under the bed, they must block up the hilow portion as an added precaution. Ensure that the foot section is properly mounted to the yoke.

We urge you to incorporate these safety tips into your procedures for the safety of both patients and staff.

Bed Position

To reduce the severity of falls by patients, always leave the bed in the low position when the patient is unattended.

Siderails

Leave the siderails fully up and locked when the patient is left unattended. When raising the siderails, be sure that you hear the click that signals the up and locked condition. Give the siderails a tug to check that they are firmly in position.

Siderails are intended as a reminder, not a restraint device. Appropriate medical personnel should determine the level of restraint necessary to ensure a patient remains safely in bed.

Brake and Steer Pedals

Always keep the casters in the brake position when the bed is occupied. Patients often use the bed for support when getting in or out of bed, and serious injuries can result if the bed moves. After brakes are set, rock the bed gently to ensure that they are locked.

Put the casters in the steer mode when moving the bed. This will make the bed easier to position or transport.

Fluids

When massive spills occur in the area of the P.C. boards, motors, or transformers, immediately:

1. Unplug the bed from its power source.
2. Take care of the patient.
3. Clean the fluid from the bed.
4. Have maintenance check out the bed completely. Fluids can short out controls, making the bed inoperable or cause the bed to operate erratically. Component failure caused by fluids can even cause the bed to operate without warning, causing injury.
5. Do not place the bed back into service until it is unquestionably dry and tested safe to operate.

Water Mattress

The excessive weight associated with water mattresses puts an undue stress on the motor drives. In most cases, the patient's weight plus the water mattress weight exceeds the recommended bed capacity. Even more important is the fact that water mattresses are subject to rupture, which would allow large amounts of water to come into contact with the electrical components of the bed. We recommend not using water mattresses.

Lockout Switch

Whenever a patient or visitor should be restricted from operating the siderail controls, activate the lockout switch located at the head end of the bed (on the main frame). The lockout switch is for the convenience of the staff and the safety of the patient. Use the lockout switch when appropriate.

CPR Release

Only healthcare professionals should use the emergency CPR release. The two release handles are located under the head section of the bed near the seat section.

To activate the CPR release, pull the handle away from the bed. Continue to pull out on the handle until the head section is flat. When this is complete, attend to the patient. The bed will automatically flatten the head and seat sections and reset itself to be ready to use after the emergency.

**WARNING:**

A bed that is transported with the steer caster locked in an incorrect position can drift from side to side during transport. Personal injury or equipment damage could occur.

**WARNING:**

Only facility-authorized maintenance personnel should troubleshoot the bed. Troubleshooting by unauthorized personnel could result in personal injury or equipment damage.

**WARNING:**

Unplug the bed from its power source and disconnect the battery back-up before checking ohms/resistance measurements. Failure to disconnect line voltage to the bed can damage the VOM and cause equipment damage or personal injury.

**WARNING:**

Refer to your VOM owner's manual for complete and detailed information regarding the operation of your VOM. Failure to do so could result in personal injury or equipment damage.

**WARNING:**

You must use the 2" x 4" pieces of lumber to support the bed. The bed will fall during this procedure if not supported. Failure to do so could result in personal injury or equipment damage.

**WARNING:**

Prop up the head section before removing the cotter pins and clevis pins. Failure to do so could result in personal injury or equipment damage.

**WARNING:**

You must use the 2" x 4" pieces of lumber to support the foot yoke. The foot yoke will fall during this procedure if not supported. Failure to do so could result in personal injury or equipment damage.



WARNING:

The head end of the main frame is supported by the two Trend-Like position gas springs. Any servicing will require that a support device be placed just beneath the head end of the main frame. Failure to do so could result in personal injury or equipment damage.



WARNING:

Do not attempt to remove the gas spring with the head section fully raised and the spring compressed. Lower the head section until the cylinder of the gas spring is free in the slide bracket of the main frame, and support the head section securely before removing the cotter pins and clevis pins. Failure to do so could result in personal injury or equipment damage.



WARNING:

Failure to properly mount the foot section to the yoke latches could result in equipment damage or personal injury.



WARNING:

Failure to properly mount the foot section to the yoke slide brackets could result in equipment damage or personal injury.



WARNING:

Adhere to all electrical safety precautions when servicing the bed's electrical system. Failure to do so could result in personal injury or equipment damage.



WARNING:

Ensure that the bed is stable before removing the caster. Failure to do so could result in personal injury or equipment damage.



WARNING:

Follow the product manufacturer's instructions. Failure to do so could result in personal injury or equipment damage.



WARNING:

Adhere to the *Infection Control Policies and Procedures* from Hill-Rom.

Failure to do so could result in the spread of infection.

**WARNING:**

Powered bed mechanisms can cause serious injury. Operate the bed only with persons clear of mechanisms. Failure to do so could result in personal injury or equipment damage.

**WARNING:**

Unplug the bed from its power source and engage the lockout control during routine maintenance or cleaning. Refer to the *Affinity® Three Birthing Bed and Affinity® Four Birthing Bed User Manual (USR025)* and specific sections in this service manual for additional precautions. Failure to do so could result in personal injury or equipment damage.

**WARNING:**

Ensure that all electrical/mechanical loads are removed prior to maintenance/repair of the bed's drive system or other mechanical assemblies. Failure to do so could result in personal injury or equipment damage.

**WARNING:**

Visually inspect the bushings annually. If wear is apparent, replace them. Failure to do so could result in personal injury or equipment damage.

**WARNING:**

Only facility-authorized personnel should perform preventive maintenance on the bed. Preventive maintenance performed by unauthorized personnel could result in personal injury or equipment damage.

**WARNING:**

Inspect the pivot point fasteners semi-annually. Failure to do so could result in personal injury or equipment damage.

**WARNING:**

Use primers with adequate ventilation. Avoid skin contact and

prolonged or repeated breathing of vapors. Do not allow primers to be trapped under rings, watch bands, etc. Observe all directions on the primer can. Failure to do so could result in personal injury.



WARNING:

Avoid excessive or repeated skin contact with the liquid. Repeated contact with the liquid could result in personal injury.



WARNING:

The labor bar is intended to be used in the prescribed manner only. Failure to use this product as outlined may result in personal injury or equipment damage.



WARNING:

Insufficient tightening will allow the cradles to slip and lose their original position. Personal injury could occur.



WARNING:

The supports are intended to be used in the prescribed manner only. Failure to use this product as outlined may result in personal injury or equipment damage.



SHOCK HAZARD:

Unplug the unit from its power source. Failure to do so could result in personal injury or equipment damage.



SHOCK HAZARD:

The voltage in the electrical system presents an electrical shock hazard. Perform standard electrical service procedures before attempting service within the P.C. board enclosure. Adhere to all electrical safety precautions when servicing the bed's electrical system. Failure to do so could result in personal injury or equipment damage.



SHOCK HAZARD:

Do not expose the unit to excessive moisture which would allow liquid to pool. Personal injury or equipment damage could occur.

**CAUTION:**

Remove the battery if the bed will not be in service for extended periods of time. Failure to do so could result in damage to the life of the battery, or damage to the bed. Contact the appropriate maintenance personnel.

**CAUTION:**

Do not position the head of the bed against a wall or beneath any fixtures. This is to prevent damage due to the arcing motion of the bed while the bed is being raised and lowered.

**CAUTION:**

Ensure that the night light is not damaged when the bed is being lowered. Failure to do so could result in equipment damage.

**CAUTION:**

Do not pull on the mattress material when unfastening the mattress retaining snaps. Unfasten the mattress retaining snaps at the snap location. Failure to do so could result in equipment damage.

**CAUTION:**

Ensure that the fuse housing is properly oriented for the voltage rating (110-120V or 220-240V) on the bed that you are servicing. Failure to do so could result in equipment damage.

**CAUTION:**

Do not cut or remove the cable ties that secure the battery leads to the electronics pan. This ensures the proper connection of the batteries during the replacement procedure. Possible equipment damage could occur if the cable ties are removed.

**CAUTION:**

To prevent component damage, ensure that your hands are clean, and **only** handle a P.C. board by its edges. Failure to do so could result in equipment damage.



CAUTION:

For shipping and storage, place the removed P.C. board in an antistatic protective bag. Failure to do so could result in equipment damage.



CAUTION:

Support the siderail during the removal procedure. Failure to do so could result in equipment damage.



CAUTION:

Ensure that the siderail does not drop when the pins are removed. Failure to do so could result in damage to the wiring going to the siderail.



CAUTION:

Do not use harsh cleansers or detergents such as scouring pads and heavy-duty grease removers, or solvents such as toluene, xylene, and acetone. Equipment damage could occur.



CAUTION:

Ensure that the metal platform is dry before placing the mattress back onto the bed. Failure to do so could result in equipment damage.



CAUTION:

Mattress damage caused by improper draping and/or cleaning procedures is not covered by warranty.



CAUTION:

Standard OB packs and paper drapes will not keep the sheets dry.



CAUTION:

When handling electronic components, wear an antistatic strap. Failure to do so could result in component damage.









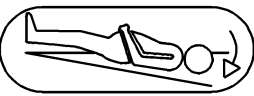
CAUTION:

Do not use silicone-based lubricants. Equipment damage could occur.

Product Symbol Definitions

For Affinity® Three Birthing Bed symbol definitions, see table 1-9 on page 1-29.

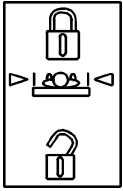

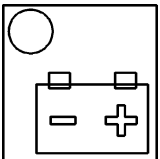
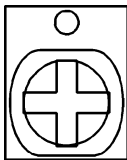


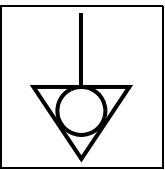
Table 1-9. Product Symbol Definitions

Symbol	Description
	Type B applied part according to EN 60601-1.
IPX2	According to IEC 529
	CAUTION: Consult accompanying documents.
	Conforms to the European Medical Device Directive 93/42/EEC.
	Certified by Underwriters Laboratories Inc.® in accordance with UL2601-1, CAN/CSA C22.2 NO.601.1, EN 60601-1, IEC 601-2-38 and IEC 601-1-2.
	Approval mark from VDE Prüf-und-Zertifizierungsinstitut in accordance with EN 60601-1, IEC 601-2-38, and IEC 601-1-2.
	CPR function—Identifies the release lever that can be used to manually drop the inclined head section, so that cardiopulmonary resuscitation can be performed without delay.
	Trend-Like function

a. Underwriters Laboratories Inc.® is a registered trademark of Underwriters Laboratories Inc.

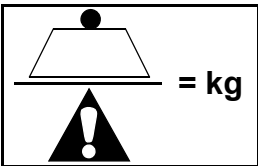


(Continued on next page.)

Table 1-9. Product Symbol Definitions (cont'd)

Symbol	Description
	<p>Lockout control label—The switch in the up position indicates the lockout control is on. The switch in the down position indicates the lockout control is off.</p>
	<p>Lockout control status—when the lockout control status light is on, the lockout function is activated.</p>
	<p>Battery charge status</p>
	<p>Nurse call</p>
	<p>Identifying mains fuse</p>
	<p>Alternating current</p>
	<p>Equipotentiality</p>

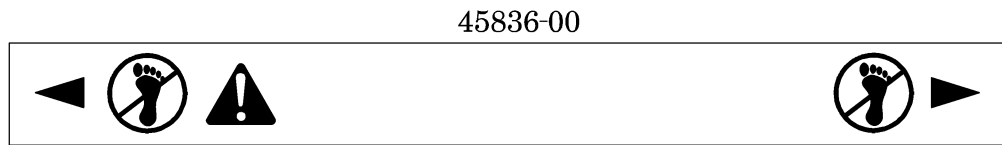
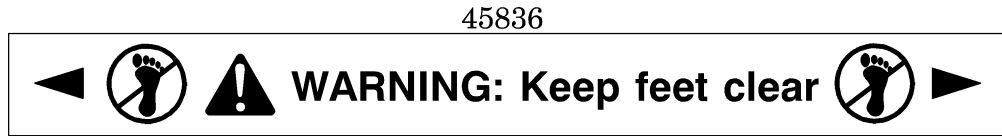
(Continued on next page.)

Table 1-9. Product Symbol Definitions (cont'd)

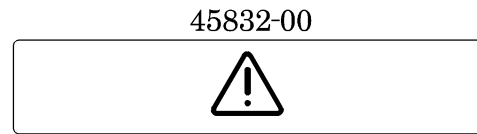
Symbol	Description
	Safe working load
	Electric shock hazard
	Keep feet clear of this area. Potential for injury.

Warning and Caution Labels

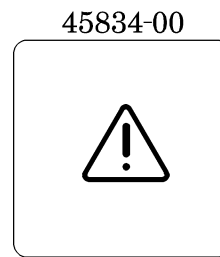
Figure 1-8. Warning and Caution Labels (Sheet 1 of 3)



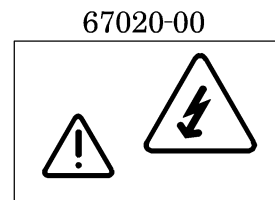
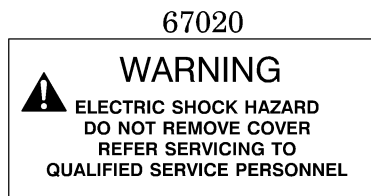
(Warning symbol, keep feet clear)



(Warning symbol, danger is present)



(Warning symbol, danger is present)





(Warning symbol, electric shock hazard)


m272a007


Figure 1-9. Warning and Caution Labels (Sheet 2 of 3)

65833

<p>WARNING</p> 	<p>POWERED BED MECHANISMS CAN CAUSE SERIOUS INJURY. OPERATE BED ONLY WITH PERSONS CLEAR OF MECHANISMS.</p>	<p>CAUTION; USE OXYGEN ADMINISTERING EQUIPMENT OF THE NASAL, MASK OR VENTILATOR TYPES.</p>
<p>CAUTION</p> 	<p>UNPLUG BED DURING SERVICE OR CLEANING. REFER TO SERVICE MANUAL AND IN-SERVICE MANUAL FOR ADDITIONAL PRECAUTIONS.</p>	<p>CAUTION; EXTERNAL CIRCUITS PROVIDED BY HOSPITAL FACILITIES AND INTERFACING WITH SIDECON, HAVE NOT BEEN INVESTIGATED BY UL. PERIODIC TESTS OF LEAKAGE CURRENT SHOULD BE PERFORMED ON THESE CIRCUITS TO VERIFY VALUES ARE WITHIN SAFE AND ACCEPTABLE LIMITS FOR LOCATION OF USE.</p>


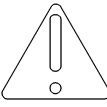
65833-00



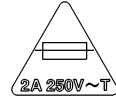
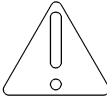


(International)

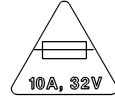
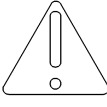
65831

65831-01


65831-02

(International)


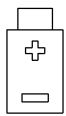
(Autofuse)

65832



12V ~, 1.7 A

66870

(Battery, Caution)

63609



WARNING

FOOT SECTION MUST BE LOCKED IN PLACE.
PULL TO ENSURE LATCH IS ENGAGED.

63609-00



(Warning symbol, foot section must be locked in place)

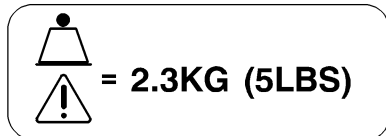
67091

WARNING

PROPER GROUNDING IS ACHIEVED ONLY WHEN BED IS CONNECTED TO "HOSPITAL GRADE RECEPTACLE"

m272a006

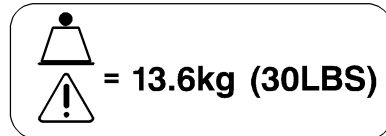
Figure 1-10. Warning and Caution Labels (Sheet 3 of 3)



67090-01 Anesthesia Screen



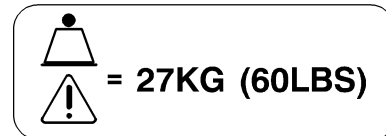
67090-07 Infusion Support System



67090-02 Arm Board



67090-08 Labor Bar



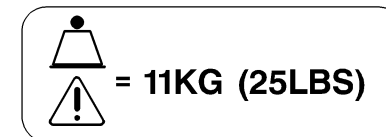
67090-03 Attached Calf Support



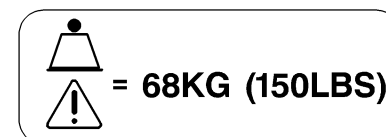
67090-09 Oxygen Tank Holder



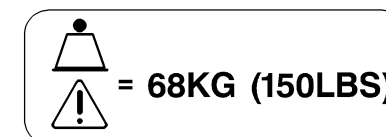
67090-04 Foley Hook Kit



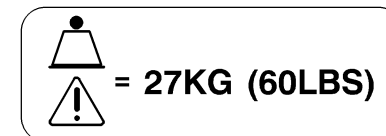
67090-10 Permanent IV Pole



67090-05 Foot Rest Bar



67090-11 Foot Supports



67090-06 Full Leg Supports

m272a008

NOTES:

Chapter 2

Troubleshooting Procedures

2

Getting Started



WARNING:

Only facility-authorized personnel should troubleshoot the bed. Troubleshooting by unauthorized personnel could result in personal injury or equipment damage.

Begin each procedure in this chapter with step 1. Follow the sequence outlined (each step assumes the previous step has been completed). In each step, the normal operation of the product can be confirmed by answering **Yes** or **No** to the statement. Your response will lead to another step in the procedure, a repair analysis procedure (RAP), or a component replacement. If more than one component is listed, replace them in the given order.

To begin gathering information about the problem, start with **Initial Actions**.

To isolate or identify a problem and to verify the repair after completing each corrective action (replacing or adjusting a part, seating a connector, etc.), perform the **Function Checks**.

To verify the repair, perform the **Final Actions** after the Function Checks.

If troubleshooting procedures do not isolate the problem, call Hill-Rom Technical Support at (800) 445-3720 for assistance.

Test Equipment

You will need a digital or analog multimeter (VOM) with fine tip probes to troubleshoot the bed.

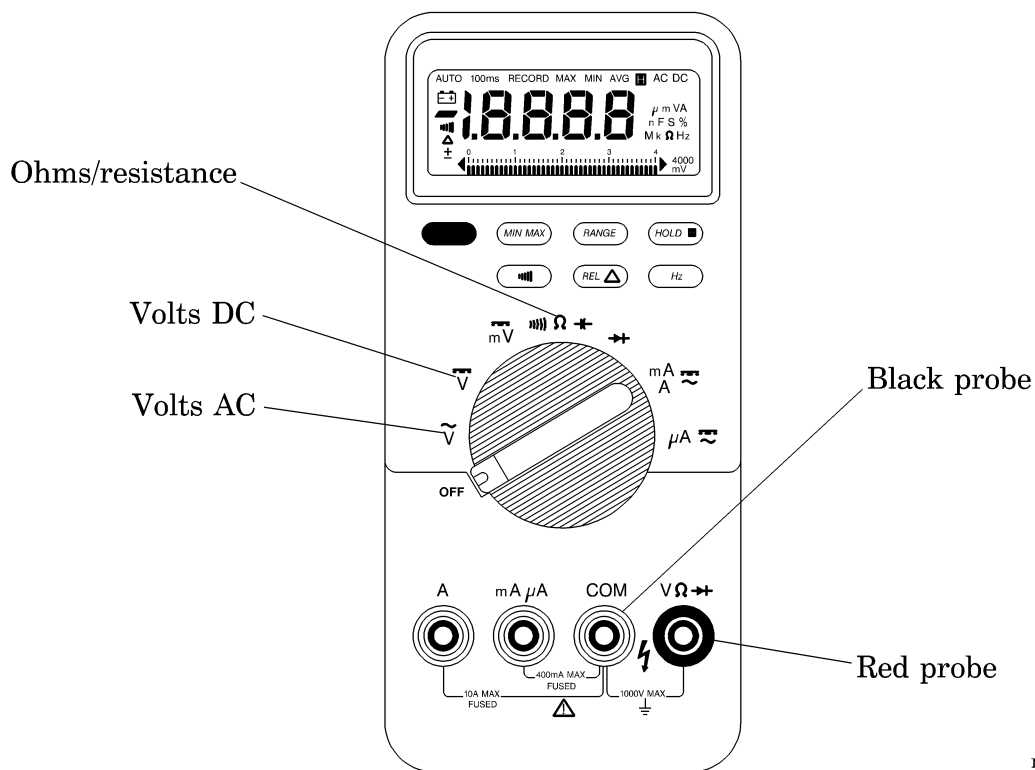


WARNING:

Refer to your VOM owner’s manual for complete and detailed information regarding the operation of your VOM. Failure to do so could result in personal injury or equipment damage.

Figure 2-1 on page 2-2 represents a common digital VOM. The three basic electrical functions that you will test are alternating current (AC), direct current (DC), and ohms/resistance.

Figure 2-1. VOM



m272_057

Figure 2-1 on page 2-2 displays the correct connection for the fine tip probes. The red probe plugs into the port marked “V Ω.” The black probe plugs into the port marked “COM.” The troubleshooting repair analysis procedure (RAP) indicates where on the bed to connect the red probe and black probe.

**WARNING:**

Unplug the bed from its power source and disconnect the battery back-up before checking ohms/resistance measurements. Failure to disconnect line voltage to the bed can damage the VOM and cause equipment damage or personal injury.

2

Initial Actions

To gather information from operators concerning problems with the bed, use Initial Actions. Note symptoms or other information concerning the problem that the operator describes. This information helps identify the probable cause.

1. Someone who can explain the problem is available.

Yes **No**

↓ → Go to “Function Checks” on page 2-4.

2. Ask that person to demonstrate or explain the problem. The problem can be duplicated.

Yes **No**

↓ → Go to “Function Checks” on page 2-4.

3. The problem is a result of improper operator action.

Yes **No**

↓ → Go to “Function Checks” on page 2-4.

4. Instruct the operator to refer to the procedures in the *Affinity® Three Birthing Bed and Affinity® Four Birthing Bed User Manual (USR025)*. Do the “Function Checks” on page 2-4.

Quick Reference Problem/Solution Matrix

If a problem with the bed system is readily identified, use table 2-1 on page 2-4 to quickly go to the applicable troubleshooting procedure. If the problem is not readily identified, go to “Function Checks” on page 2-4.

Table 2-1. Quick Reference Problem/Solution Matrix

Problem	Solution
Hilow Drive Operation Failures	RAP 2.1
Hilow Up Malfunction	RAP 2.2
Hilow Down Malfunction	RAP 2.3
Head Drive Operation Failures	RAP 2.4
Head Up Malfunction	RAP 2.5
Head Down Malfunction	RAP 2.6
Foot Drive Operation Failures	RAP 2.7
Foot Up Malfunction	RAP 2.8
Foot Down Malfunction	RAP 2.9
Hilow Up Malfunction (When The Foot Section Is Lowered)	RAP 2.10
Brake Caster Malfunction	RAP 2.11
Bed Air Surface Malfunction	RAP 2.12
Night Light Does Not Illuminate	RAP 2.13
Siderail Mechanism Does Not Hold	RAP 2.14
Trend-Like Position Malfunction	RAP 2.15
Battery Backup Malfunction	RAP 2.16
CPR Release Malfunction	RAP 2.17

Function Checks

Function checks determine whether the bed is operating properly. All caregiver control panel functions are available from both the right and left siderails. When checking redundant function controls, activate each of the siderails to determine if the fault is contained in one or both of the siderails.

1. Initial Actions have been performed.

Yes **No**

↓

→ Go to “Initial Actions” on page 2-3.

2. The bed is plugged into an appropriate power source.

Yes **No**
↓ → Plug the bed into an appropriate power source.

3. The lockout switch is in the “ON” (unlocked) position before proceeding with the function checks.

Yes **No**
↓ → Place the lockout switch in the “ON” (unlocked) position. Go to step 4.

4. Inspect the siderail cable connections to the logic control P.C. board cable. The cables are connected properly.

Yes **No**
↓ → Connect the siderail cable to the cable from the logic control P.C. board. Go to step 5.

5. Visually inspect the bed for loose connections on cable assemblies and electrical wires. All cable connections and wiring are properly secured.

Yes **No**
↓ → Secure the cable connections and wiring. Go to step 6.

6. Inspect the bed for signs of obvious damage. The bed appears to be all right.

Yes **No**
↓ → Repair the damage, and proceed to the section, “Hilow System Functional Check” on page 2-5.

Hilow System Functional Check

1. Use the bed function controls to place the bed in the following positions:

- Position the bed in the mid-height position with the hilow function.
- Raise the foot section to the high position with the foot function.
- Lower the head to the low position with the head function.
- Ensure that the bed is out of the Trend-Like position (the sleep surface is level).

2. Momentarily activate the hilow up switch. The bed rises.

Yes **No**
↓ → Go to RAP 2.2.

3. Momentarily activate the hilow down switch. The bed lowers.
Yes **No**
↓ → Go to RAP 2.3.
4. Activate the hilow up and down switch. The hilow motor is free of excessive noise or any mechanical binding/grinding.
Yes **No**
↓ → Go to RAP 2.1.
5. Raise, and then lower the sleep surface using the hilow function. The bed sleep surface stops and does not drift downward or coast.
Yes **No**
↓ → Go to RAP 2.1.
6. Raise the bed to the high position using the hilow function. Determine the hilow up limit setting by measuring at the side of the bed from the floor to the top of the mainframe (see figure 4-5 on page 4-12). The hilow limit (LBU) measurement is 31" ± ½" (79 cm ± 12.7 mm).
Yes **No**
↓ → Adjust the hilow limit switch (LBU) (refer to procedure 4.4). If this solves the problem, go to "Final Actions" on page 2-10. Otherwise, call Hill-Rom Technical Support at (800) 445-3720.
7. Lower the bed to the low position using the hilow function. The bed stops at the (LBD) limit stop. The bed height is 16" ± ½" (41 cm ± 12.7 mm).
Yes **No**
↓ → Adjust the hilow limit switch (LBD) (refer to procedure 4.4). If this solves the problem, go to "Final Actions" on page 2-10. Otherwise, call Hill-Rom Technical Support at (800) 445-3720.

Trend-Like Position Functional Check

1. Position the bed into a mid height position with the hilow function. Activate the Trend-Like position release handle at the head end of the bed, and place the bed in and out of the Trend-Like position. The bed goes in and out of Trend-Like position smoothly, and the sleep surface is secure when the handle is released:
Yes **No**
↓ → Adjust the Trend-Like position sensing switch (refer to procedure 4.9). If this solves the problem, go to "Final Actions" on page 2-10. Otherwise, call Hill-Rom Technical Support at (800) 445-3720.

Head System Functional Check

1. Ensure that the sleep surface is level, and place the bed in the following positions:
 - Place the bed in a mid-height position with the hilow function.
 - Place the head section in a mid-height position with the head function.
2. Momentarily activate the head up switch. The head section rises.
Yes **No**
↓ → Go to RAP 2.5.
3. Momentarily activate the head down switch. The head section lowers.
Yes **No**
↓ → Go to RAP 2.6.
4. Activate the head up or down switch. The head motor is free of excessive noise or any mechanical binding/grinding.
Yes **No**
↓ → Go to RAP 2.4.
5. Raise the head section to the high position with the head up switch. Note the position of the sleep surface. The head section stops and does not drift downward or coast.
Yes **No**
↓ → Go to RAP 2.4.
6. Raise the head section to the high position with the head up switch. Evenly distribute a maximum of 50 lb (23 kg) of weight on the head section of the sleep surface simulating a 50 lb (23 kg) patient. Activate the CPR function by pulling the CPR release lever located at the side of the bed. The head section lowers to a flat position within approximately 7 seconds.
Yes **No**
↓ → Adjust the CPR release cables (refer to procedure 4.8). If this solves the problem, go to “Final Actions” on page 2-10. Otherwise, call Hill-Rom Technical Support at (800) 445-3720.

Foot System Functional Check

1. Place the bed in the following positions:
 - Position the bed in the mid-height position with the hilow function.
 - Use the foot function to raise the foot section until the mattress is level with the seat section mattress.
 - Lower the head section to the low position with the head function.
 - Ensure that the bed is out of the Trend-Like position (the sleep surface is level).
2. Press the foot up switch, and activate the foot section. The foot section rises when the foot up switch is activated.

Yes **No**
↓ → Go to RAP 2.8.
3. Press the foot down switch. The foot section lowers when the foot down switch is activated.

Yes **No**
↓ → Go to RAP 2.9.
4. Raise the foot section to the high position using the foot up switch. The top of the foot section stops approximately 2-1/2" (6.35 cm) above the seat section.

Yes **No**
↓ → Adjust the foot limit switch (refer to procedure 4.7). If this solves the problem, go to "Final Actions" on page 2-10. Otherwise, call Hill-Rom Technical Support at (800) 445-3720.
5. Lower the foot section to the low position with the foot down switch. The foot drive stops when the foot lift arm is 1/4" (6.4 mm) above the foot end hilow lift arm (see figure 4-9 on page 4-21).

Yes **No**
↓ → Adjust the foot limit switch (refer to procedure 4.7). If this solves the problem, go to "Final Actions" on page 2-10. Otherwise, call Hill-Rom Technical Support at (800) 445-3720.
6. Lower the bed to the low position with the hilow down switch. Lower the foot section with the foot down switch. The bed automatically rises from the low position.

Yes **No**
↓ → Go to RAP 2.10.

7. Activate the foot up or down switch. The foot motor is free of excessive noise or any mechanical binding/grinding.

Yes **No**
↓ → Go to RAP 2.7.

Air System Functional Check

1. Press the seat inflate button, and activate the bed air surface. The seat section mattress inflates.

Yes **No**
↓ → Go to RAP 2.12.

2. Press and hold the seat deflate button, and activate the bed air surface. The seat section mattress deflates.

Yes **No**
↓ → Go to RAP 2.12.

3. Press the back inflate button, and activate the bed air surface. The lumbar section inflates.

Yes **No**
↓ → Go to RAP 2.12.

4. Press the back deflate button to activate the bed air surface. The lumbar section deflates.

Yes **No**
↓ → Go to RAP 2.12.

Other Bed Functional Checks

1. The lockout switch locks out the designated inboard/outboard controls when placed in the “OFF” position (locked), and enables the functions when placed in the “ON” position (unlocked). The lockout functions work properly.

Yes **No**
↓ → Replace the faulty rocker switch (refer to procedure 4.26). If this solves the problem, go to “Final Actions” on page 2-10. Otherwise, call Hill-Rom Technical Support at (800) 445-3720.

2. Operate all radio, TV, nurse call, and lighting functions in both siderails. All functions operate properly.
Yes **No**
↓ → Replace the P.C. switch board containing the faulty function(s) for caregiver controls (refer to procedure 4.29), or for patient controls (refer to procedure 4.28). If this solves the problem, go to “Final Actions” on page 2-10. Otherwise, call Hill-Rom Technical Support at (800) 445-3720.
3. Perform the brake/steer performance check. Place the brake steer pedal into the brake position and then the steer position. The brake and steer functions operate properly.
Yes **No**
↓ → Go to RAP 2.11, and adjust the brake and steer functions (refer to procedure 4.30). If this solves the problem, go to “Final Actions” on page 2-10. Otherwise, call Hill-Rom Technical Support at (800) 445-3720.
4. Operate the labor grips on both sides of the bed. The labor grips latch when in the full up position and then release when the release handle is activated.
Yes **No**
↓ → Replace the faulty labor grips (refer to procedure 4.15).
5. Operate the siderail latching mechanism by raising and then lowering the siderail. The siderail latches when in the full up position and lowers slowly when the release handle is activated and allowed to free fall.
Yes **No**
↓ → Replace the faulty siderail assembly (refer to procedure 4.27).
6. Unplug the bed from its power source, and verify that the battery back-up is operating properly by activating bed functions. The battery back-up provides sufficient power to operate the bed functions.
Yes **No**
↓ → Go to RAP 2.16.
7. Go to “Final Actions” on page 2-10.

Final Actions

1. Complete the required preventive maintenance procedures. See “Preventive Maintenance” on page 6-7.
2. Complete all required administrative tasks.

2.1 Hilow Drive Operation Failures

The hilow motor runs, but other problems with the motor are suspected (i.e., it is noisy, it drifts, etc.).

1. Raise and lower the bed with the hilow function. Look for evidence of physical damage to the drive system (i.e., check for a bent motor shaft, loose metal, etc.). The drive system passes inspection.

Yes **No**

↓ → Replace the hilow motor (refer to procedure 4.3). If this solves the problem, go to “Final Actions” on page 2-10. Otherwise, continue to step 2.

2. Inspect the mounting clevis pins and cotter pins on the hilow motor drive. The clevis pins are installed properly.

Yes **No**

↓ → Install the hilow motor clevis pins properly to secure the hilow motor to the bed frame. If this solves the problem, go to “Final Actions” on page 2-10. Otherwise, continue to step 3.

3. Raise and lower the bed under a load condition. The hilow drive runs quietly.

Yes **No**

↓ → Inspect for damage to the hilow motor. Replace if necessary (refer to procedure 4.3). If this solves the problem, go to “Final Actions” on page 2-10. Otherwise, continue to step 4.

4. Using the hilow function, raise and lower the bed. The hilow motor retains its position, and does not drift or coast.

Yes **No**

↓ → Replace the hilow motor (refer to procedure 4.3). If this solves the problem, go to “Final Actions” on page 2-10. Otherwise, call Hill-Rom Technical Support at (800) 445-3720.

5. Go to “Final Actions” on page 2-10.

2.2 Hilow Up Malfunction

The hilow motor does not raise the bed when the hilow up switch is activated.

1. The bed is plugged into the appropriate power source, and the lockout switch is **off**.

Yes **No**

↓ → Plug the bed into an appropriate power source and turn the lockout switch off. If this solves the problem, go to “Final Actions” on page 2-10. Otherwise, continue to step 2.

2. Activate the hilow up switch on the opposite siderail. The hilow motor runs.

Yes **No**

↓ → Go to step 4.

3. Activate another bed function switch on the siderail with the non-functioning hilow up switch. The other bed functions work properly.

Yes **No**

↓ → Replace the P.C. switch board containing the faulty function(s) for caregiver controls (refer to procedure 4.30) or for patient controls (refer to procedure 4.29). If this solves the problem, go to “Final Actions” on page 2-10. Otherwise, continue to step 4.

4. Activate the hilow up switch, and listen for an audible relay click. An audible clicking sound can be heard.

Yes **No**

↓ → Replace the logic control P.C. board (refer to procedure 4.23). If this solves the problem, go to “Final Actions” on page 2-10. Otherwise, continue to step 5.

5. Allow the hilow motor to cool. Activate the hilow motor up switch. The hilow motor runs.

Yes **No**

↓ → Replace the hilow motor (refer to procedure 4.3). If this solves the problem, go to “Final Actions” on page 2-10. Otherwise, continue to step 7.

6. Go to “Final Actions” on page 2-10.

7. Set your VOM to measure V DC. At the logic control P.C. board connector P15, place your black probe into pin 1 (black wire) and your red probe into pin 2 (blue wire). Press the hilow up switch. The voltage is between 25V DC and 30V DC.

Yes **No**

- ↓ → Replace the logic control P.C. board (refer to procedure 4.23).
If this solves the problem, go to “Final Actions” on page 2-10.
Otherwise, continue to step 8.

8. Replace the hilow motor (refer to procedure 4.3).

This solves the problem.

Yes **No**

- ↓ → Call Hill-Rom Technical Support at (800) 445-3720.

9. Go to “Final Actions” on page 2-10.

2.3 Hilow Down Malfunction

The hilow motor does not lower the bed when the hilow down switch is activated.

1. The bed is plugged into the appropriate power source, and the lockout switch is **off**.

Yes **No**

↓

→ Plug the bed into an appropriate power source and turn the lockout switch off. If this solves the problem, go to “Final Actions” on page 2-10. Otherwise, continue to step 2.

2. Activate the hilow down switch on the opposite siderail. The hilow motor runs.

Yes **No**

↓

→ Go to step 4.

3. Activate another bed function switch on the siderail with the non-functioning hilow down switch. The other bed functions work properly.

Yes **No**

↓

→ Replace the P.C. switch board containing the faulty function(s) for caregiver controls (refer to procedure 4.30) or for patient controls (refer to procedure 4.29). If this solves the problem, go to “Final Actions” on page 2-10. Otherwise, continue to step 4.

4. Activate the hilow down switch, and listen for an audible relay click. An audible clicking sound can be heard.

Yes **No**

↓

→ Replace the logic control P.C. board (refer to procedure 4.23). If this solves the problem, go to “Final Actions” on page 2-10. Otherwise, continue to step 5.

5. Allow the hilow motor to cool. Activate the hilow motor down switch. The hilow motor runs.

Yes **No**

↓

→ Replace the hilow motor (refer to procedure 4.3). If this solves the problem, go to “Final Actions” on page 2-10. Otherwise, continue to step 7.

6. Go to “Final Actions” on page 2-10.

7. Set your VOM to measure V DC. At the logic control P.C. board connector P15, place your black probe into pin 1 (black wire) and your red probe into pin 2 (blue wire). Press the hilow down switch. The voltage is between 25V DC and 30V DC.

Yes **No**

↓

→ Replace the logic control P.C. board (refer to procedure 4.23).
If this solves the problem, go to “Final Actions” on page 2-10.
Otherwise, continue to step 8.

8. Replace the hilow motor (refer to procedure 4.3).

This solves the problem.

Yes **No**

↓

→ Call Hill-Rom Technical Support at (800) 445-3720.

9. Go to “Final Actions” on page 2-10.

2.4 Head Drive Operation Failures

The hilow motor runs, but other problems with the motor are suspected (i.e., it is noisy, it drifts, etc.).

1. Raise and lower the head section with the head function. Look for evidence of physical damage to the drive system (i.e., check for a bent motor shaft, loose metal, etc.). The drive system passes inspection.

Yes **No**

↓

→ Replace the head motor (refer to procedure 4.5). If this solves the problem, go to “Final Actions” on page 2-10. Otherwise, continue to step 2.

2. Inspect the mounting clevis pins and cotter pins on the head motor drive. The clevis pins are installed properly.

Yes **No**

↓

→ Install the head motor clevis pins properly to secure the head motor to the bed frame. If this solves the problem, go to “Final Actions” on page 2-10. Otherwise, continue to step 3.

3. Raise and lower the head section under a load condition. The head drive runs quietly.

Yes **No**

↓

→ Inspect for damage to the head motor. Replace if necessary (refer to procedure 4.5). If this solves the problem, go to “Final Actions” on page 2-10. Otherwise, continue to step 4.

4. Using the head function, raise and lower the head section. The head motor retains its position, and does not drift or coast.

Yes **No**

↓

→ Replace the head motor (refer to procedure 4.5). If this solves the problem, go to “Final Actions” on page 2-10. Otherwise, call Hill-Rom Technical Support at (800) 445-3720.

5. Go to “Final Actions” on page 2-10.

2.5 Head Up Malfunction

The head motor does not raise the head section when the head up switch is activated.

1. The bed is plugged into the appropriate power source, and the lockout switch is **off**.

Yes	No
↓	→ Plug the bed into an appropriate power source and turn the lockout switch off. If this solves the problem, go to “Final Actions” on page 2-10. Otherwise, continue to step 2.

2. Check the CPR release handles on either side of the bed. The CPR handles are in the proper position, and no sheets or blankets are caught between the head section and the CPR release handle causing the CPR release to actuate.

Yes	No
↓	→ Remove the sheet or blanket that is causing the CPR release to actuate. If this solves the problem, go to “Final Actions” on page 2-10. Otherwise, continue to step 3.

3. Activate the head up switch on the opposite siderail. The head motor runs.

Yes	No
↓	→ Go to step 5.

4. Activate another bed switch on the siderail with the non-functioning head up switch. The other bed functions work properly.

Yes	No
↓	→ Replace the P.C. switch board containing the faulty function(s) for caregiver controls (refer to procedure 4.30) or for patient controls (refer to procedure 4.29). If this solves the problem, go to “Final Actions” on page 2-10. Otherwise, continue to step 5.

5. Activate the head up switch, and listen for an audible relay click. An audible clicking sound can be heard.

Yes	No
↓	→ Replace the logic control P.C. board (refer to procedure 4.23). If this solves the problem, go to “Final Actions” on page 2-10. Otherwise, continue to step 6.

6. Allow the head motor to cool. Activate the head motor up switch. The head motor runs.

Yes **No**

↓

→ Replace the head motor (refer to procedure 4.5). If this solves the problem, go to “Final Actions” on page 2-10. Otherwise, continue to step 8.

7. Go to “Final Actions” on page 2-10.

8. Set your VOM to measure V DC. At the logic control P.C. board connector P4, place your black probe into pin 1 (brown wire) and your red probe into pin 2 (blue wire). Press the head up switch. The voltage is between 25V DC and 30V DC.

Yes **No**

↓

→ Replace the logic control P.C. board (refer to procedure 4.23). If this solves the problem, go to “Final Actions” on page 2-10. Otherwise, continue to step 9.

9. Replace the head motor (refer to procedure 4.5).

This solves the problem.

Yes **No**

↓

→ Call Hill-Rom Technical Support at (800) 445-3720.

10. Go to “Final Actions” on page 2-10.

2.6 Head Down Malfunction

The head motor does not lower the head section when the head down switch is activated.

1. The bed is plugged into the appropriate power source, and the lockout switch is **off**.

Yes	No
↓	→ Plug the bed into an appropriate power source and turn the lockout switch off. If this solves the problem, go to “Final Actions” on page 2-10. Otherwise, continue to step 2.

2. Activate the head down switch on the opposite siderail. The head motor runs.

Yes	No
↓	→ Go to step 4.

3. Activate another bed switch on the siderail with the non-functioning head down switch. The other bed functions work properly.

Yes	No
↓	→ Replace the P.C. switch board containing the faulty function(s) for caregiver controls (refer to procedure 4.30) or for patient controls (refer to procedure 4.29). If this solves the problem, go to “Final Actions” on page 2-10. Otherwise, continue to step 4.

4. Activate the head down switch, and listen for an audible relay click. An audible clicking sound can be heard.

Yes	No
↓	→ Replace the logic control P.C. board (refer to procedure 4.23). If this solves the problem, go to “Final Actions” on page 2-10. Otherwise, continue to step 5.

5. Allow the head motor to cool. Activate the head down switch. The head motor runs.

Yes	No
↓	→ Replace the head motor (refer to procedure 4.5). If this solves the problem, go to “Final Actions” on page 2-10. Otherwise, continue to step 7.

6. Go to “Final Actions” on page 2-10.

7. Set your VOM to measure V DC. At the logic control P.C. board connector P4, place your black probe into pin 1 (brown wire) and your red probe into pin 2 (blue wire). Press the head down switch. The voltage is between 25V DC and 30V DC.

Yes **No**

- ↓ → Replace the logic control P.C. board (refer to procedure 4.23).
If this solves the problem, go to “Final Actions” on page 2-10.
Otherwise, continue to step 8.

8. Replace the head motor (refer to procedure 4.5).

This solves the problem.

Yes **No**

- ↓ → Call Hill-Rom Technical Support at (800) 445-3720.

9. Go to “Final Actions” on page 2-10.

2.7 Foot Drive Operation Failures

The foot motor runs, but other problems with the motor are suspected (i.e., it is noisy, it drifts, etc.).

1. Raise and lower the foot section with the foot function. Look for evidence of physical damage to the drive system (i.e., check for a bent motor shaft, loose metal, etc.). The drive system passes inspection.

Yes **No**

↓ → Replace the foot motor (refer to procedure 4.6). If this solves the problem, go to “Final Actions” on page 2-10. Otherwise, continue to step 2.

2. Inspect the mounting clevis pins and cotter pins on the foot motor drive. The clevis pins are installed properly.

Yes **No**

↓ → Install the foot motor clevis pins properly to secure the foot motor to the bed frame. If this solves the problem, go to “Final Actions” on page 2-10. Otherwise, continue to step 3.

3. Raise and lower the foot section under a load condition. The foot drive runs quietly.

Yes **No**

↓ → Inspect for damage to the foot motor. Replace if necessary (refer to procedure 4.6). If this solves the problem, go to “Final Actions” on page 2-10. Otherwise, continue to step 4.

4. Using the foot function, raise the foot section up and down. The foot motor retains its position, and does not drift or coast.

Yes **No**

↓ → Replace the foot motor (refer to procedure 4.6). If this solves the problem, go to “Final Actions” on page 2-10. Otherwise, call Hill-Rom Technical Support at (800) 445-3720.

5. Go to “Final Actions” on page 2-10.

2.8 Foot Up Malfunction

The foot motor does not raise the foot section when the foot up switch is activated.

1. The bed is plugged into the appropriate power source, and the lockout switch is **off**.

Yes **No**

↓

→ Plug the bed into an appropriate power source and turn the lockout switch off. If this solves the problem, go to “Final Actions” on page 2-10. Otherwise, continue to step 2.

2. Activate the foot up switch on the opposite siderail. The foot motor runs.

Yes **No**

↓

→ Go to step 4.

3. Activate another bed switch on the siderail with the non-functioning foot up switch. The other bed functions work properly.

Yes **No**

↓

→ Replace the P.C. switch board containing the faulty function(s) for caregiver controls (refer to procedure 4.30) or for patient controls (refer to procedure 4.29). If this solves the problem, go to “Final Actions” on page 2-10. Otherwise, continue to step 4.

4. Activate the foot up switch, and listen for an audible relay click. An audible clicking sound can be heard.

Yes **No**

↓

→ Replace the logic control P.C. board (refer to procedure 4.23). If this solves the problem, go to “Final Actions” on page 2-10. Otherwise, continue to step 5.

5. Allow the foot motor to cool. Activate the foot up switch. The foot motor runs.

Yes **No**

↓

→ Replace the foot motor (refer to procedure 4.6). If this solves the problem, go to “Final Actions” on page 2-10. Otherwise, continue to step 7.

6. Go to “Final Actions” on page 2-10.

7. Set your VOM to measure V DC. At the logic control P.C. board connector P6, place your black probe into pin 1 (black wire) and your red probe into pin 2 (blue wire). Press the foot up switch. The voltage is between 25V DC and 30V DC.

Yes **No**

- ↓ → Replace the logic control P.C. board (refer to procedure 4.23).
If this solves the problem, go to “Final Actions” on page 2-10.
Otherwise, continue to step 8.

8. Replace the foot motor (refer to procedure 4.6).

This solves the problem.

Yes **No**

- ↓ → Call Hill-Rom Technical Support at (800) 445-3720.

9. Go to “Final Actions” on page 2-10.