

Temperature Control Panel Wiring Diagram

Model: ISPA-120-IP-15A

Shift Controls, Inc.

Installed Options:

- TC Jack Panel Connector
- Interlock Relay, RLY-1
- 15A Power Cord

www.shift-controls.com
support@shift-controls.com
720.532.1776

Temperature Control Panel Specifications

Model Number	ISPA-120-IP-15A
Rated Voltage	120 VAC
Phases	Single
Power Controller	Zero Crossing SSR
Rated Frequency	60 Hz
SCCR	100 kA
Control Voltage	120 VAC
Maximum Fuse Size	20 Amps, Class CC, High Speed
Maximum Full Load Current	15 Amps, Resistive
Maximum Load	1800 W
Enclosure Type	Nema 4X
Operating Environment	0 - 35 deg C, 10-85% RH, Non-Condensing, Indoor Use Only

REV.	DATE	DRAWN BY	DESCRIPTION
A	03/14/16	B. KETTLER	FOR CONSTRUCTION

DRAWING TYPE: WIRING SCHEMATIC

DRAWING DESCRIPTION: CONTROL PANEL SPECIFICATIONS AND WIRE COLOR STANDARDS

DRAWING NUMBER: E-ISPA-120-IP-15A
SHEET NUMBER: SHEET i



Fuse Replacement Voltage, Amperage, Class and Type Reference

FUSE REPLACEMENT NOTES:

1) Fuses are to be replaced with fuses of the same voltage rating, current rating, and fuse type.

Fuse Name	Description	Voltage Rating	Maximum Value	Fuse Type		Manufacturer Equivalent		
						Edison	Bussmann	Littelfuse
F1, F2	Main Power Branch Fusing	600	20 Amps	Class CC	Fast-Acting	HCLR	KTK-R	KLKR
F3	Control Circuit Supply Fusing	250	1 Amp	5x20mm	Fast-Acting	GMA	GMA	235

Main Branch Fuse Protection (F1) Ampacity Reference Table

FUSE SIZING NOTES:

1) The maximum resistive heater load is 15 Amps / 1800 Watts at 120 VAC 1-Phase.

2) Fuses are to be sized 125-160% of the heater full load.

Heater Full Load Rating		3A	3.5A	4A	5A	6A	8A	10A	12A	15A	17.5A	20A
		Full Load Power, Watts	Minimum	225	263	300	375	450	600	750	900	1125
Full Load Power, Watts	Maximum	288	336	384	480	576	768	960	1152	1440	1680	1800
Full Load Current, Amps	Minimum	1.88	2.19	2.50	3.13	3.75	5.00	6.25	7.50	9.38	10.94	12.5
Full Load Current, Amps	Maximum	2.40	2.80	3.20	4.00	4.80	6.40	8.00	9.60	12.0	14.0	15

REV.	DATE	DRAWN BY	DESCRIPTION
A	03/14/16	B. KETTLER	FOR CONSTRUCTION
DRAWING TYPE WIRING SCHEMATIC			

DRAWING DESCRIPTION FUSE AND FIELD WIRING SPECIFICATIONS
--

DRAWING NUMBER E-SPA-120-IP-15A
SHEET NUMBER SHEET ii



Standard Wire Colors	
120VAC, 1-Phase Power	Black (BK)
Neutral / Grounded AC	White (WH)
Ground Wires	Green (GN)
AC Control Power, 120VAC Ungrounded AC	Black (BK)
Thermocouple Cable	Type K - Yellow Cable, Type J - Black Cable
DC Signal wires	2-Conductor Cable
RS-485, Data	2-Conductor Cable

Customer Supplied Wire Size, Rating and Terminal Tightening Torque Reference

NOTES:

1) Conductor Sizing to be Determined by NEC and Local Codes

2) Control wiring (Terminals 93-98) to be Class II unless customer supplied circuits to Alarm I (Terminals 91, 92) are greater than 150 Volts. If customer supplied wiring is greater than 150 Volts, then all control wiring (Terminals 91-98) are to be Class I.

Terminal Number	Description	Wire					Tightening Torque	
		Conductor Material	Minimum Voltage Rating	Minimum Temp. Rating	Minimum Wire Size	Maximum Wire Size	Minimum	Maximum
91, 92	User Programable Alarm (Dry Contacts)	Copper	Class I	60 C	26AWG, 0.4mm See Note 1	10AWG, 2.5mm See Note 1	5.3 in"lb, 0.6 N*m	7.0 in"lb, 0.8 N*m
93, 94	Temp. Retransmit (4-20mA Sourcing)	Copper	Class II See Note 2	60 C	26AWG, 0.4mm See Note 1	10AWG, 2.5mm See Note 1	5.3 in"lb, 0.6 N*m	7.0 in"lb, 0.8 N*m
95, 96	RS-485 Modbus Communication	Copper	Class II See Note 2	60 C	26AWG, 0.4mm See Note 1	10AWG, 2.5mm See Note 1	5.3 in"lb, 0.6 N*m	7.0 in"lb, 0.8 N*m
97, 98	Thermocouple Input	TC Wire	Class II See Note 2	60 C	24AWG	14AWG Solid 16AWG Stranded	3.5 in"lb, 0.4 N*m	3.5 in"lb, 0.4 N*m
A1, A2	External Interlock (Option)	Copper	Class I	60 C	26AWG, 0.4mm See Note 1	14AWG, 1.6mm See Note 1	3.5 in"lb, 0.4 N*m	3.5 in"lb, 0.4 N*m

REV.	DATE	DRAWN BY	DESCRIPTION
A	03/14/16	B. KETTLER	FOR CONSTRUCTION
DRAWING TYPE			
WIRING SCHEMATIC			

DRAWING DESCRIPTION
FUSE AND FIELD WIRING SPECIFICATIONS

DRAWING NUMBER
E-ISPA-120-IP-15A
SHEET NUMBER
SHEET iii



Wiring Schematic Typical Symbols and Standards

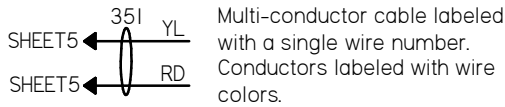
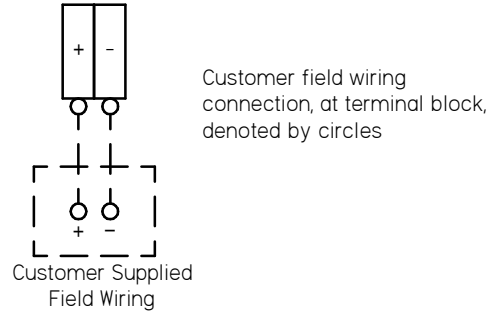
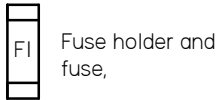
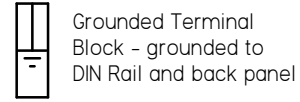
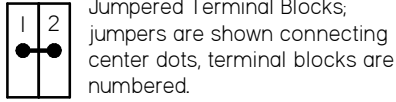

--- Customer supplied, field wiring

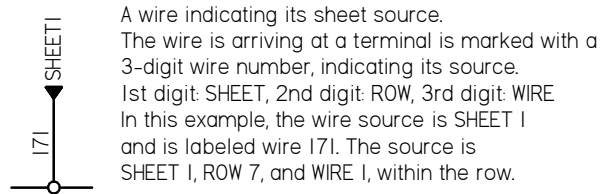
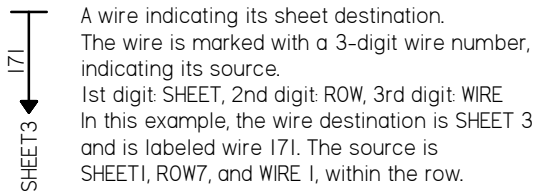
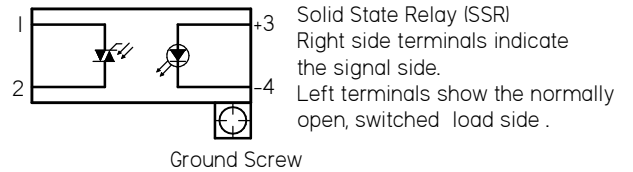
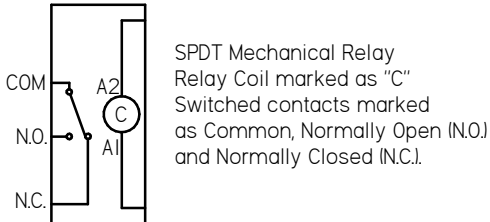
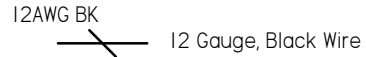

170

REV.	DATE	DRAWN BY	DESCRIPTION
A	03/14/16	B. KETTLER	FOR CONSTRUCTION
DRAWING TYPE WIRING SCHEMATIC			

DRAWING DESCRIPTION
TYPICAL SYMBOLS, STANDARDS and WIRE LABELING CONVENTIONS

DRAWING NUMBER
E-SPA-120-IP-15A
SHEET NUMBER
SHEET iv



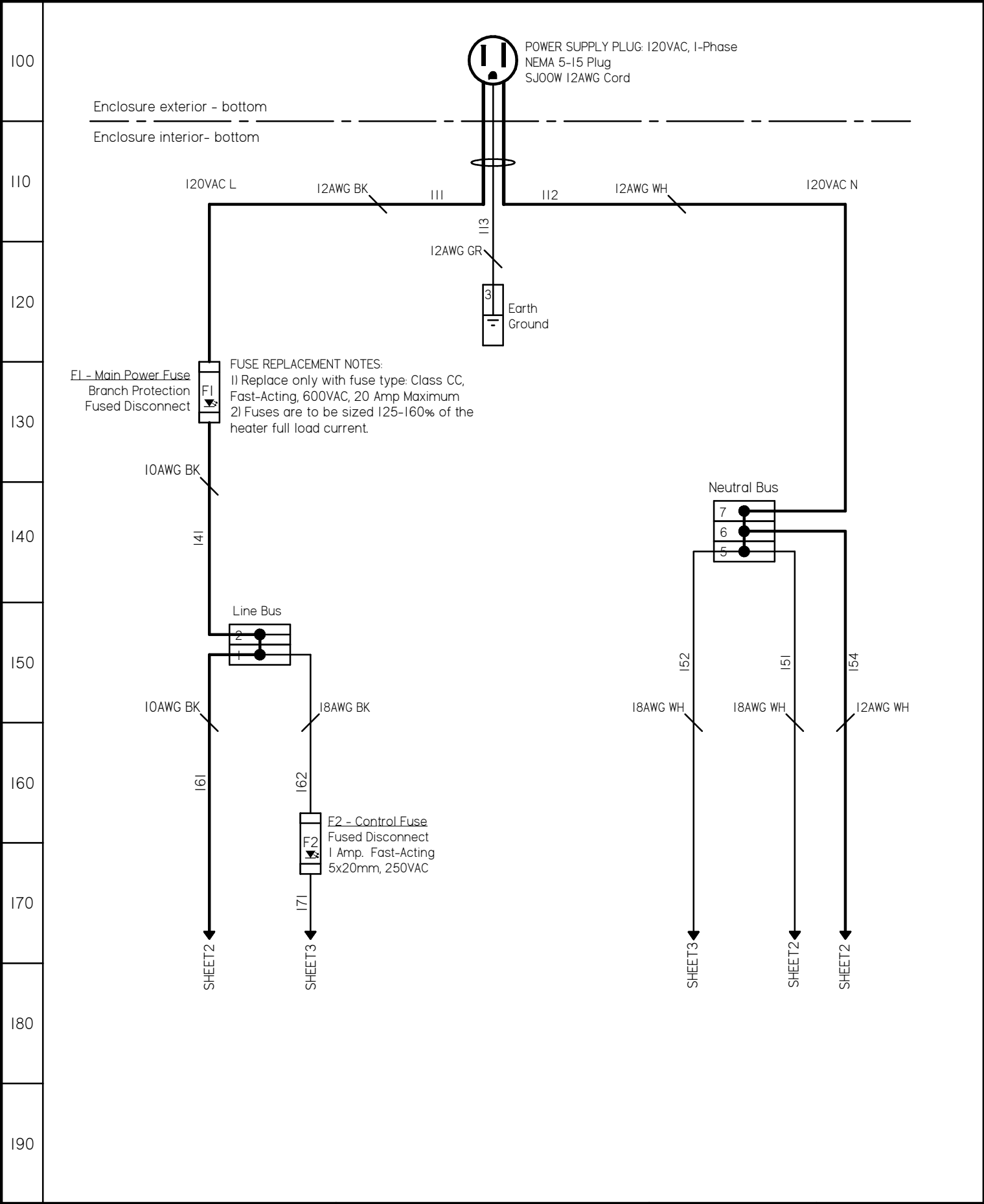

REV.	DATE	DRAWN BY	DESCRIPTION
A	03/14/16	B. KETTLER	FOR CONSTRUCTION

DRAWING TYPE

WIRING SCHEMATIC

DRAWING DESCRIPTION

FUSED DISCONNECT, CONTACTOR,
AND CONTROL TRANSFORMER

DRAWING NUMBER

E-ISPA-120-IP-15A

SHEET NUMBER

SHEET 1 of 4



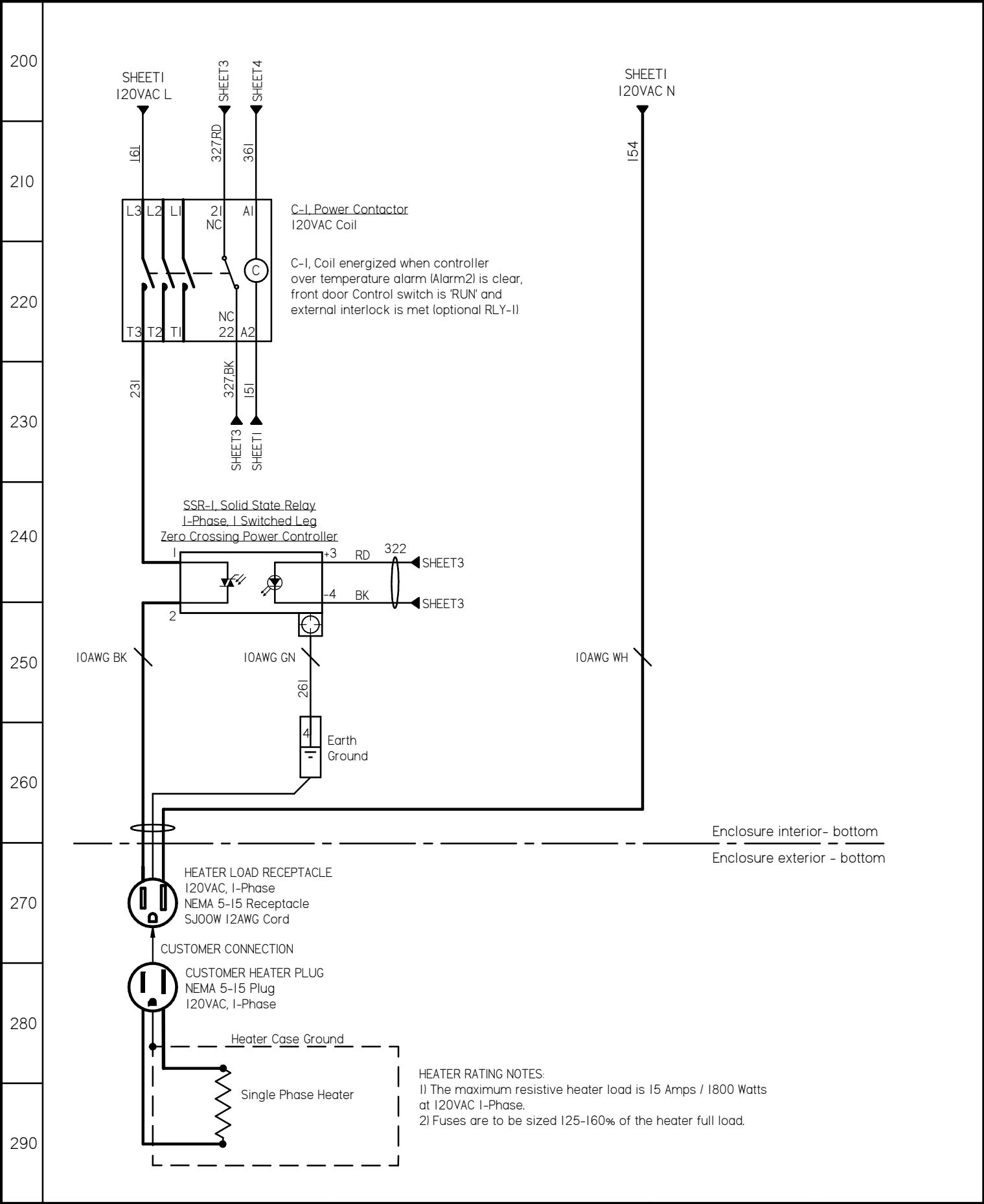

REV.	DATE	DRAWN BY	DESCRIPTION
A	03/14/16	B. KETTLER	FOR CONSTRUCTION

DRAWING TYPE: WIRING SCHEMATIC

DRAWING DESCRIPTION: POWER CONTROLLER AND ENCLOSURE COOLING

DRAWING NUMBER: E-IPSA-120-IP-15A
 SHEET NUMBER: SHEET 2 OF 4



HEATER RATING NOTES:
 1) The maximum resistive heater load is 15 Amps / 1800 Watts at 120VAC 1-Phase.
 2) Fuses are to be sized 125-160% of the heater full load.

TIC-I, PID Temperature Controller
Door Mount

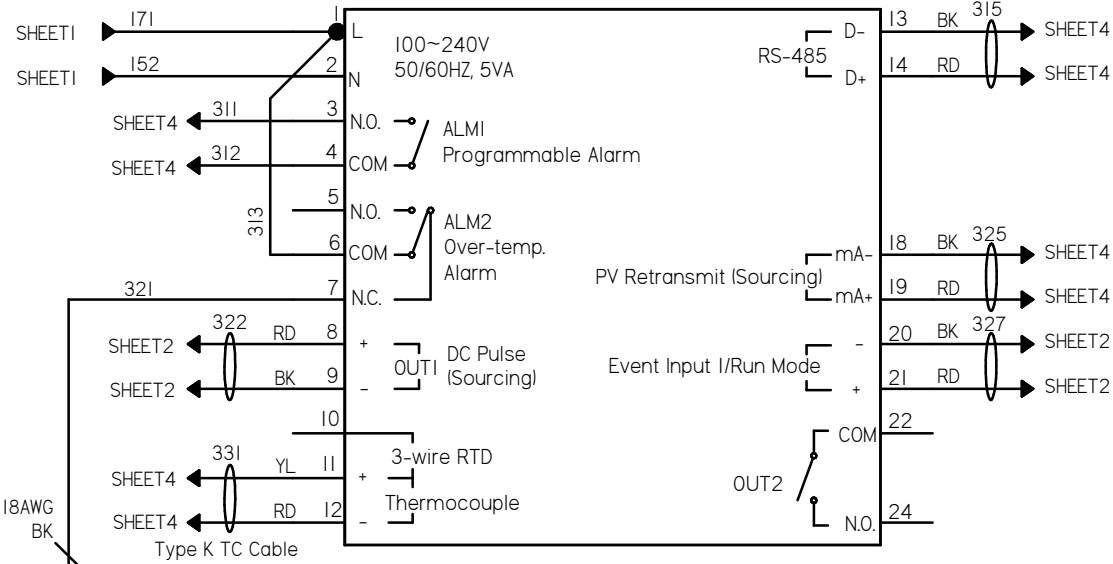

Note:
 Type K thermocouple: YL is + and RD is -
 Type J thermocouple: WH is + and RD is -

COM COM
 N.O. N.O. SW-I, SAFE / RUN Switch
 DPST, Door Mount

SHEET4
360

300
310
320
330
340
350
360
370
380
390

REV.	DATE	DRAWN BY	DESCRIPTION
A	03/14/16	B. KETTLER	FOR CONSTRUCTION

DRAWING TYPE **WIRING SCHEMATIC**

DRAWING DESCRIPTION	TEMPERATURE CONTROLLER
---------------------	-------------------------------

DRAWING NUMBER	E-SPA-120-IP-15A
SHEET NUMBER	SHEET 3 OF 4



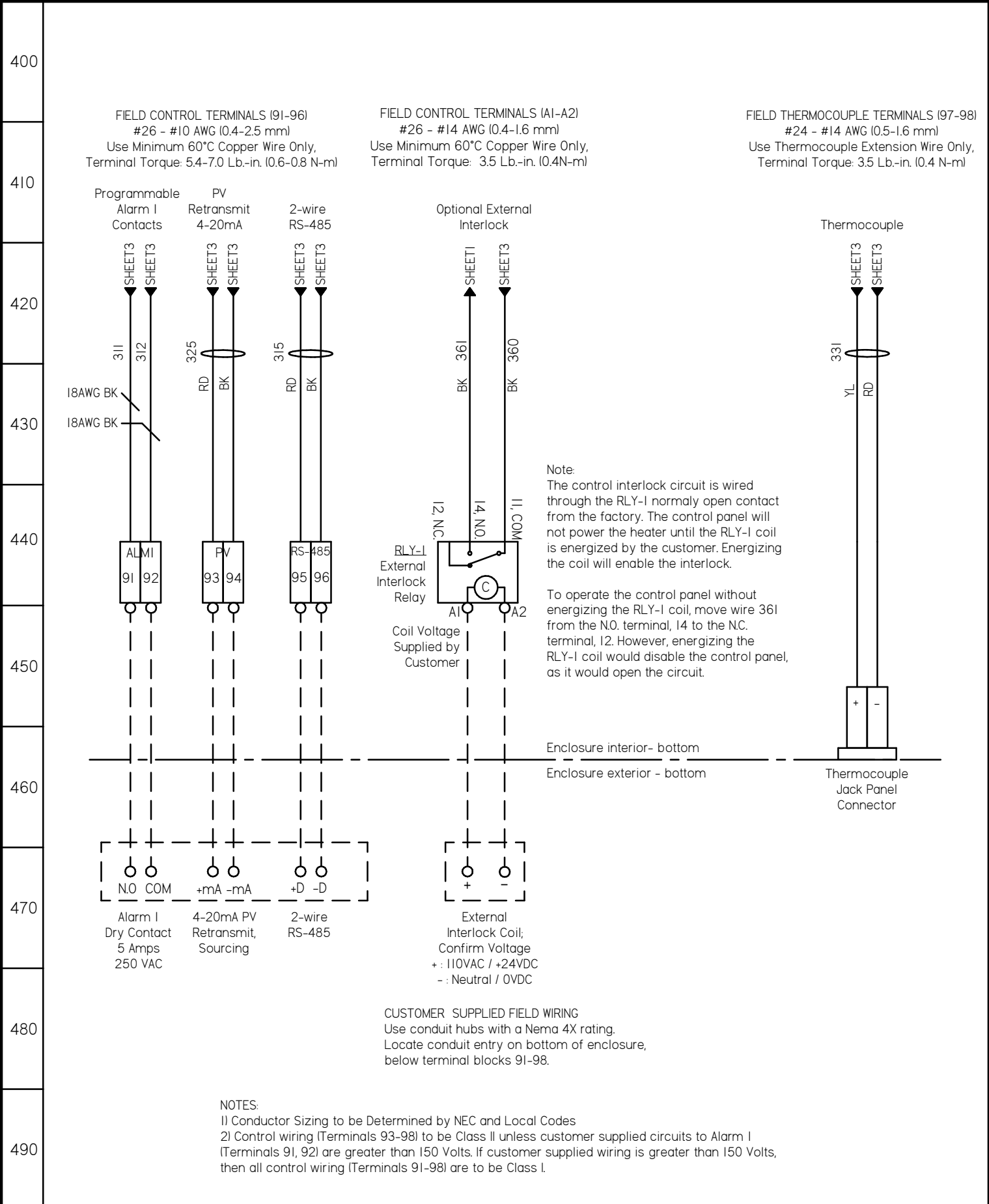

CUSTOMER SUPPLIED FIELD WIRING
 Use conduit hubs with a Nema 4X rating.
 Locate conduit entry on bottom of enclosure,
 below terminal blocks 91-98.

- NOTES:
 1) Conductor Sizing to be Determined by NEC and Local Codes
 2) Control wiring (Terminals 93-98) to be Class II unless customer supplied circuits to Alarm I (Terminals 91, 92) are greater than 150 Volts. If customer supplied wiring is greater than 150 Volts, then all control wiring (Terminals 91-98) are to be Class I.