



WP Series-1

Product Characteristic:

Base and cover: Die-casting aluminium door frame rigidly secure the glass fixed and attached to the housing with stainless steel screws, the precisely designed rotating shaft for quick maintenance security G1/2" cable gland on the housing for conduit and easy installation of button photocell.

The heat proof silicon gasket positively seal around the whole housing and whole glass ensuring high performance of protection against moisture and contaminant.

With the high specular anodized aluminium reflector and refracted through the borosilicate prismatic glass provides soft light and uniform distribution

Lumen: 3690LM / 4050LM/
4920 LM /5400LM

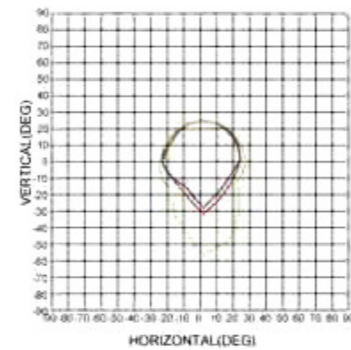
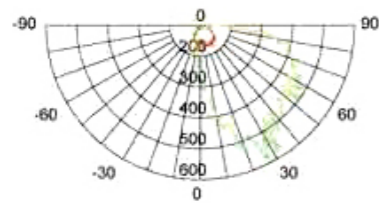
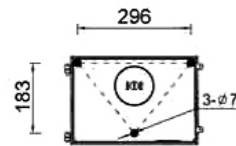
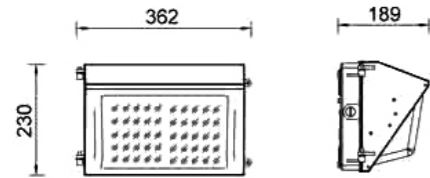

Model	Power	Input Voltage	Color Temperature	Replacement of HID	Light Efficiency
WLS-45-YS160	45W	AC90V~277V	4000 / 5000 / 6000K	100W-150W	100LM/W
WLS-60-YS160	60W				



WP Series-2

Product Characteristic:

Base and cover: Die-casting aluminium door frame rigidly secure the glass fixed and attached to the housing with stainless steel screws, the precisely designed rotating shaft for quick maintenance security G1/2" cable gland on the housing for conduit and easy installation of button photocell.

The heat proof silicon gasket positively seal around the whole housing and whole glass ensuring high performance of protection against moisture and contaminant.

With the high specular anodized aluminium reflector and refracted through the borosilicate prismatic glass provides soft light and uniform distribution

Lumen: 2870LM / 3150LM

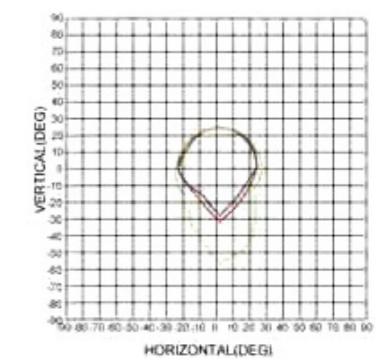
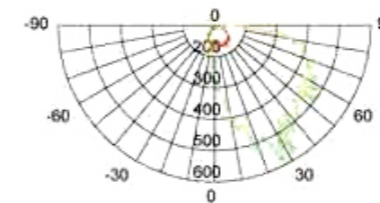
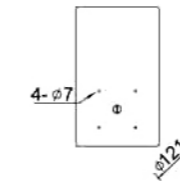
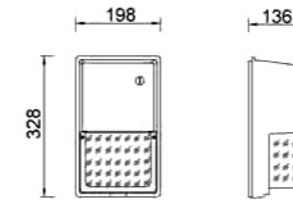

Model	Power	Input Voltage	Color Temperature	Replacement of HID	Light Efficiency
WLS-35-YS161	35W	AC90V~277V	4000 / 5000 / 6000K	70W	100LM/W





WP Series-3

Product Characteristic:

- Housing: Die-casting aluminium
- Glass: Unique non-glare tempered safety glass enclosure
- Sealing gasket: Silicon gasket
- Multiple Sizes available
- Lumen: 4200LM / 5000LM / 4920 LM / 5400LM

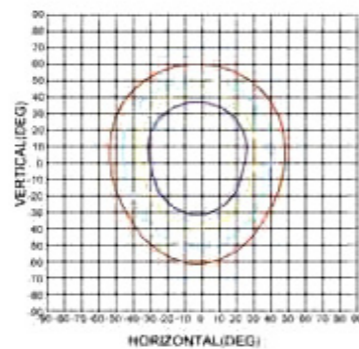
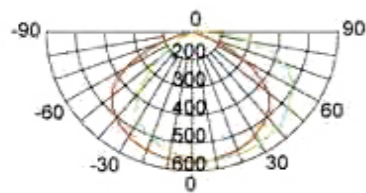
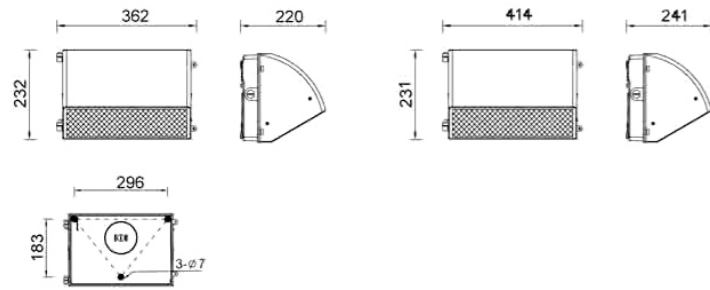

Model	Power	Input Voltage	Color Temperature	Replacement of HID	Light Efficiency
WLS-45-YS165A	45W	AC90V~277V	4000 / 5000 / 6000K	100W-150W	100LM/W
WLS-60-YS165B	60W				



WP Series-4

Product Characteristic:

- Housing: Die-casting aluminium
- Glass: Unique non-glare tempered safety glass enclosure
- Sealing gasket: Silicon gasket
- Multiple Sizes available
- Lumen: 2870LM / 3150LM / 4200LM / 5000LM / 4920 LM / 5400LM

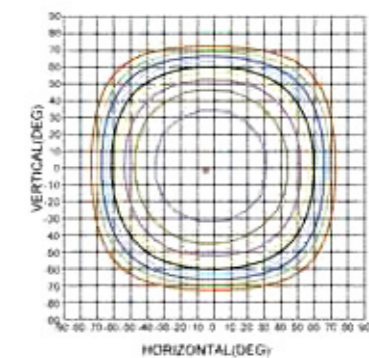
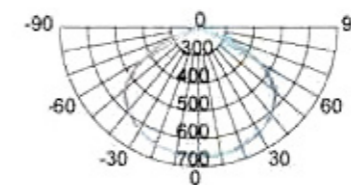
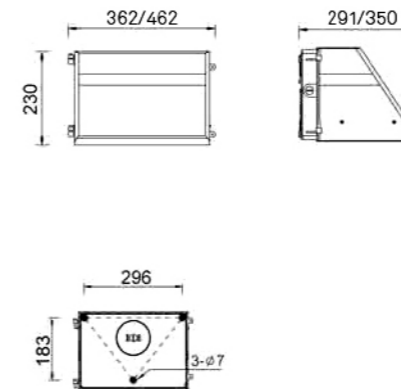

Model	Power	Input Voltage	Color Temperature	Replacement of HID	Light Efficiency
WLS-35-YS166A	35W	AC100V~240V	4000 / 5000 / 6000K	70W / 100W / 150W	90LM / W
WLS-45-YS166B	45W				
WLS-60-YS166B	60W				

