

# DOWN LIGHT



## JLS Series-1



### Technical Specification

- Cyclone type aluminium die-cast heat sink.
- Die-cast aluminium trim.
- High transmit Acrylic diffuser with no glare.
- SMD LED power: 6W, 9W, 15W, 20W, 24W
- Color Temp. (options): 3000K - 5000K
- CRI:  $\geq 80$

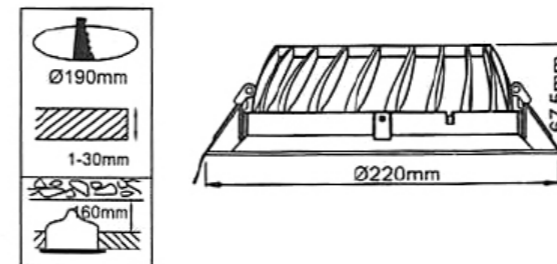

The light intensity distribution curve of polar coordinate

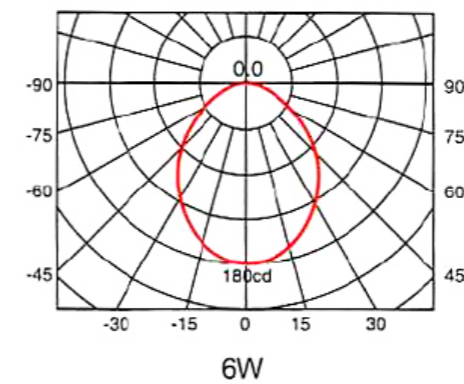

The light intensity distribution curve of polar coordinate

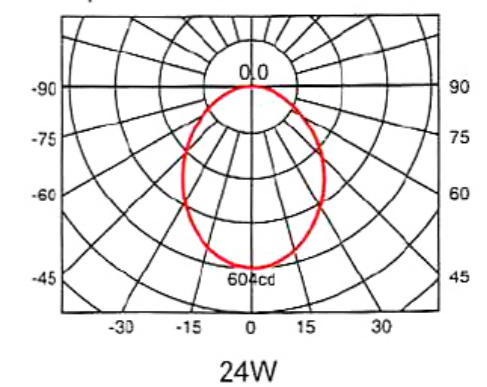

Model	Wattage	Beam Angle	Lumen	Dimension (mm)	Cut Out (mm)
DLS-06-12-JL3001	6W	120°	450	Ø110x38	Ø95
DLS-09-12-JL4001	9W		630	Ø140x53.8	Ø120
DLS-15-12-JL5001	15W		1050	Ø180x56	Ø150
DLS-20-12-JL6001	20W		1400	Ø200x61.7	Ø175
DLS-24-12-JL8001	24W		1680	Ø220x67.5	Ø190



### JLS Series-2

**Technical Specification**

- Cyclone type aluminium die-cast heat sink.
- Die-cast aluminium trim.
- High transmit Acrylic diffuser with no glare.
- SMD LED power: 6W, 9W, 15W, 20W, 24W
- Color Temp. (options): 3000K - 5000K
- CRI: ≥80

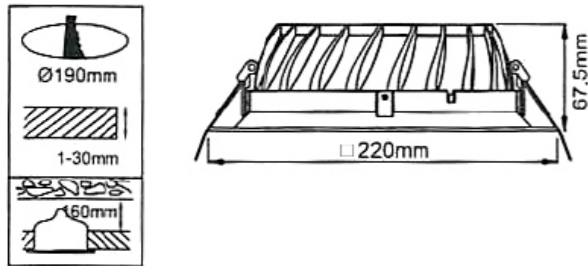

The light intensity distribution curve of polar coordinate

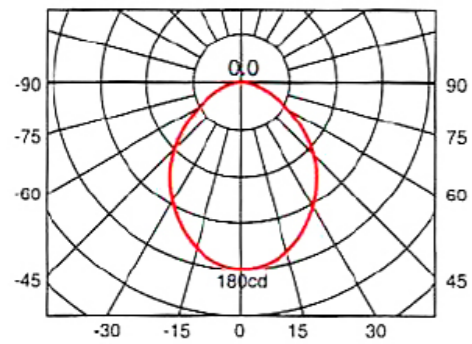

6W

The light intensity distribution curve of polar coordinate

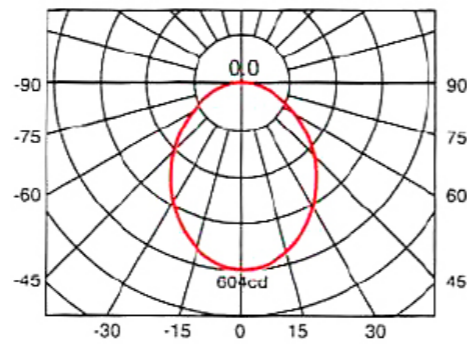

24W

Model	Wattage	Beam Angle	Lumen	Dimension (mm)	Cut Out (mm)
DLS-06-12-JL3001S	6W	120°	450	110x10x38	Ø95
DLS-09-12-JL4001S	9W		630	140x140x53.8	Ø120
DLS-15-12-JL5001S	15W		1050	180x180x56	Ø150
DLS-20-12-JL6001S	20W		1400	200x200x61.7	Ø175
DLS-24-12-JL8001S	24W		1680	220x220x67.5	Ø190



### JLS Series-3

**Technical Specification**

- Cyclone type aluminium die-cast heat sink.
- Die-cast aluminium trim.
- High transmit Acrylic diffuser with no glare.
- SMD LED power: 6W, 9W, 15W, 20W, 24W
- Color Temp. (options): 3000K - 5000K
- CRI: ≥80

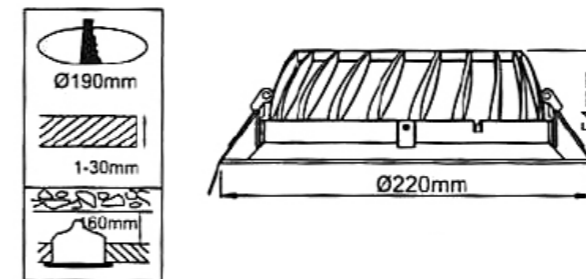

The light intensity distribution curve of polar coordinate

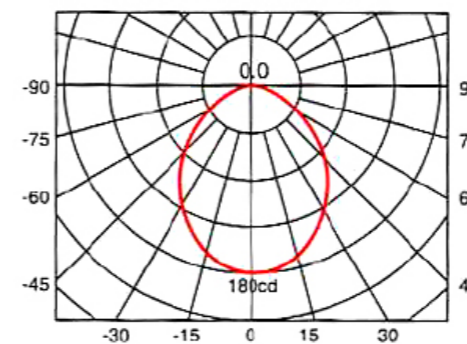

6W

The light intensity distribution curve of polar coordinate

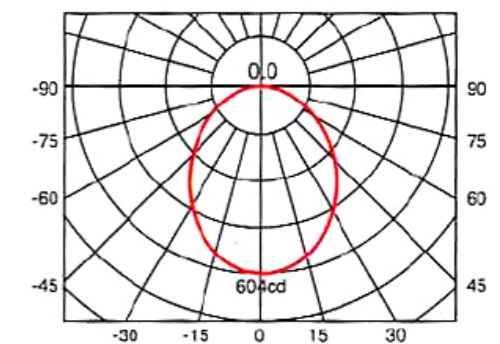

24W

Model	Wattage	Beam Angle	Lumen	Dimension (mm)	Cut Out (mm)
DLS-06-12-JL3001R	6W	120°	450	Ø110x30.7	Ø95
DLS-09-12-JL4001R	9W		630	Ø140x46.3	Ø120
DLS-15-12-JL5001R	15W		1050	Ø180x44.2	Ø150
DLS-20-12-JL6001R	20W		1400	Ø200x51.7	Ø175
DLS-24-12-JL8001R	24W		1680	Ø220x54	Ø190





### JLC Series-1

**Technical Specification**

- Cyclone type aluminium die-cast heat sink.
- Die-cast aluminium trim.
- Clear toughened tempered glass.
- COB LED power: 12W, 15W, 22W, 30W, 36W
- Color Temp. (options): 3000K - 5000K
- CRI: ≥80

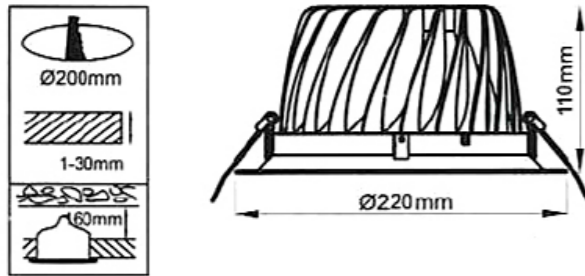

The light intensity distribution curve of polar coordinate

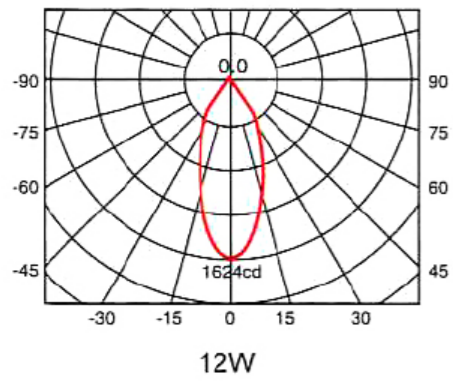

The light intensity distribution curve of polar coordinate

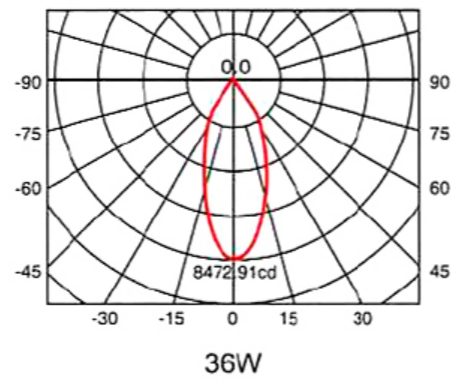

Model	Wattage	Beam Angle	Lumen	Dimension (mm)	Cut Out (mm)
DLC-12-38-JL3002	12W	38°	950	Ø110x67.2	Ø95
DLC-15-38-JL4002	15W		1300	Ø140x76	Ø120
DLC-22-38-JL5002	22W		1800	Ø180x97.2	Ø150
DLC-30-38-JL6002	30W		2300	Ø200x104	Ø175
DLC-36-38-JL8002	36W		2900	Ø220x110	Ø190



### JLC Series-2

**Technical Specification**

- Cyclone type aluminium die-cast heat sink.
- Die-cast aluminium trim.
- Clear toughened tempered glass.
- COB LED power: 12W, 15W, 22W, 30W, 36W
- Color Temp. (options): 3000K - 5000K
- CRI: ≥80

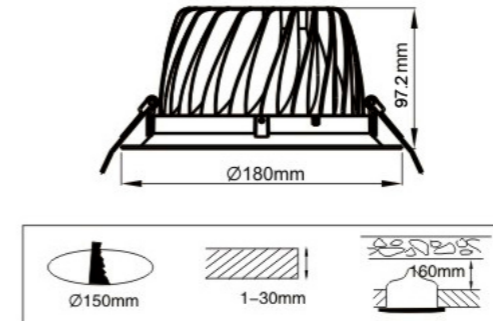

The light intensity distribution curve of polar coordinate

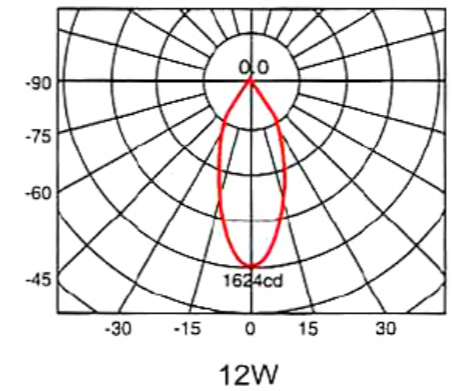

The light intensity distribution curve of polar coordinate

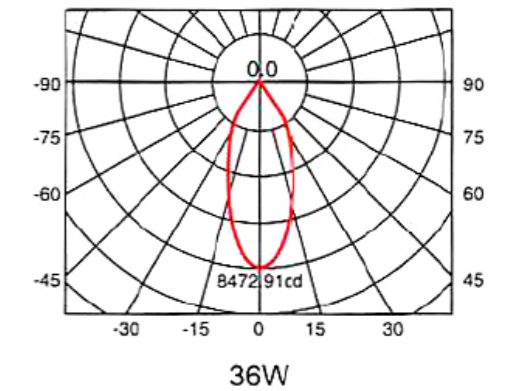

Model	Wattage	Beam Angle	Lumen	Dimension (mm)	Cut Out (mm)
DLC-12-38-JL3002S	12W	38°	950	110x110x67.2	Ø95
DLC-15-38-JL4002S	15W		1300	140x140x76	Ø120
DLC-22-38-JL5002S	22W		1800	180x180x97.2	Ø150
DLC-30-38-JL6002S	30W		2300	200x200x104	Ø175
DLC-36-38-JL8002S	36W		2900	220x220x110	Ø190





### JLC Series-3

**Technical Specification**

- Cyclone type aluminium die-cast heat sink.
- Die-cast aluminium trim.
- Clear toughned tempered glass.
- COB LED power: 12W, 15W, 22W, 30W, 36W
- Color Temp. (options): 3000K - 5000K
- CRI: ≥80

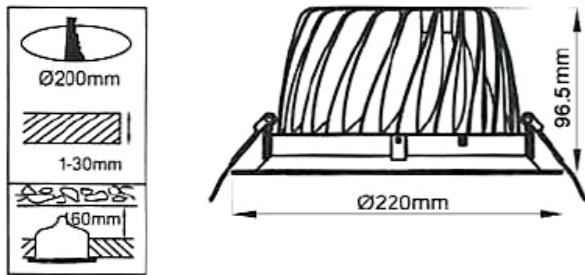

The light intensity distribution curve of polar coordinate

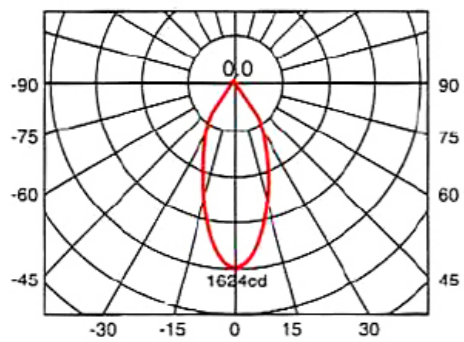

12W

The light intensity distribution curve of polar coordinate

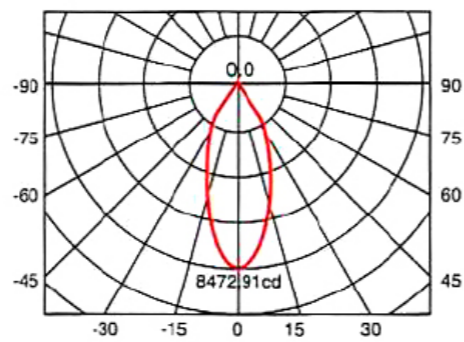

36W

Model	Wattage	Beam Angle	Lumen	Dimension (mm)	Cut Out (mm)
DLC-12-38-JL3002R	12W	38°	950	Ø110x59.4	Ø95
DLC-15-38-JL4002R	15W		1300	Ø140x68.5	Ø120
DLC-22-38-JL5002R	22W		1800	Ø180x85.4	Ø150
DLC-30-38-JL6002R	30W		2300	Ø200x94	Ø175
DLC-36-38-JL8002R	36W		2900	Ø220x96.5	Ø190



## SPOT LIGHT

