

50

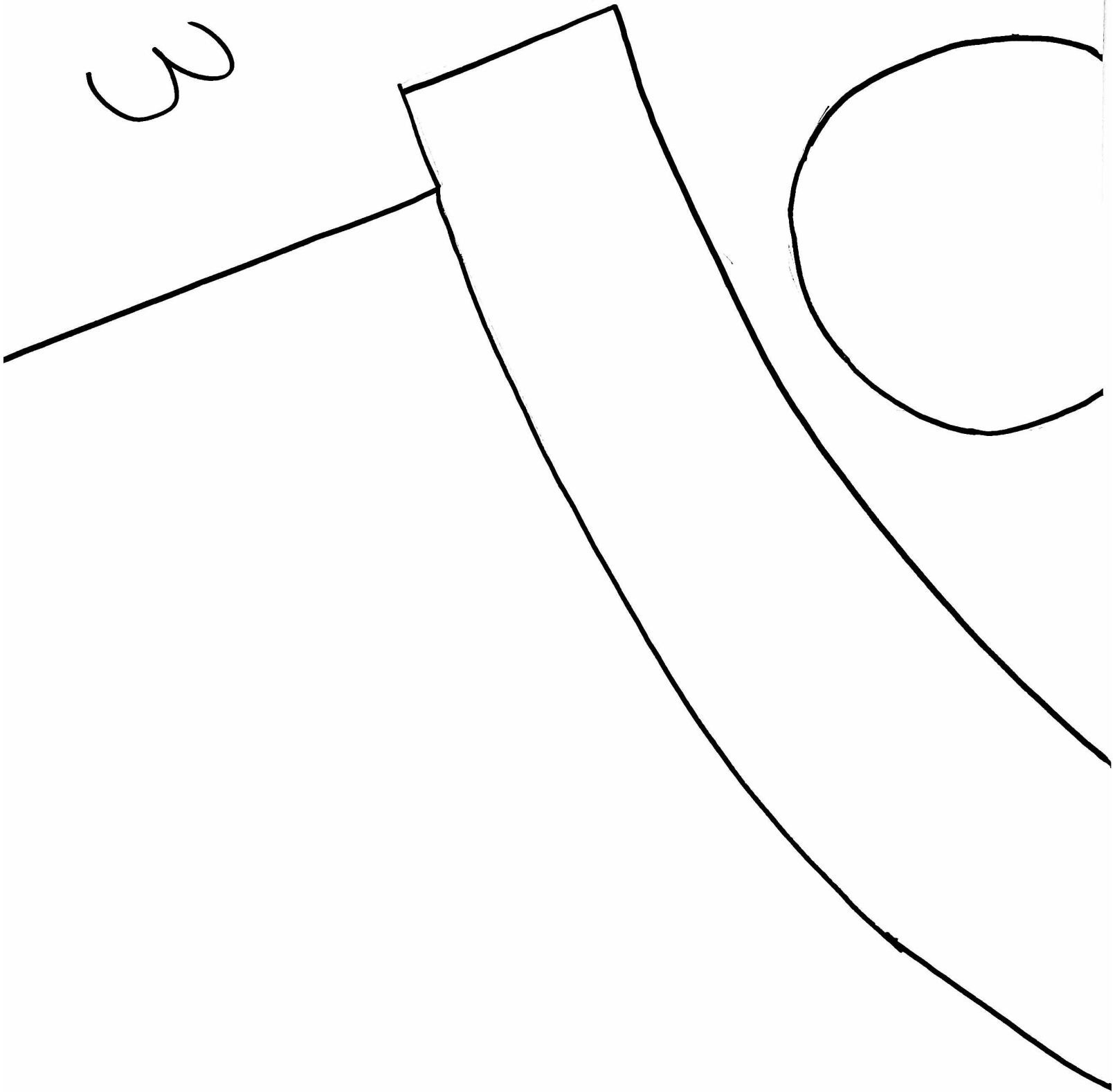

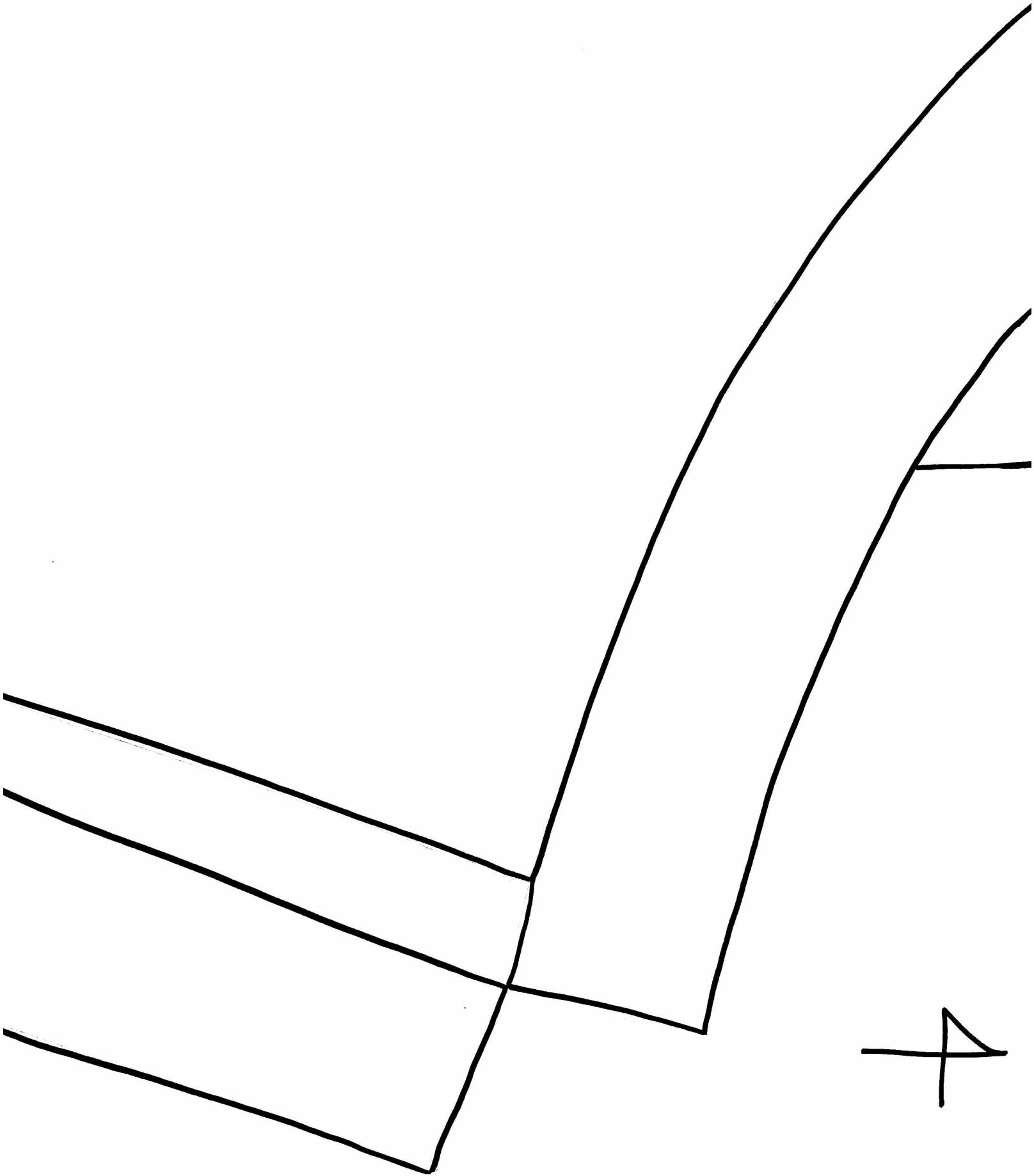

057



