

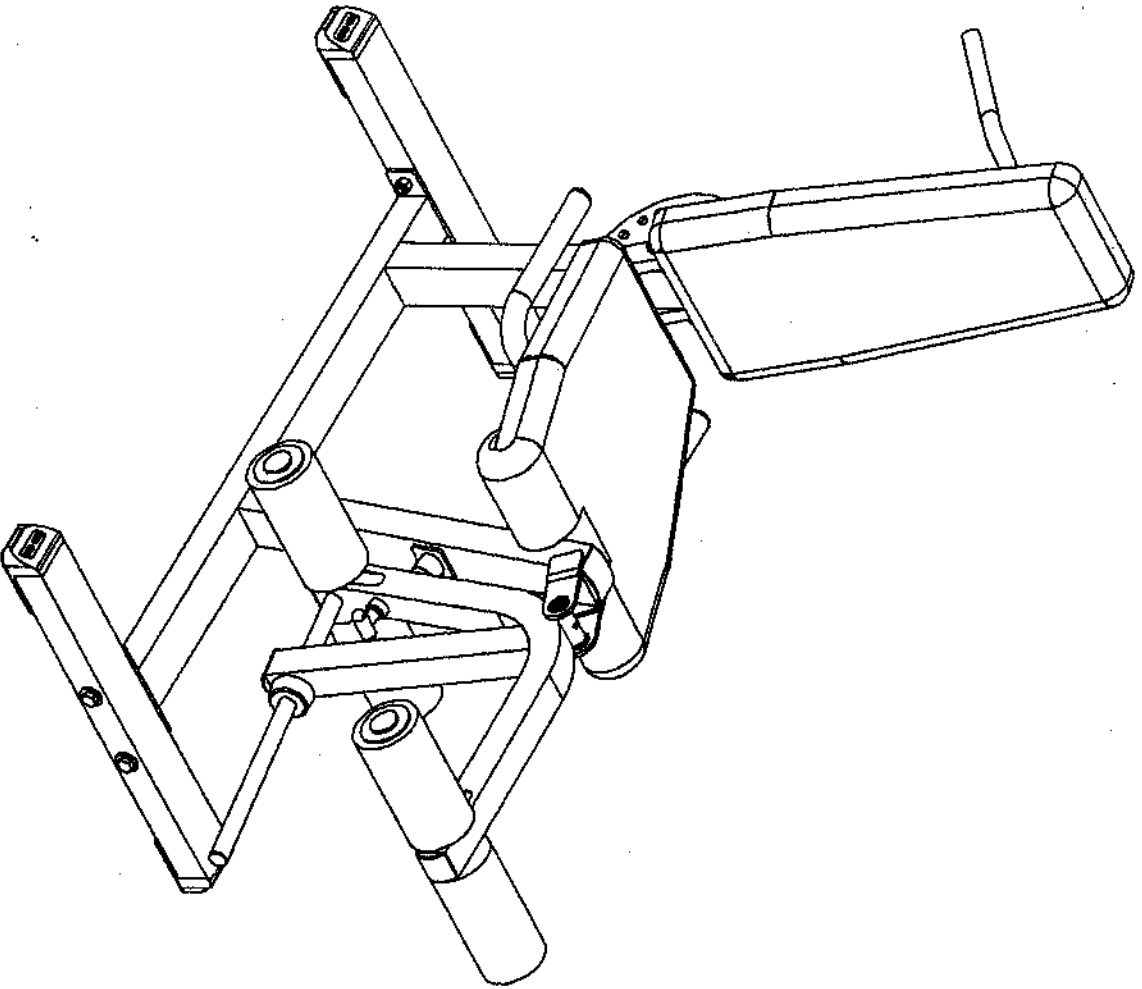

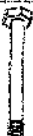

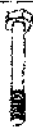





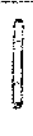

GLCE-365



VERSION 0507

GLCE-365 HARDWARE ILLUSTRATION SHEET

	A1. M12X145 HEX HEAD BOLT	[1PCS]
	A2. M12X100 HEX HEAD BOLT	[4PCS]
	A3. M10X95 HEX HEAD BOLT	[2PCS]
	A4. 5/16"X2 1/4" HEX HEAD BOLT	[4PCS]
	A5. 5/16"X1" HEX HEAD BOLT	[4PCS]
	A6. M12X85 INTERNALLY THREADED SHAFT	[1PCS]
	A7. ϕ 1/2"X152 INTERNALLY THREADED SHAFT	[1PCS]
	B1. M12 NYLON LOCK NUT	[5PCS]
	B2. M10 NYLON LOCK NUT	[2PCS]
	C1. M12 (I.D.) WASHER	[4PCS]
	C2. 5/16" (I.D.) WASHER	[8PCS]
	C3. 5/16" SPRING WASHER	[8PCS]

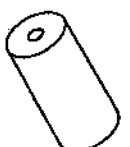
	D1. 2"X2" END CAP(9211-087)	[3PCS]		
	D2. ROUND END CAP(9211-016)	[3PCS]		
	D3. NYLON WASHER(9214-008)	[4PCS]		
	D4. ϕ 1" ROUND END CAP(8341-033)	[4PCS]		
	D5. ROUND END CAP(9260-021)	[4PCS]		
	D6. 20X40 END CAP(9211-008)	[4PCS]		
	D7. 50X75 END CAP(9211-084)	[1PCS]		
	D8. 50X75 FOOT CAP(9211-026)	[4PCS]		
	D9. 4"X8" FOAM ROLLER(9161-009)	[4PCS]		
	D10. 38X75 RUBBER BAR CATCH(9310-002)	[1PCS]		
	D11. ϕ 1" RUBBER DOUNT(9310-014)	[1PCS]		
	D1	D3	D4	
	D5	D6	D7	D8
	D9	D10	D11	

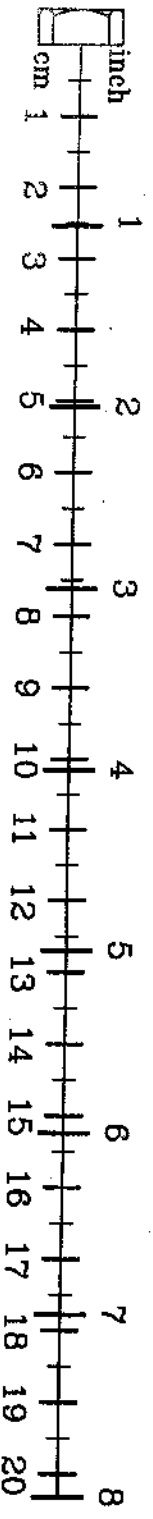

GLCE-365 PARTS ILLUSTRATION SHEET

A [1PCS]

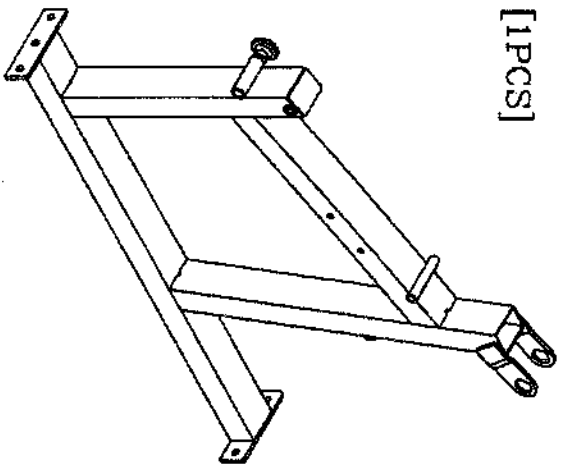

D [1PCS]

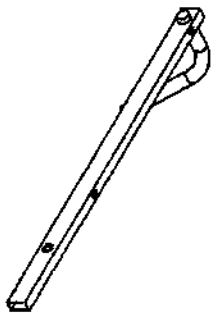

G [2PCS]

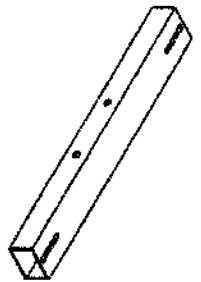

L [1PCS]
9112-016

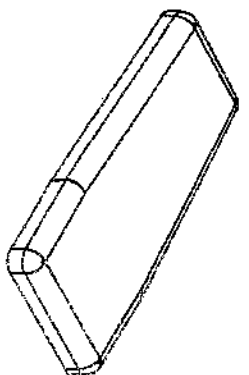

B [1PCS]

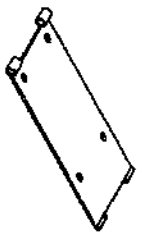

E [1PCS]

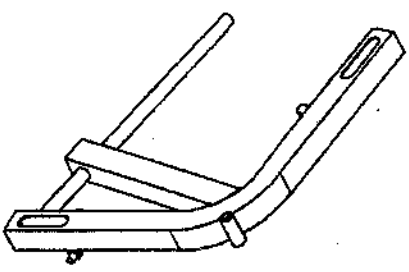

H [2PCS]

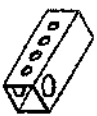

K [1PCS]
9122-028

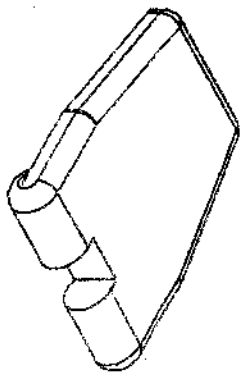

C [1PCS]

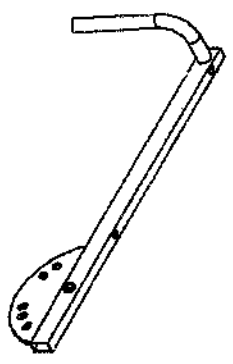

F [1PCS]



I [2PCS]

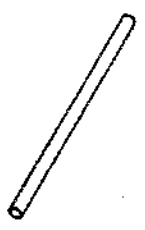

J [1PCS]



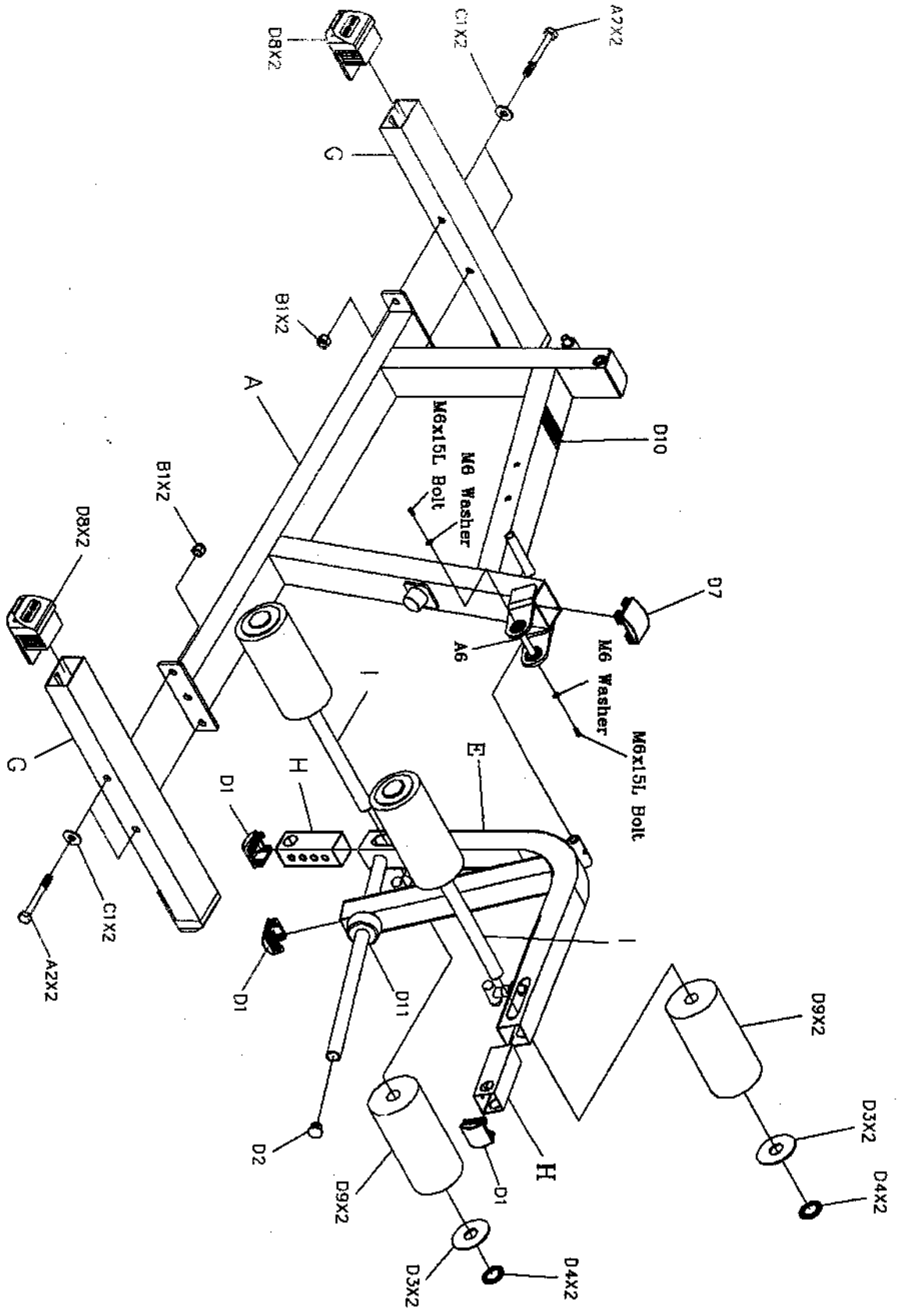

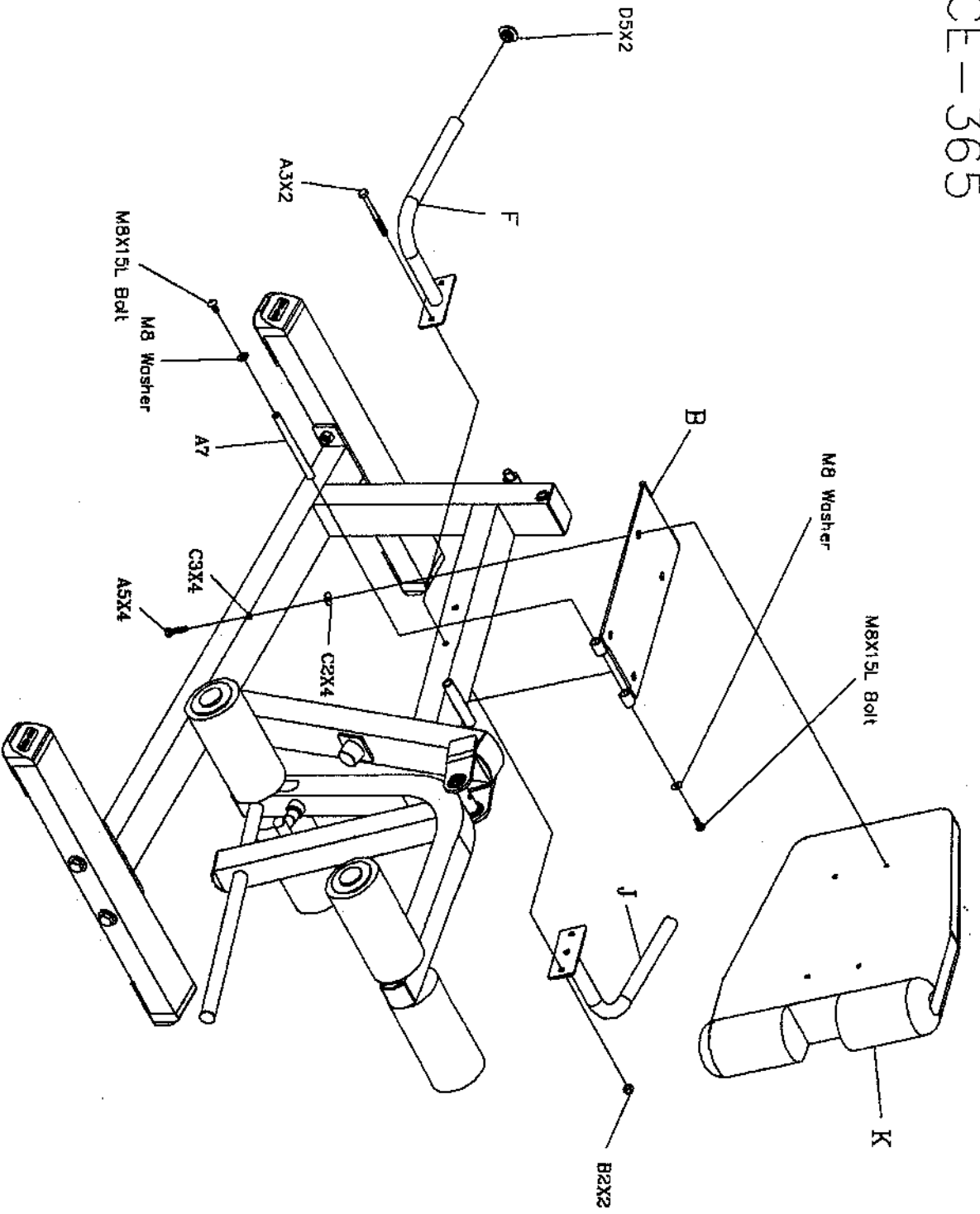

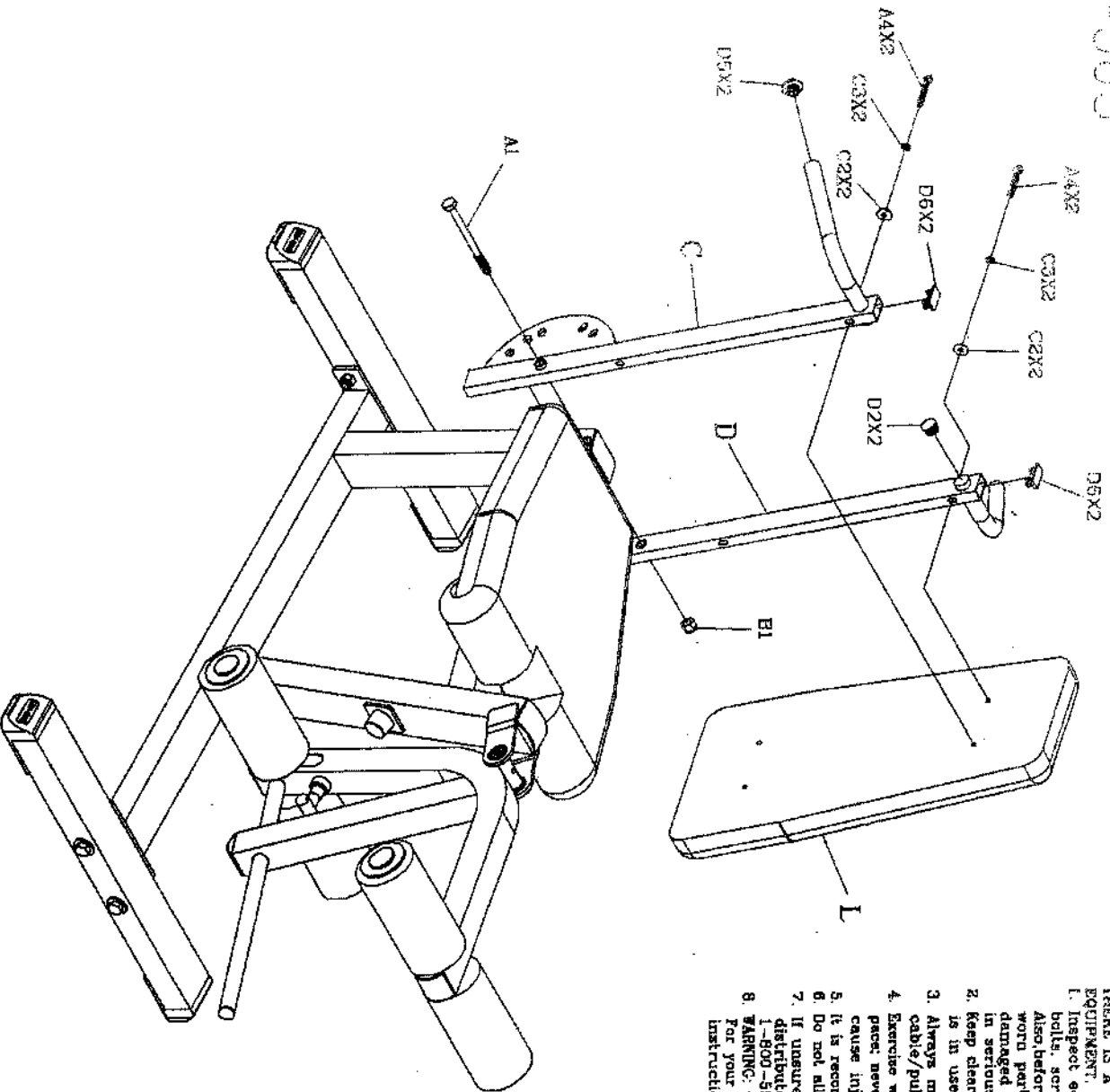

- THERE IS A RISK ASSUMED BY INDIVIDUALS WHO USE THIS TYPE OF EQUIPMENT. TO MINIMIZE RISK, YOU MUST FOLLOW THESE RULES:
1. Inspect equipment before each workout. Check that all nuts, bolts, screws and pop pins are in place and fully tightened. Also, before use, check cables for signs of wear. Replace all worn parts immediately. Never use machine if any parts are damaged or rattling. Failure to follow these rules may result in serious injury.
 2. Keep clear of the cables and all moving parts when the machine is in use.
 3. Always make sure all Snap Links are closed when doing any cable/pulley exercises.
 4. Exercise with care. Perform your exercises at a smooth, moderate pace; never perform jerky or uncoordinated movements that may cause injury.
 5. It is recommended that you should workout with a training partner.
 6. Do not allow children or minors to play on or around this equipment.
 7. If unsure of proper use of equipment, call your local Body-Solid distributor or the Body-Solid customer service department at 1-800-556-3113.
 8. **WARNING:** Consult your physician before starting your exercise program. For your own safety, do not begin any exercise program without proper instruction.

FAL2-11-98