

Body-Solid

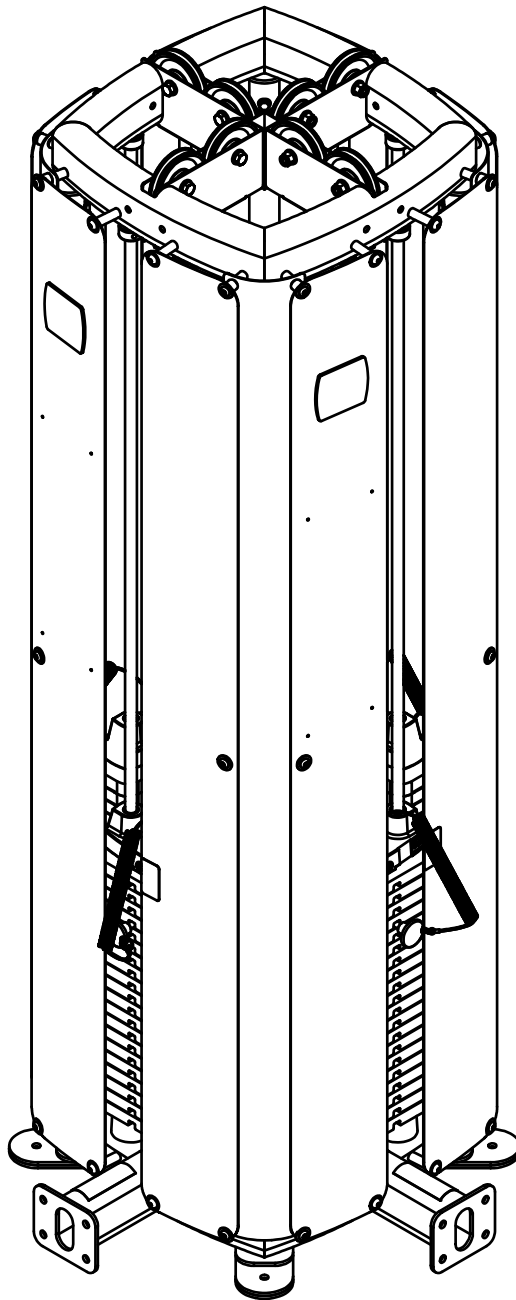

BODY-SOLID, Inc.
1900 S. Des Plaines Ave.
Forest Park, IL 60130 USA
Phone: (708) 427-3555
Fax: (708) 427-3556
www.bodysolid.com

DGYM.1 OWNER'S MANUAL

DGYM ASSEMBLY INSTRUCTIONS

HARDWARE ILLUSTRATION

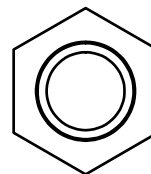
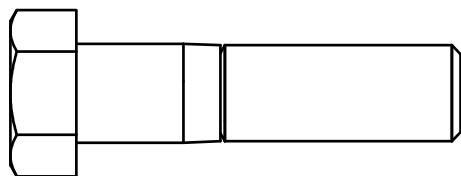

(A1)HEX BOLT 1/2"x2"L PARTIAL THREAD QTY.8

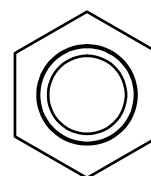
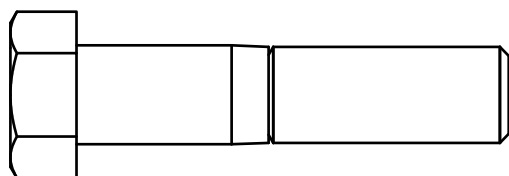

(A2)HEX BOLT 1/2"x2 1/4"L PARTIAL THREAD QTY.8

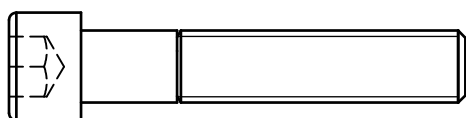

(A3)ROUND ALLEN HEAD 3/8"x2"L PARTIAL THREAD QTY.4

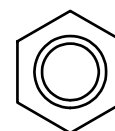
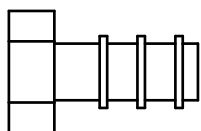

(A4)HEX BOLT 3/8"x3/4"L PARTIAL THREAD QTY.16

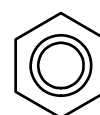
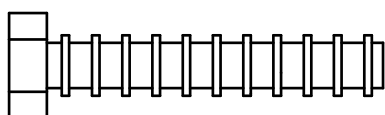

(A5)HEX BOLT 5/16"x1 3/4"L PARTIAL THREAD QTY.4

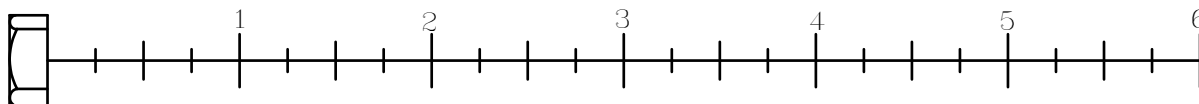

DGYM ASSEMBLY INSTRUCTIONS

HARDWARE ILLUSTRATION

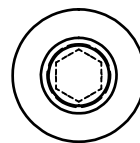
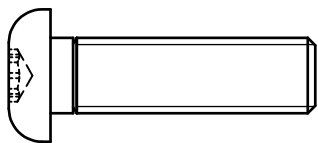

(A6)ROUND ALLEN HEAD M10X35L PARTIAL THREAD QTY.8



(A12)ROUND ALLEN HEAD 5/32"X1/4"L PARTIAL THREAD QTY.16

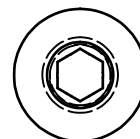
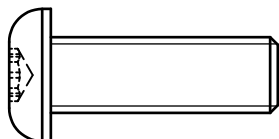

(A13)ROUND ALLEN HEAD M10X30L PARTIAL THREAD QTY.4

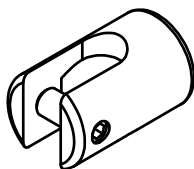

(A14)FIRM SHEATH(8890-046) QTY.4

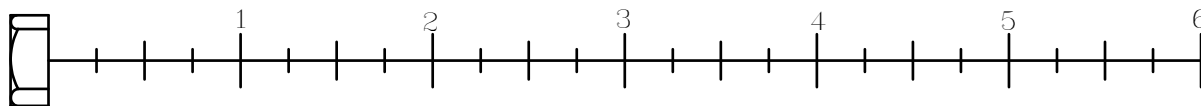

DGYM ASSEMBLY INSTRUCTIONS

HARDWARE ILLUSTRATION

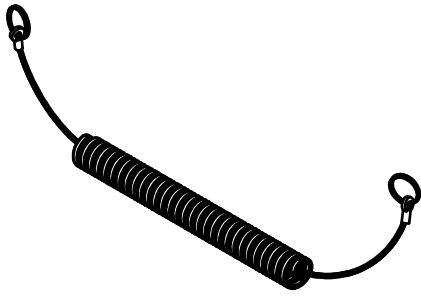

(A8)ELASTIC BOLT QTY.4

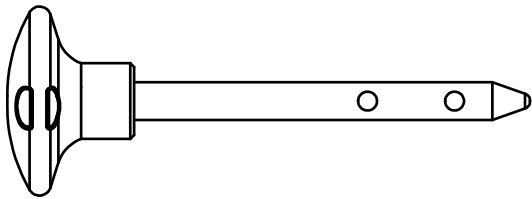

(A9)10LB PIN (8250-071) QTY.4

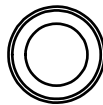
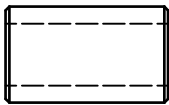

(A11)IMMOBILE COVER Ø1/2"XØ8.5X21.5L(8690-012) QTY.4

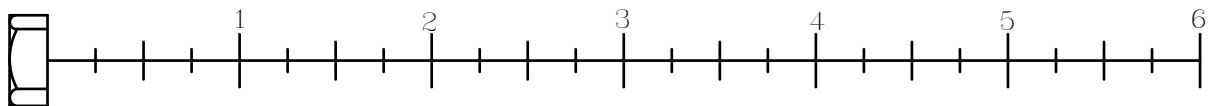

DGYM ASSEMBLY INSTRUCTIONS

HARDWARE ILLUSTRATION

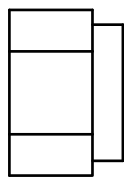

(B1) NYLON LOCK NUT 1/2" QTY.16

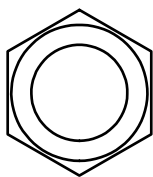

(B2) NYLON LOCK NUT 5/16" QTY.4

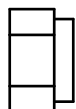

(B4) NYLON LOCK NUT M10 QTY.8

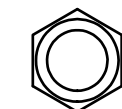

(B5) NYLON LOCK NUT M10 QTY.4

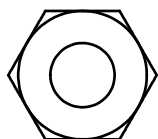

(C2) M10(I.D.) FLAT CURVED WASHER R30 \varnothing 20 QTY.16

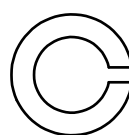
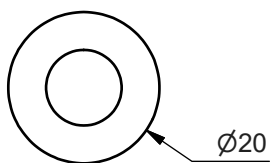

(C3) 3/8"(I.D.) SPRING WASHER QTY.4

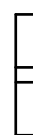

(C4) 5/16"(I.D.) FLAT WASHER \varnothing 16 QTY.8

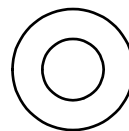

(C6) M10(I.D.) FLAT WASHER \varnothing 27 QTY.16

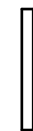

(C7) 1/2"(I.D.) FLAT WASHER \varnothing 25 QTY.32

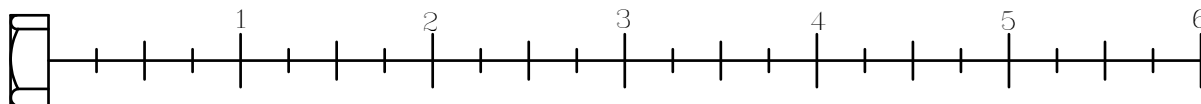
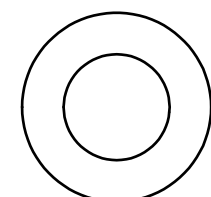
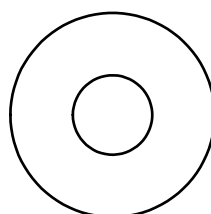

DGYM ASSEMBLY INSTRUCTIONS

HARDWARE ILLUSTRATION

D1.Ø3/4"X8L STEEL BUSHING (8110-014)	[8PCS]
D2.Ø3/4"X19.5L STEEL BUSHING (8110-017)	[24PCS]
D3.Ø3/4" SHAFT COLLAR(9211-046)	[8PCS]
D4.Ø65XØ20X70L RUBBER DOUNT(9310-049)	[8PCS]
D5.95X250 RUBBER PAD(9310-060)	[4PCS]
D7.Ø117 PULLEY(9213-010B)	[16PCS]
D8.TOP PLATE(8400-006)	[4PCS]
D9.2040mm STEEL CABLE(FDGYMA)	[4PCS]
D10.WEIGHT SELECTOR BAR(8210-042B)	[4PCS]

D1



D2



D3



D4

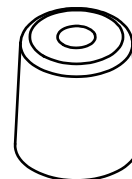

D5

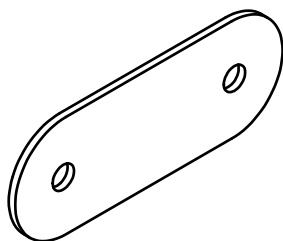

D7

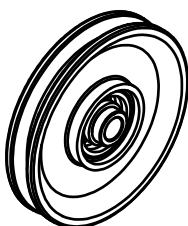

D8

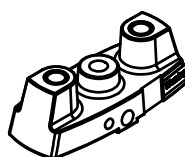

D9

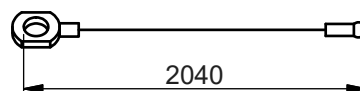

D10

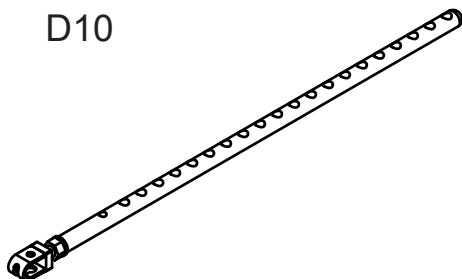

DGYM ASSEMBLY INSTRUCTIONS

HARDWARE ILLUSTRATION

D11.4705mm DABB For DGYM Steel Cable(FDABBB)	[1PCS]
D12.4900mm DBTC For DGYM Steel Cable(FDBTCB)	[1PCS]
D13.4350mm DCLP For DGYM Steel Cable(FDCLPC)	[1PCS]
D14.3170mm DIOT For DGYM Steel Cable(FDIOTC)	[1PCS]
D15.7485mm DLAT For DGYM Steel Cable(FDLATC)	[1PCS]
D16.4840mm DLEC For DGYM Steel Cable(FDLECB)	[1PCS]
D17.4490mm DPCC For DGYM Steel Cable(FDPCCC)	[1PCS]
D18.4490mm DPEC For DGYM Steel Cable(FDPECC)	[1PCS]
D19.8560mm DPLS For DGYM Steel Cable(FDPLSB)	[1PCS]
D20.3805mm DPRS For DGYM Steel Cable(FDPRSC)	[1PCS]

D11

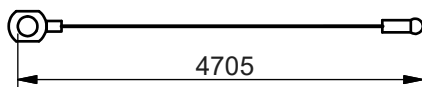

D16

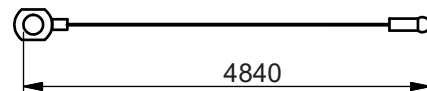

D12

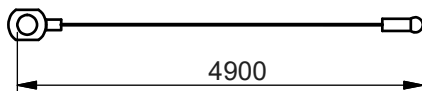

D17

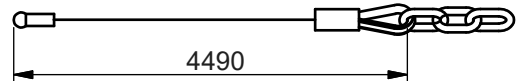

D13

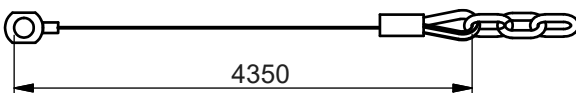

D18

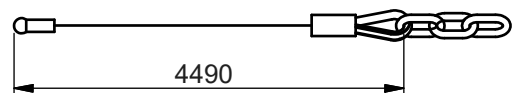

D14

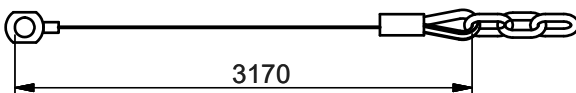

D19

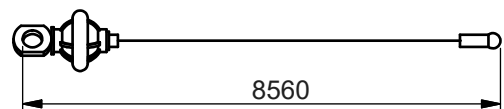

D15

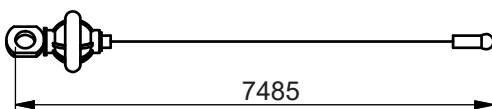

D20

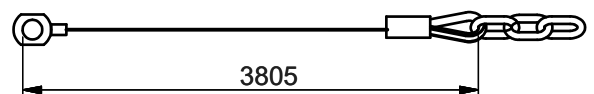

DGYM ASSEMBLY INSTRUCTIONS

PARTS ILLUSTRATION SHEET

A[1PCS]
6610-004

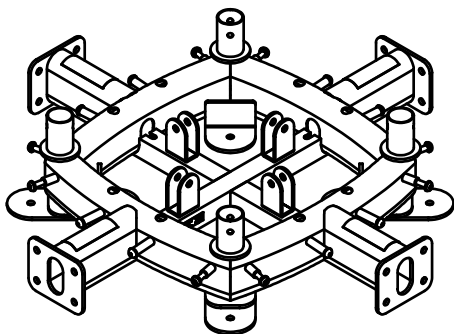

B[1PCS]
6610-005

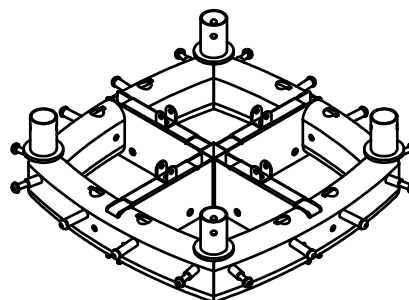

C[4PCS]
6610-006

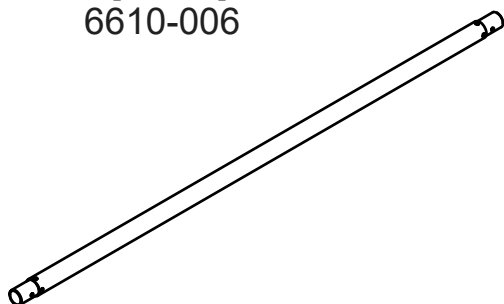

D[4PCS]
6640-001

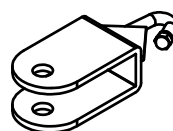

E[4PCS]
8380-055

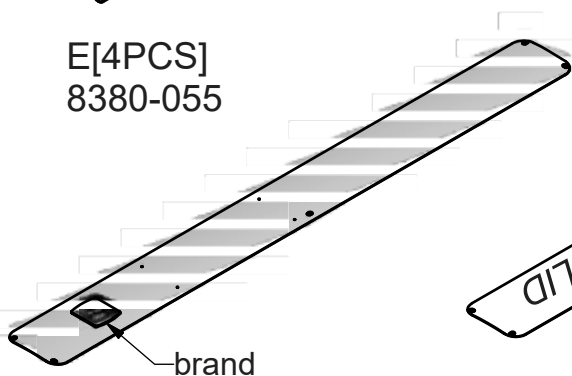

F[4PCS]
8380-053

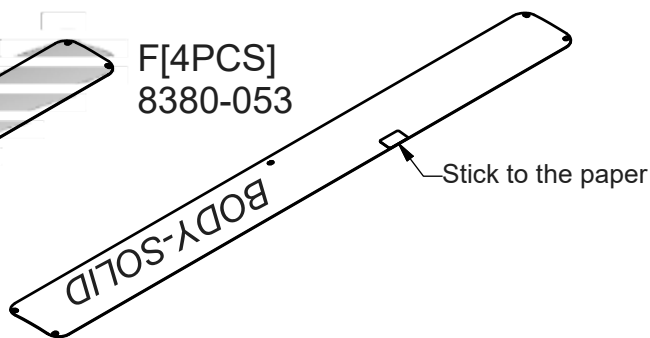

G[4PCS]
8380-054

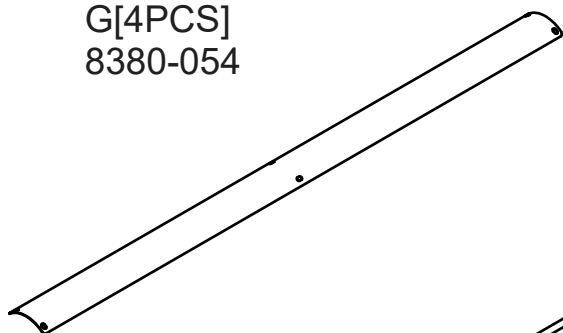

H[8PCS]
5313-Y002

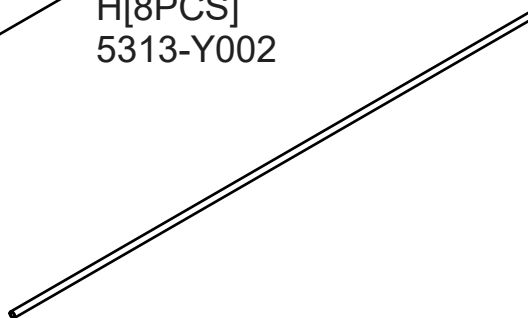

DGYM ASSEMBLY INSTRUCTIONS

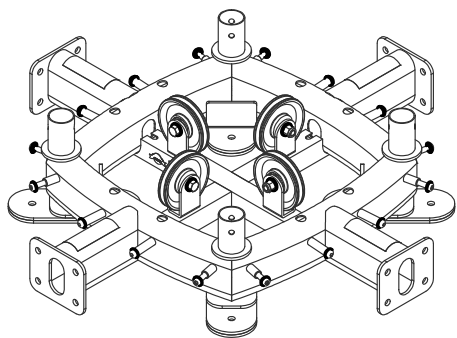

Above shows STEP 1
assembled and completed

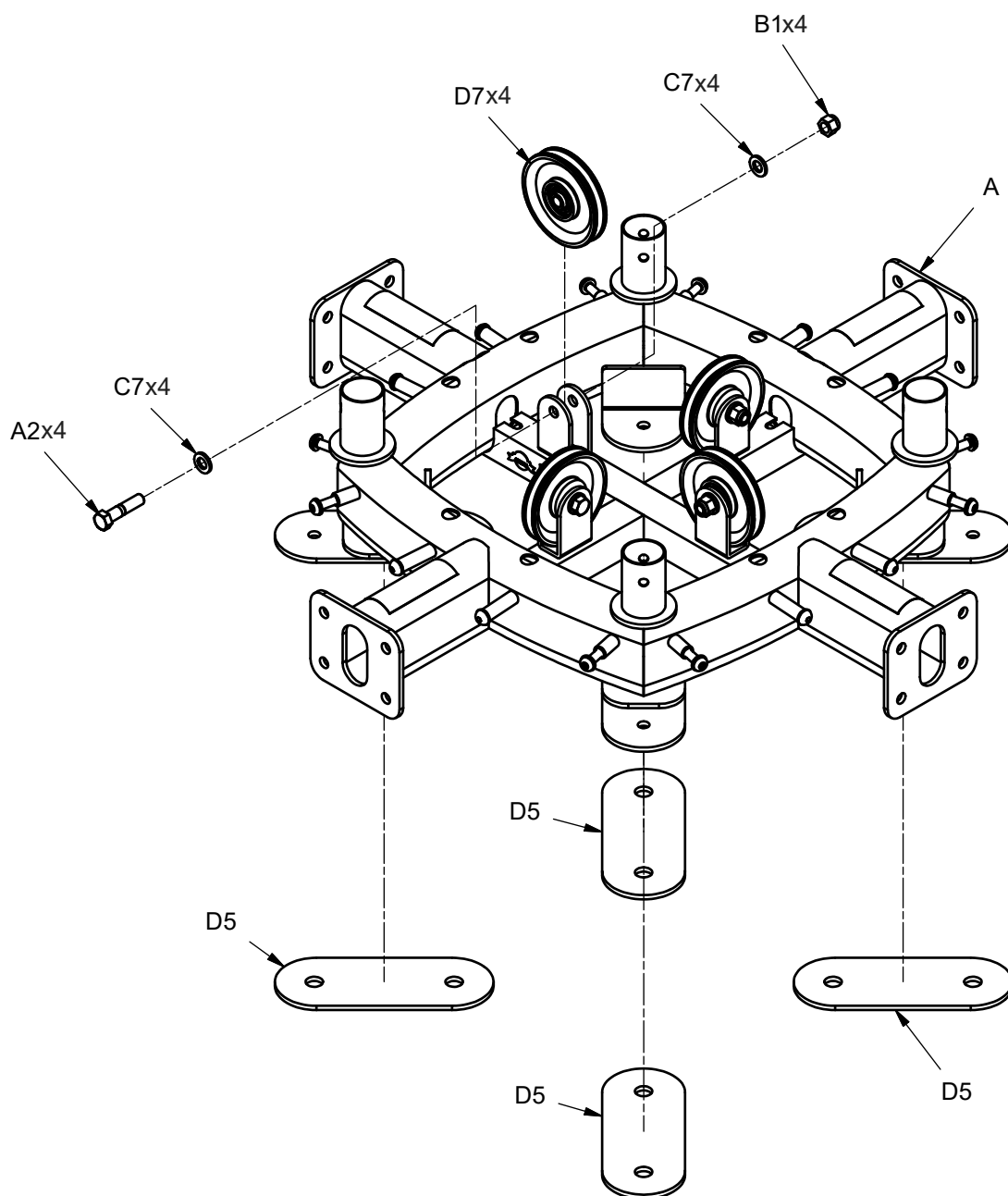

DGYM ASSEMBLY INSTRUCTIONS

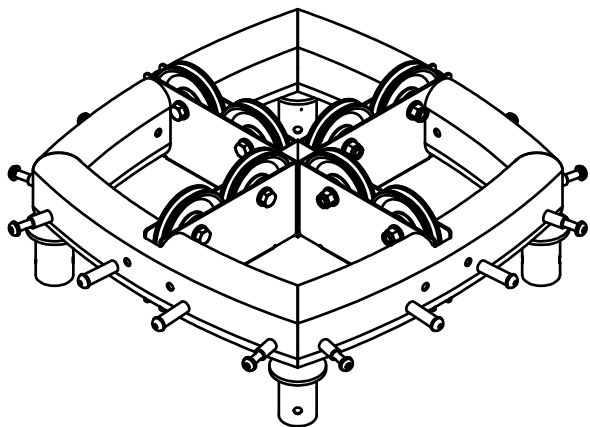

Above shows STEP 2
assembled and completed

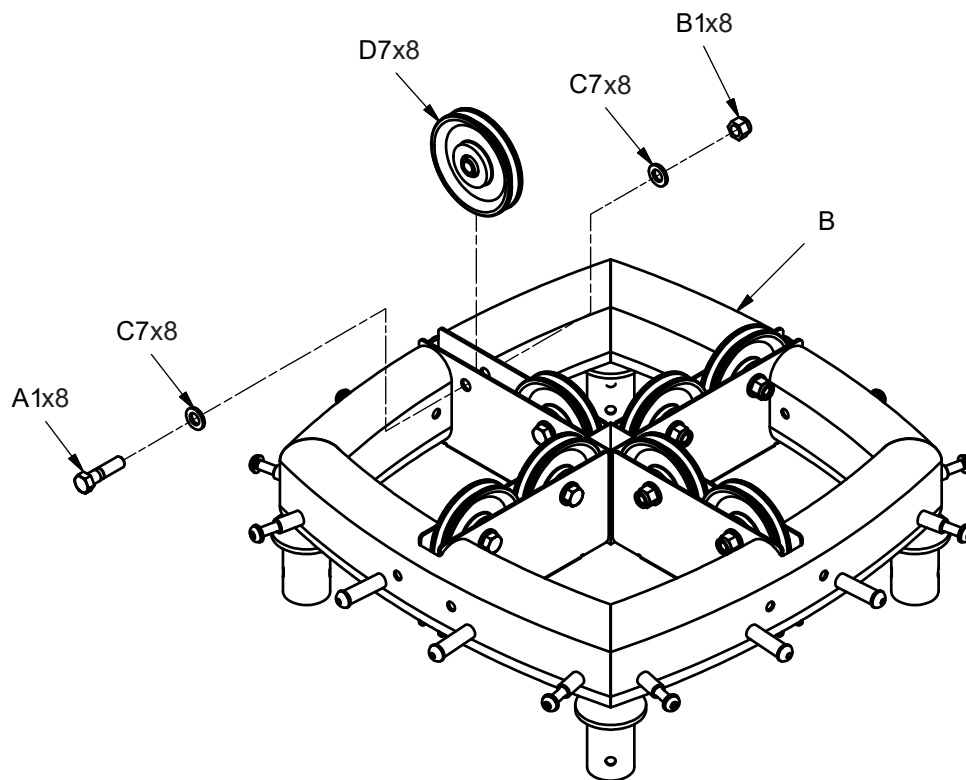

DGYM ASSEMBLY INSTRUCTIONS

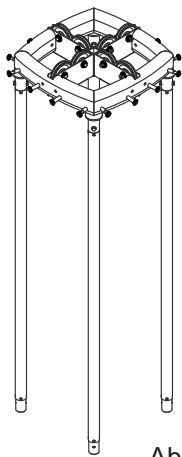

Above shows STEP 3
assembled and completed

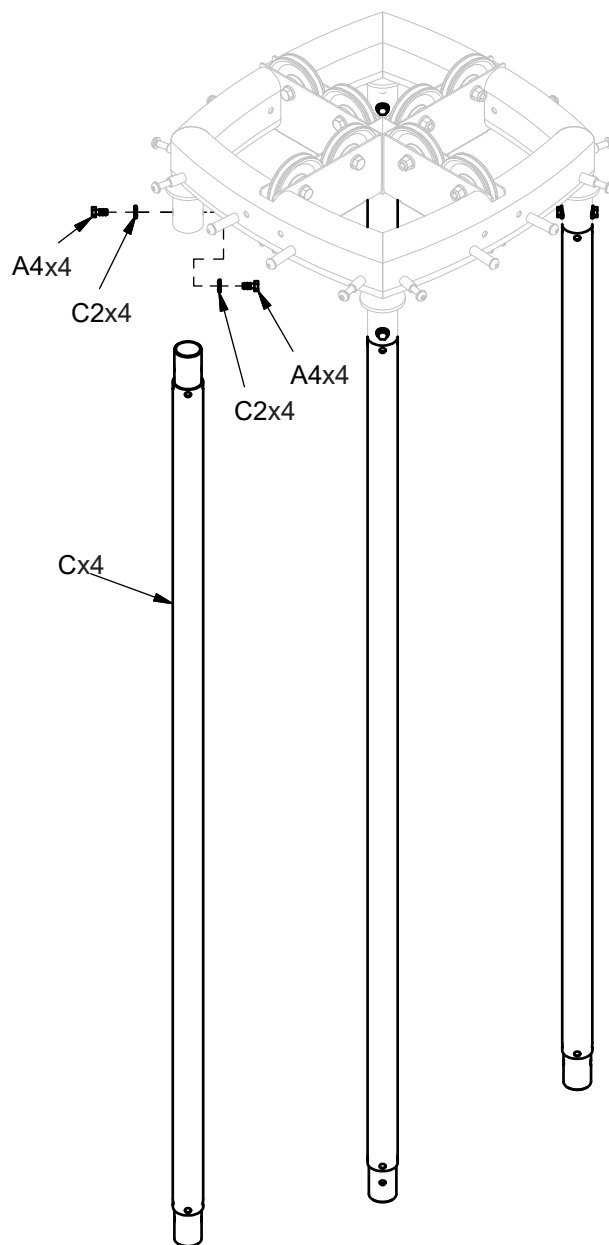

DGYM ASSEMBLY INSTRUCTIONS

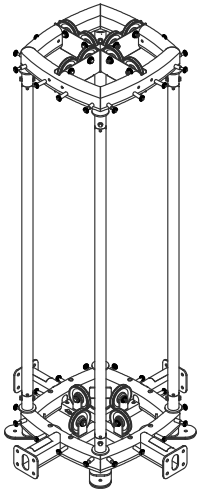

Above shows STEP 4
assembled and completed

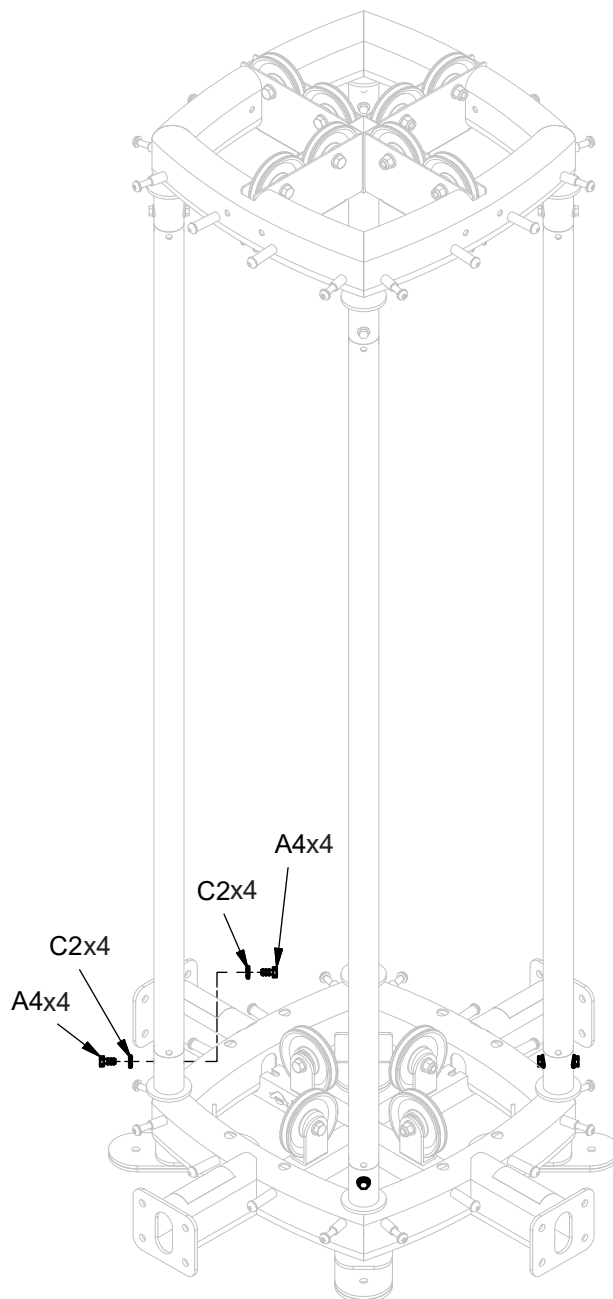

DGYM ASSEMBLY INSTRUCTIONS

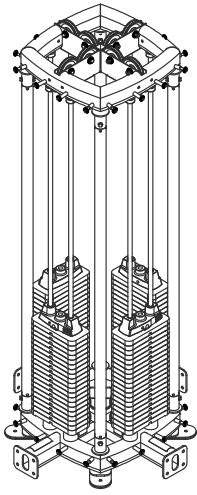

Above shows STEP 5 assembled and completed

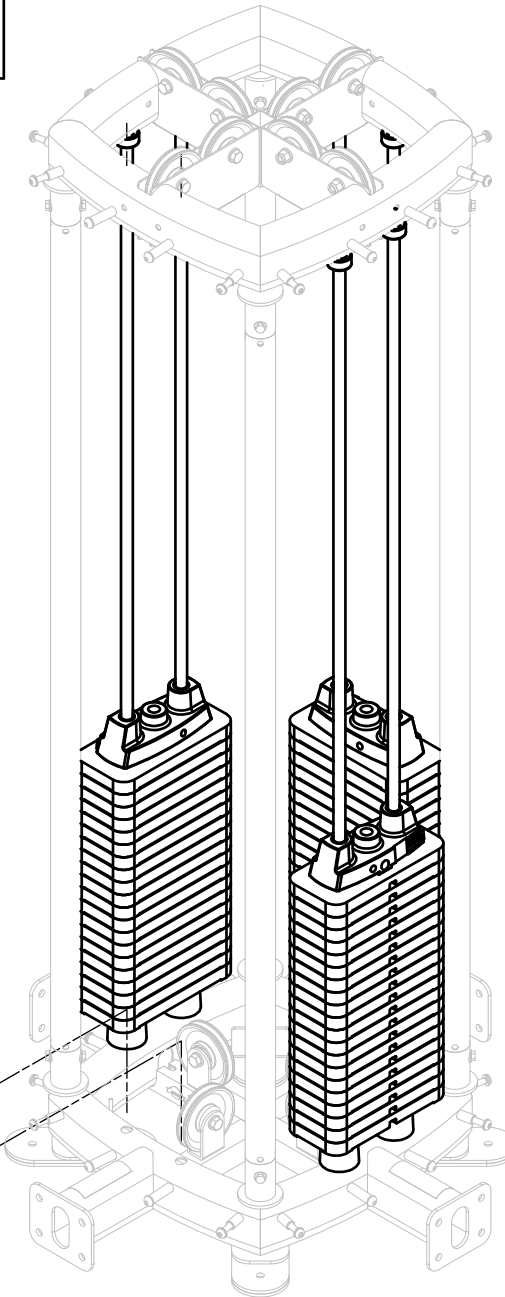
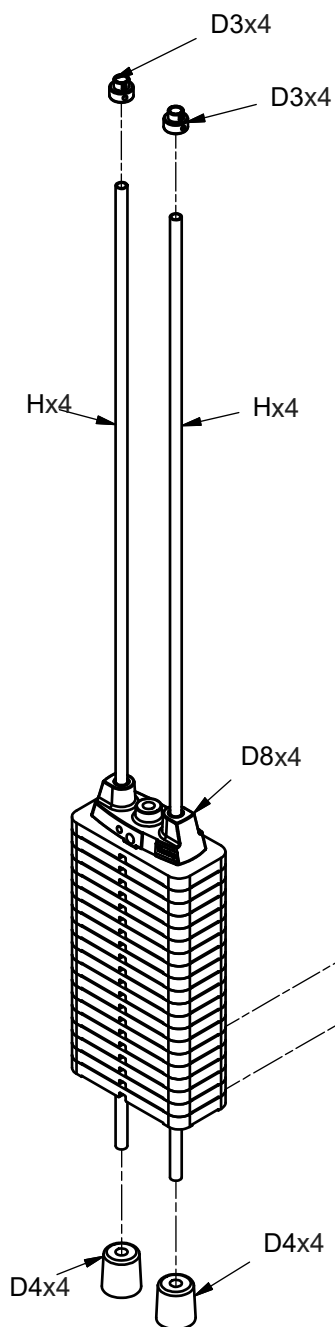

DGYM ASSEMBLY INSTRUCTIONS

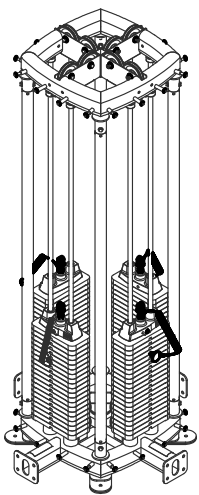

Above shows STEP 6
assembled and completed

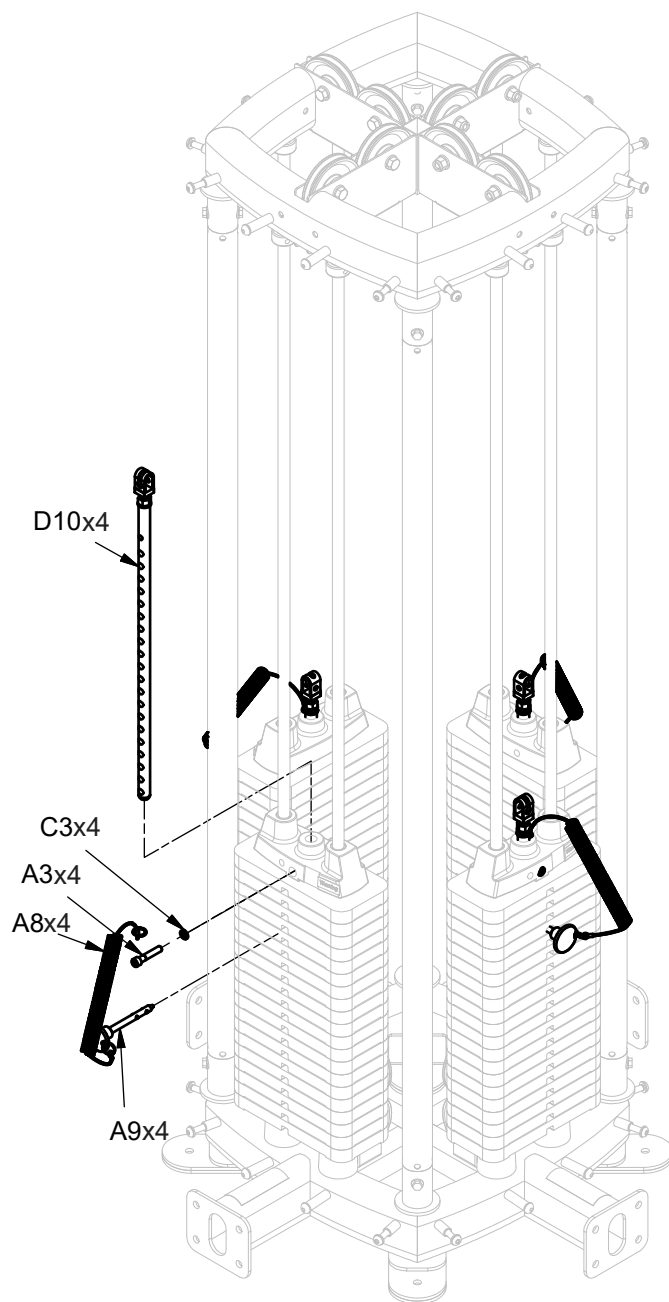

DGYM ASSEMBLY INSTRUCTIONS

Cable to match illustration

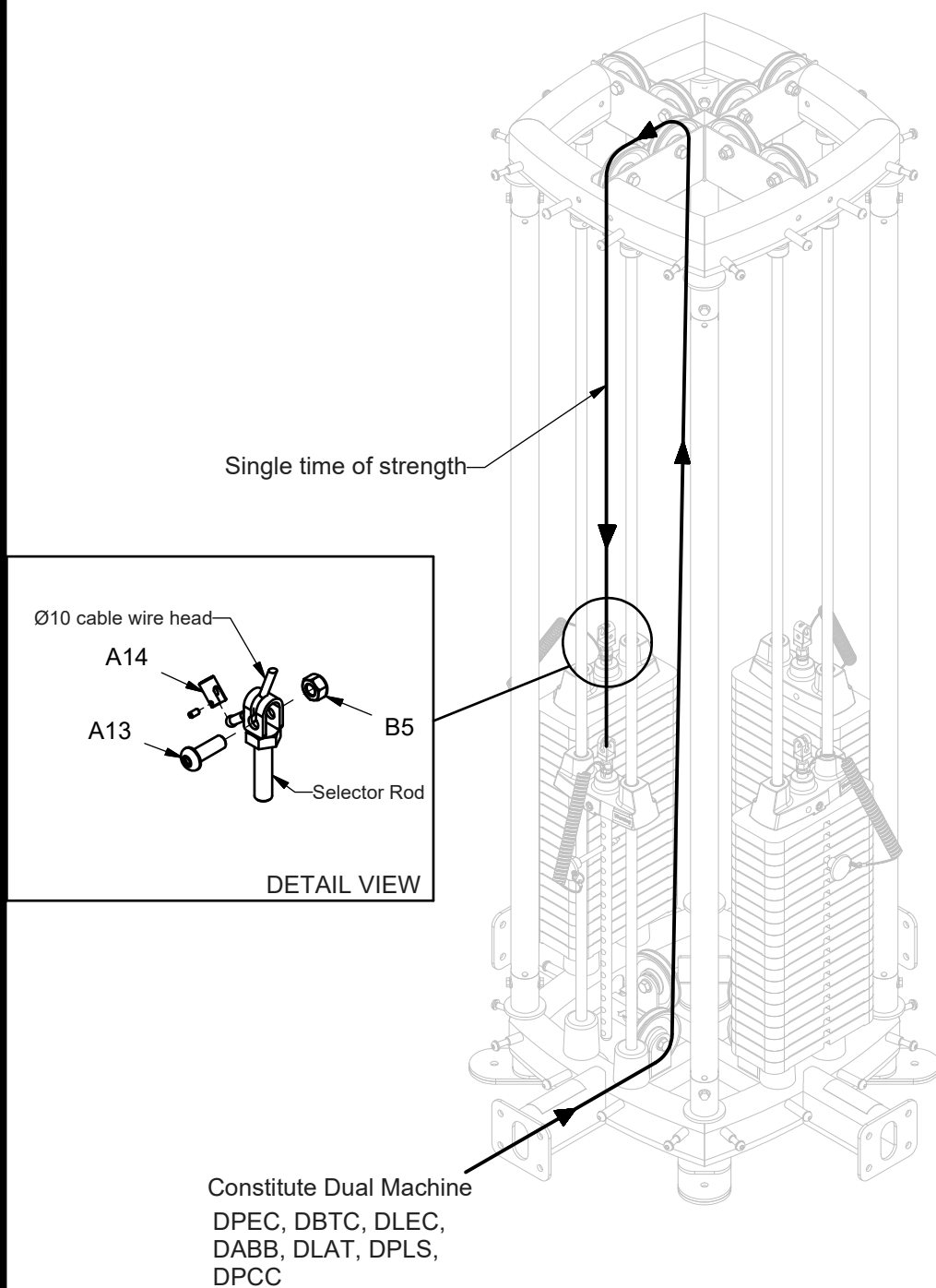

DGYM ASSEMBLY INSTRUCTIONS

Cable to match illustration

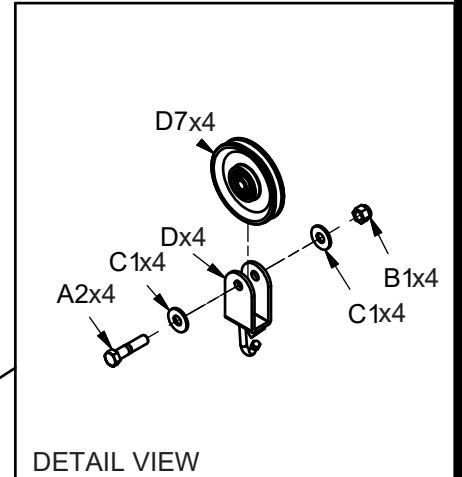
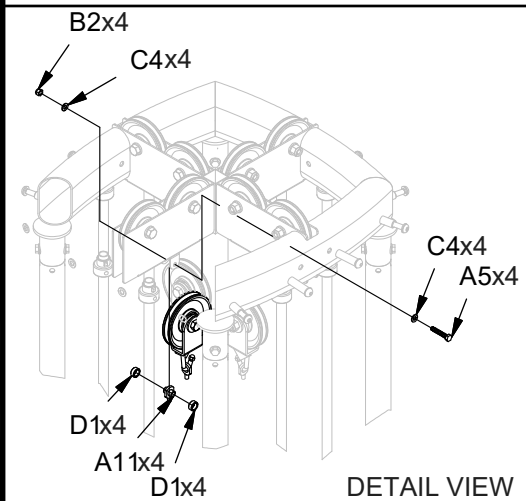

Double strength(D9)

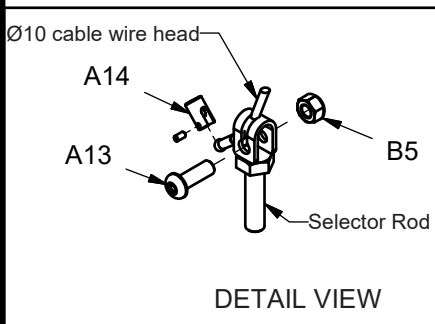

Constitute Dual Machine
DCLP, DIOT, DPRS

DGYM ASSEMBLY INSTRUCTIONS

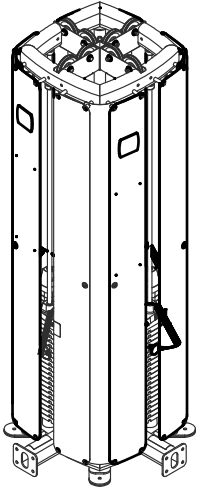

Above shows STEP 7 assembled and completed

