

# Rectal Speculae

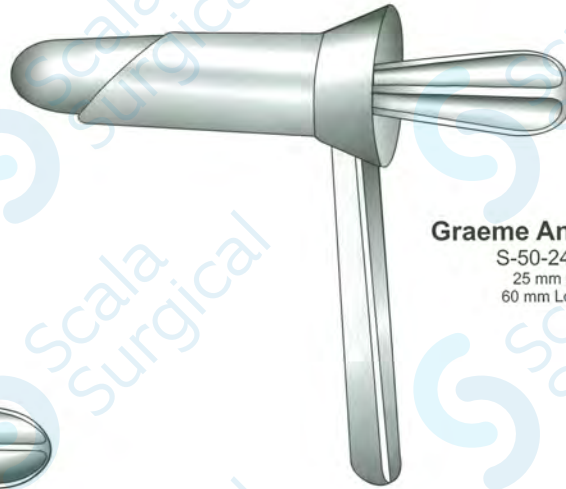

**Graeme Anderson**  
S-50-2409  
25 mm Ø  
60 mm Long

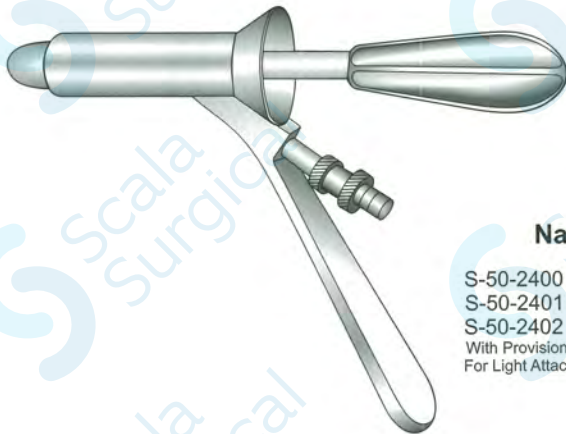

### Naunton Morgan

64 mm Length

S-50-2400 Small, 17 mm Ø	S-50-2404
S-50-2401 Medium, 21 mm Ø	S-50-2405
S-50-2402 Large, 24 mm Ø	S-50-2406
With Provision For Light Attachment	Without Light Attachment



### Kelly Proctoscope

S-50-2419	23 x 100 mm
S-50-2421	24 x 140 mm
S-50-2423	25 x 200 mm



### Kelly Proctoscope

S-50-2415	22 x 50 mm
S-50-2417	27 x 50 mm

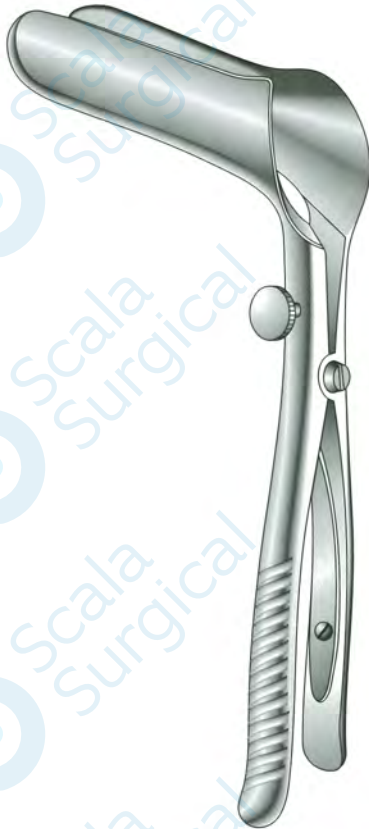

**Eisenhammer's**  
S-50-2425



**Pratt**  
S-50-2428

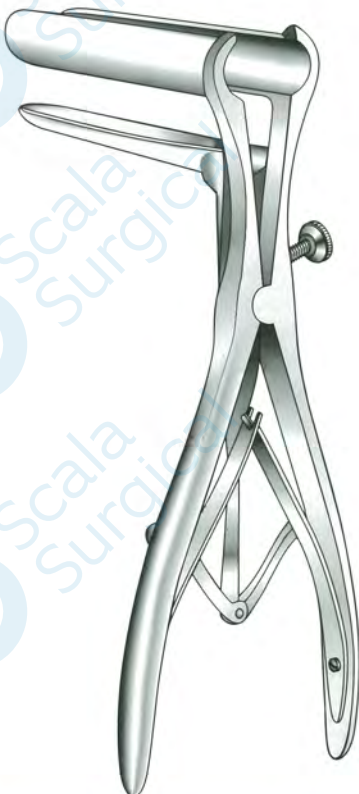

**Mathieu**  
S-50-2430



**Fansler**  
S-50-2432  
73 mm Long  
34 mm Ø  
18 mm wide parallel slot

# Rectal Speculum

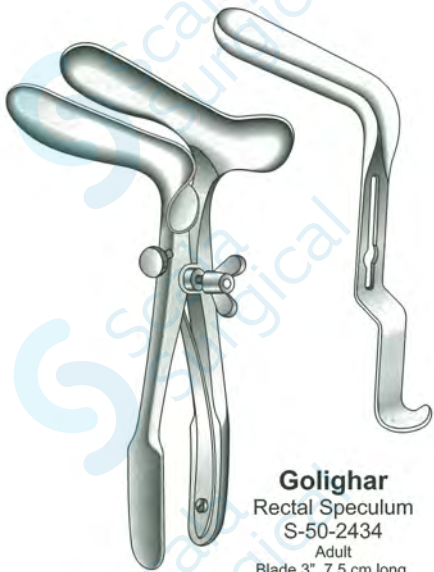

**Golighar**  
Rectal Speculum  
S-50-2434  
Adult  
Blade 3", 7.5 cm long,  
For internal anal sphincterotomy,  
Chromium plated with third anterior blade

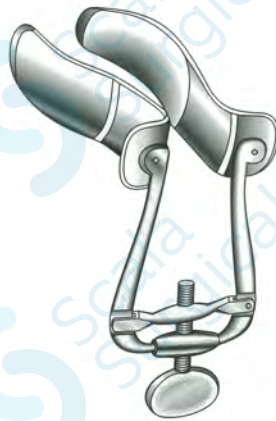

**Park's**  
S-50-2436  
Adult  
Blade 90 mm long, width 25 mm  
Tapering to 17 mm  
S-50-2438  
Child  
Blade 70 mm long, width 23 mm  
Tapering to 15 mm

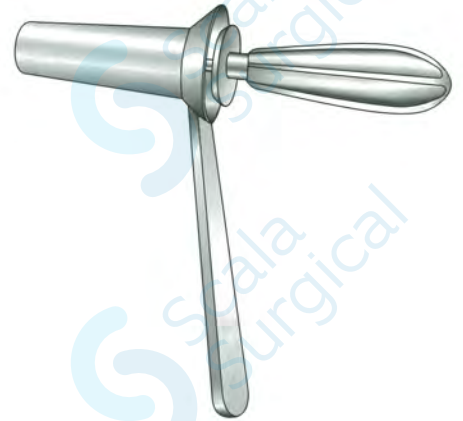

**Gabriel**  
Rectal Speculum  
S-50-2440 Child size 18 mm Ø  
S-50-2442 Adult size 25 mm Ø

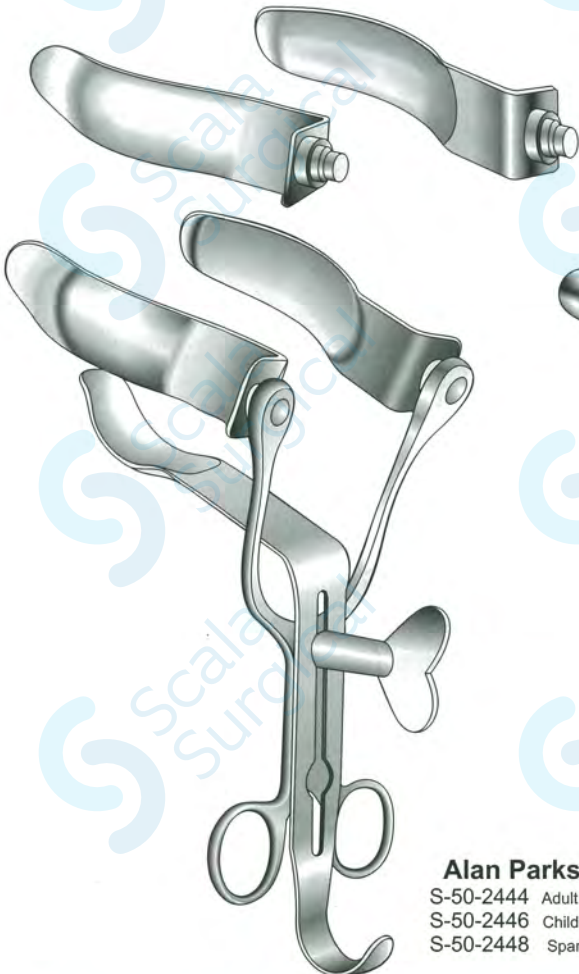

**Alan Parks**  
S-50-2444 Adult  
S-50-2446 Child  
S-50-2448 Spare Blades



**Sims**  
S-50-2450  
Blade 17 mm Wide  
Blade 77 mm Long  
Solid Blade



**Sims**  
S-50-2452  
Blade 17 mm Wide  
Blade 77 mm Long  
Fenestrated Blades

**Rectal Speculum**

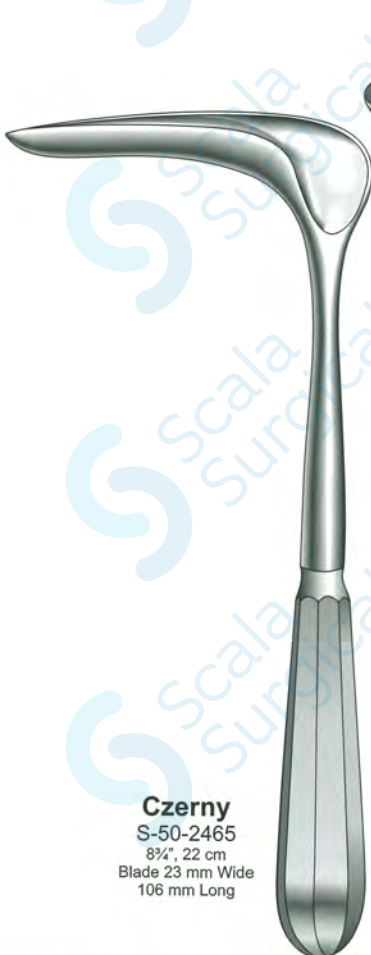
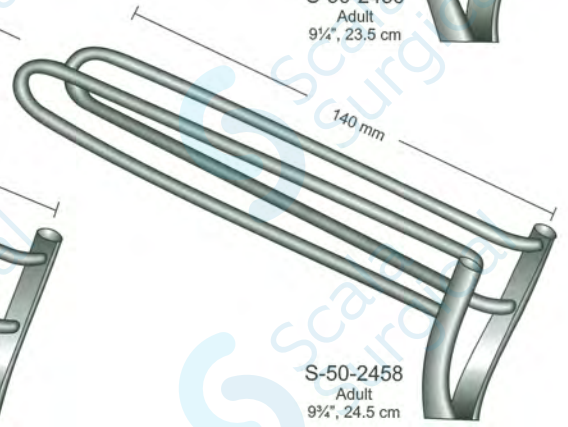
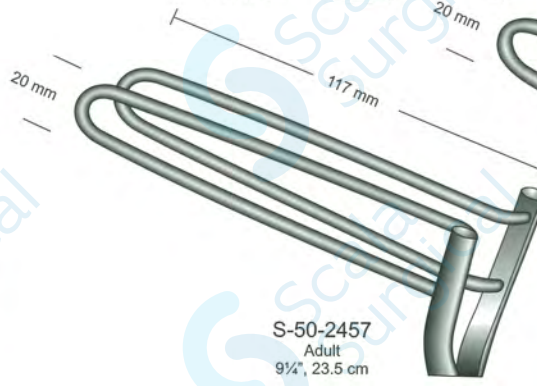
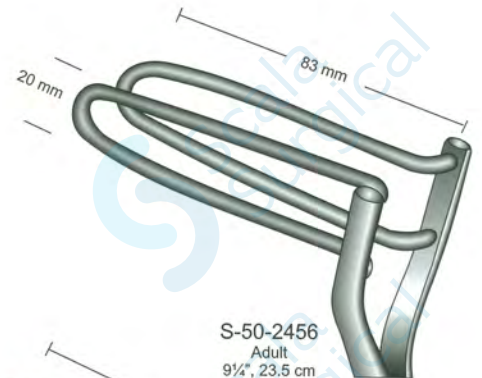
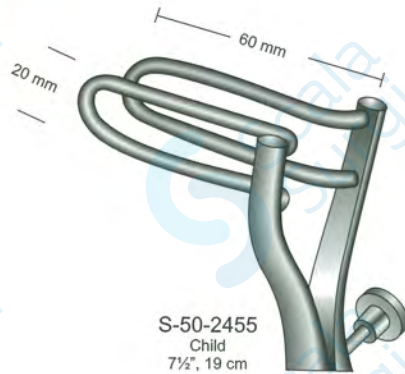
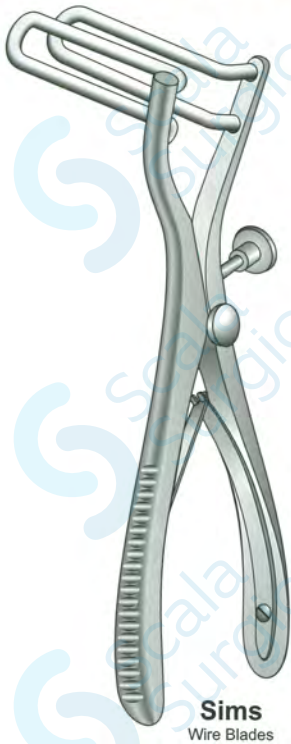

# Proctoscopes Accessories & Rectal Dilators



S-50-2545  
Battery Handle

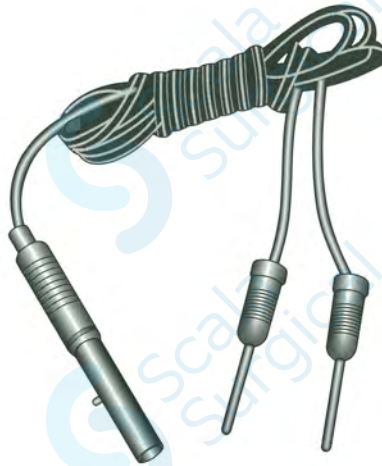

S-50-2546 Complete with Bulb  
S-50-2547 Bulb Only  
Light Attachment



**ST.Marks (Solid)**  
S-50-2549 Small, 14 x 19 mm  
S-50-2550 Large, 16 x 25 mm



Fig.1

Fig.2

Fig.3

Fig.4

### ST.Marks

- S-50-2552 Fig. 1, 16 mm
- S-50-2553 Fig. 2, 18 mm
- S-50-2554 Fig. 3, 23 mm
- S-50-2555 Fig. 4, 27 mm

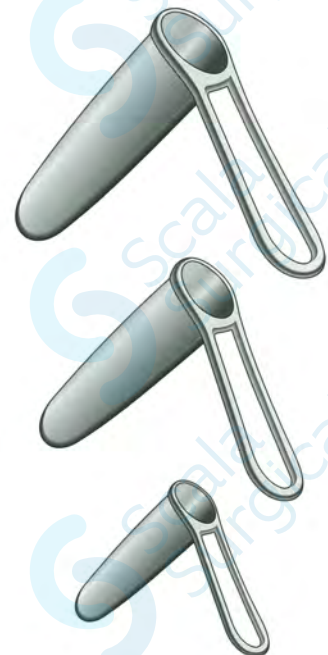

### Murphy

- S-50-2558 Small
- S-50-2559 Medium
- S-50-2560 Large



**Sigmoidoscopes**

S-50-2570

Complete Set with Child & Adult Tubes 1 Proctoscope  
Conventional Light Head



**Sigmoidoscopes Tubes**

S-50-2573 Child, 17 mm x 27 cm

S-50-2574 Adult, 20 mm x 30 cm

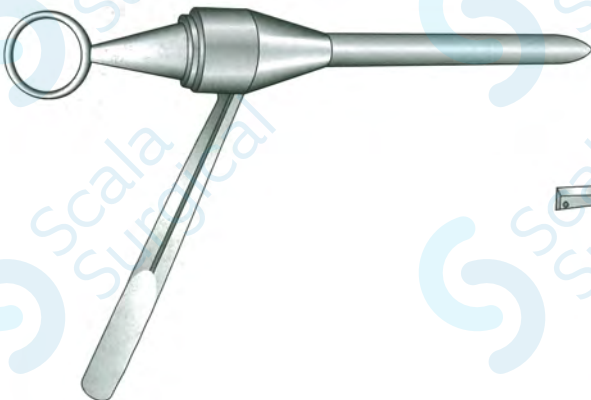

S-50-2576

75 mm Long  
9.5 mm Ø

Sigmoidoscope Tube Obturator

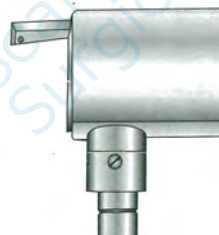

S-50-2578

Fibre Glass  
Light Chamber

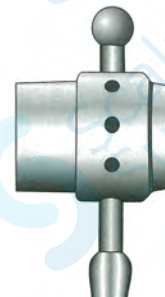

S-50-2579

Inflation Window

# Hemorrhoidal Forceps

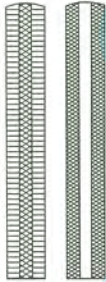
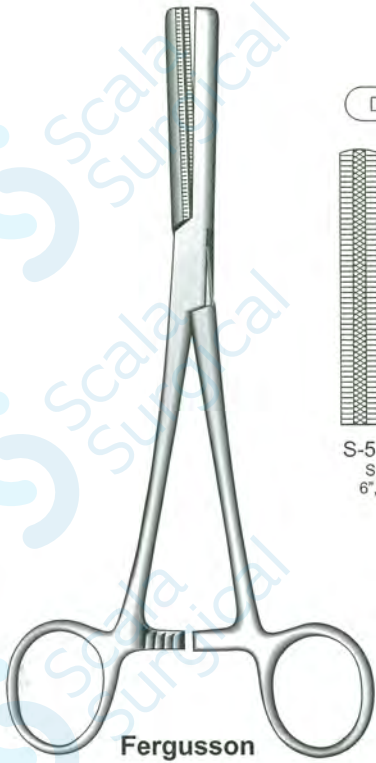

S-50-2580  
Straight  
6", 15 cm

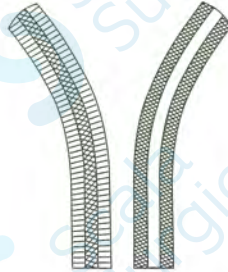

S-50-2581  
Curved  
6", 15 cm

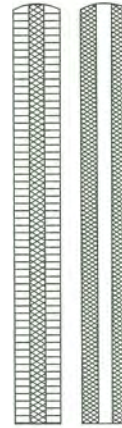

S-50-2582  
Straight  
8", 20 cm

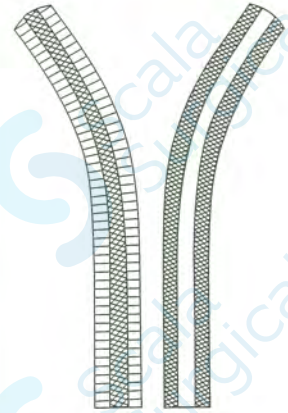

S-50-2583  
Curved  
8", 20 cm

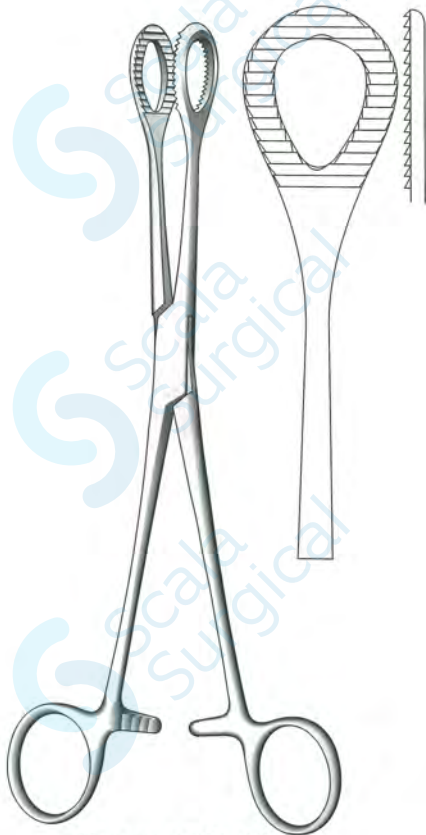

**Heywood-Smith**  
S-50-2585  
8", 20 cm  
Straight

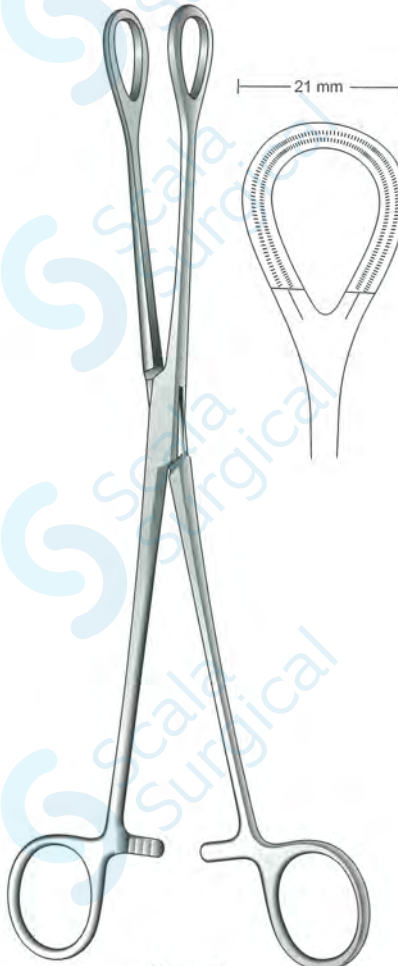

**Doyen**  
S-50-2586  
10", 25.5 cm

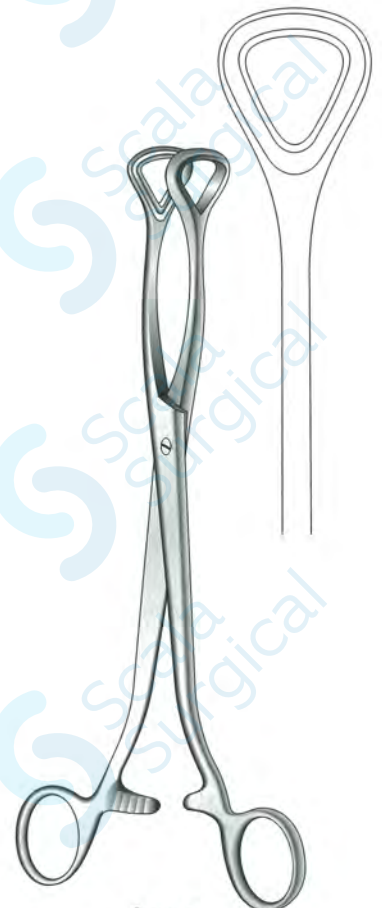

**Luer**  
S-50-2587 8 1/4", 21 cm  
S-50-2588 10 1/4", 26 cm

## Rectal Biopsy Forceps



**Lloyd Davis**  
S-50-2610  
35 mm Shaft  
Biopsy Forceps

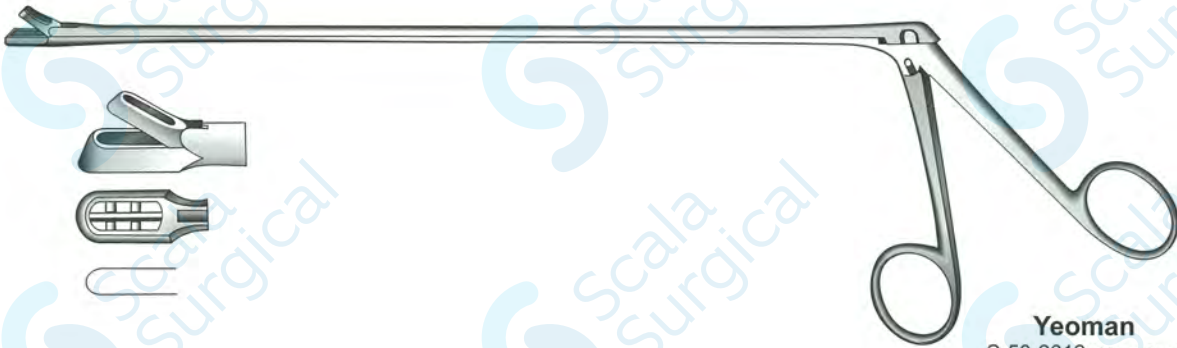

**Yeoman**  
S-50-2612 28 cm Shaft  
S-50-2613 35 cm Shaft  
S-50-2614 40 cm Shaft  
Biopsy Forceps



**Officer**  
S-50-2616  
43 cm Shaft  
8 mm Cup Jaws



# Biopsy Forceps

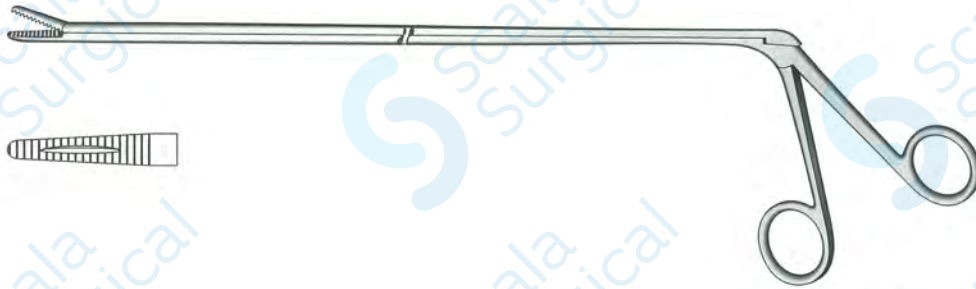

### Chevalier Jackson

- S-50-2618 28 mm
  - S-50-2619 35 mm
  - S-50-2620 40 mm
  - S-50-2621 45 mm
  - S-50-2622 50 mm
  - S-50-2623 60 mm
- Grasping Forceps

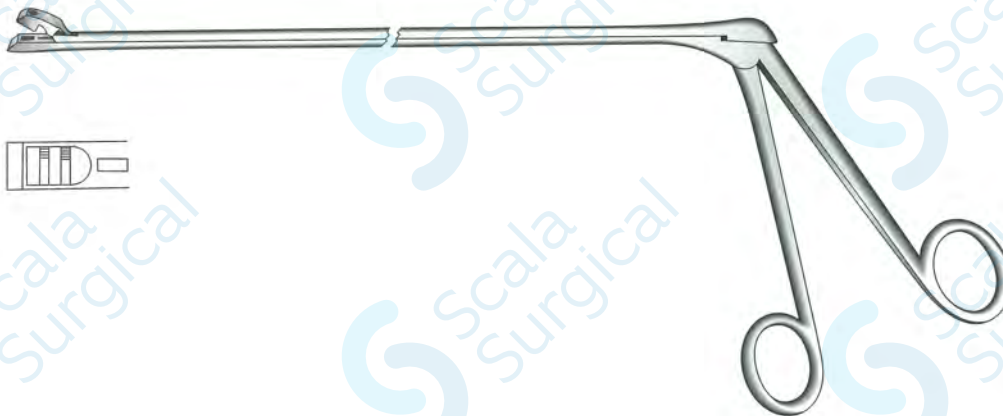

### Chevalier Jackson

- S-50-2626 28 mm
  - S-50-2627 35 mm
  - S-50-2628 40 mm
  - S-50-2629 45 mm
  - S-50-2630 50 mm
- Basket Jaw

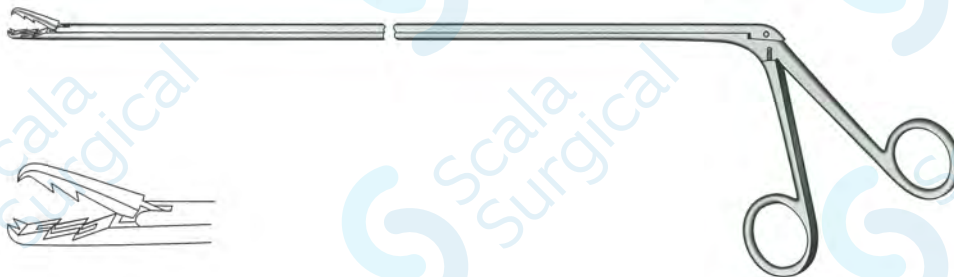

### Chevalier Jackson

- S-50-2633 35 mm
  - S-50-2634 40 mm
  - S-50-2635 45 mm
  - S-50-2636 50 mm
- Open Teeth

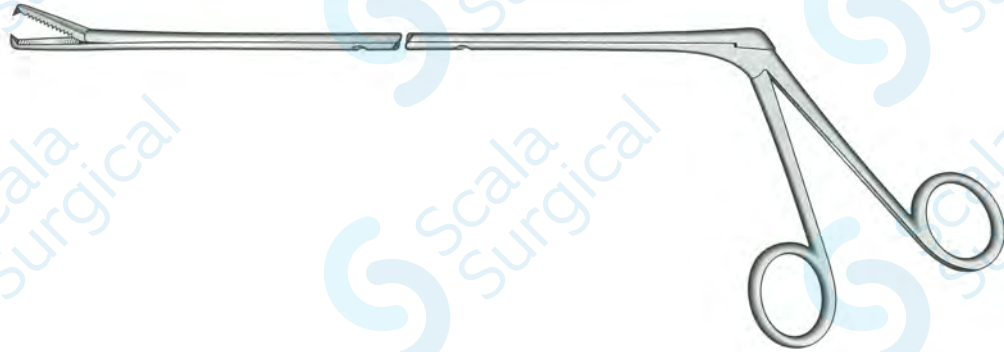

**Chevalier Jackson**

S-50-2638 28 cm  
S-50-2639 35 cm  
(Irwin Moore)  
1:2 Teeth

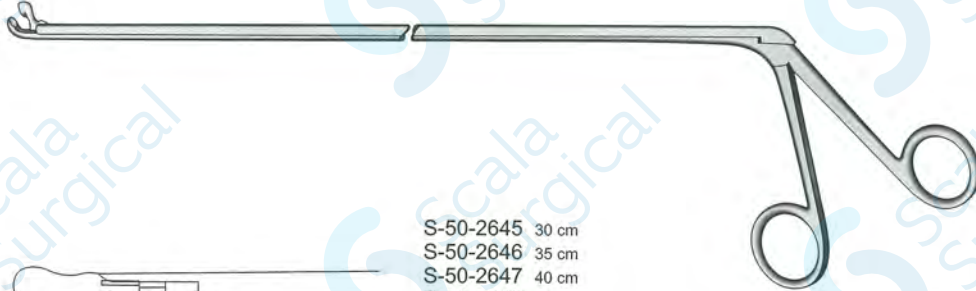

**Chevalier Jackson**

Nodule Forceps



Straight

- S-50-2645 30 cm
- S-50-2646 35 cm
- S-50-2647 40 cm
- S-50-2648 45 cm
- S-50-2649 50 cm
- S-50-2650 60 cm

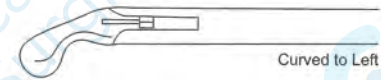

Curved to Left

- S-50-2655 30 cm
- S-50-2656 35 cm
- S-50-2657 40 cm
- S-50-2658 45 cm
- S-50-2659 50 cm
- S-50-2660 60 cm



Curved to Right

- S-50-2665 30 cm
- S-50-2666 35 cm
- S-50-2667 40 cm
- S-50-2668 45 cm
- S-50-2669 50 cm
- S-50-2670 60 cm



Curved to Upwards

- S-50-2675 30 cm
- S-50-2676 35 cm
- S-50-2677 40 cm
- S-50-2678 45 cm
- S-50-2679 50 cm
- S-50-2680 60 cm

# Biopsy Forceps



## Patterson

S-50-2685 30 cm  
S-50-2686 35 cm  
S-50-2687 40 cm  
S-50-2688 45 cm  
S-50-2689 50 cm  
S-50-2690 55 cm  
S-50-2691 60 cm  
Oval Jaws  
Biopsy Forceps

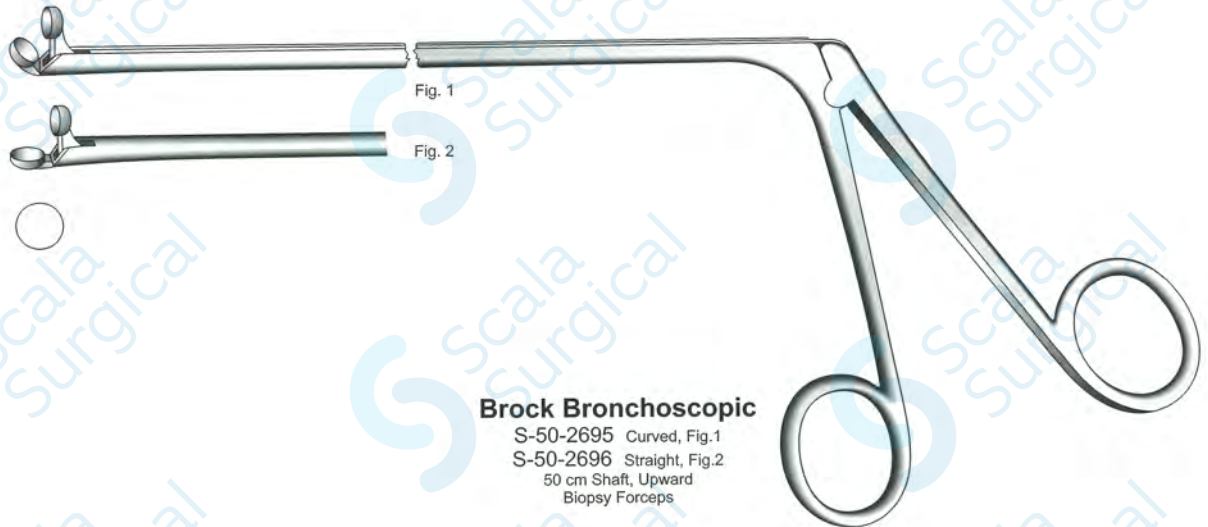
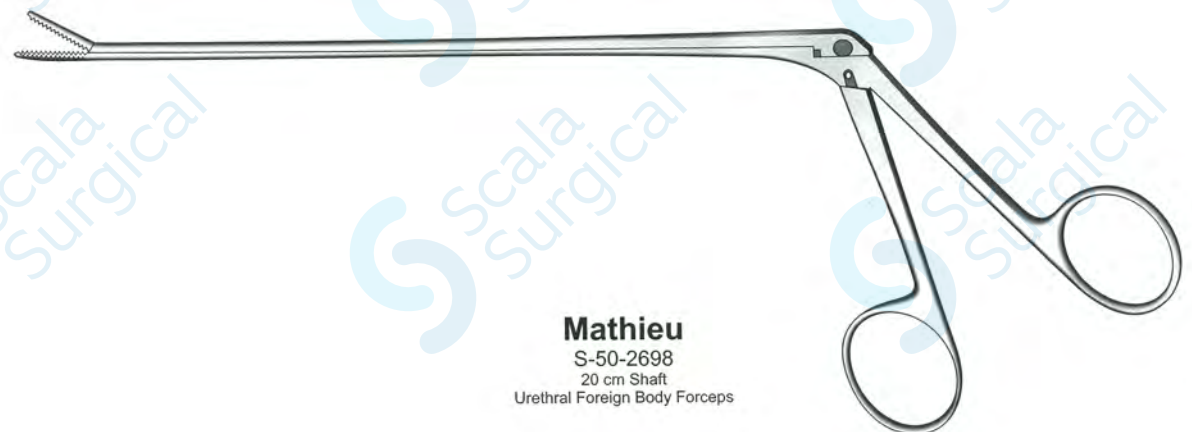

Fig. 1

Fig. 2

## Brock Bronchoscopic

S-50-2695 Curved, Fig.1  
S-50-2696 Straight, Fig.2  
50 cm Shaft, Upward  
Biopsy Forceps



## Mathieu

S-50-2698  
20 cm Shaft  
Urethral Foreign Body Forceps

**Hemorrhoidal Ligator &  
Seizing Forceps**



**McGivney**  
S-50-2700

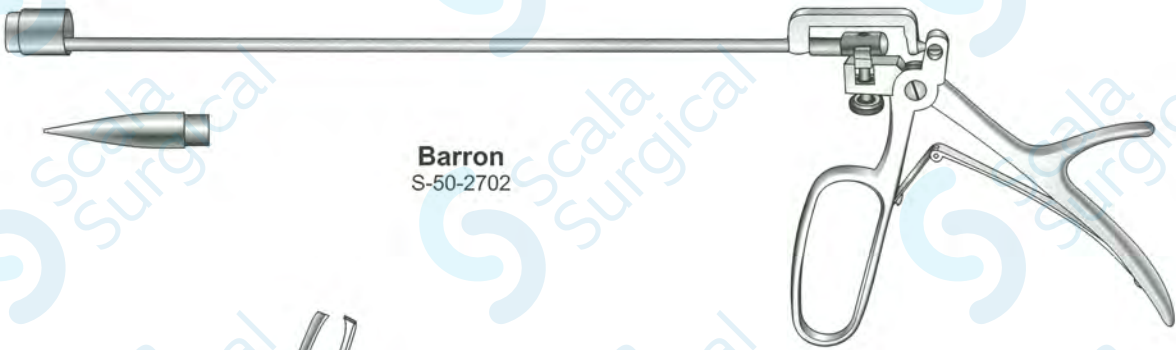

**Barron**  
S-50-2702



**St Georges Pattern**  
S-50-2704  
7½", 19 cm  
3:4 Teeth  
Seizing Forceps

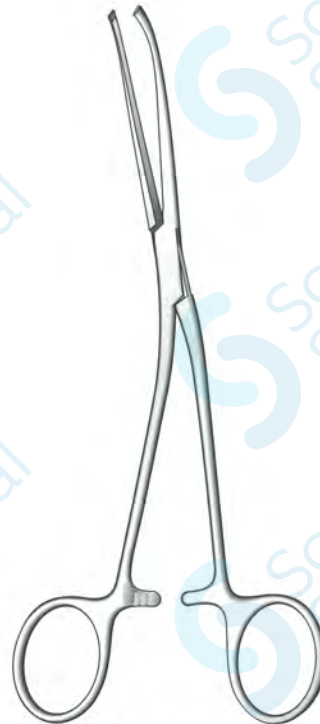

**Mc Givney**  
S-50-2706  
7¼", 18.5 cm

# Circumcision Instruments



**Thomson Walker**  
S-50-2710  
Penile Clamp

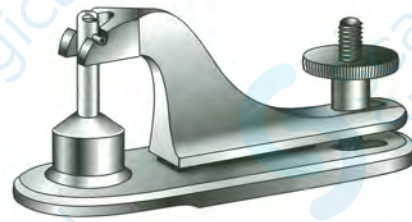

## Gumco Clamps

- S-50-2712 8 mm
- S-50-2713 11 mm
- S-50-2714 13 mm
- S-50-2715 16 mm
- S-50-2716 21 mm
- S-50-2717 26 mm
- S-50-2718 32 mm



S-50-2720  
Circumcision Shield  
with Lock

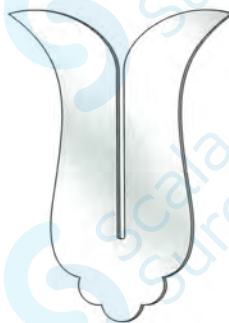

S-50-2722  
Circumcision Shield



## Collingwood Stewart

S-50-2730  
5½", 14 cm  
Hernia Forceps

**Vasectomy Instruments**

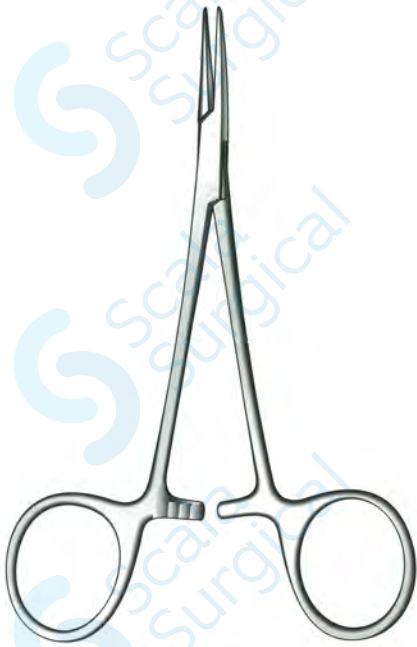

**S-50-2735**  
5", 13 cm  
Fine  
Vasectomy Forceps



**Soonawala**  
S-50-2737  
5½", 14 cm  
Vasectomy Forceps



**Tinckler**  
S-50-2739  
6", 15 cm  
Vasectomy Forceps

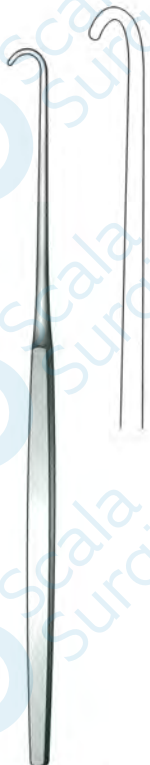

**S-50-2741**  
6½", 16.5 cm  
Hook For Spermatic Cord

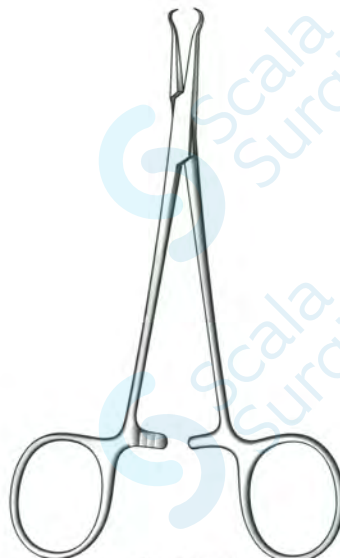

**S-50-2743**  
5", 12.5 cm  
Ring 4.8 mm Ø  
Forceps For Grasping  
The Glans & Foreskin

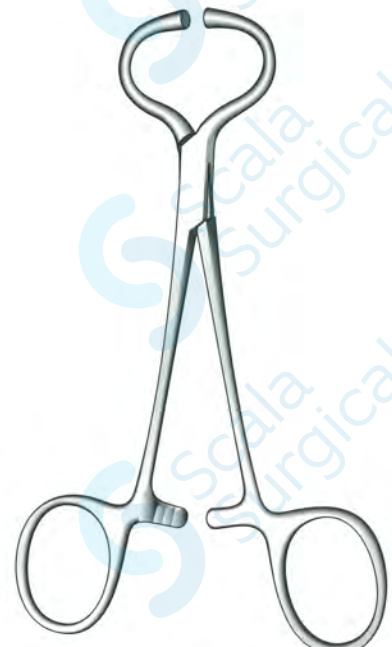

**S-50-2745**  
5¾", 14.5 cm  
Fixation Clamp For  
The Spermatic Cord

# Urethral Bougies



**Clutton**



**Clutton**

### Clutton

- S-50-2750 6/10 Fg.
- S-50-2751 8/12 Fg.
- S-50-2752 10/14 Fg.
- S-50-2753 12/16 Fg.
- S-50-2754 14/18 Fg.
- S-50-2755 16/20 Fg.
- S-50-2756 18/22 Fg.
- S-50-2757 20/24 Fg.
- S-50-2758 22/26 Fg.
- S-50-2759 24/28 Fg.
- S-50-2760 26/30 Fg.
- S-50-2761 28/32 Fg.

S-50-2765 Set of 12  
10 1/2", Long  
Urethral Bougies



**Lister**

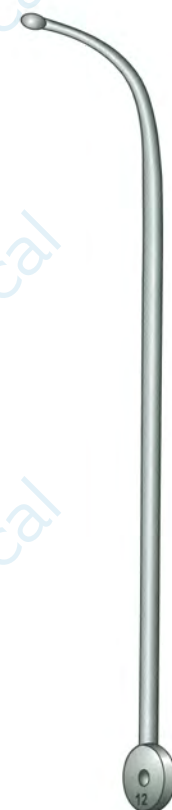

**Lister**

### Lister Urethral

- S-50-2770 0/2 Eg.
- S-50-2771 1 Eg.
- S-50-2772 1/3 Eg.
- S-50-2773 1/4 Eg.
- S-50-2774 2/5 Eg.
- S-50-2775 3/6 Eg.
- S-50-2776 4/7 Eg.
- S-50-2777 5/8 Eg.
- S-50-2778 6/9 Eg.
- S-50-2779 7/10 Eg.
- S-50-2780 8/11 Eg.
- S-50-2781 9/12 Eg.

S-50-2783 Set Of 12  
11", Long  
Bougies

### Lister Urethral

- S-50-2784 10/13 Eg.
- S-50-2785 11/14 Eg.
- S-50-2786 12/15 Eg.
- S-50-2787 13/16 Eg.
- S-50-2788 14/17 Eg.
- S-50-2789 15/18 Eg.

Olive End  
Extra Large



**Dittel**

- S-50-2790 8 Fg.
  - S-50-2791 9 Fg.
  - S-50-2792 10 Fg.
  - S-50-2793 11 Fg.
  - S-50-2794 12 Fg.
  - S-50-2795 13 Fg.
  - S-50-2796 14 Fg.
  - S-50-2797 15 Fg.
  - S-50-2798 16 Fg.
  - S-50-2799 17 Fg.
  - S-50-2800 18 Fg.
  - S-50-2801 19 Fg.
  - S-50-2802 20 Fg.
  - S-50-2803 21 Fg.
  - S-50-2804 22 Fg.
  - S-50-2805 23 Fg.
  - S-50-2806 24 Fg.
  - S-50-2807 25 Fg.
  - S-50-2808 26 Fg.
  - S-50-2809 27 Fg.
  - S-50-2810 28 Fg.
  - S-50-2811 29 Fg.
  - S-50-2812 30 Fg.
- Bougies



**Hey Grove**

- S-50-2815 4/7 Eg.
  - S-50-2816 6/9 Eg.
  - S-50-2817 8/11 Eg.
- S-50-2819 Set of 3  
6 3/4", 17 cm  
Retrograde Bougies



# Urethral Bougies



### Turner Warwick

- S-50-2823 4/5 - 7/12 Fg.
- S-50-2824 10/15 - 13/18 Fg.
- S-50-2825 16/21 - 19/24 Fg.
- S-50-2826 22/27 - 25/30 Fg.
- S-50-2827 28/33 - 31/36 Fg.

S-50-2829 Set of 5  
Retrograde Mattel Dilators



### Turner Warwick

S-50-2830  
4/9 - 7/12 Fg.  
6 1/4", 16 cm  
Double End



### Turner Warwick

S-50-2831  
10/15 - 13/18 Fg.  
6 1/4", 16 cm  
Double End



### Turner Warwick

S-50-2832  
16/21 - 19/24 Fg.  
6 1/4", 16 cm  
Double End



### Turner Warwick

S-50-2833  
22/27 - 25/30 Fg.  
6 1/4", 16 cm  
Double End



### Turner Warwick

S-50-2834  
28/33 - 31/36 Fg.  
6 1/4", 16 cm  
Double End

### Turner Warwick

S-50-2835  
Set of 5  
6 1/4", 16 cm  
Double End



**Wyndham Powell**

- S-50-2840 10 Fg.
- S-50-2841 11 Fg.
- S-50-2842 12 Fg.
- S-50-2843 13 Fg.
- S-50-2844 14 Fg.
- S-50-2845 15 Fg.
- S-50-2846 16 Fg.
- S-50-2847 17 Fg.
- S-50-2848 18 Fg.
- S-50-2849 19 Fg.
- S-50-2850 20 Fg.
- S-50-2851 21 Fg.
- S-50-2852 22 Fg.
- S-50-2853 23 Fg.
- S-50-2854 24 Fg.
- S-50-2855 25 Fg.
- S-50-2856 26 Fg.
- S-50-2857 27 Fg.
- S-50-2858 28 Fg.
- S-50-2859 29 Fg.
- S-50-2860 30 Fg.
- S-50-2861 31 Fg.
- S-50-2862 32 Fg.



S-50-2863 Set of 21  
12 Fg. – 32 Fg.  
6 3/4", 17 cm  
Bougies



S-50-2865  
Bladder Sound



**Thomson Walker**  
S-50-2868  
8 oz  
Bladder Syringe

# Gall Stone Scoops / Probes / Dilators

Diameter of tip 5 mm



**Moynihan**  
S-50-2870  
Scoop & Probe

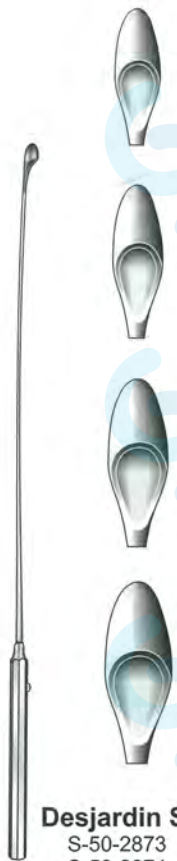

**Desjardin Scoop**  
S-50-2873 17 Fg.  
S-50-2874 21 Fg.  
S-50-2875 24 Fg.  
S-50-2876 27 Fg.

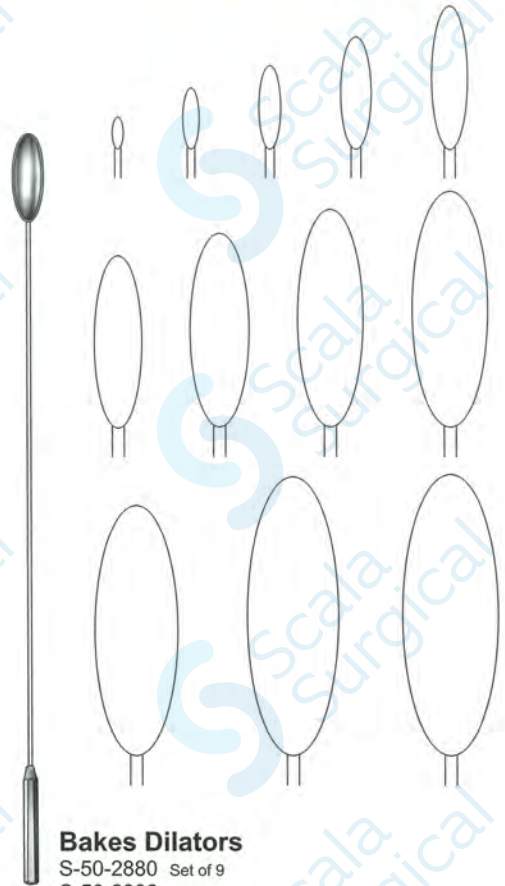

**Bakes Dilators**  
S-50-2880 Set of 9  
S-50-2882 Set of 13  
Malleable Shaft 200 mm



**Foley**  
S-50-2885  
455 mm  
Curved  
Catheter Introducer



**Foley**  
Straight  
S-50-2887  
455 mm  
S-50-2888  
510 mm, 2 mm Tip  
Catheter Introducer



**Foley**  
S-50-2890 2 mm Tip  
S-50-2892 4 mm Tip  
430 mm, Curved  
Catheter Introducer



**Foley**  
S-50-2894  
2 mm Tip  
with Guyon Curved  
510 mm, 2 mm  
Catheter Introducer



**Mayo**  
S-50-2900  
Tip 5 mm Ø



**Rotunda Hospital**  
S-50-2935 8 Eg.  
S-50-2936 10 Eg.

- S-50-2910 6 Eg.
  - S-50-2912 7 Eg.
  - S-50-2914 8 Eg.
  - S-50-2916 9 Eg.
  - S-50-2918 10 Eg.
  - S-50-2920 12 Eg.
- Female



**Coxter**  
S-50-2938



S-50-2925  
Male



**Mercier**  
S-50-2940

# Rectal Excision Clamp

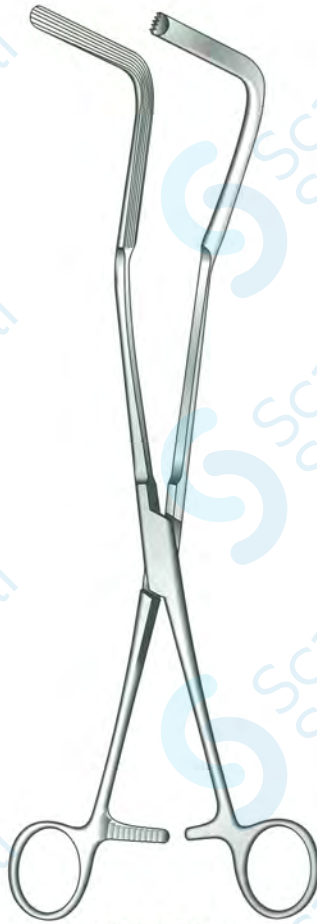

**Lloyd Davis**  
S-50-2944  
12", 30.5 cm



**Finch**  
S-50-2945  
9", 23 cm



**Houghiton**  
S-50-2946  
10", 25.5 cm



**Teals Gorget**  
S-50-2948

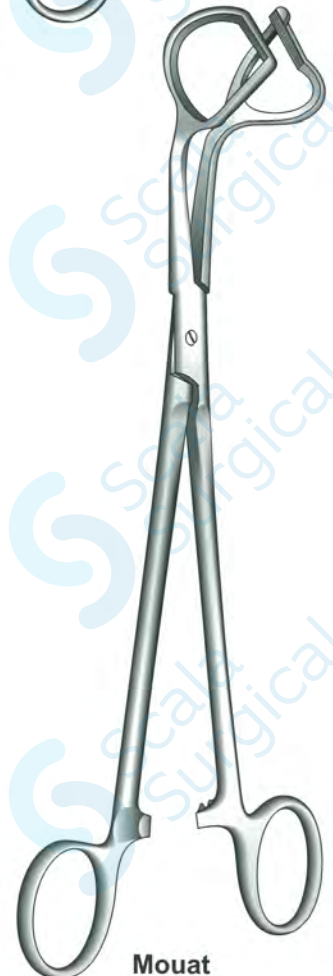

**Mouat**  
S-50-2949  
8½", 22 cm  
Gall Bladder Forceps

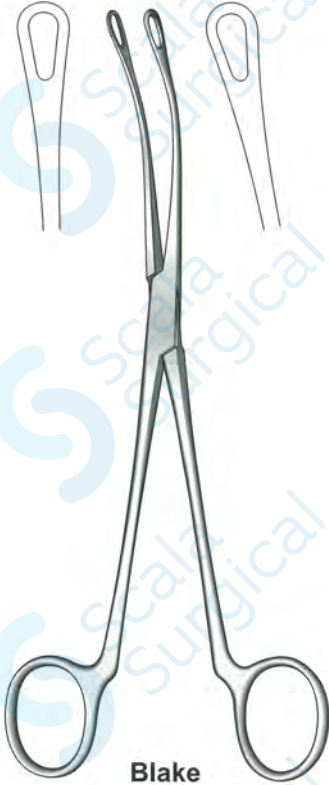

**Blake**  
S-50-2950 Straight  
S-50-2952 Curved  
8", 20 cm



**Randall**



S-50-2954  
8½", 22 cm  
¼ Curved



S-50-2956  
9", 23 cm  
¼ Curved



S-50-2958  
8½", 21 cm  
Full Curved

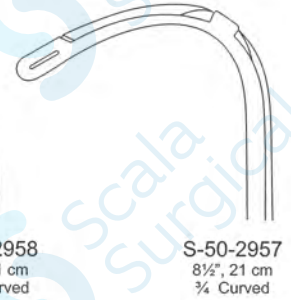

S-50-2957  
8½", 21 cm  
¾ Curved

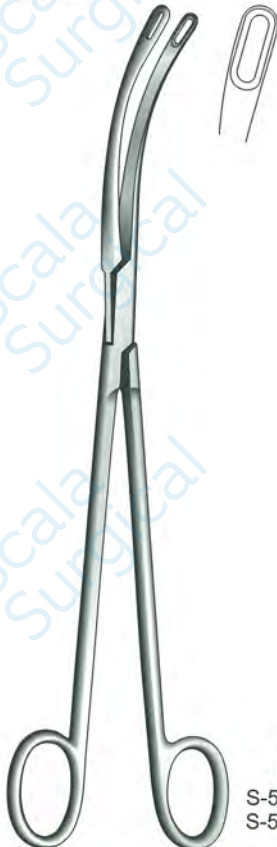

**Desjardin**  
S-50-2960 Small Jaw  
S-50-2961 Large Jaw  
8¾", 22 cm

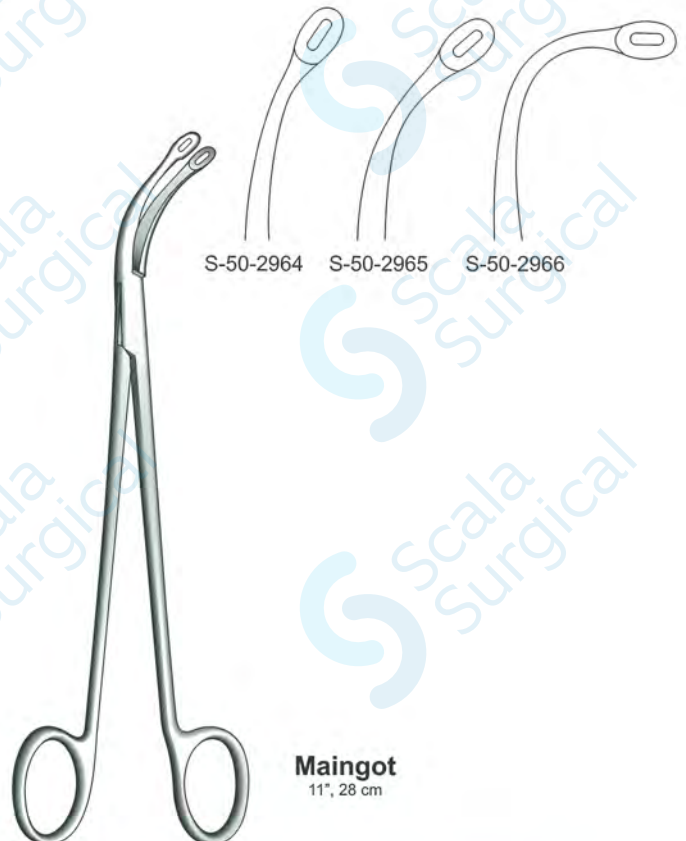

**Maingot**  
11", 28 cm

# Gall Duct & Kidney Pedicle Clamp Forceps

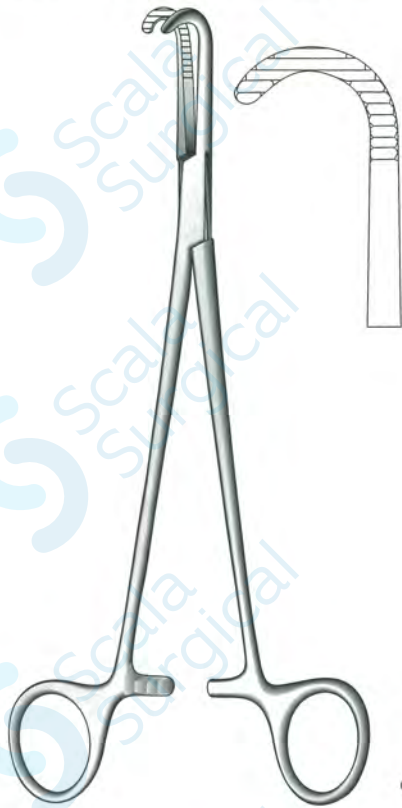

**Desjardins**  
S-50-2968  
8 3/4", 22 cm  
Gall Duct & Cystic Forceps



**Thomson Walker**  
S-50-2972  
8", 20 cm  
Kidney Pedicle Clamp

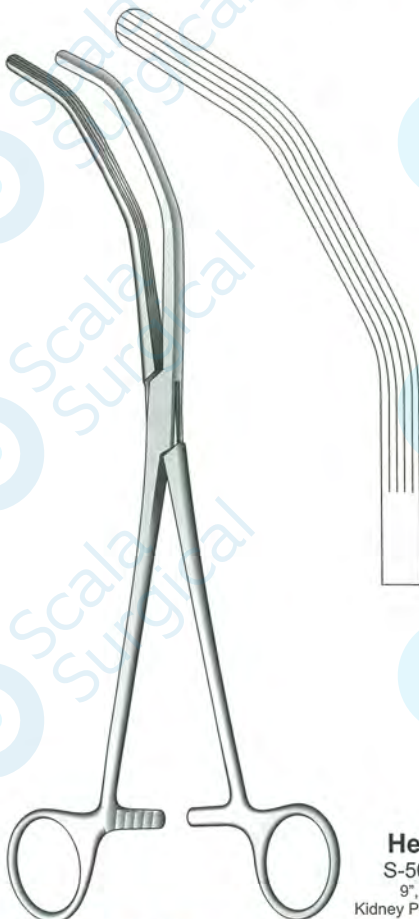

**Herrick**  
S-50-2974  
9", 23 cm  
Kidney Pedicle Clamp



**Mayo (Guyon)**  
S-50-2976 Shallow Curve  
S-50-2977 Deep Curve  
9", 23 cm

## Peritoneal Forceps

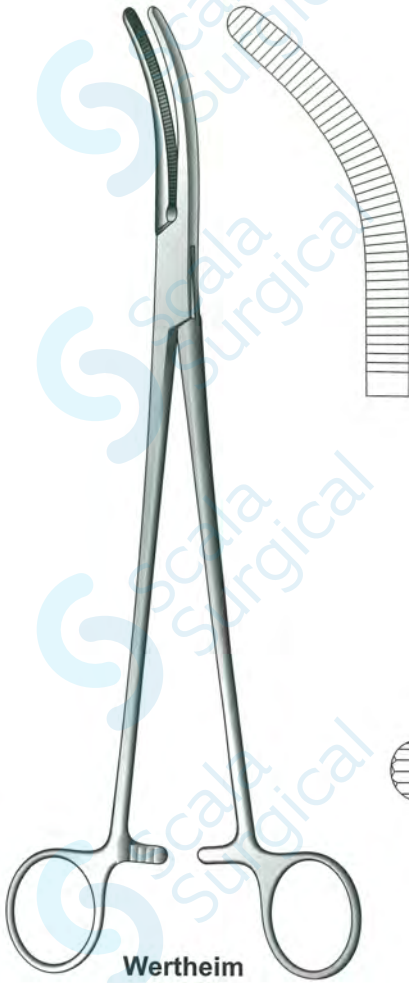

**Wertheim**  
S-50-2980  
10", 25.5 cm



**Wertheim**  
S-50-2984  
10", 25.5 cm

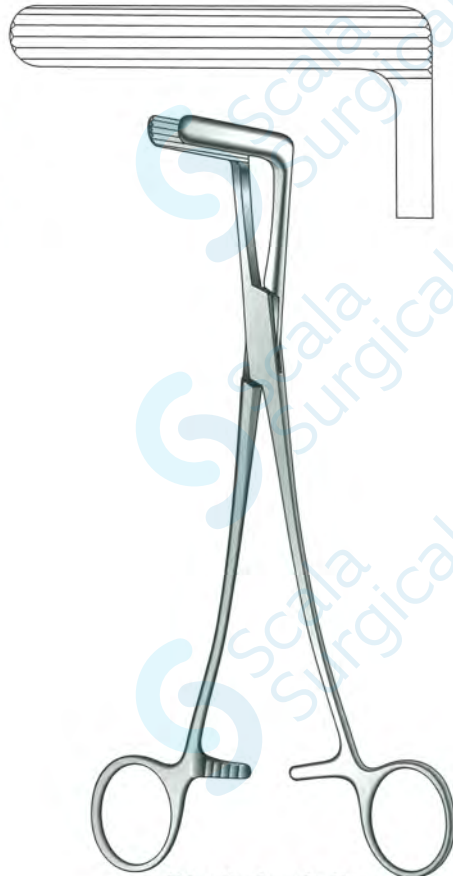

**Wertheim Cullen**  
S-50-2982  
8½", 21.5 Cm



# Urology Instruments



**Millin Capsular**  
S-50-3000  
T Shaped Jaws



**Millin Vulsellum**  
S-50-3002  
8:9 Teeth

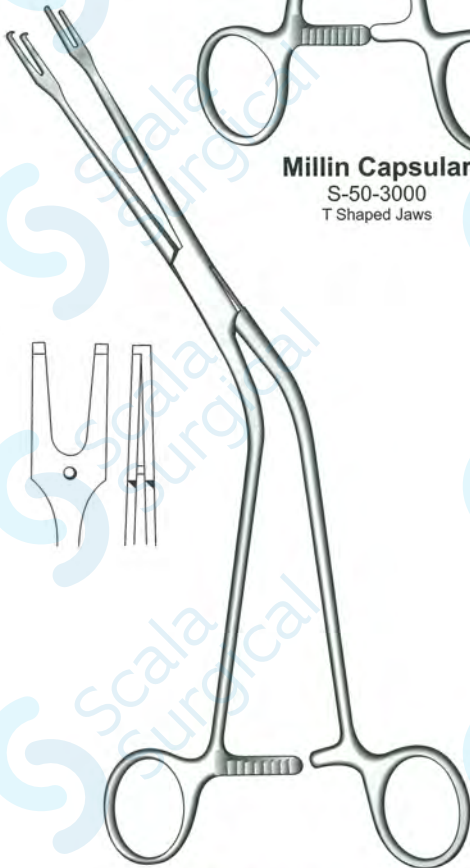

**Millin Ligature**  
S-50-3004  
Holding Forceps

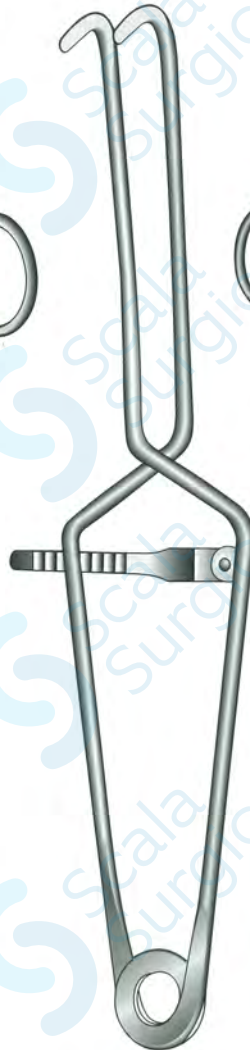

**Millin**  
S-50-3008  
Bladder Neck Spreader  
With Ratchet

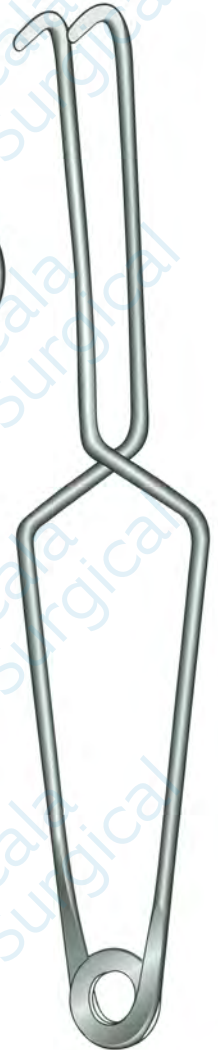

**Millin**  
S-50-3009  
Bladder Neck Spreader  
Without Ratchet



**Millin Bladder**

S-50-3012

Central Blade, 110 mm Deep, 45 mm Wide  
2 Lateral Blades, 80 mm Deep, 25 mm Wide  
Retractor

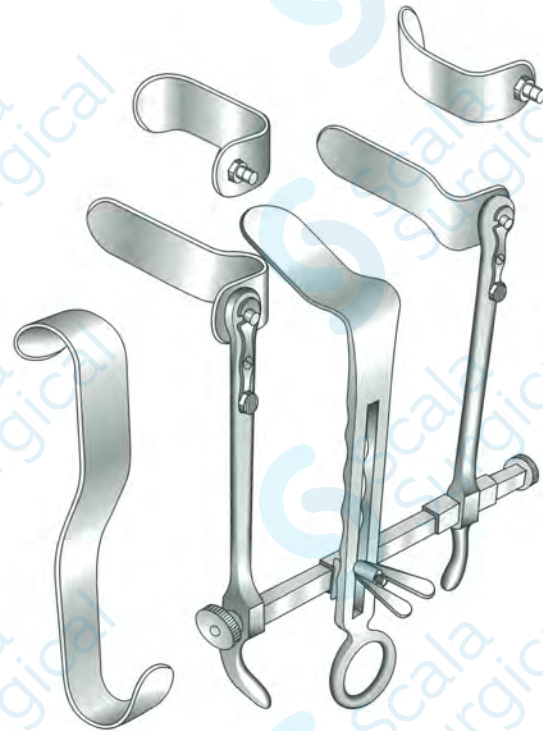

**Thomson Walker Bladder**

S-50-3014

One Posterior Blade 95 mm x 30 mm  
One Anterior Blade 175 mm x 25 mm  
One Pair of Lateral Swivel Blade  
Shallow 55 mm x 22 mm  
Deep 75 mm x 25 mm  
Retractor

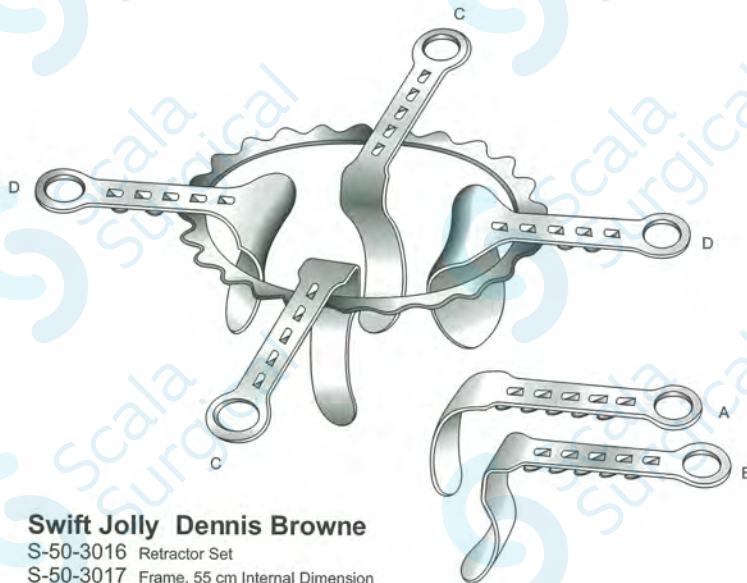

**Swift Jolly Dennis Browne**

S-50-3016 Retractor Set

S-50-3017 Frame, 55 cm Internal Dimension

S-50-3018 Blade A, 50 mm Deep, 25 mm Wide

S-50-3019 Blade B, 70 mm Deep, 25 mm Wide

S-50-3020 Blade C, 90 mm Deep, 25 mm Wide

S-50-3021 Blade D, 65 mm Deep, 67 mm Wide  
Retractor