

Vulsellum & Tenaculum Forceps

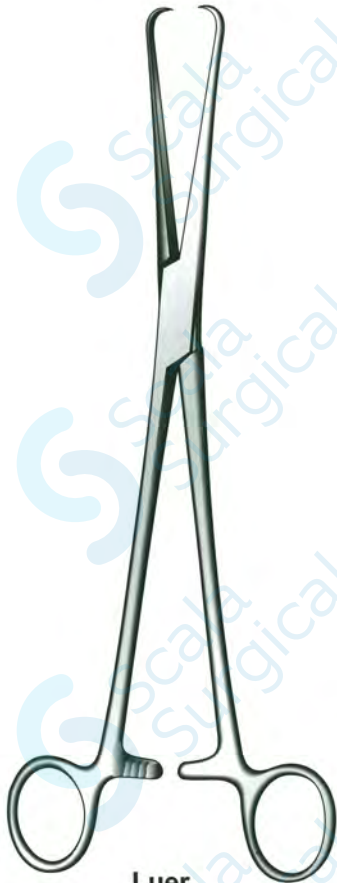

Luer
S-52-2500 Screw Joint
S-52-2501 Box Joint
9½", 24 cm



Braun (Pozzi)
S-52-2505
10", 25.5 cm



Rotunda
S-52-2507
10½", 26.5 cm



Duplay
S-52-2509
10", 25.5 cm

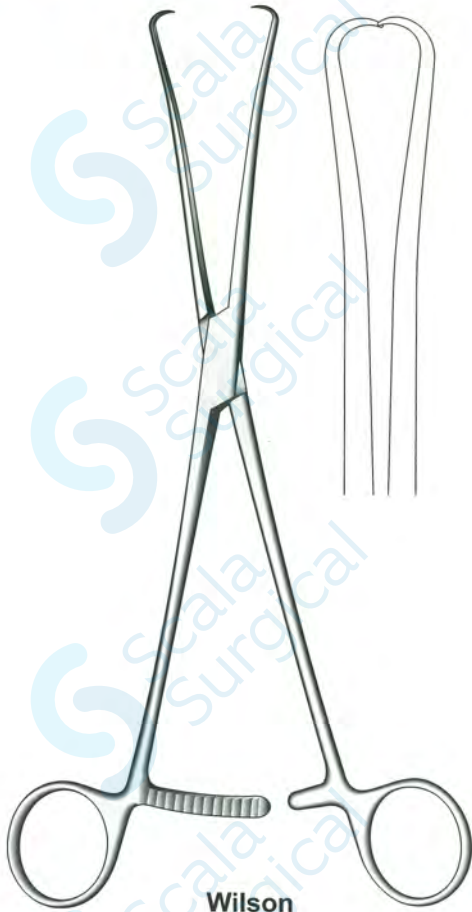

Wilson
S-52-2511
9½", 24 cm

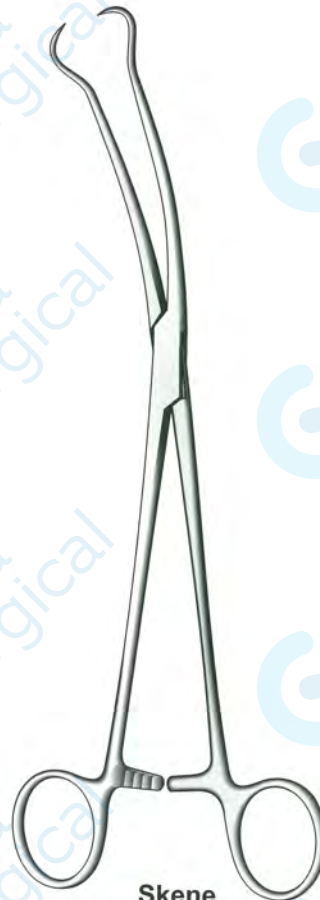

Skene
S-52-2513
9", 23 cm

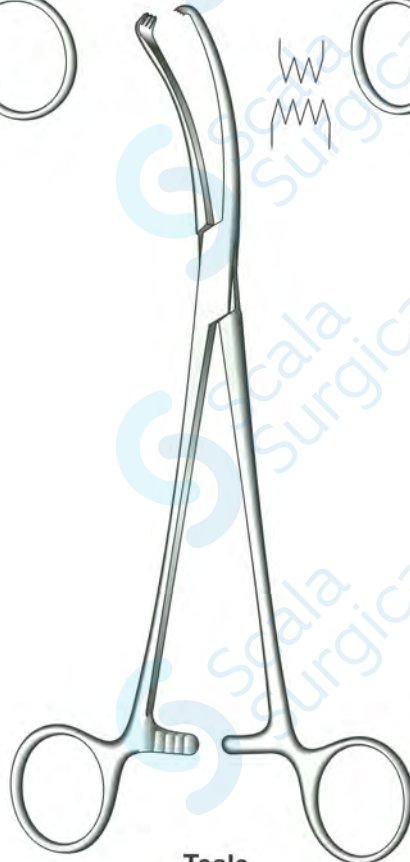

Teale
S-52-2515 7", 18 cm
S-52-2516 9", 23 cm
3:4 Teeth

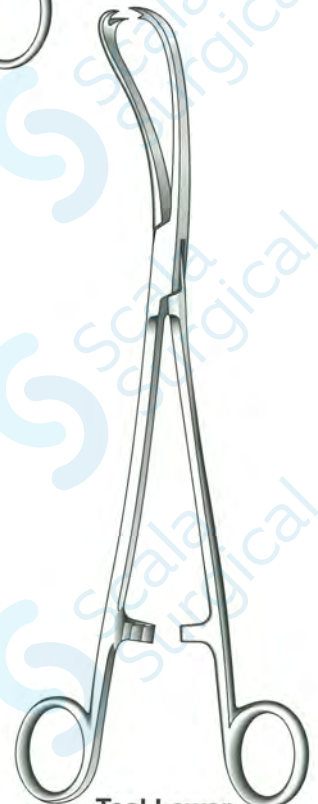

Teal Lever
S-52-2519 Screw Joint
S-52-2520 Box Joint
9", 23 cm
2:2 Teeth

Gynecological

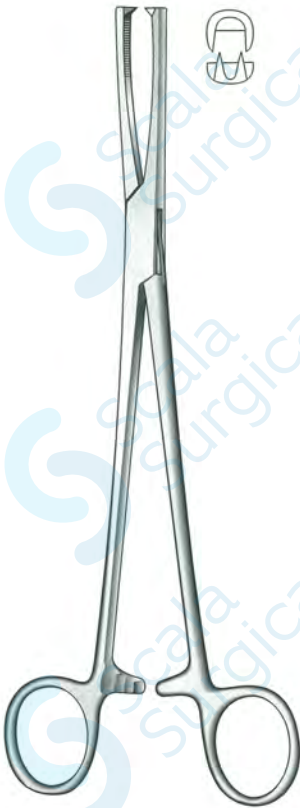

Jacobs
 S-52-2522 Straight
 S-52-2523 Curved
 8¼", 21 cm
 2:2 Teeth

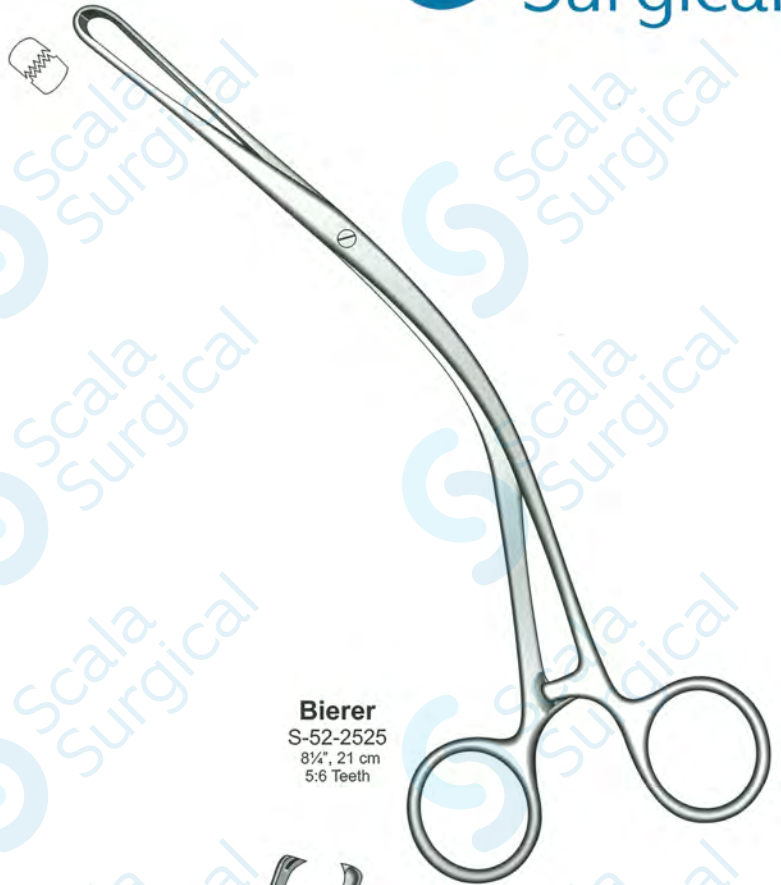

Bierer
 S-52-2525
 8¼", 21 cm
 5:6 Teeth

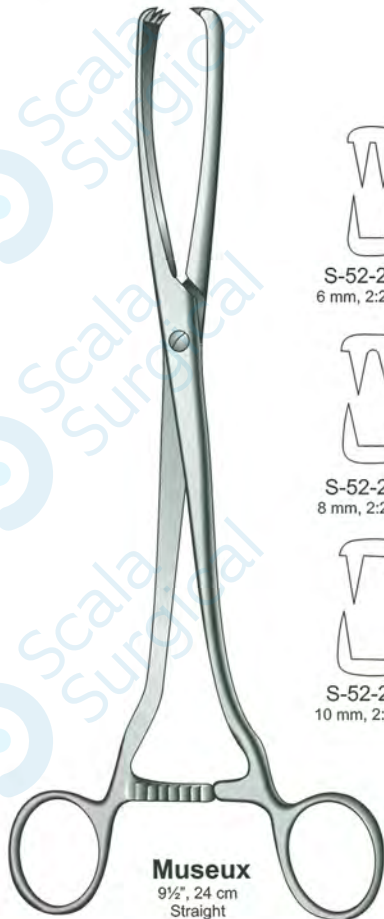

Museux
 9½", 24 cm
 Straight

S-52-2527
 6 mm, 2:2 Teeth

S-52-2528
 8 mm, 2:2 Teeth

S-52-2529
 10 mm, 2:2 Teeth

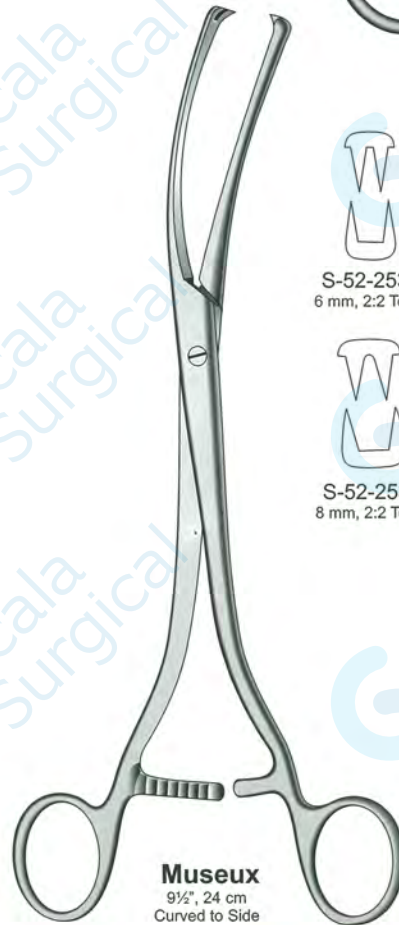

Museux
 9½", 24 cm
 Curved to Side

S-52-2531
 6 mm, 2:2 Teeth

S-52-2532
 8 mm, 2:2 Teeth

10 mm



S-52-2540
Straight

S-52-2542
Curved on Flat

S-52-2544
Curved to Side

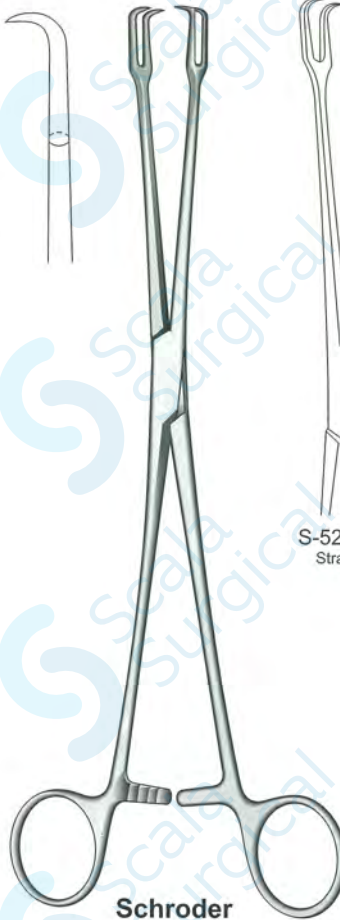

Schroder
10", 25.5 cm



S-52-2535
8 mm, 3:3 Teeth

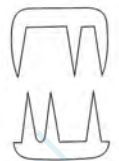

S-52-2536
12 mm, 3:3 Teeth

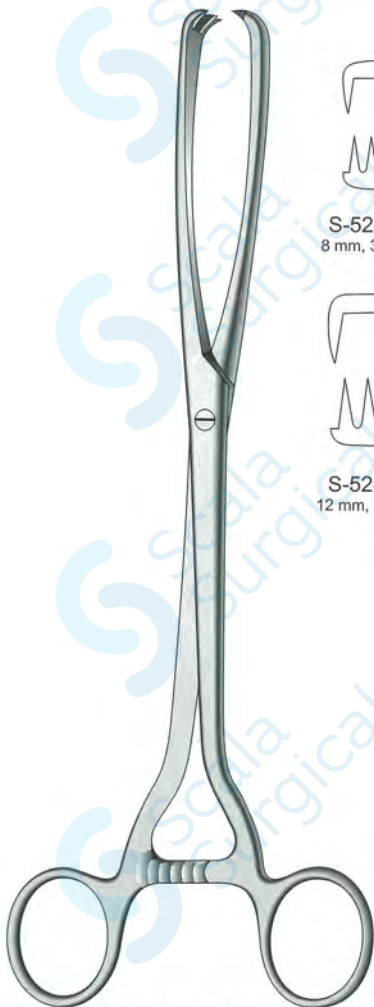

Museux
10½", 26.5 cm
Straight

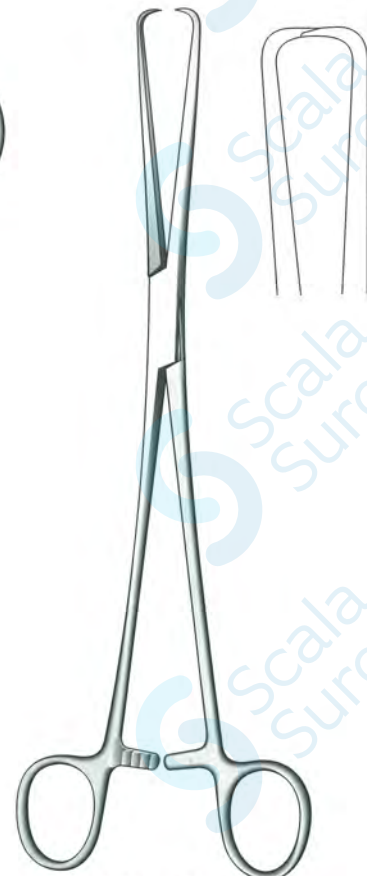

Schroder
S-52-2538
10", 25.5 cm



Lahey
S-52-2546
6", 15 cm
2:2 Teeth

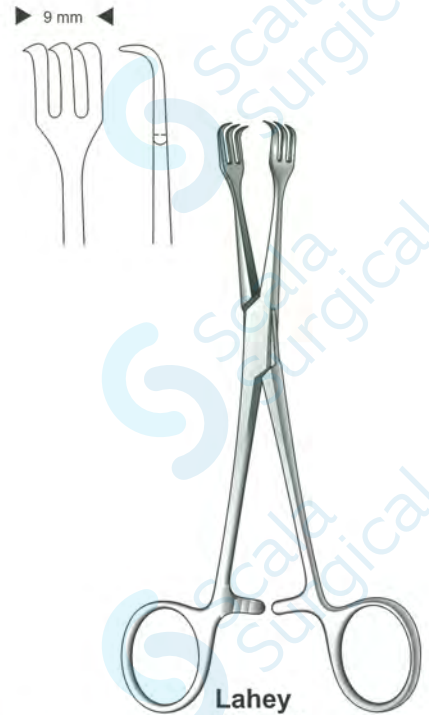

Lahey
S-52-2548
6", 15 cm
3:3 Teeth

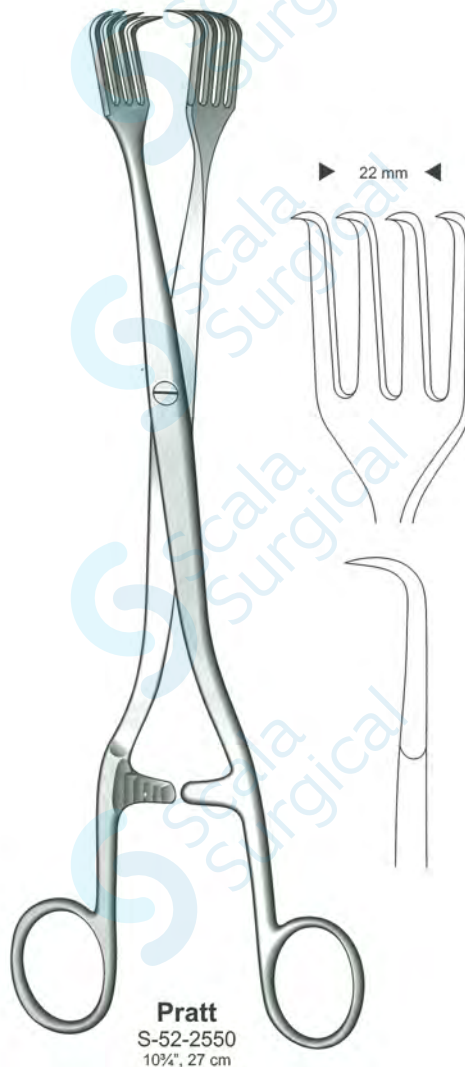

Pratt
S-52-2550
10 1/4", 27 cm

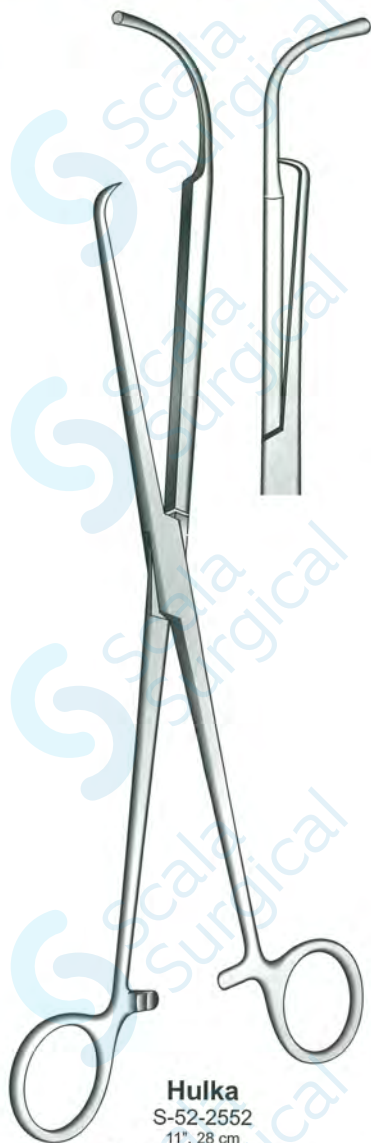

Hulka
S-52-2552
11", 28 cm
Tenaculum with Malleable
Uterine Sound

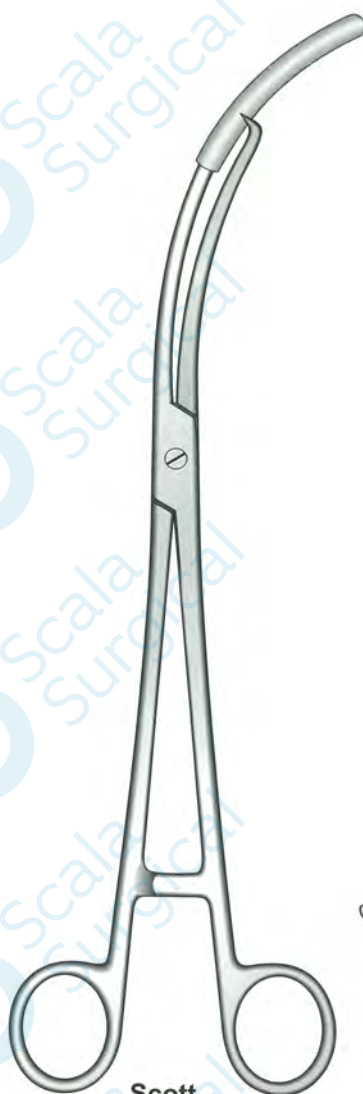

Scott
S-52-2554
11", 28 cm
Uterine Manipulator



Green Armytage
S-52-2556
8 1/4", 21 cm
Straight

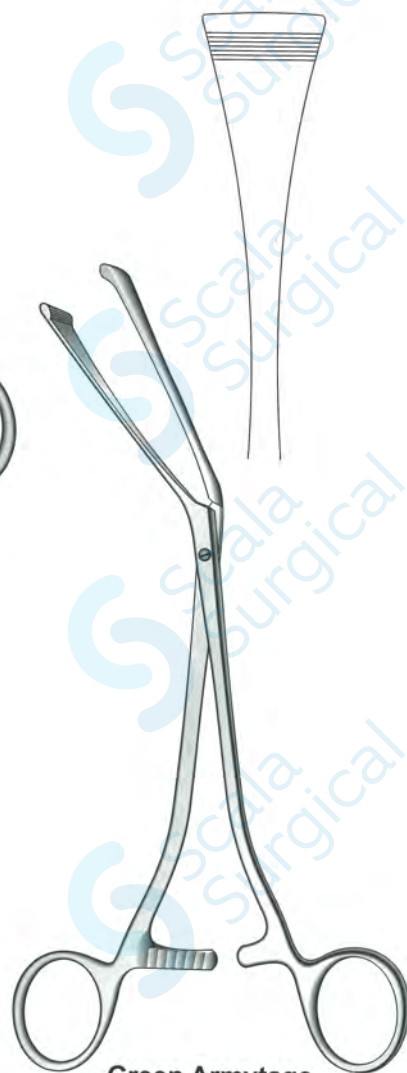

Green Armytage
S-52-2558
8 1/4", 21 cm
Angled

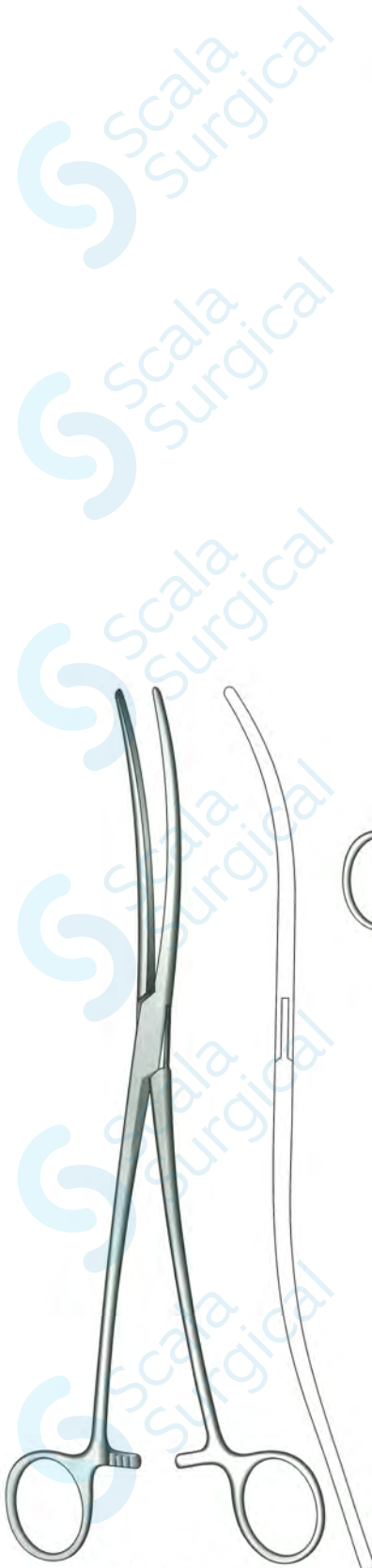

Bozemmann

S-52-2566 Serrated Jaws
S-52-2568 Grooved Jaws
10", 25.5 cm



Pelkmann

S-52-2560 Straight
S-52-2562 Curved
10 1/4", 26 cm

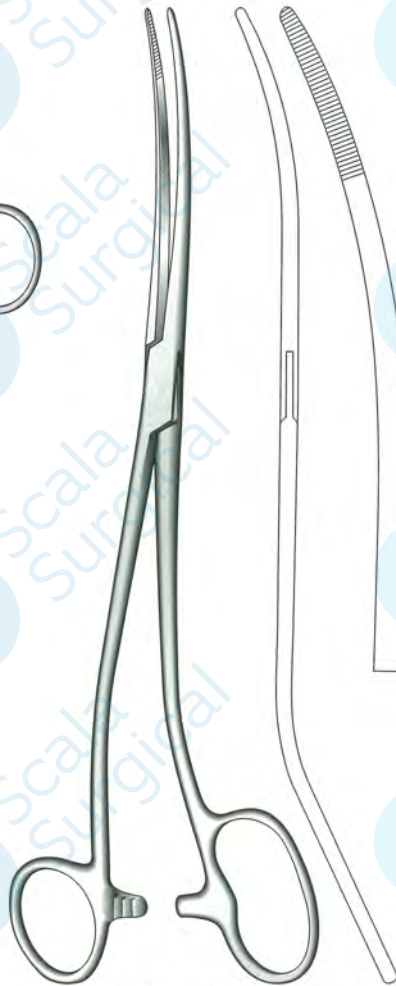

Bozemmann Douglas

S-52-2570
10 1/4", 26 cm

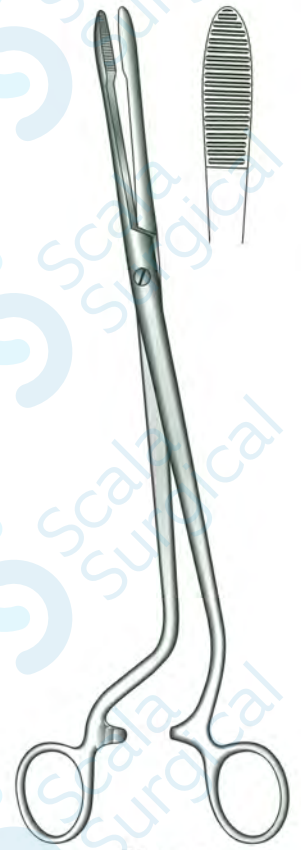

Cheron

S-52-2564
10", 25.5 cm

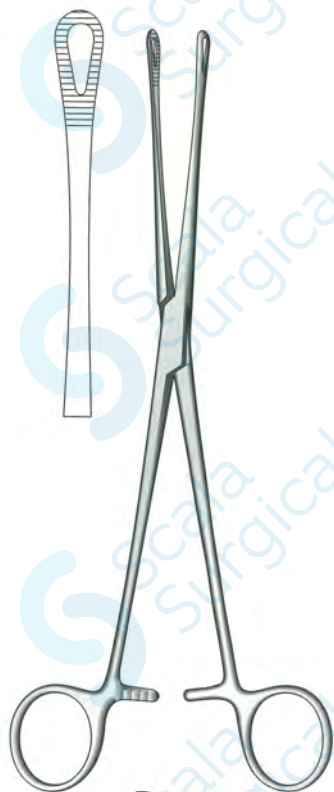

Bonney
S-52-2590
9½", 24 cm

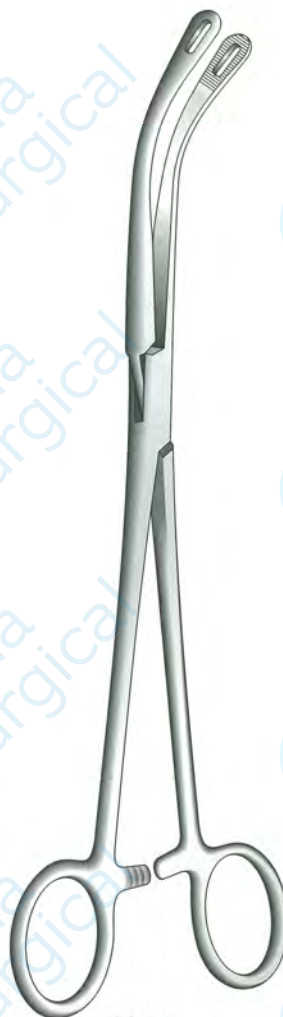

Vant
S-52-2592
10½", 26.5 cm



Noto
S-52-2594
10½" 26.5 cm

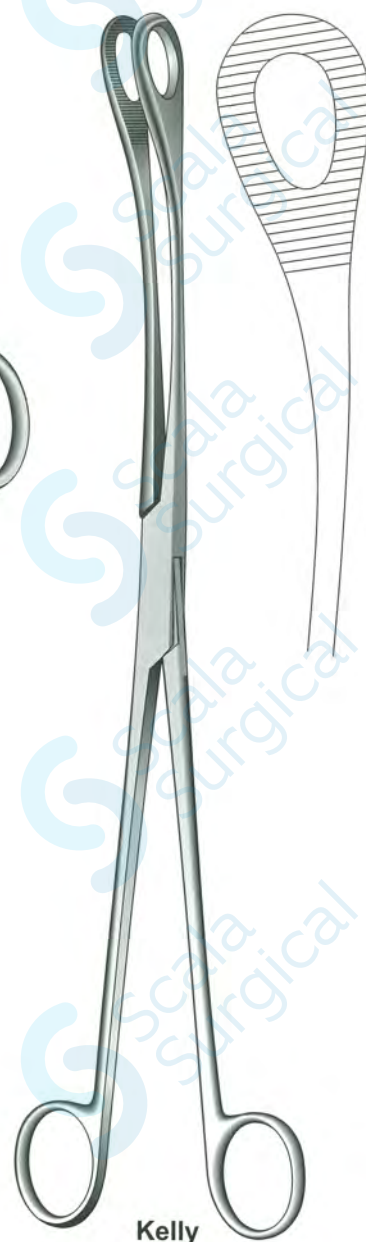

Kelly
S-52-2596
12½", 32 cm

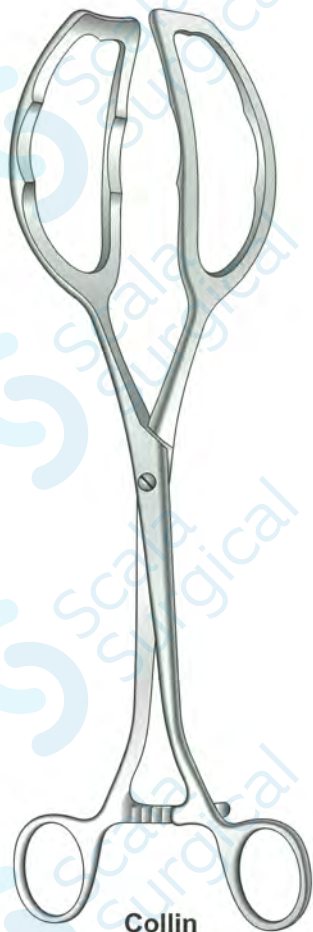

Collin
S-52-2600
11¼", 28.5 cm

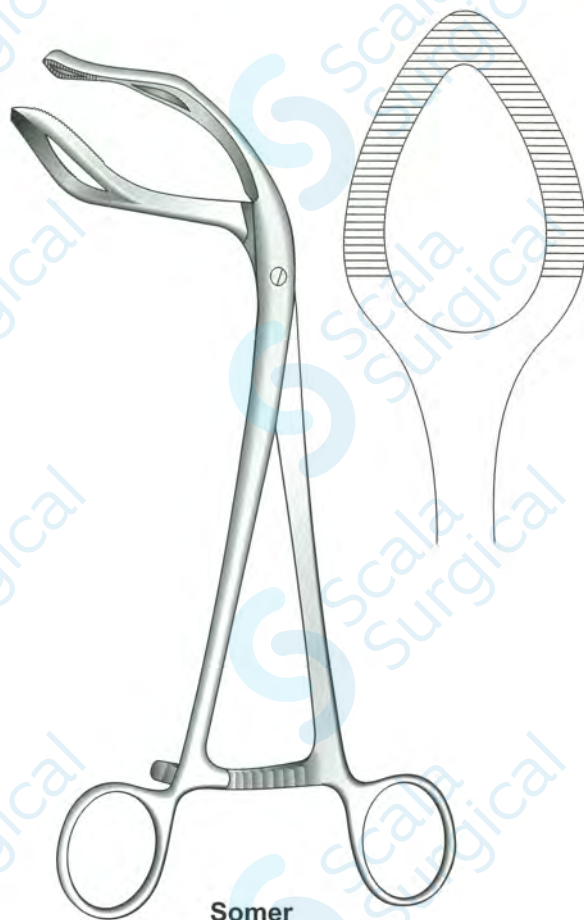

Sommer
S-52-2602
9¼", 23.5 cm

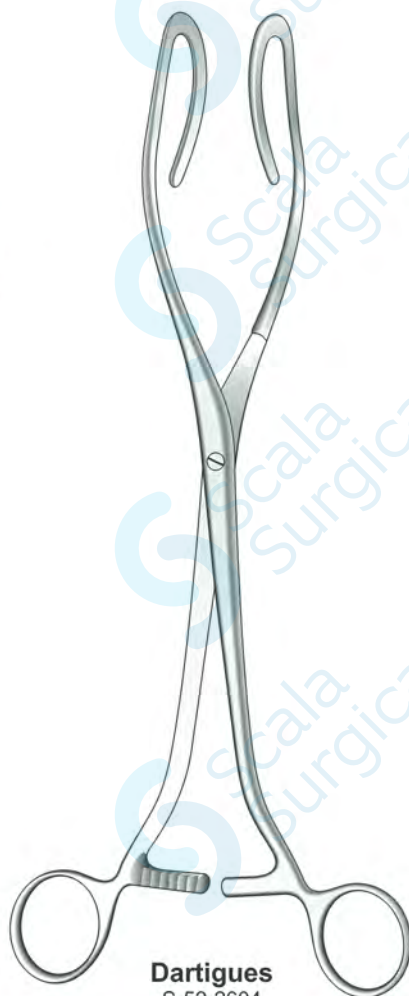

Dartigues
S-52-2604
10", 25.5 cm



Bierer
S-52-2606
11", 28 cm

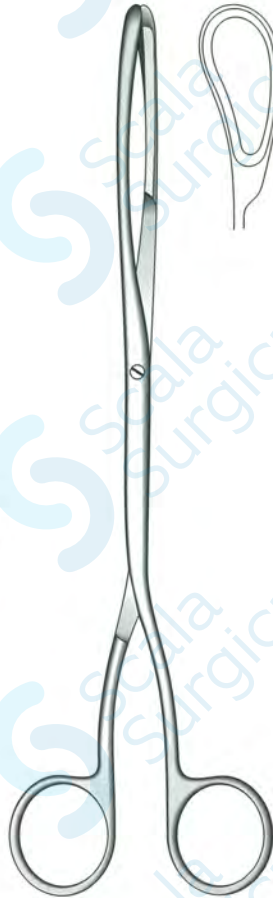

Greenhalgh
S-52-2608
9½", 24 cm

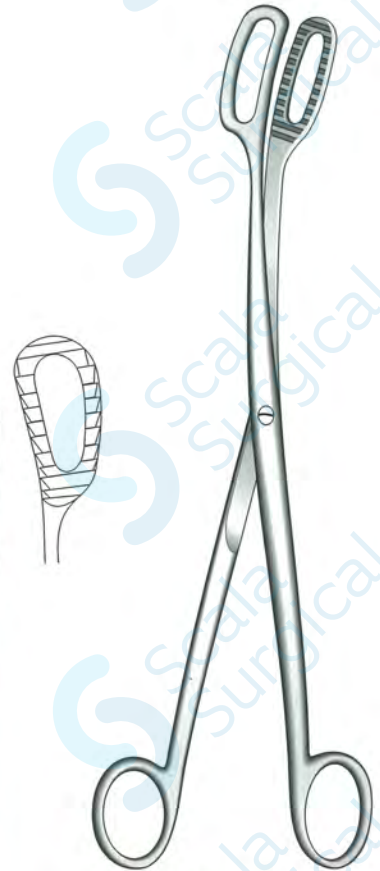

Mc Cann
S-52-2610
9½", 24 cm

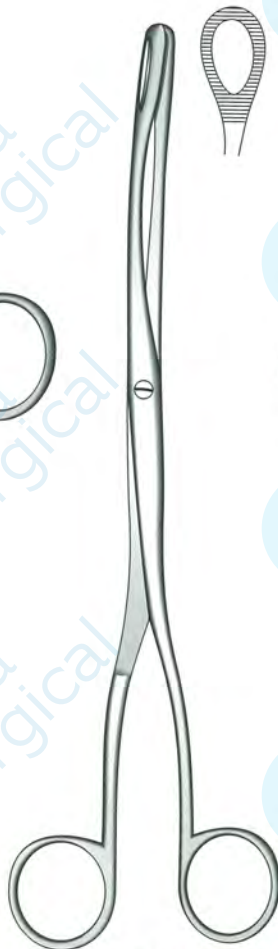

McClintock
S-52-2612
9½", 24 cm



Sopher
S-52-2614
11", 28 cm

Gynecological

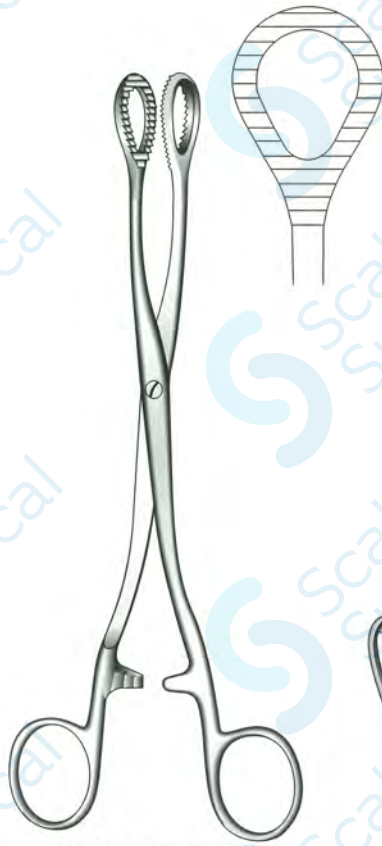

Heywood-Smith
S-52-2616
8", 20 cm

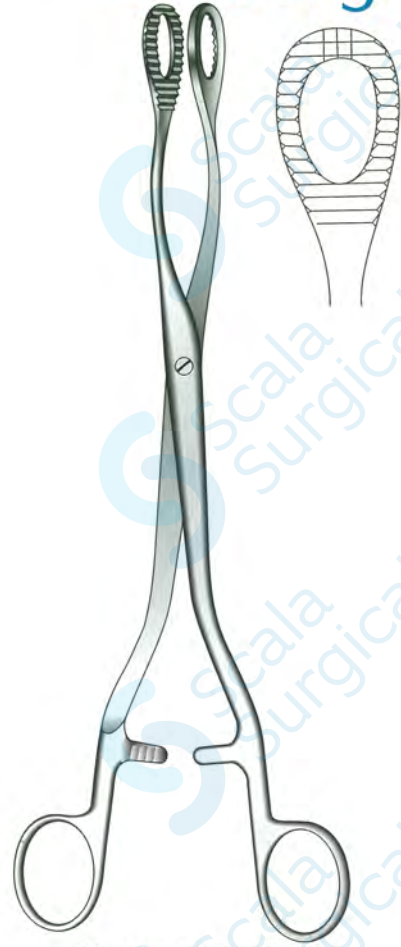

Heywood-Smith
S-52-2618
10", 25.5 cm

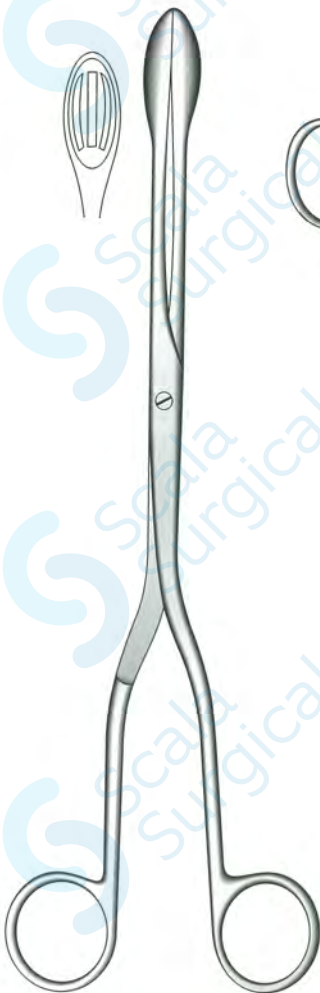

Heywood-Smith
S-52-2620
10", 25.5 cm

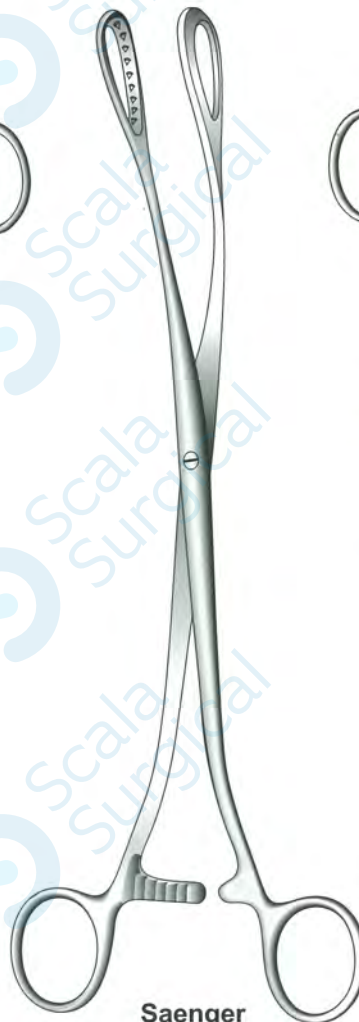

Saenger
11", 28 cm



S-52-2622
Straight

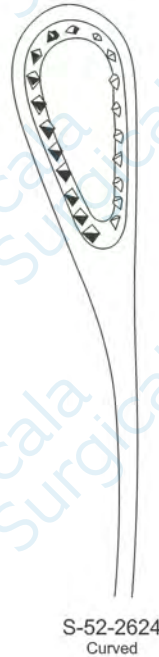

S-52-2624
Curved



Winter
11½", 29 cm
Straight

S-52-2628
Fig. 1



S-52-2629
Fig. 2



Winter
11½", 29 cm
Curved

S-52-2631
Fig. 1

S-52-2632
Fig. 2

S-52-2633
Fig. 3



Doyen
S-52-2640
For Abdominal use
150 mm



Doyen
S-52-2642
For Vaginal use
175 mm

Gynecological



Goodwin Amniotomy
S-52-2645
10 1/4", 26 cm



Gelder Amniotomy
S-52-2647
9 1/2", 24 cm



Bonney
S-52-2649
13 1/2", 34.3 cm
Vaginal Forceps

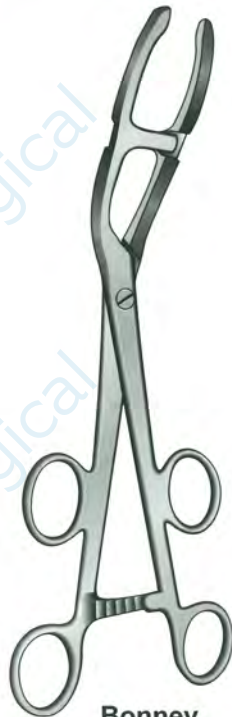

Bonney
S-52-2651
Myomectomy Clamp

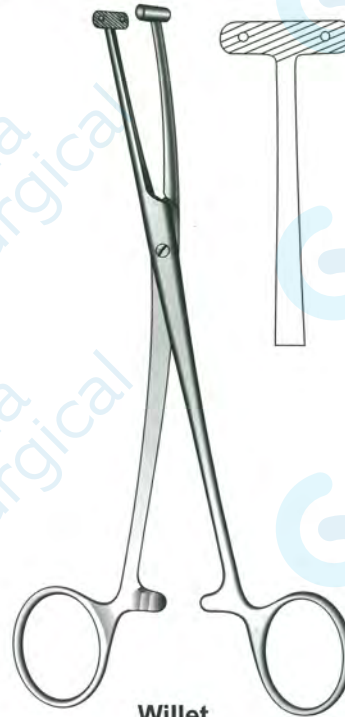

Willet
S-52-2653 7 1/2", 18.5 cm
S-52-2655 10", 25.5 cm



Schroder
12 $\frac{3}{4}$ ", 31 cm



S-52-2660
6.8 mm
Fig.1



S-52-2661
8.5 mm
Fig.2



S-52-2662
10 mm
Fig.3



S-52-2663
11.5 mm
Fig.4



S-52-2664
13 mm
Fig.5



S-52-2665
14.5 mm
Fig.6



Simon
10", 25.5 cm



S-52-2670
6.8 mm
Fig.1



S-52-2671
8.5 mm
Fig.2



S-52-2672
10 mm
Fig.3



S-52-2673
11 mm
Fig.4



S-52-2674
13 mm
Fig.5



S-52-2675
14.5 mm
Fig.6

Uterine Hooks



Emmet
S-52-2680
9", 23 cm
Single Hook



Emmet
S-52-2681
9", 23 cm
Double Hook



Emmet
S-52-2682
9", 23 cm
Triple Hook



Hamilton Fore - Water
S-52-2685
12", 30.5 cm
Amniotomy Hook



IUCD
S-52-2687
10", 25.5 cm
Removing Hook

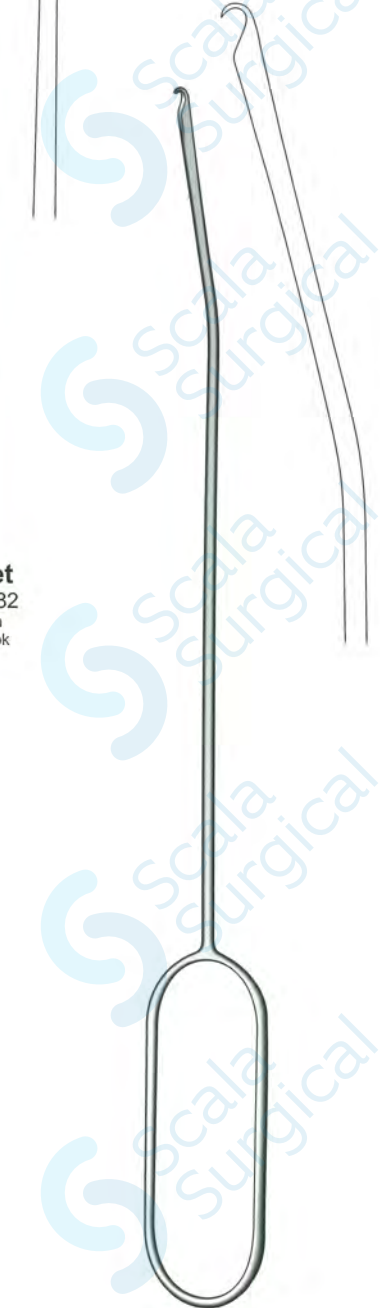

Saunders
S-52-2689
12½", 32 cm
IUCD Removing Hook

Uterine Sound & Depressors



Galabin
S-52-2691



Horrocks
S-52-2692



Martin
S-52-2693



Sims
S-52-2694



Simpson
S-52-2695



Sims
S-52-2698
10 1/4", 26 cm



Braun
S-52-2699
11", 28 cm



Gervis
S-52-2700
9 1/2", 24 cm

Gynecological



Randall
S-52-2702
9½", 24 cm
Biopsy Curette



Novak
S-52-2704
9", 23 cm
Biopsy Curette

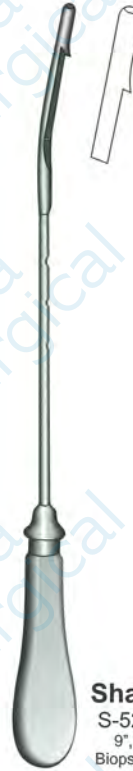

Sharman
S-52-2706
9", 23 cm
Biopsy Curette



Bierer
S-52-2710 8 mm
S-52-2711 10 mm
S-52-2712 12 mm
S-52-2713 14 mm
S-52-2714 16 mm
Suction Tubes



Kevorkian Younger
S-52-2716 9½", 24 cm
S-52-2717 12", 30.5 cm
Endometrial Curette

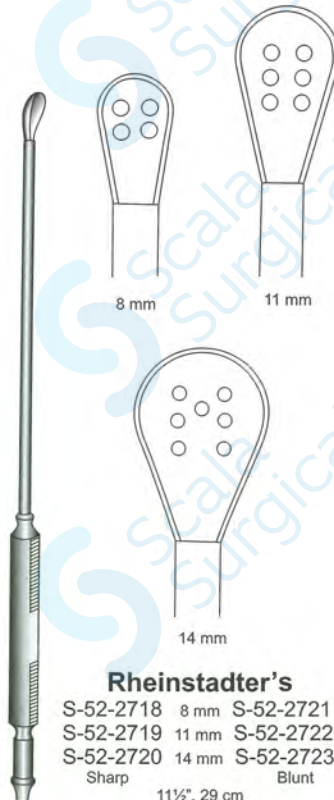

Rheinstadter's
S-52-2718 8 mm S-52-2721
S-52-2719 11 mm S-52-2722
S-52-2720 14 mm S-52-2723
Sharp Blunt
11½", 29 cm



Evans
S-52-2724 8 mm
S-52-2725 10 mm
S-52-2726 12 mm
S-52-2727 14 mm

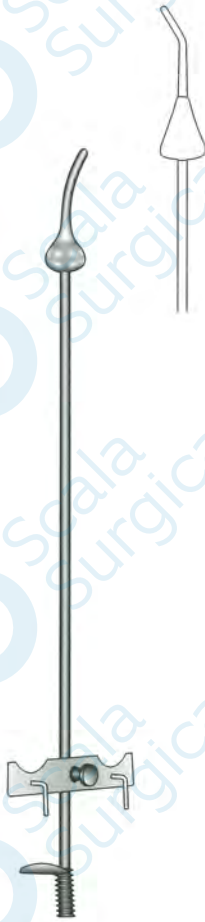

Spackman

S-52-2729 Metal Acorn
S-52-2730 Rubber Acorn
S-52-2731 Rubber Acorn Only



Provis

S-52-2732 Metal Cone
S-52-2733 Rubber Cone

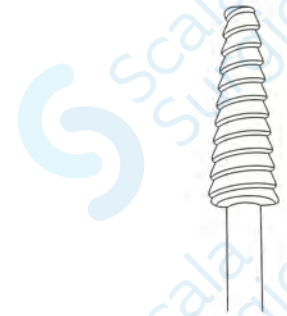

S-52-2734
10 mm
Cone



S-52-2735
13 mm
Cone



S-52-2736
16 mm
Cone



Leech-Wilkinson

Gynecological



Carton
S-52-2737



Bozemmann-Fritch
S-52-2738



Drewsmythe
S-52-2739



Obstetric
S-52-2740
Blunt Hook

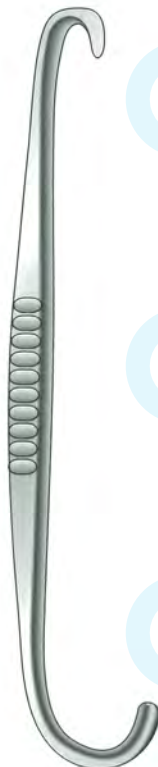

Obstetric
S-52-2741
Hook & Crochet



Target
S-52-2742
Hook



Jardines
S-52-2743
Decapitator

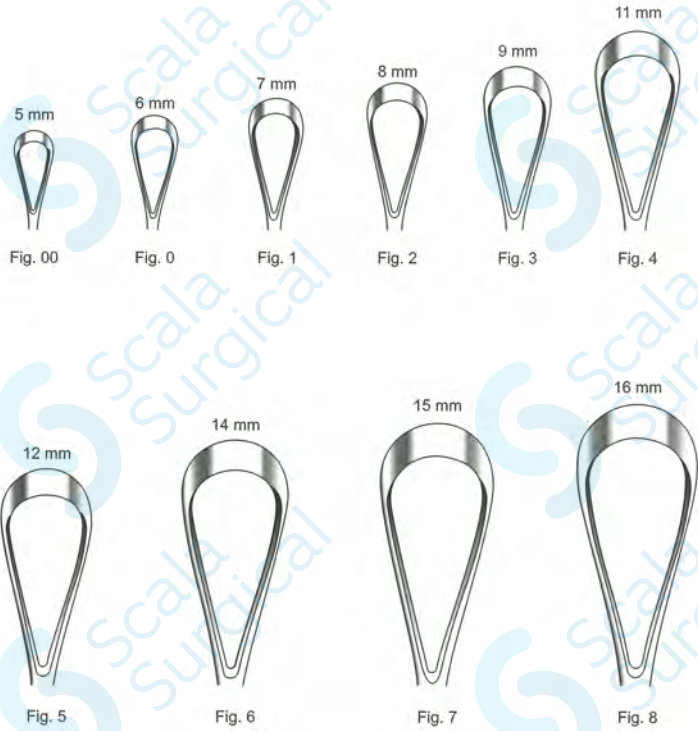

Sims Rigid
12½", 31.8 cm
Shaft

Malleable
12½", 31.8 cm
Shaft

Rigid	Fig.	Malleable
S-52-2744	00 5 mm	S-52-2754
S-52-2745	0 6 mm	S-52-2755
S-52-2746	1 7 mm	S-52-2756
S-52-2747	2 8 mm	S-52-2757
S-52-2748	3 9 mm	S-52-2758
S-52-2749	4 11 mm	S-52-2759
S-52-2750	5 12 mm	S-52-2760
S-52-2751	6 14 mm	S-52-2761
S-52-2752	7 15 mm	S-52-2762
S-52-2753	8 16 mm	S-52-2763

Sharp

Rigid	Fig.	Malleable
S-52-2764	00 5 mm	S-52-2774
S-52-2765	0 6 mm	S-52-2775
S-52-2766	1 7 mm	S-52-2776
S-52-2767	2 8 mm	S-52-2777
S-52-2768	3 9 mm	S-52-2778
S-52-2769	4 11 mm	S-52-2779
S-52-2770	5 12 mm	S-52-2780
S-52-2771	6 14 mm	S-52-2781
S-52-2772	7 15 mm	S-52-2782
S-52-2773	8 16 mm	S-52-2783

Blunt

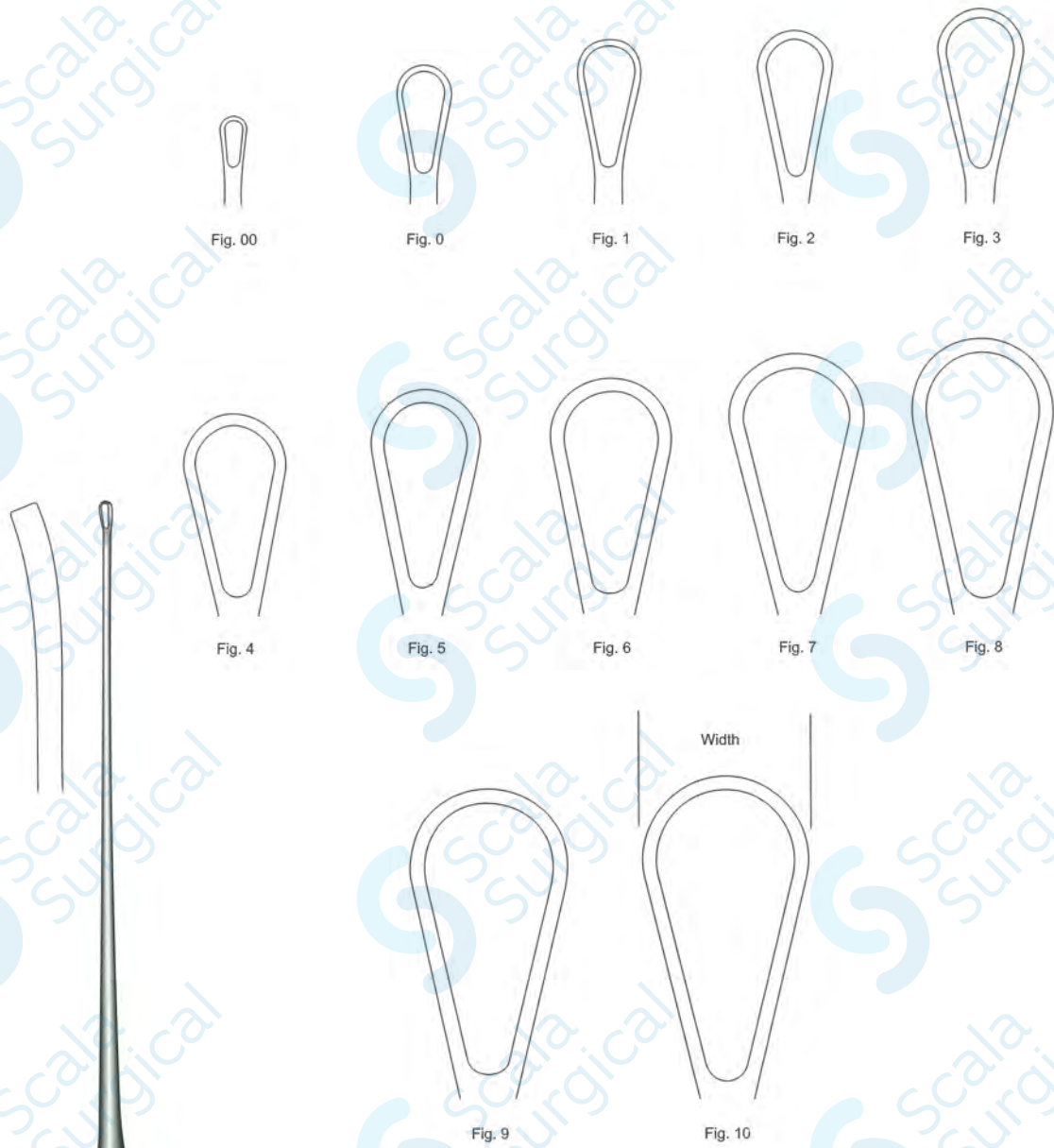

Recamier

Sharp	Fig.	Size	Blunt
S-52-2784	00	4.5 mm	S-52-2796
S-52-2785	0	7.5 mm	S-52-2797
S-52-2786	1	8.5 mm	S-52-2798
S-52-2787	2	10.5 mm	S-52-2799
S-52-2788	3	12 mm	S-52-2800
S-52-2789	4	14 mm	S-52-2801
S-52-2790	5	15 mm	S-52-2802
S-52-2791	6	16.5 mm	S-52-2803
S-52-2792	7	18 mm	S-52-2804
S-52-2793	8	19.5 mm	S-52-2805
S-52-2794	9	21.5 mm	S-52-2806
S-52-2795	10	23.5 mm	S-52-2807

Uterine Curettes

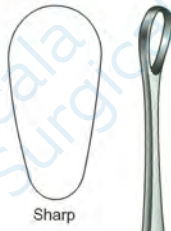

- S-52-2810 Small
- S-52-2811 Medium
- S-52-2812 Large
- Sharp / Blunt
- S-52-2815 Small
- S-52-2816 Medium
- S-52-2817 Large
- Sharp / Sharp
- S-52-2820 Small
- S-52-2821 Medium
- S-52-2822 Large
- Blunt / Blunt

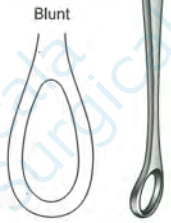
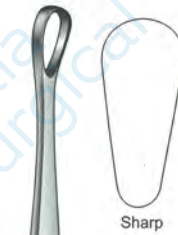

Sims
10", 25.5 cm

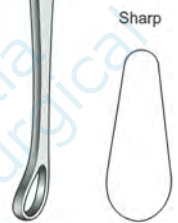

Sims
10", 25.5 cm

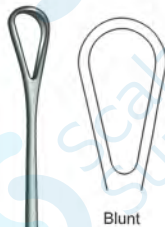

Blake
S-52-2827
10¾", 27.5 cm

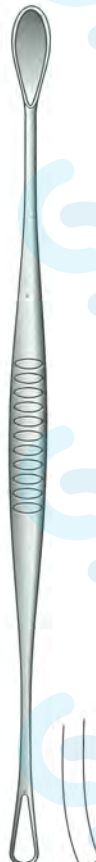

Scoop / Curette
S-52-2829
10¾", 25.5 cm

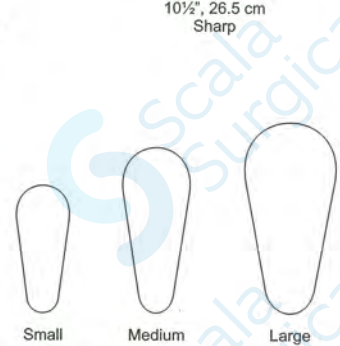

Sims
10", 25.5 cm

- S-52-2830 Small
- S-52-2831 Medium
- S-52-2832 Large
- Sharp
- S-52-2834 Small
- S-52-2835 Medium
- S-52-2836 Large
- Blunt

Hysterectomy Clamps



S-52-2840 8¼", 21 cm
 S-52-2841 9½", 24 cm
 S-52-2842 11¼", 30 cm
 S-52-2843 14", 35 cm
 S-52-2844 16¼", 41 cm
 Straight
 Hysterectomy Clamp



S-52-2845 8¼", 21 cm
 S-52-2846 9½", 24 cm
 S-52-2847 11¼", 30 cm
 S-52-2848 14", 35 cm
 S-52-2849 16¼", 41 cm
 Angled
 Hysterectomy Clamp

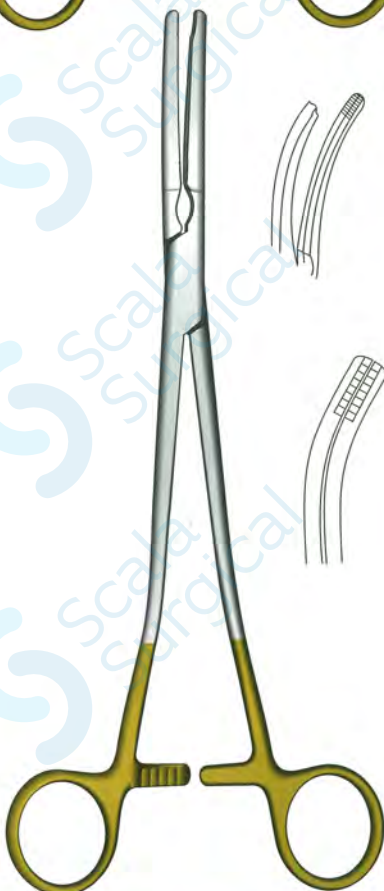

S-52-2850 8¼", 21 cm
 S-52-2851 9½", 24 cm
 S-52-2852 11¼", 30 cm
 S-52-2853 14", 35 cm
 S-52-2854 16¼", 41 cm
 Curve
 Hysterectomy Clamp



S-52-2855 8¼", 21 cm
 S-52-2856 9½", 24 cm
 S-52-2857 11¼", 30 cm
 S-52-2858 14", 35 cm
 S-52-2859 16¼", 41 cm
 2nd Curve
 Hysterectomy Clamp

Hysterectomy Forceps

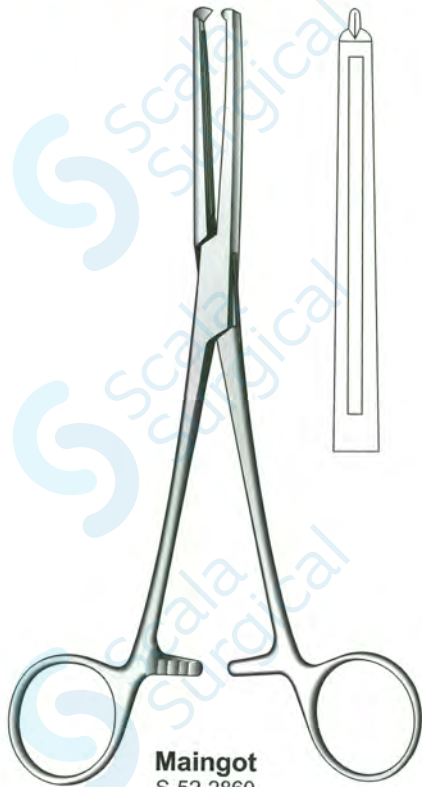

Maingot
S-52-2860
8", 20 cm
Straight

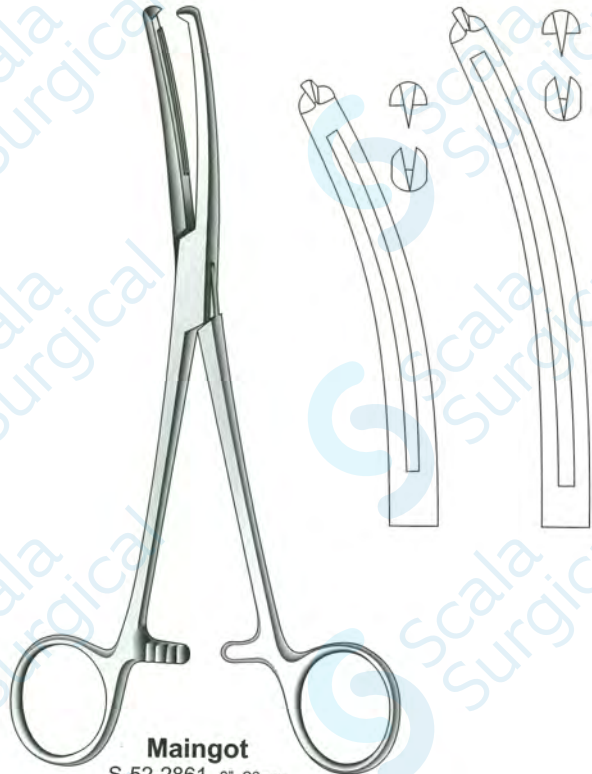

Maingot
S-52-2861 8", 20 cm
S-52-2862 10", 25.5 cm
Curved

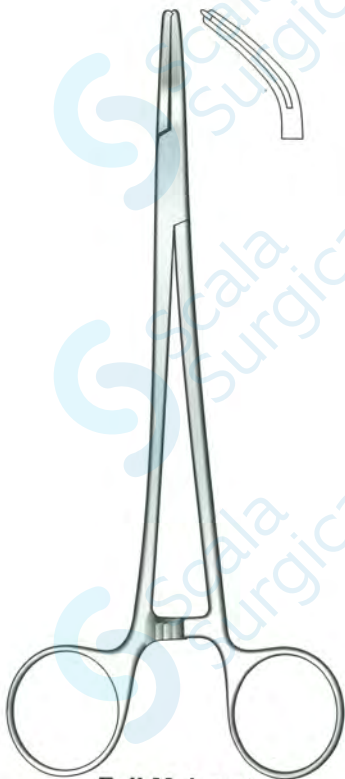

Fell Maingot
S-52-2863
8", 20 cm
Angled

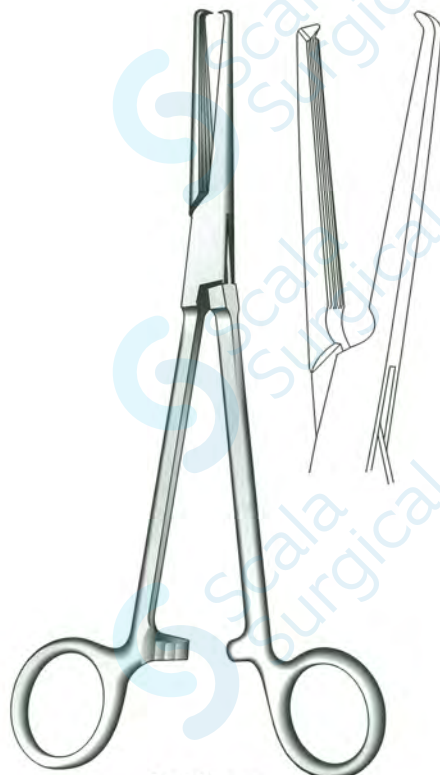

Gwilliam
S-52-2864
8", 20 cm
Straight

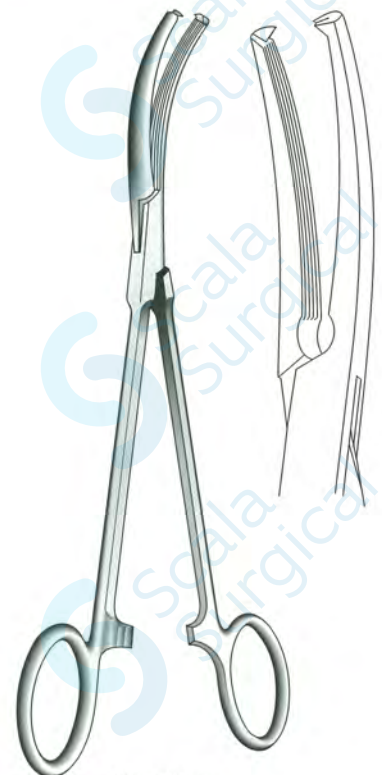

Gwilliam
S-52-2865
8", 20 cm
Curved

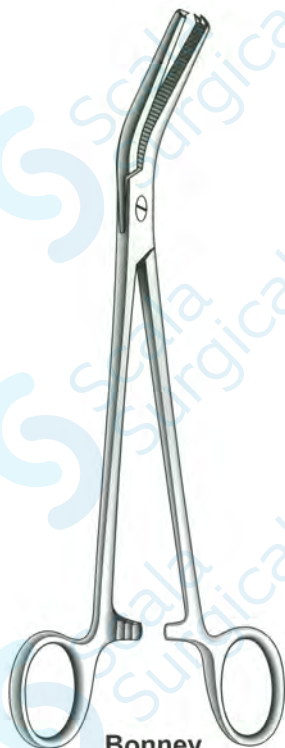

Bonney
S-52-2866
7¾", 19.5 cm
1:2 Teeth
Angled on Flat

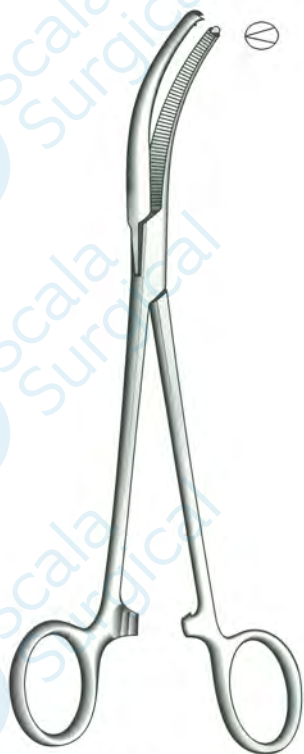

Berkeley Bonney
S-52-2867
8", 20 cm
1:2 Teeth
Curved on Flat



Chelsae Hospital Pattern
S-52-2868 Straight
S-52-2869 Curved
8", 20 cm
1:2 Teeth

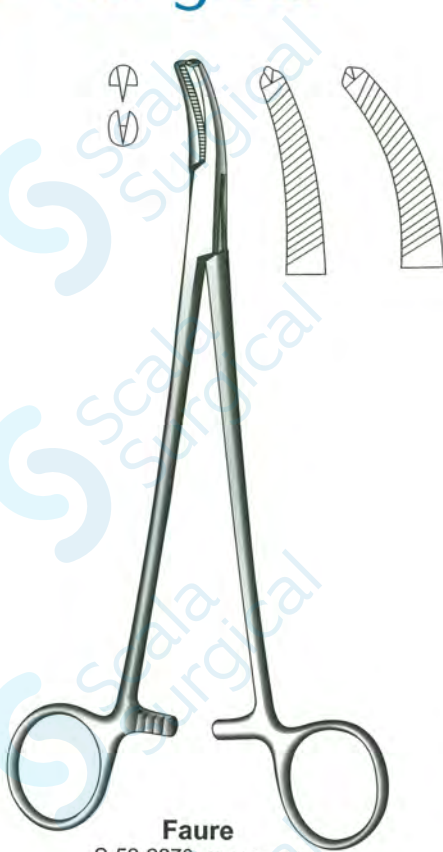

Faure
S-52-2870 Slight Curved
S-52-2871 Deeper Curve
1:2 Teeth
8", 20 cm



Mikulicz
S-52-2873
8", 20 cm



Mikulicz
S-52-2874
8", 20 cm

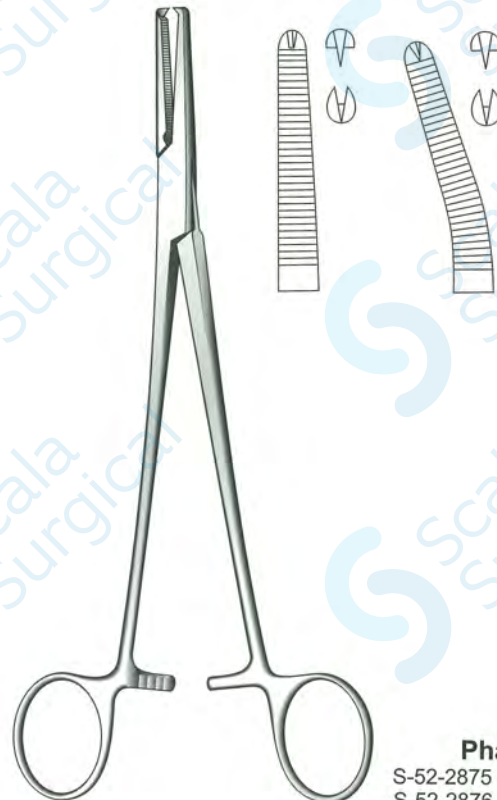

Phaneuf
S-52-2875 Straight, 8½", 21 cm
S-52-2876 Curved, 8", 20 cm

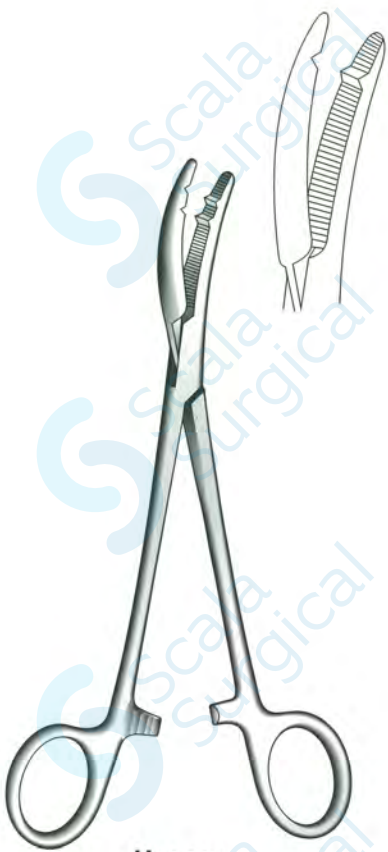

Heaney
 S-52-2877 Single Tooth
 S-52-2878 Double Tooth
 8", 20 cm
 Curved

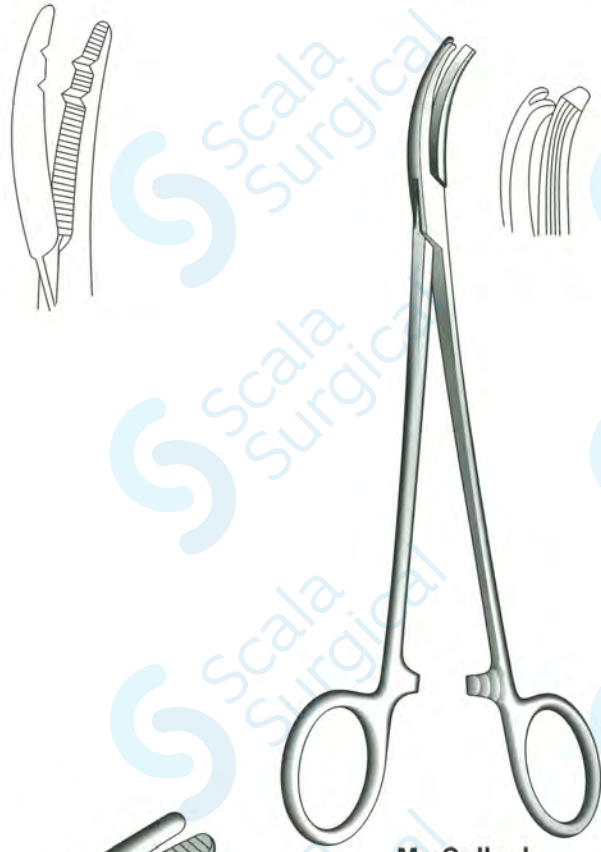

Mc Cullagh
 S-52-2879 Straight, 8 3/4", 22.5 cm
 S-52-2880 Curved, 9", 23 cm

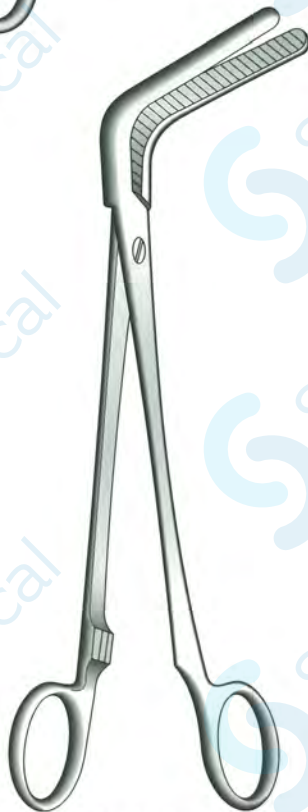

Wertheim
 S-52-2881
 10", 25.5 cm
 Angled Jaw

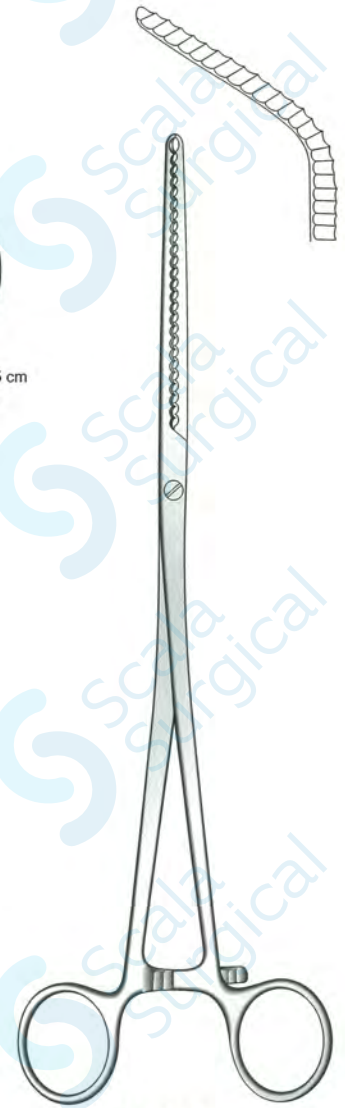

Wertheim
 S-52-2882
 10", 25.5 cm
 Angled on Flat

Cervical Biopsy Forceps

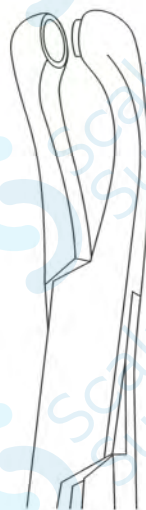

Thomas Gaylor
S-52-2884
9½", 24 cm

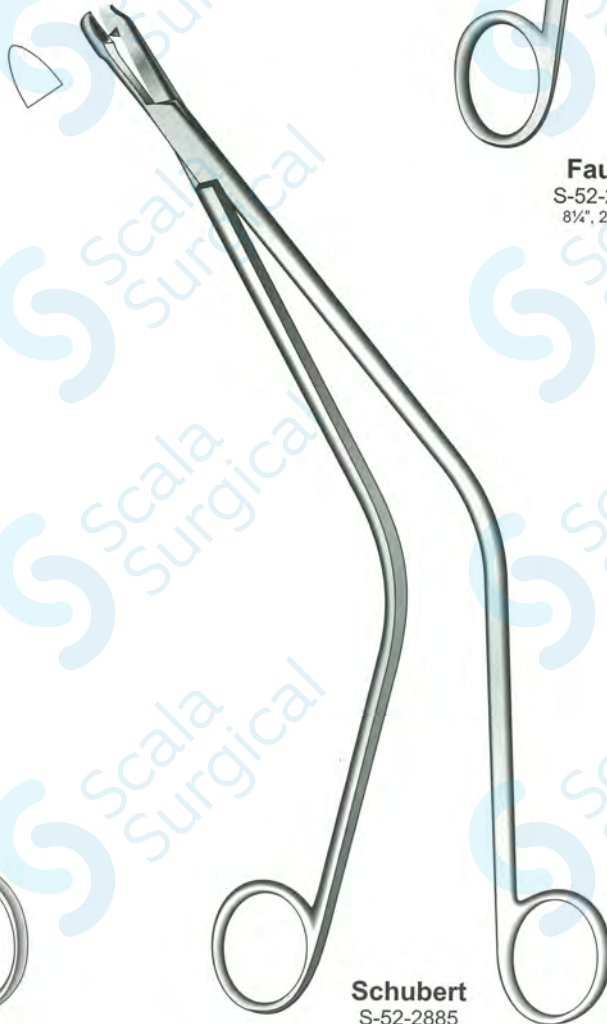

Schubert
S-52-2885
10¼", 26 cm

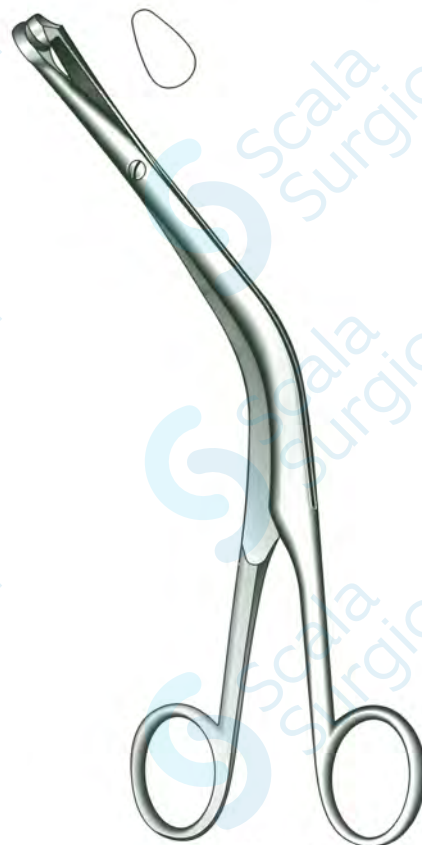

Faure
S-52-2883
8¼", 21 cm

Biopsy Punch Forceps

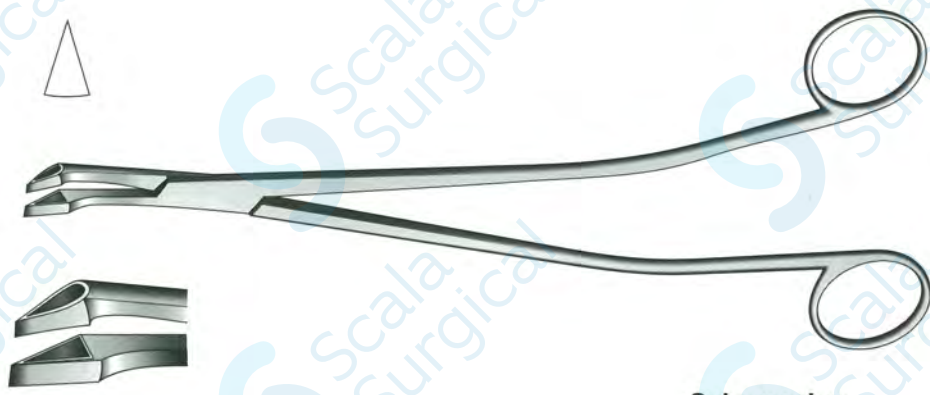

Schumacher
S-52-2886
9½", 24 cm



Schumacher
S-52-2887
9½", 24 cm Shaft

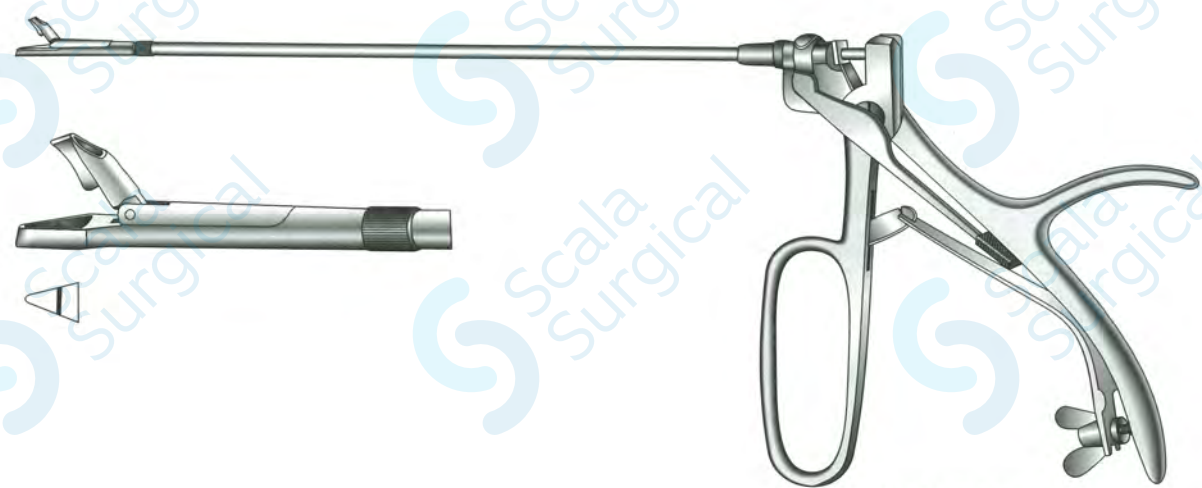

Schumacher
S-52-2888
Universal Handle

Biopsy Punch Forceps



Tischler
S-52-2889
8", 20 cm
Box Joint, Angled Joint



Tischler Morgan
S-52-2890 Mini
S-52-2891 Standard
One Oval Ring

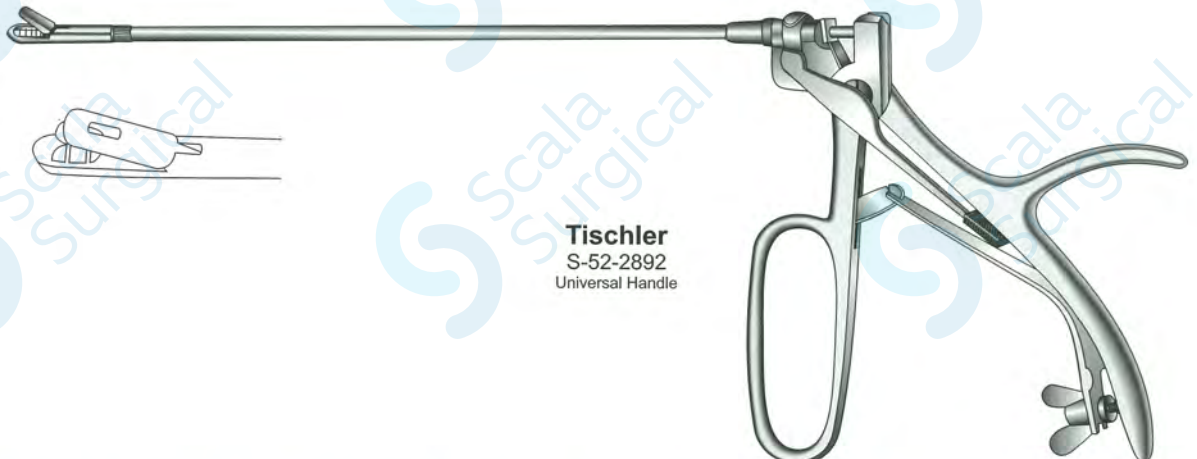

Tischler
S-52-2892
Universal Handle

Biopsy Punch Forceps



Kevorkian Younger

S-52-2893

10½", 26 cm

9" Shaft

Basket jaws



Eppendorfer

S-52-2894

8", 20 cm Shaft

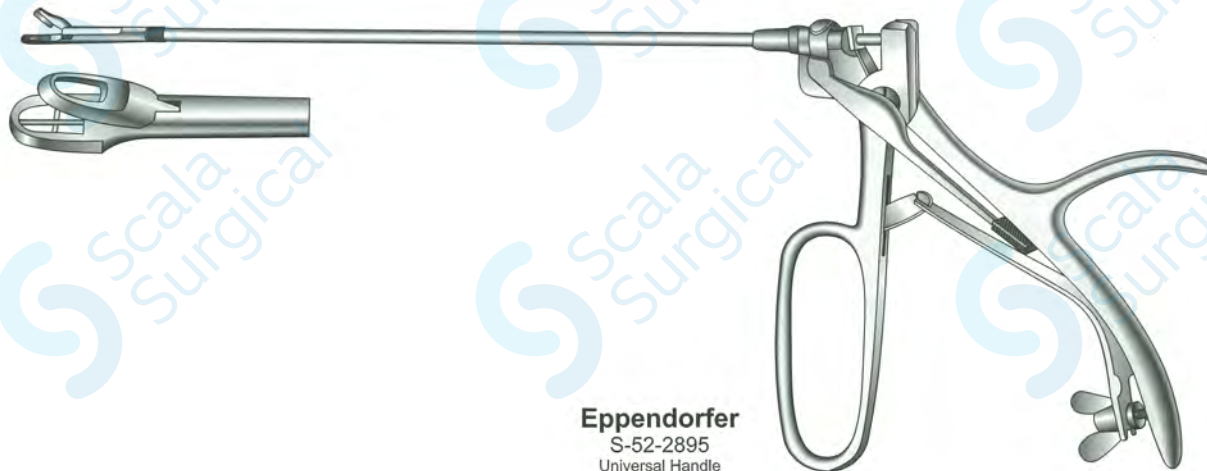

Eppendorfer

S-52-2895

Universal Handle

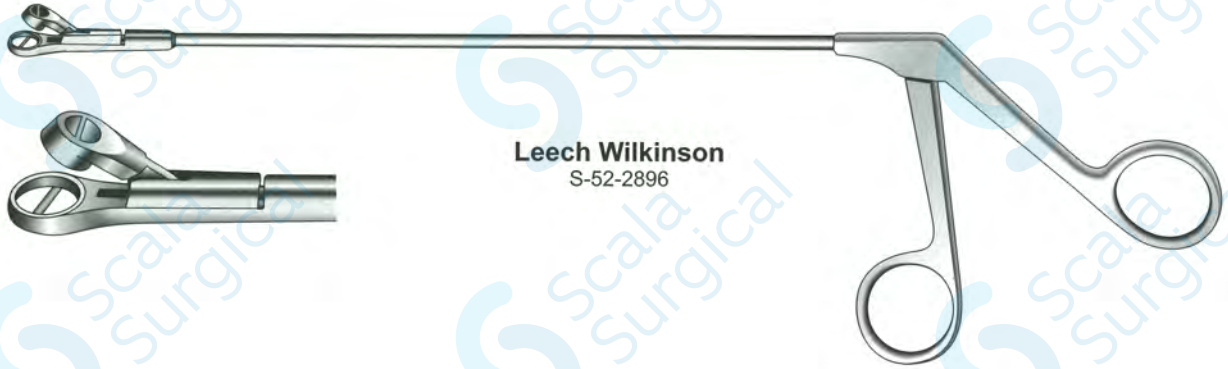

Leech Wilkinson
S-52-2896



Wittner
S-52-2897 Straight
S-52-2898 Curved

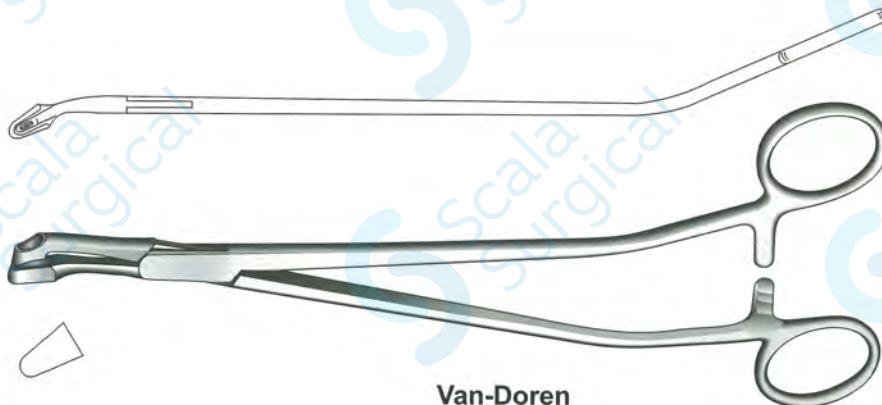

Van-Doren
S-52-2899

Vaginal Speculum

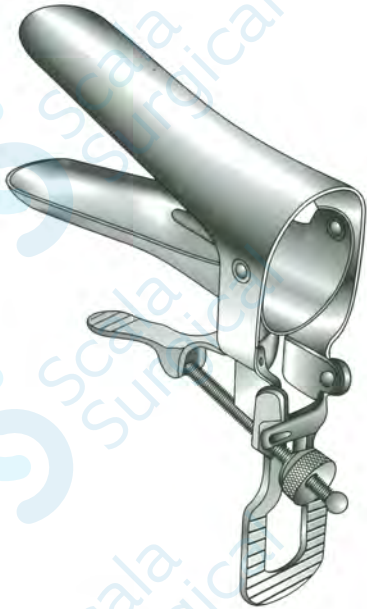

Cusco

- S-52-2900 Virgin, 86 x 16 mm
- S-52-2901 Virgin, Extra Long, 115 x 16 mm
- S-52-2902 Small, 95 x 25 mm
- S-52-2903 Small, Extra Long, 115 x 25 mm
- S-52-2904 Medium, 102 x 30 mm
- S-52-2905 Medium, Extra Long, 115 x 30 mm
- S-52-2906 Large, 115 x 35 mm
- S-52-2907 Large, Extra Long, 125 x 35 mm
- S-52-2908 Large, Extra Extra Long, Extra Extra Wide

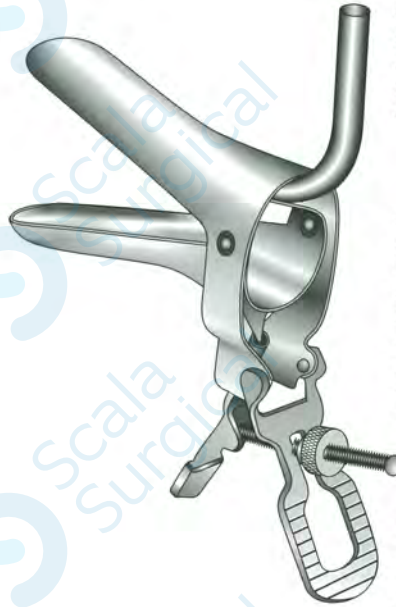

Cusco

- S-52-2910 Virgin, 86 x 16 mm
- S-52-2911 Virgin, Extra Long, 115 x 16 mm
- S-52-2912 Small, 95 x 25 mm
- S-52-2913 Small, Extra Long, 115 x 25 mm
- S-52-2914 Medium, 102 x 30 mm
- S-52-2915 Medium, Extra Long, 115 x 30 mm
- S-52-2916 Large, 115 x 35 mm
- S-52-2917 Large, Extra Long, 125 x 35 mm
- S-52-2918 Large, Extra Extra Long, Extra Extra Wide
With Smoke Tube, Bead Finish

Cusco

- S-52-2920 Virgin, 86 x 16 mm
- S-52-2921 Virgin, Extra Long, 115 x 16 mm
- S-52-2922 Small, 95 x 25 mm
- S-52-2923 Small, Extra Long, 115 x 25 mm
- S-52-2924 Medium, 102 x 30 mm
- S-52-2925 Medium, Extra Long, 115 x 30 mm
- S-52-2926 Large, 115 x 35 mm
- S-52-2927 Large, Extra Long, 125 x 35 mm
- S-52-2928 Large, Extra Extra Long, Extra Extra Wide
With Smoke Tube, Insulated

Cusco

- S-52-2930 Virgin, 86 x 16 mm
- S-52-2931 Virgin, Extra Long, 115 x 16 mm
- S-52-2932 Small, 95 x 25 mm
- S-52-2933 Small, Extra Long, 115 x 25 mm
- S-52-2934 Medium, 102 x 30 mm
- S-52-2935 Medium, Extra Long, 115 x 30 mm
- S-52-2936 Large, 115 x 35 mm
- S-52-2937 Large, Extra Long, 125 x 35 mm
- S-52-2938 Large, Extra Extra Long, Extra Extra Wide
With Smoke Tube, Blackend



Cusco

- | | |
|------------------|--------------------------|
| S-52-2940 Virgin | S-52-2945 |
| S-52-2941 Small | S-52-2946 |
| S-52-2942 Medium | S-52-2947 |
| S-52-2943 Large | S-52-2948 |
| Chrome Plated | Chrome Plated |
| | With Provision for Light |



Cusco

- S-52-2950 Small
- S-52-2951 Medium
- S-52-2952 Large
Fenestrated

Vaginal Speculum



Graves (Brewer)

S-52-2955	Small	75x20 mm
S-52-2956	Medium	95x35 mm
S-52-2957	Large	115x35 mm



Graves (Brewer)

S-52-2960	Small	75x20 mm	S-52-2965
S-52-2961	Medium	95x35 mm	S-52-2966
S-52-2962	Large	115x35 mm	S-52-2967
With smoke Tube			With smoke Tube
Bead Finish			Insulated

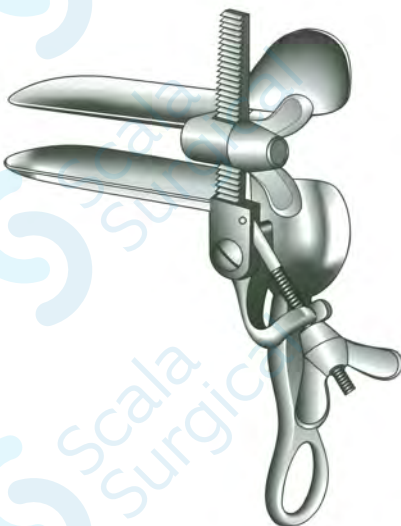

Trelat

S-52-2970	Small	85x35 mm
S-52-2971	Medium	95x35 mm
S-52-2972	Large	115x35 mm
Parallel Adjustment		

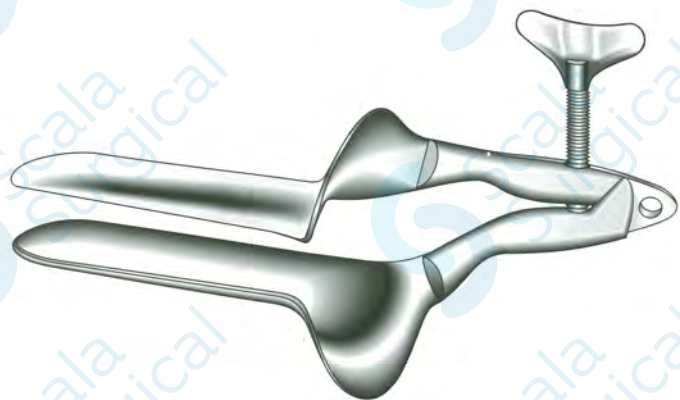

Collin

S-52-2975	Small	85x30 mm
S-52-2976	Medium	100x35 mm
S-52-2977	Large	110x40 mm

Vaginal Speculum



Bailey
S-52-2980
Blade 3", 7.5 cm Long
1½", 4 cm Wide



Auvard
S-52-2982
Blade 3½", 9 cm Long
1¾", 4.5 cm Wide
With Removable Weight



Auvard
S-52-2984
Blade 3½", 9 cm Long
1¾", 4.5 cm Wide
With Fixed Weight



Breisky

S-52-3010	Blade 100 x 20 mm
S-52-3011	Blade 100 x 25 mm
S-52-3012	Blade 100 x 30 mm
S-52-3013	Blade 100 x 35 mm
S-52-3014	Blade 100 x 40 mm
S-52-3015	Blade 130 x 20 mm
S-52-3016	Blade 130 x 25 mm
S-52-3017	Blade 130 x 30 mm
S-52-3018	Blade 130 x 35 mm
S-52-3019	Blade 130 x 40 mm
S-52-3020	Blade 160 x 40 mm
S-52-3021	Blade 180 x 40 mm

(Vienna Pattern)

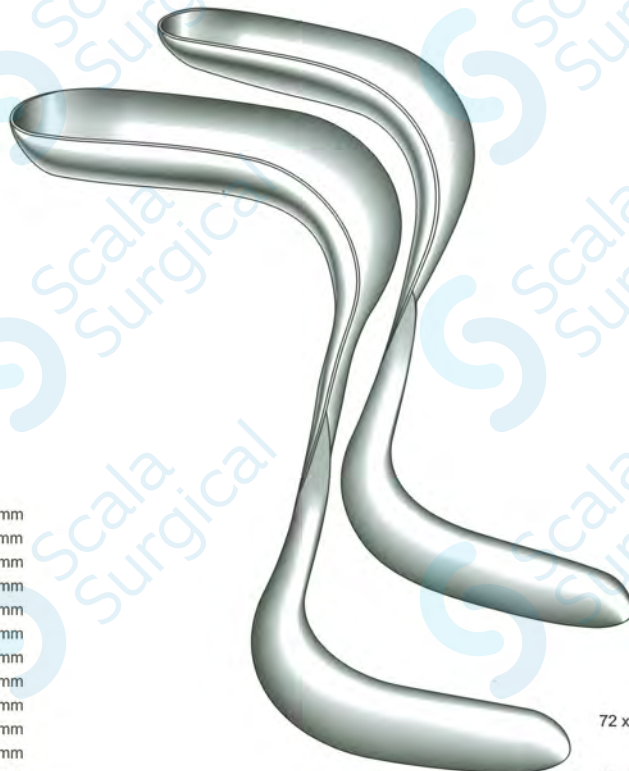

Breisky
S-52-3025
72 x 25 mm / 77 x 30 mm
5½", 14 cm
S-52-3028
75 x 30 mm / 92 x 38 mm
6¾", 17 cm

Vaginal Speculum



Sims

- S-52-3030 Small
- S-52-3032 Medium
- S-52-3034 Large
- Single Ended



Sims

- S-52-3036 Small
- S-52-3038 Medium
- S-52-3040 Large
- Double Ended Insulated



Sims

- S-52-3044 Small
- Blade 2 1/8" x 7/8" (5.5 cm x 2.2 cm)
- 2 1/4" x 1" (6.0 cm x 2.5 cm)
- S-52-3046 Medium
- Blade 2 1/2" x 1" (6.5 cm x 2.5 cm)
- 2 3/4" x 1 1/4" (7.0 cm x 3.0 cm)
- S-52-3048 Large
- Blade 2 3/4" x 1 1/8" (7.0 cm x 2.8 cm)
- 3 1/4" x 1 3/8" (8.0 cm x 3.5 cm)
- Double Ended



St. Georges

- S-52-3052
- Hospital Pattern
- 95 x 25 mm, 115 x 30 mm



Jessop

- S-52-3054
- Hospital Pattern
- 100 x 28 mm, 120 x 30 mm



Liverpool

- S-52-3056
- Hospital Pattern
- 100 x 16 mm, 120 x 22 mm

Vaginal Speculum



Currie

- S-52-3060 Small, 1", 2.5 cm Wide
- S-52-3062 Medium, 1½", 3 cm Wide
- S-52-3064 Large, 1¾", 3.5 cm Wide
14½", Hollow Handle



Kristlaer

- S-52-3066 110 x 20 mm
- S-52-3067 110 x 30 mm
- S-52-3068 110 x 36 mm



Doyen (Pozzi)

- S-52-3070 Small, 48 x 60 mm
- S-52-3071 Medium, 48 x 90 mm
- S-52-3072 Large, 48 x 124 mm



Doyen

- S-52-3073
Narrow Blade

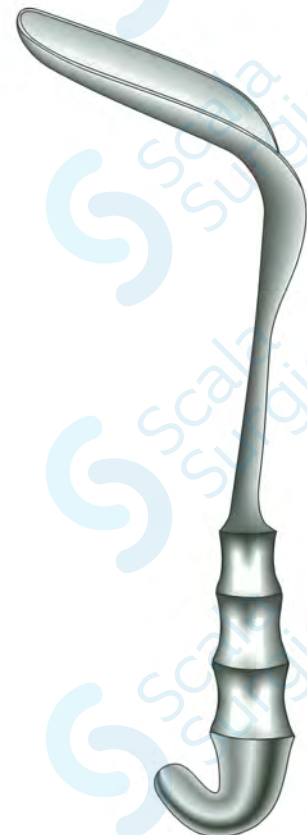

Swayer

- S-52-3077 Small, 2½" x 7/8"
- S-52-3078 Medium, 3" x 1-1/8"
- S-52-3079 Large, 3½" x 1½"



Semm

- S-52-3082 Small, 100 x 20 mm
 - S-52-3084 Medium, 100 x 30 mm
- Single Hand Use



Winterton

- S-52-3085 Without Provision For Light
- S-52-3086 With Provision For Light
- S-52-3087 With Smoke Tube / Bead Finish
- S-52-3088 With Smoke Tube / Insulated
130 x 23 mm

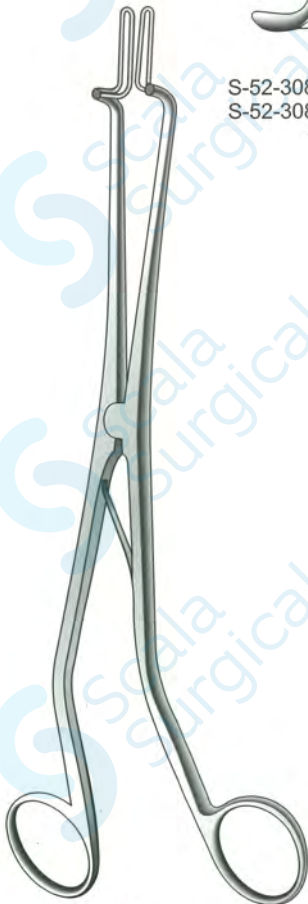

Kogan
S-52-3090
9 1/2", 24 cm

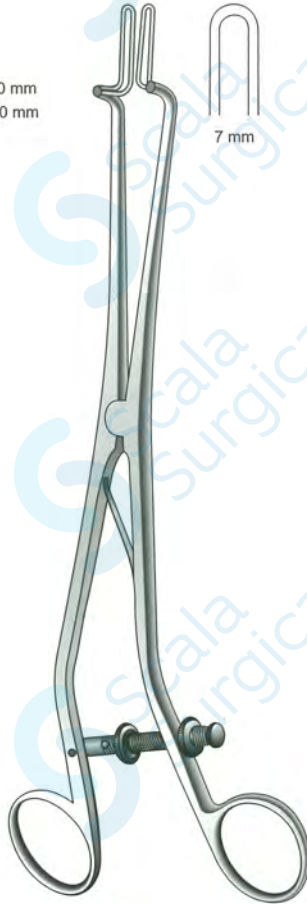

Kogan
S-52-3092 With Screw Ratchet
S-52-3094 With Finger Ratchet



Soonawala
S-52-3098

Retractors

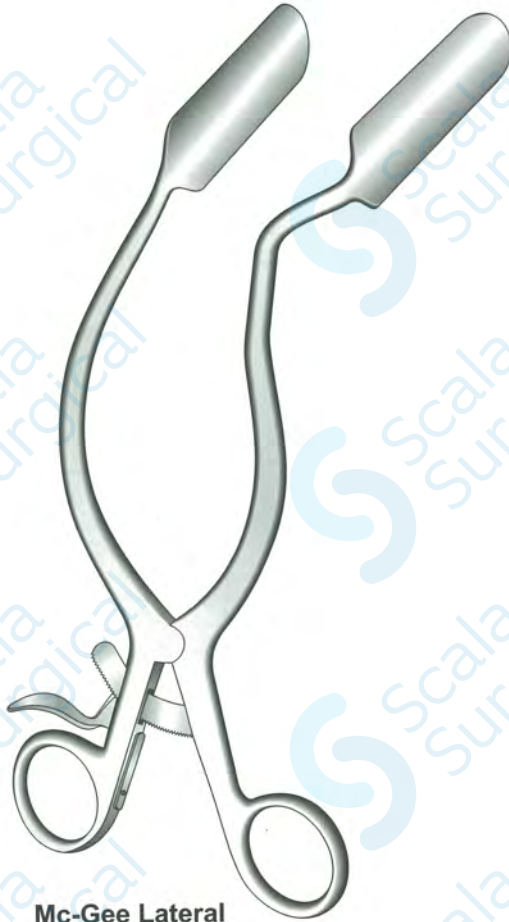

Mc-Gee Lateral
S-52-3100
Wall Retractor

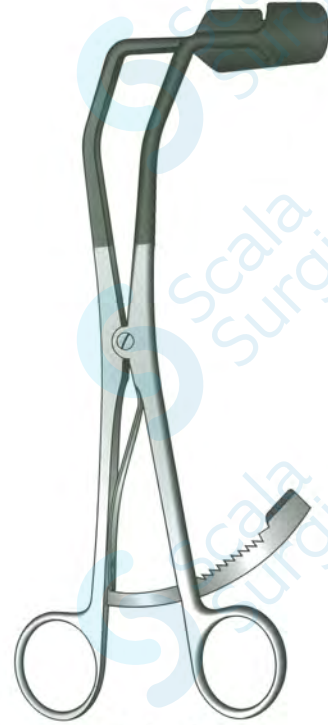

Lateral
S-52-3102
Wall Retractor



Lateral
S-52-3104
Retractor



Pessary
S-52-3105
Introducers

Uterine Dilators



Hegar

Double Ended

S-52-3210	1/2
S-52-3211	3/4
S-52-3212	5/6
S-52-3213	7/8
S-52-3214	9/10
S-52-3215	11/12
S-52-3216	13/14
S-52-3217	15/16
S-52-3218	17/18
S-52-3219	19/20
S-52-3220	21/22
S-52-3221	23/24
S-52-3222	25/26
S-52-3223	27/28
S-52-3224	29/30
S-52-3225	31/32
S-52-3226	33/34
S-52-3228	Set of 8 (1/2 - 17/18)
S-52-3229	Set of 12



Hegar

Single Ended

S-52-3230	1 mm
S-52-3231	1.5 mm
S-52-3232	2 mm
S-52-3233	2.5 mm
S-52-3234	3 mm
S-52-3235	3.5 mm
S-52-3236	4 mm
S-52-3237	4.5 mm
S-52-3238	5 mm
S-52-3239	5.5 mm
S-52-3240	6 mm
S-52-3241	6.5 mm
S-52-3242	7 mm
S-52-3243	7.5 mm
S-52-3244	8 mm
S-52-3245	8.5 mm
S-52-3246	9 mm
S-52-3247	9.5 mm
S-52-3250	10 mm
S-52-3251	10.5 mm
S-52-3252	11 mm
S-52-3253	11.5 mm
S-52-3254	12 mm
S-52-3255	12.5 mm
S-52-3256	13 mm
S-52-3257	13.5 mm
S-52-3258	14 mm
S-52-3259	14.5 mm
S-52-3260	15 mm
S-52-3261	16 mm
S-52-3262	17 mm
S-52-3263	18 mm
S-52-3264	19 mm
S-52-3265	20 mm
S-52-3266	21 mm
S-52-3267	22 mm
S-52-3268	23 mm



Bonney Barker

S-52-3275	3/5
S-52-3276	4/6
S-52-3277	5/7
S-52-3278	6/8
S-52-3279	7/9
S-52-3280	8/10
S-52-3281	9/11
S-52-3282	10/12
S-52-3283	11/13
S-52-3284	12/14
S-52-3285	13/15
S-52-3286	14/16
S-52-3287	15/17
S-52-3288	16/18
S-52-3289	17/19
S-52-3290	18/20



Hawkin Ambler

S-52-3295	3/6
S-52-3296	4/7
S-52-3297	5/8
S-52-3298	6/9
S-52-3299	7/10
S-52-3300	8/11
S-52-3301	9/12
S-52-3302	10/13
S-52-3303	11/14
S-52-3304	12/15
S-52-3305	13/16
S-52-3306	14/17
S-52-3307	15/18
S-52-3308	16/19
S-52-3309	17/20
S-52-3310	18/21
S-52-3311	Set of 16

Uterine Dilators

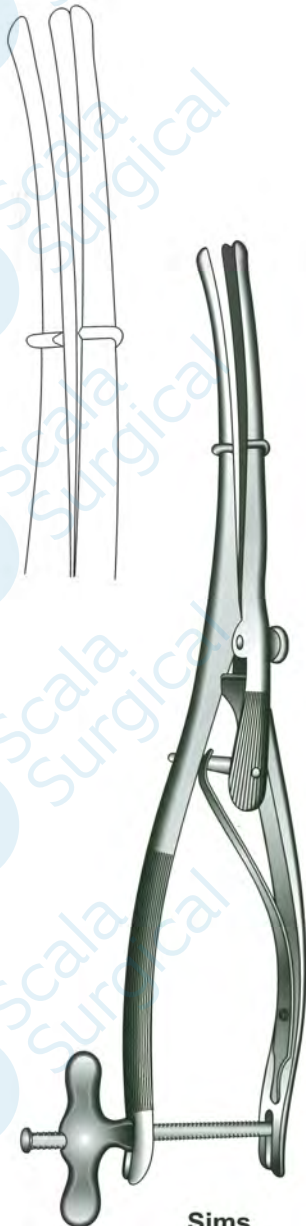

Sims
S-52-3325
3 Prongs



Hank

- S-52-3315 Set of 6
- S-52-3316 9/10 FG
- S-52-3317 11/12 FG
- S-52-3318 13/14 FG
- S-52-3319 15/16 FG
- S-52-3320 17/18 FG
- S-52-3321 19/20 FG



Umbilical Cord
S-52-3330
Dilator

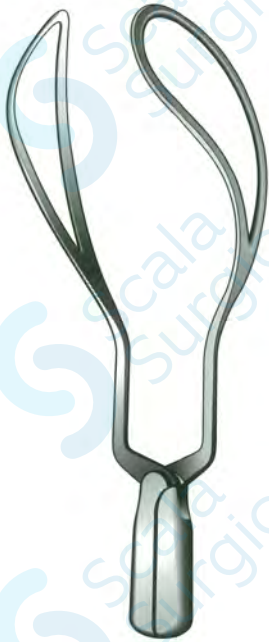

Wrigley
S-52-3340
10", 25.5 cm

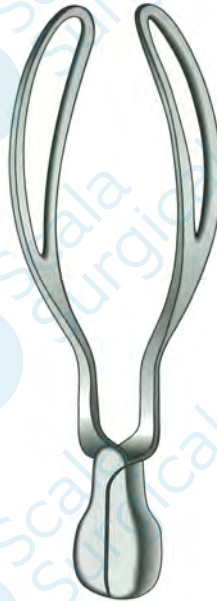

Simpson
S-52-3342
9 1/4", 23.5 cm
Short Model



Simpson-Braun
S-52-3343
12", 30.5 cm



Simpson-Braun
S-52-3344
14", 35.5 cm

Obstetric Forceps

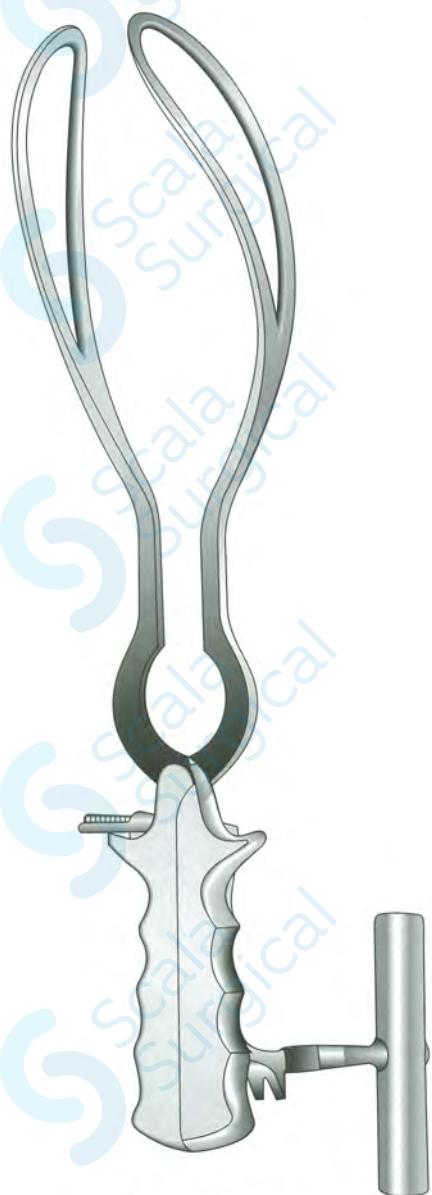

Barnes-Neville
S-52-3346
17", 43.5 cm

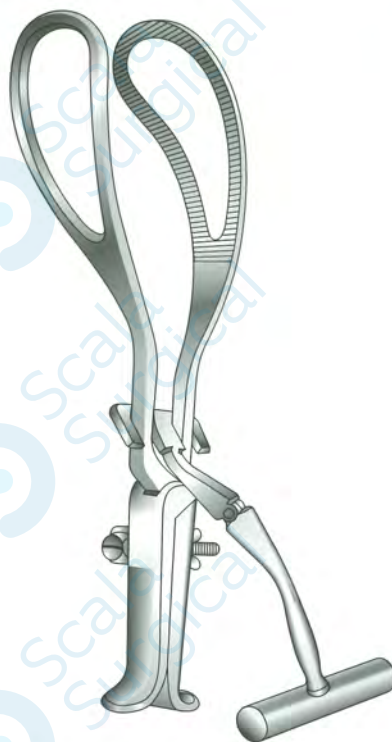

Haig Fergusson
S-52-3348
13½", 34.5 cm

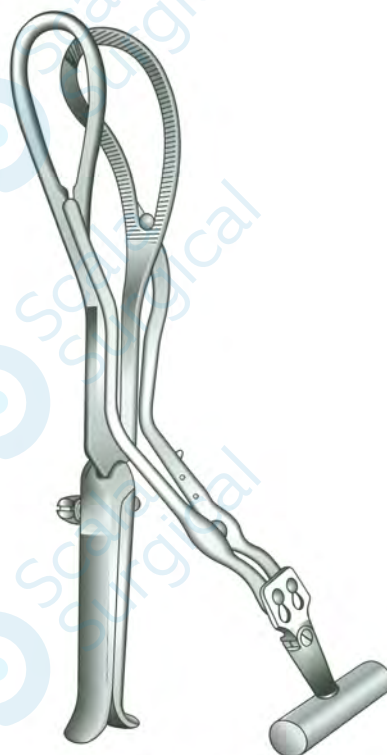

Milne Murray's
S-52-3350
16", 40.5 cm



Piper
S-52-3352
17½", 44.5 cm

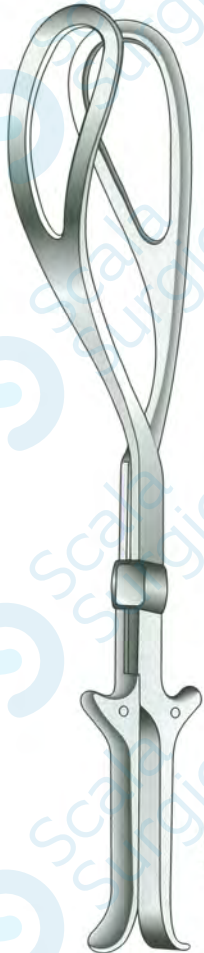

Kielland
S-52-3356
16", 40.5 cm



Tarnier
S-52-3354
16", 40.5 cm

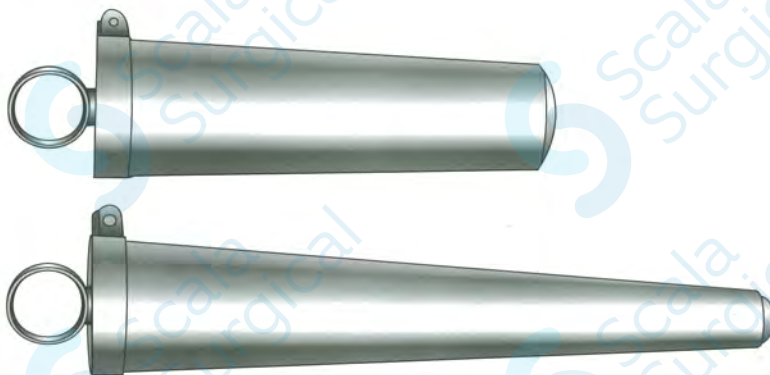

Endoscopes

- S-52-3361 5", Long 30mm Diameter
- S-52-3362 6½", Long 22 mm Diameter
- S-52-3363 6½", Long 30 mm Diameter
- S-52-3364 8", Long 12 mm Diameter
- S-52-3365 8", Long 16 mm Diameter
- S-52-3366 8", Long 20 mm Diameter
- S-52-3367 8", Long 30 mm Diameter



Swab Holding
S-52-3369
3:4 Teeth / With Ratchet

Obstetric & Foetal Blood Sampling Instruments



Blade Holders
 S-52-3370 Plug in Type
 S-52-3371 Screw in Type

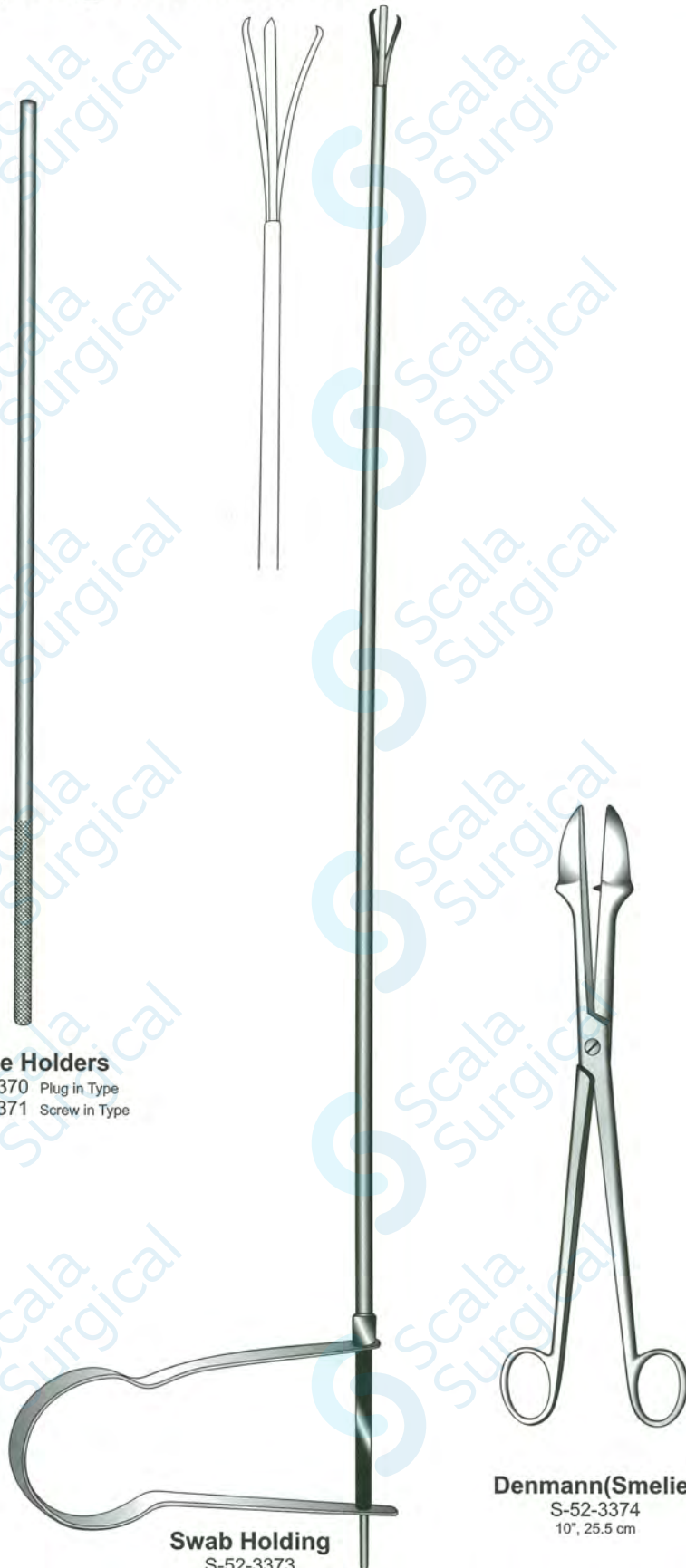

Swab Holding
 S-52-3373
 3 Prongs / With U Spring



Denmann(Smelie)
 S-52-3374
 10", 25.5 cm

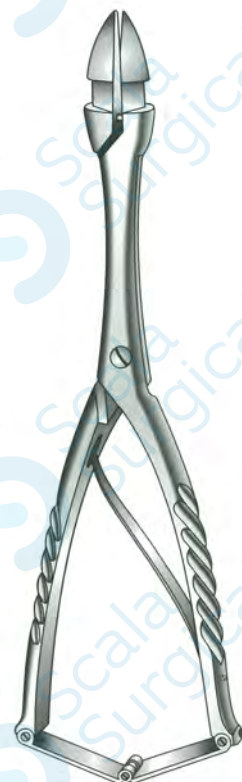

Simpson
 S-52-3375
 12", 30.5 cm

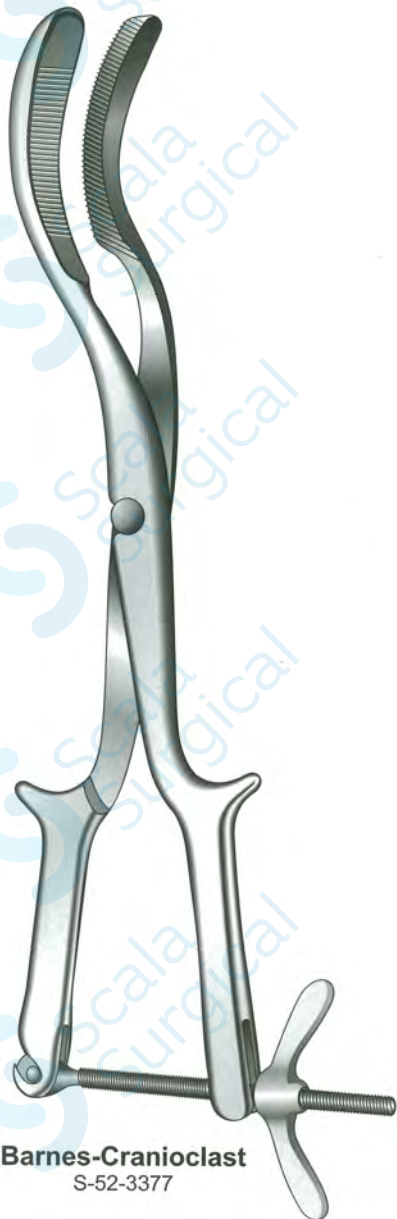

Barnes-Cranioclast
S-52-3377



Simpson-Cranioclast
S-52-3376

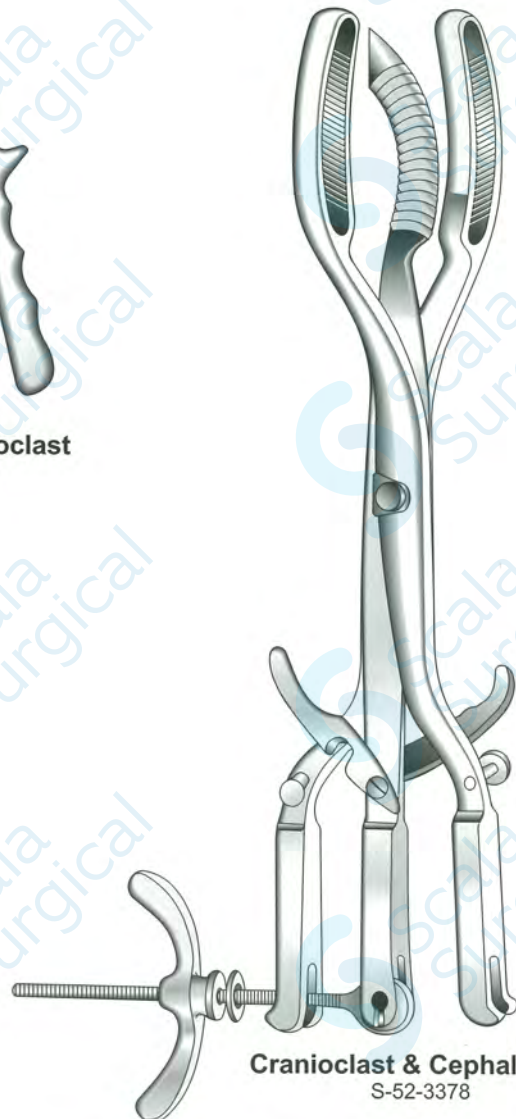

Cranioclast & Cephalotribe
S-52-3378