

Stethoscopes

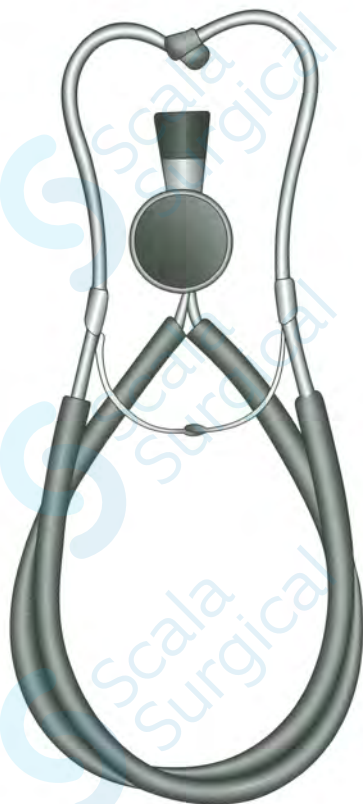

Sprague Bowles
S-01-0004



Bowles
S-01-0005

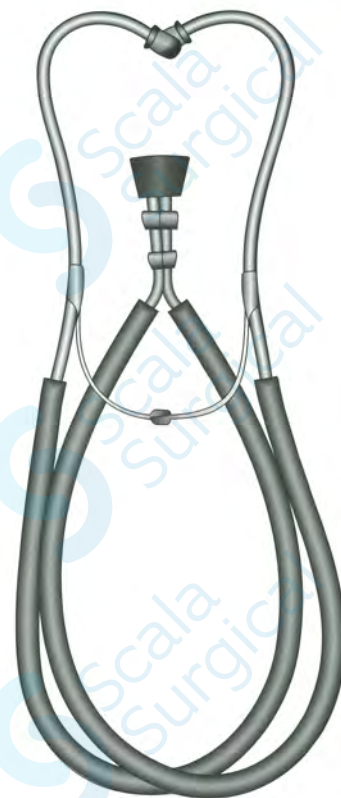

Ford Bowles
S-01-0006

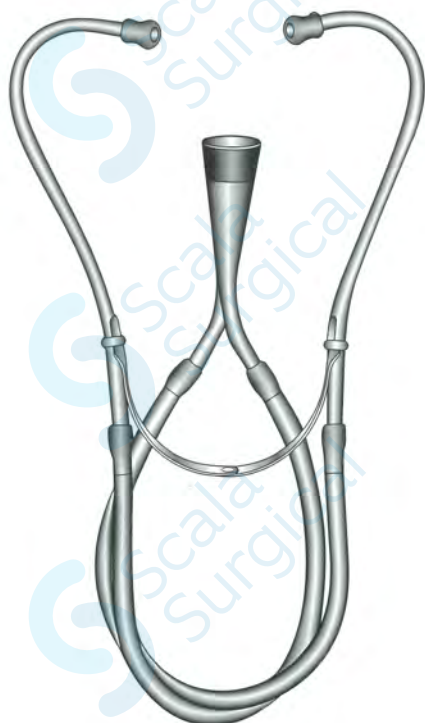

Skinner
S-01-0007



Dual-head
S-01-0008
Light Weight
Littmann Type



Nurses
S-01-0009
Single Chest piece
Light Weight

Foetal Stethoscopes & Calipers



Pinard
S-01-0021
Foetal, Aluminum



Pinard
S-01-0022
Foetal, Wooden



Pinard
S-01-0023
Foetal, Plastic

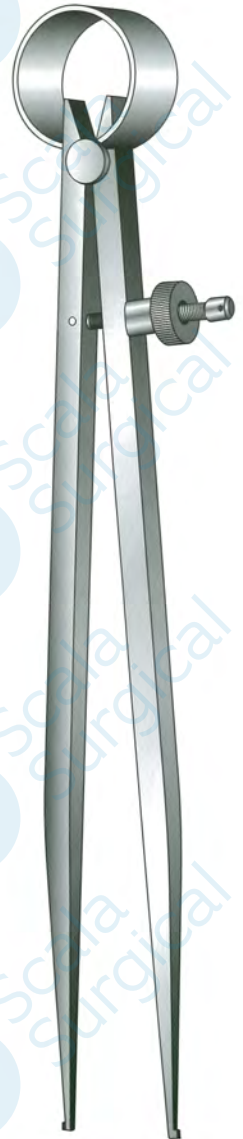

Measuring Caliper
S-02-0043
25 cm / 10"

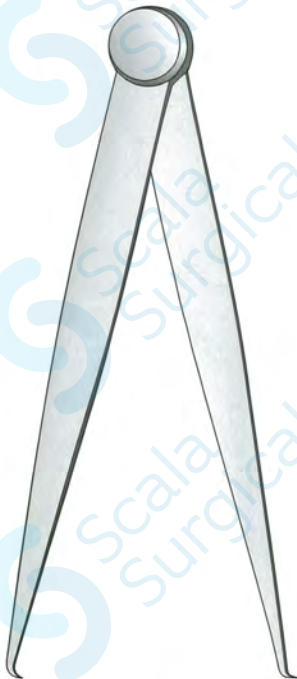

Sweet Discriminator
S-02-0040
Graduated 1-6 cms



Albee
S-02-0042
Bone Graft Caliper

Goniometers

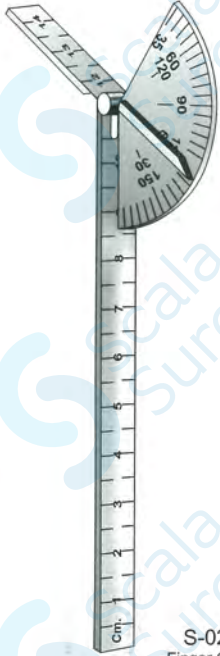

S-02-0050
Finger Goniometer

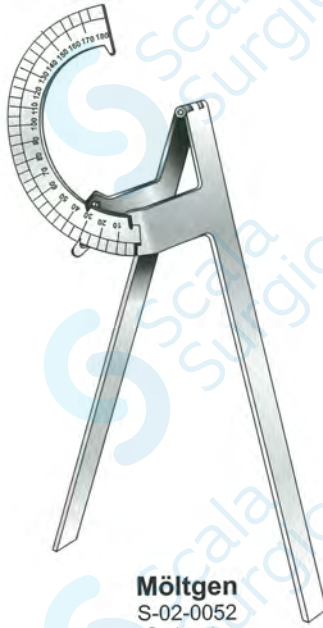

Möltgen
S-02-0052
Goniometer

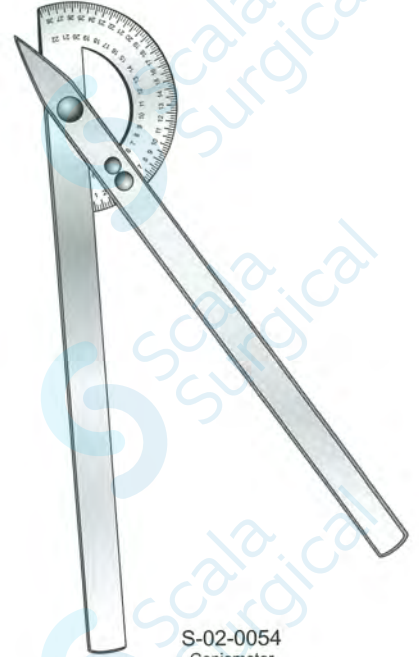

S-02-0054
Goniometer



S-02-0056
13½", 34 cm
Goniometer for measuring angles,
diameters and body cavities

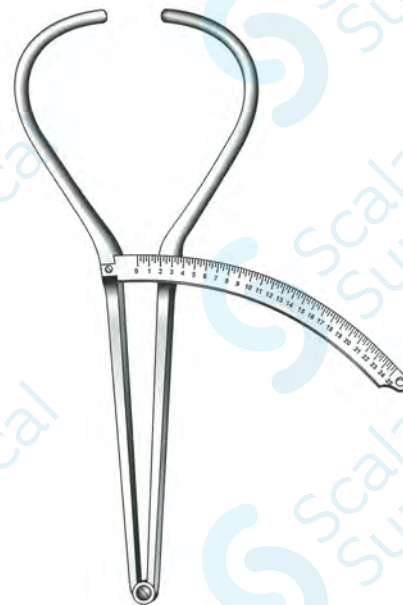

Bertillon
S-02-0058
12¾", 32 cm
Caliper for measuring the head

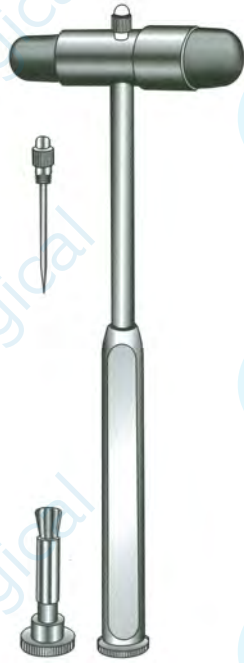

Buck
S-03-2500



Buck
S-03-2502
Telescopic



Berliner Percussor
S-03-2504
7 1/2", 20 cm



Hurst Percussor
S-03-2505
Short Model

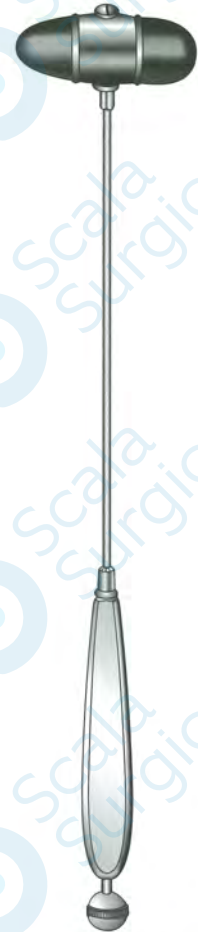

Hurst Percussor
S-03-2506
Long Model

Percussion Hammers



Dejerine
S-03-2512
Without Pin



Dejerine
S-03-2513
With Pin



Mcgill
S-03-2517
Neurological



Taylor
S-03-2519



Troemner
S-03-2521



Wartenberg
S-03-2523
Pin Wheel

Percussion Hammers



Queen Square
S-03-2525
Nylon Handle



Queen Square Pattern
S-03-2527
Telescopic



Rubber Ring
S-03-2529
For Queen Square

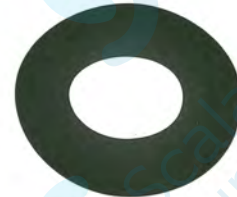

Rubber Ring
S-03-2531
For Babinsky



Babinski
S-03-2533



Vernon
S-03-2535
Ball Head



Vernon
S-03-2537
Disc Head

Scalpel Handles



B.P Handle
S-04-0100
No.3



B.P Handle
S-04-0101
No.3L



B.P Handle
S-04-0102
No.7



B.P Handle
S-04-0103
No.9



B.P Handle
S-04-0104
No.4



B.P Handle
S-04-0105
No.4L



B.P Handle
S-04-0106
No.5



Barron Handle
S-04-0107



Blade Removing Forceps
S-04-0109
6", 15 cm
Screw Joint

Swann-Morton Blade and Handles



Swan Morton
S-04-0111
Handle No. 4L



Swan Morton
S-04-0112
Handle No. 5



Swan Morton
S-04-0113
Handle No. 4



Swan Morton
S-04-0114
Handle No. 9



Swan Morton
S-04-0115
Handle No. 3

Swann-Morton Blade and Handles



Swan Morton
S-04-0116
Handle No. 3L

All Items Shown actual size
Swan Morton Blades

Amputation & Knives Bistouries



Liston

S-05-0117 10 cm Blade
S-05-0118 17 cm Blade
S-05-0119 20 cm Blade
Amputation knife



Catlin

S-05-0120 16 cm Blade
S-05-0121 20 cm Blade
Amputation knife



Langenbeck

S-05-0122
12 cm Blade



Bistoury
S-05-0125
Sharp, Curved



Bistoury
S-05-0126
Blunt, Curved



Bistoury
S-05-0127
Blunt, Straight



Sommerland
S-05-0130



Eckhoff
S-05-0133



S-05-0135
Nib Only



Solid Forged Scalpel



S-05-0141
25 mm



S-05-0142
30 mm



S-05-0143
35 mm



S-05-0144
40 mm



S-05-0145
45 mm



S-05-0146
50 mm

Dissecting Instruments



Watch Maker
S-06-0250
No.3



Watch Maker
S-06-0251
No.4



Watch Maker
S-06-0252
No.5



Watch Maker
S-06-0253
No.5as



Watch Maker
S-06-0254
No.7



S-06-0256
Small Needle
Brass Handle



S-06-0258
Bent Needle
Angled Sharp
Aluminium



S-06-0259
Bent Seeker
Angled Blunt
Aluminium



S-06-0260
Needle Straight
Aluminium



S-06-0261
Seeker Straight
Aluminium



Seekers Angled
S-06-0262
Bent Needle
Plastic Handle



Arrow Needles
S-06-0263
Plastic Handle
Bent Seeker



Needles
S-06-0264
Plastic Handle
Straight Needle



Seekers Straight
S-06-0265
Plastic Handle
Straight Seeker



Blow Pipe
S-06-0268



Chain Hook
S-06-0270

Dissecting Instruments



Section Lifter
S-06-0273



Magnifier
S-06-0275



Dropper (Pipette)
S-06-0277



Chattaway
S-06-0279
Spatula

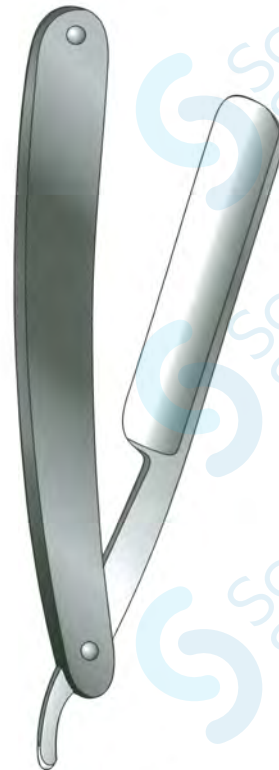

Section Razor
S-06-0281



Stitch

- S-07-0199 5", 13 cm
Open Flat
- S-07-0200 4", 10 cm
- S-07-0201 4½", 11.5 cm
- S-07-0202 5", 13 cm
- S-07-0203 5½", 14 cm
- S-07-0204 6", 15 cm
- S-07-0205 7", 18 cm
- S-07-0206 8", 20 cm
- S-07-0207 9", 23 cm
Sharp / Sharp, Straight



Stitch

- S-07-0208 4", 10 cm
- S-07-0209 4½", 11.5 cm
- S-07-0210 5", 13 cm
- S-07-0211 5½", 14 cm
- S-07-0212 6", 15 cm
- S-07-0213 7", 18 cm
- S-07-0214 8", 20 cm
- S-07-0215 9", 23 cm
Sharp / Sharp, Curved



Dressing

- S-07-0216 4", 10 cm
- S-07-0217 4½", 11.5 cm
- S-07-0218 5", 13 cm
- S-07-0219 5½", 14 cm
- S-07-0220 6", 15 cm
- S-07-0221 7", 18 cm
- S-07-0222 8", 20 cm
- S-07-0223 9", 23 cm
Sharp / Blunt, Straight



Dressing

- S-07-0224 4", 10 cm
- S-07-0225 4½", 11.5 cm
- S-07-0226 5", 13 cm
- S-07-0227 5½", 14 cm
- S-07-0228 6", 15 cm
- S-07-0229 7", 18 cm
- S-07-0230 8", 20 cm
- S-07-0231 9", 23 cm
Sharp / Blunt", Curved

Scissors



Dressing
 S-07-0232 4", 10 cm
 S-07-0233 4½", 11.5 cm
 S-07-0234 5", 13 cm
 S-07-0235 5½", 14 cm
 S-07-0236 6", 15 cm
 S-07-0237 7", 18 cm
 S-07-0238 8", 20 cm
 S-07-0239 9", 23 cm
 Blunt / Blunt, Straight



Dressing
 S-07-0240 4", 10 cm
 S-07-0241 4½", 11.5 cm
 S-07-0242 5", 13 cm
 S-07-0243 5½", 14 cm
 S-07-0244 6", 15 cm
 S-07-0245 7", 18 cm
 S-07-0246 8", 20 cm
 S-07-0247 9", 23 cm
 S-07-0248 12", 30.5 cm
 S-07-0249 14", 35.5 cm
 Blunt / Blunt, Curved

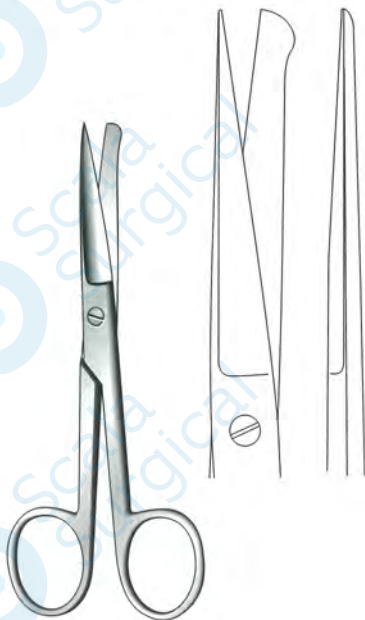

Dressing
 S-07-0251
 Sharp, Probe Point
 5", 13 cm
 Straight

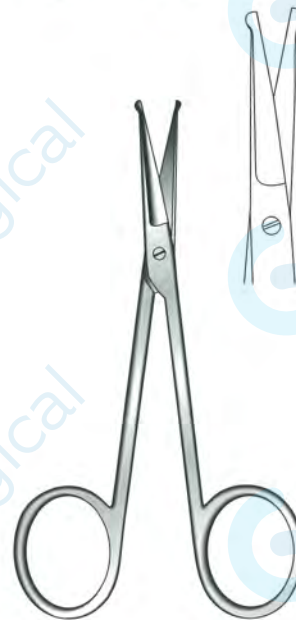

Blood Vessel Scissors
 S-07-0252
 Both Probe Points
 5", 13 cm
 Straight

Scissors



Dressing Scissor
S-07-0253
4 1/4", 11.5 cm
One Sharp, Probe Points
Straight, Open Shanks



Dressing / Nurses
S-07-0254
Sharp/Blunt, with Clip
5", 13 cm
Straight



Nurses Chains
S-07-0255
22", 56 cm



Dressing
S-07-0260 4 1/2", 11.5 cm S-07-0263
S-07-0261 5", 13 cm S-07-0264
S-07-0262 6", 15 cm
Straight Open Shanks Curved

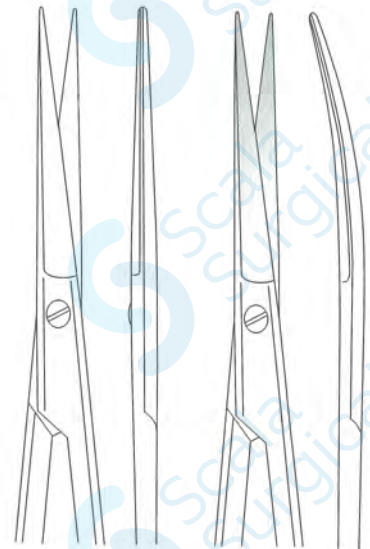

Scissors

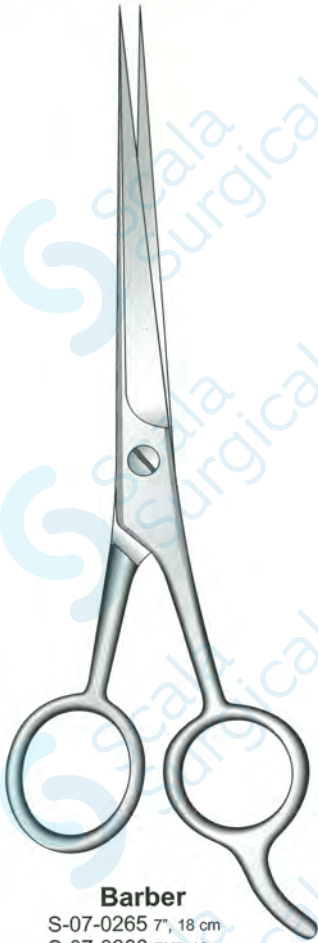

Barber

S-07-0265 7", 18 cm
S-07-0266 7½", 19 cm

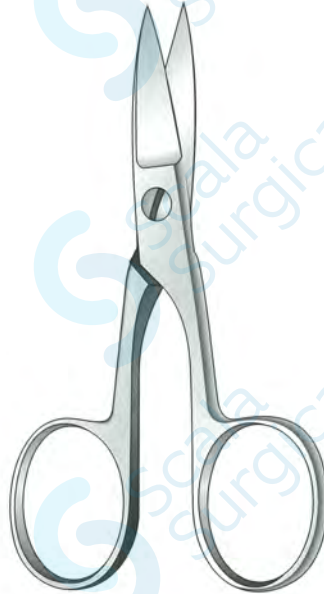

Nail

S-07-0267 Straight
S-07-0268 Curved
3½", 9 cm



Cuticle Scissors

S-07-0269 Straight
S-07-0270 Curved
3½", 9 cm

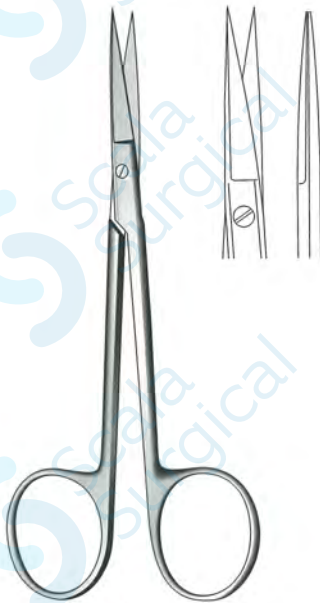

Iris

S-07-0281 4", 10 cm
S-07-0282 4½", 11.5 cm
S-07-0283 5", 13 cm
Straight



Iris

S-07-0284 4", 10 cm
S-07-0285 4½", 11.5 cm
S-07-0286 5", 13 cm
Curved

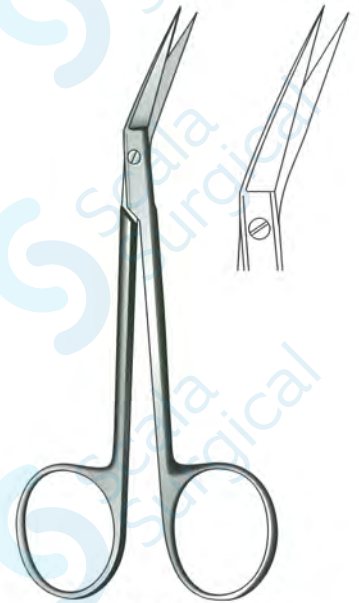

Iris

S-07-0288
4½", 11.5 cm
Angles to side

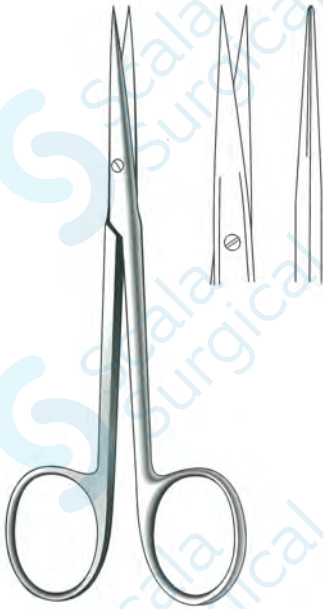

Kilner
S-07-0289
4½", 11.5 cm
Straight

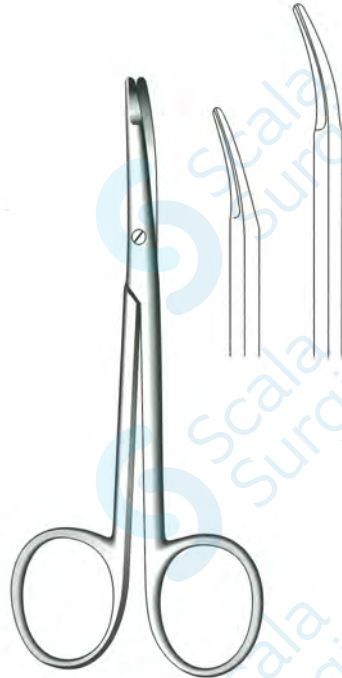

Kilner
S-07-0290
With Flat Tips, Curved
4½", 11.5 cm

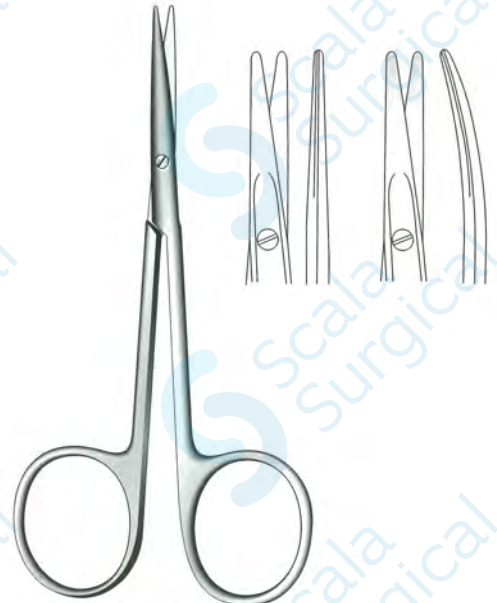

Strabismus
S-07-0291 Straight
S-07-0292 Curved
4½" 11.5 cm

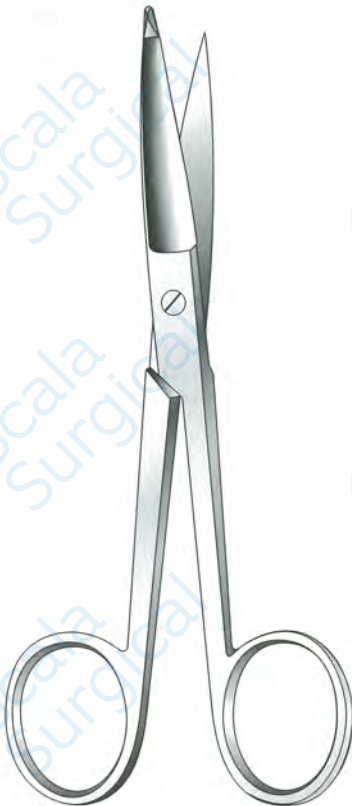

Knowle Bandage
S-07-0293
5½", 14 cm



Lister Bandage
S-07-0294 4½", 11.5 cm
S-07-0295 5½", 14 cm
S-07-0296 7¼", 18.5 cm
S-07-0297 8", 20 cm
S-07-0298 9", 23 cm

Scissors



Mayo

- S-07-0300 5/8", 14 cm
 - S-07-0301 6 1/2", 16.5 cm
 - S-07-0302 7 1/2", 19 cm
 - S-07-0303 8 1/2", 21.5 cm
 - S-07-0304 9", 23 cm
- Straight

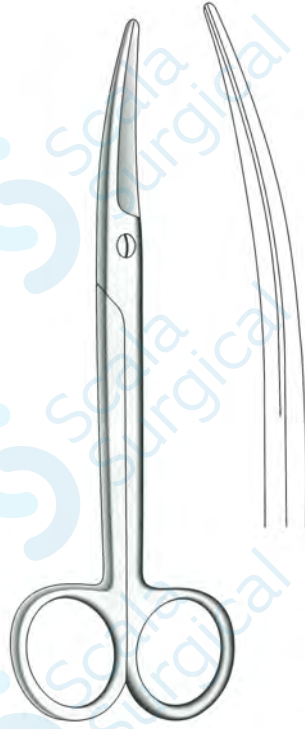

Mayo

- S-07-0305 5/8", 14 cm
 - S-07-0306 6 1/2", 16.5 cm
 - S-07-0307 7 1/2", 19 cm
 - S-07-0308 8 1/2", 21.5 cm
 - S-07-0309 9", 23 cm
- Curved

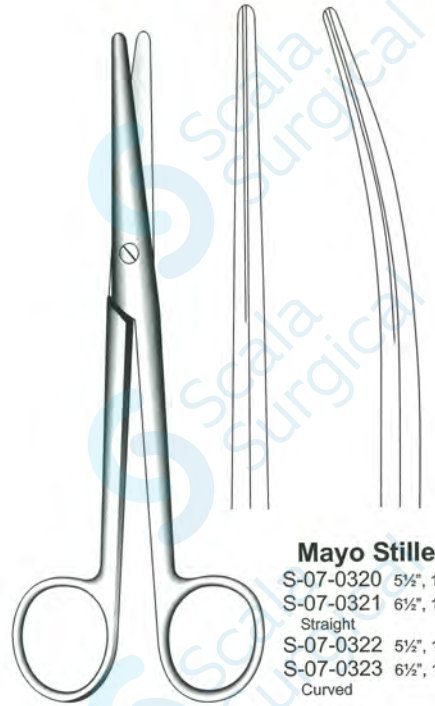

Mayo Stille

- S-07-0320 5/8", 14 cm
 - S-07-0321 6 1/2", 16.5 cm
- Straight
- S-07-0322 5/8", 14 cm
 - S-07-0323 6 1/2", 16.5 cm
- Curved

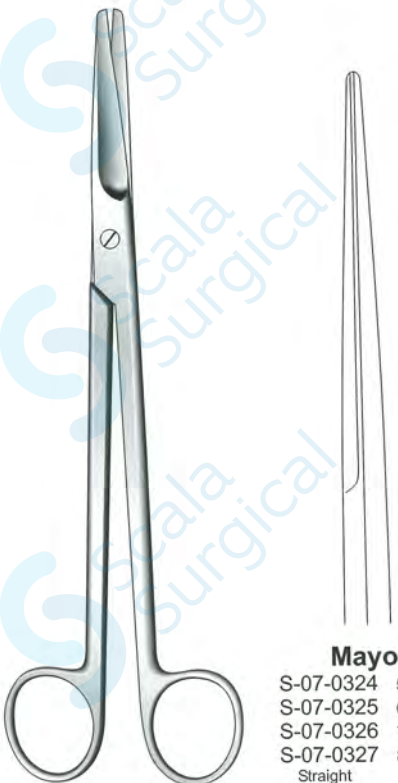

Mayo Harrington

- | | |
|---------------------------|-----------|
| S-07-0324 5/8", 14 cm | S-07-0328 |
| S-07-0325 6 1/2", 16.5 cm | S-07-0329 |
| S-07-0326 7 1/2", 19 cm | S-07-3330 |
| S-07-0327 8 1/2", 21.5 cm | S-07-0331 |
- Straight Curved

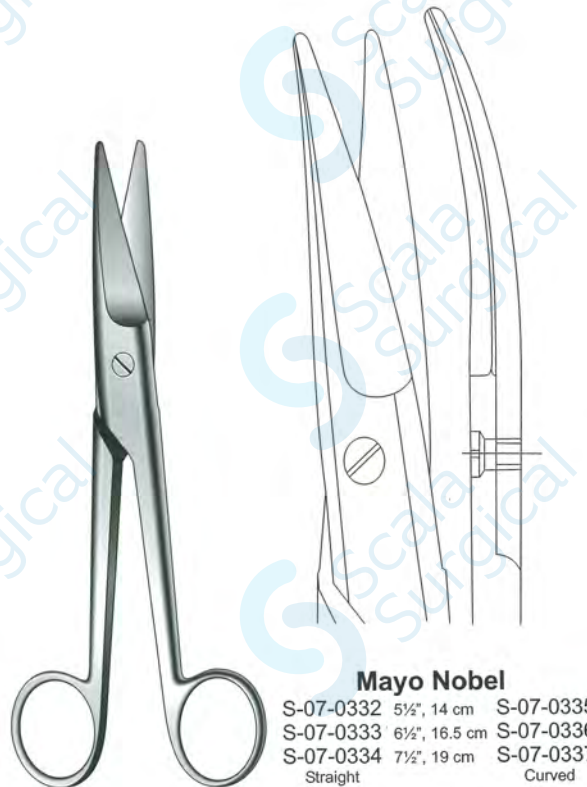

Mayo Nobel

- | | |
|---------------------------|-----------|
| S-07-0332 5/8", 14 cm | S-07-0335 |
| S-07-0333 6 1/2", 16.5 cm | S-07-0336 |
| S-07-0334 7 1/2", 19 cm | S-07-0337 |
- Straight Curved

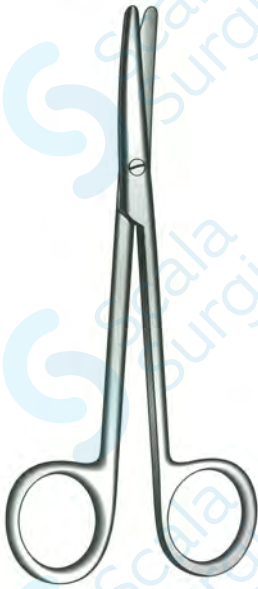

McIndoe

S-07-0340 4½", 11.5 cm
S-07-0341 7½", 19 cm
Curved

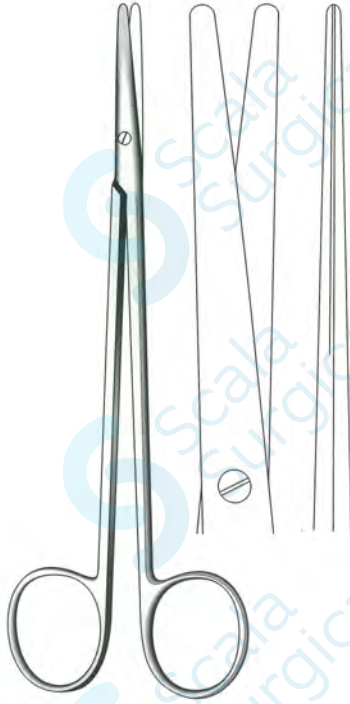

Metzenbaum

S-07-0350 5½", 14 cm
S-07-0351 6½", 16.5 cm
S-07-0352 7½", 19 cm
S-07-0353 8½", 21.5 cm
S-07-0354 9½", 24 cm
S-07-0355 10½", 26.5 cm
S-07-0356 12", 30.5 cm
S-07-0357 14", 35.5 cm
Straight

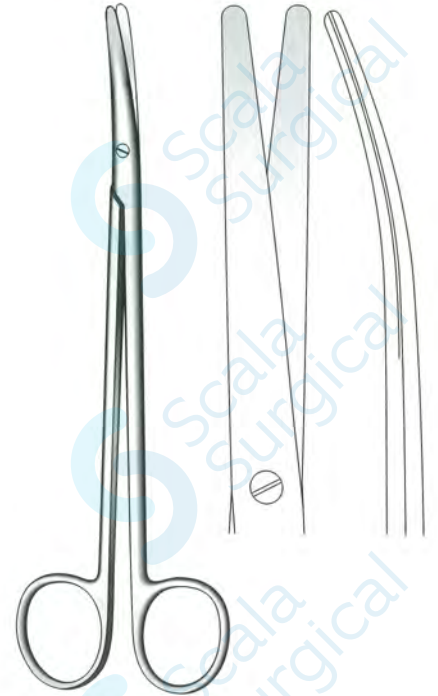

Metzenbaum

S-07-0360 5½", 14 cm
S-07-0361 6½", 16.5 cm
S-07-0362 7½", 19 cm
S-07-0363 8½", 21.5 cm
S-07-0364 9½", 24 cm
S-07-0365 10", 25 cm
S-07-0366 12", 30.5 cm
S-07-0367 14", 35.5 cm
S-07-0368 16", 40.5 cm
Curved

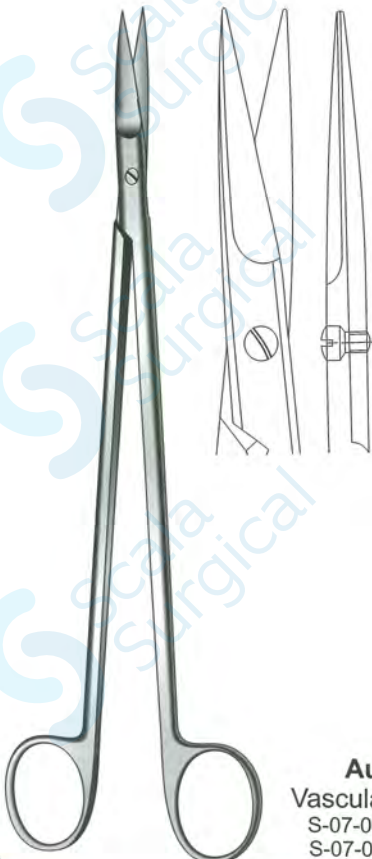

Aufricht

Vascular Scissors

S-07-0369 Straight
S-07-0370 Curved
6", 15 cm

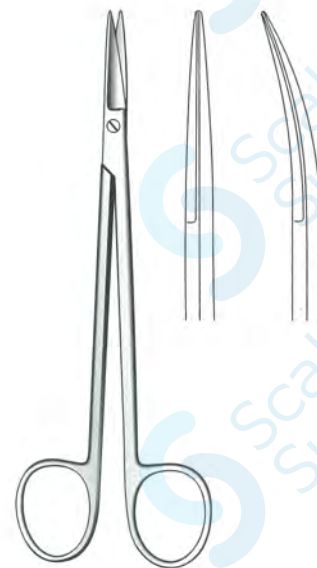

Kelly

S-07-0375 Straight
S-07-0376 Curved
6½", 16.5 cm

Scissors

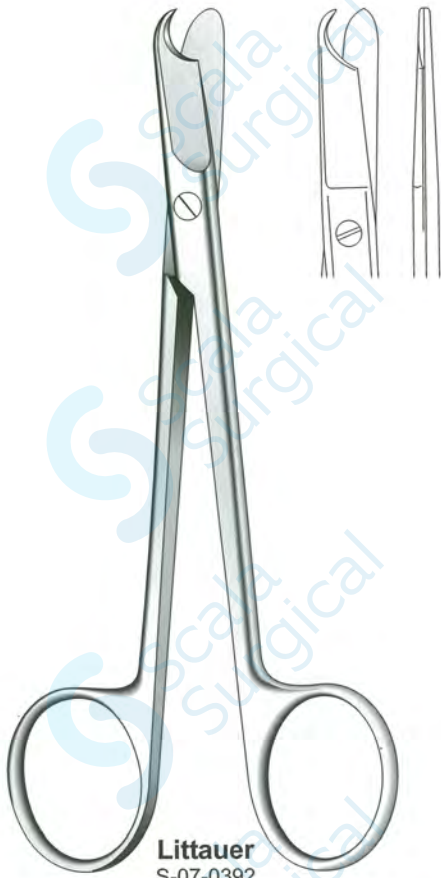

Littauer
S-07-0392
5½" 14 cm
Stitch / Suture

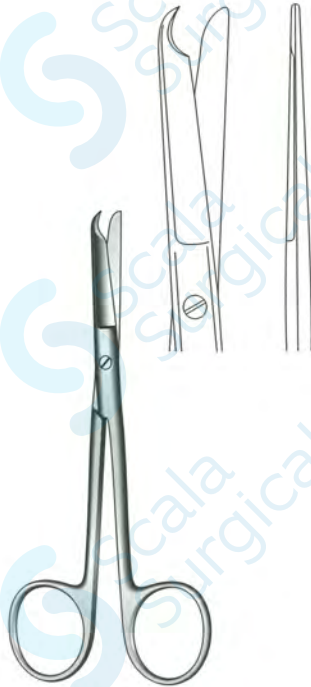

Spencer
S-07-0393 3½", 9 cm
S-07-0394 4½", 11.5 cm
S-07-0395 5", 13 cm
Stitch / Suture



Heath
S-07-0400
6", 15 cm

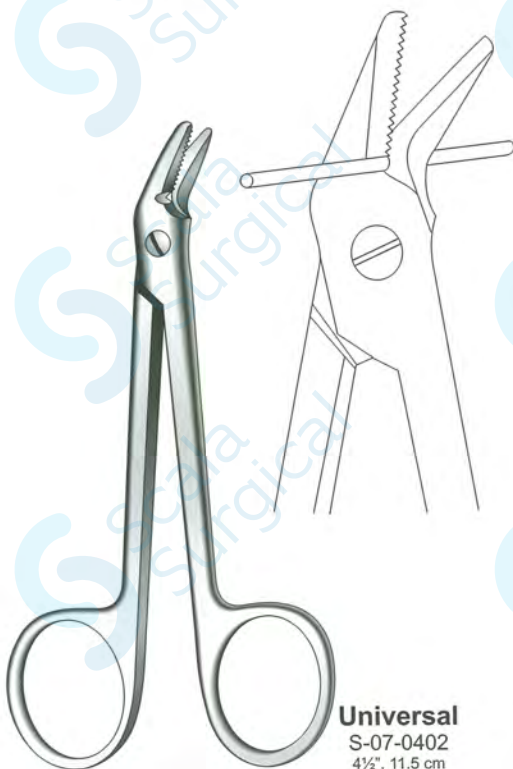

Universal
S-07-0402
4½", 11.5 cm



Cambell
S-07-0404
4", 10 cm

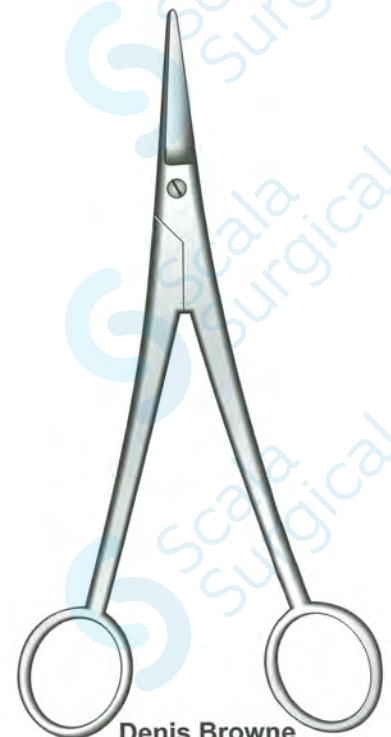

Denis Browne
S-07-0406
6½", 16.5 cm



Fomon
S-07-0407
Blades Serrated
5 3/4", 14.5 cm

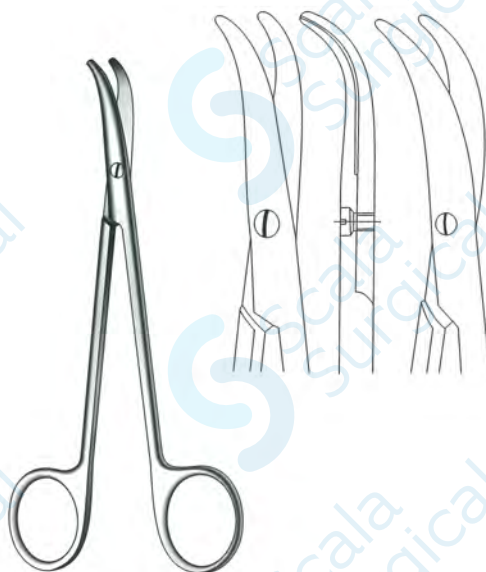

Fomon
Lower Lateral Scissors
S-07-0408 4 1/2", 11.5 cm
S-07-0409 5 1/4", 13.5 cm

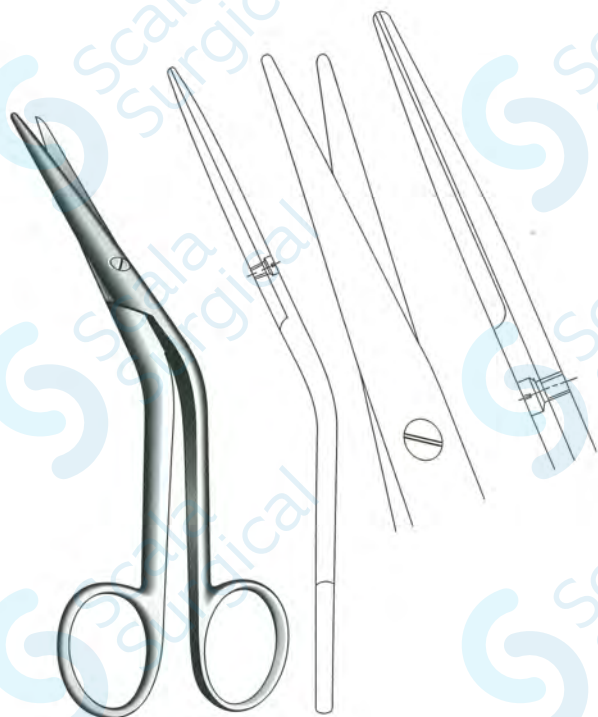

Cottle
S-07-0410
6 1/2", 16.5 cm

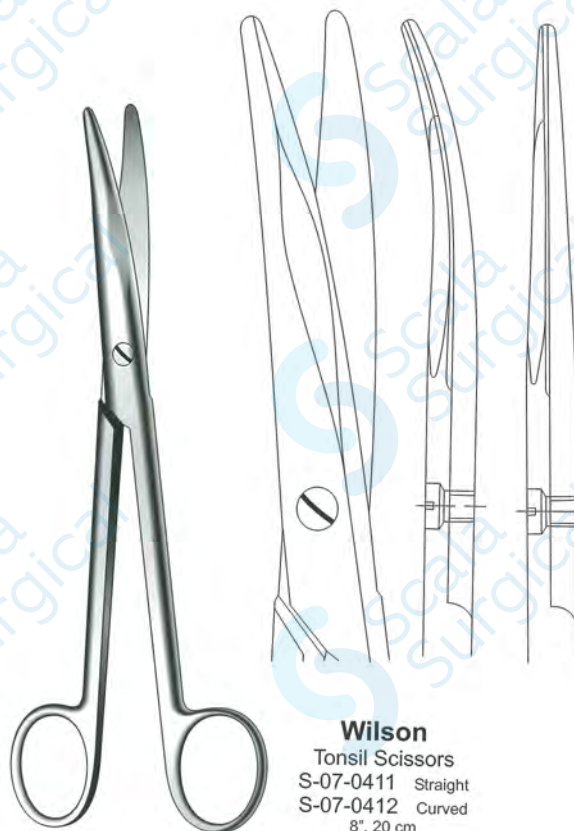

Wilson
Tonsil Scissors
S-07-0411 Straight
S-07-0412 Curved
8", 20 cm

Scissors

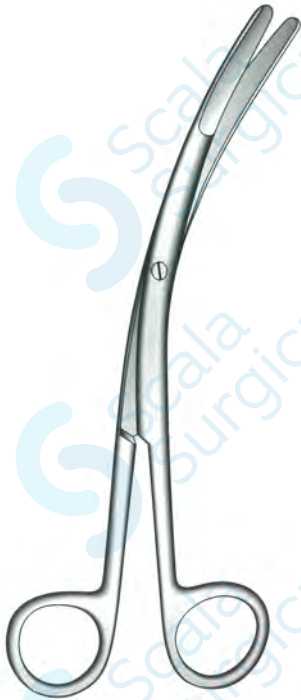

Beckmann
 S-07-0413 6½", 16.5 cm
 S-07-0414 7½", 19 cm
 Lower Blade Serrated

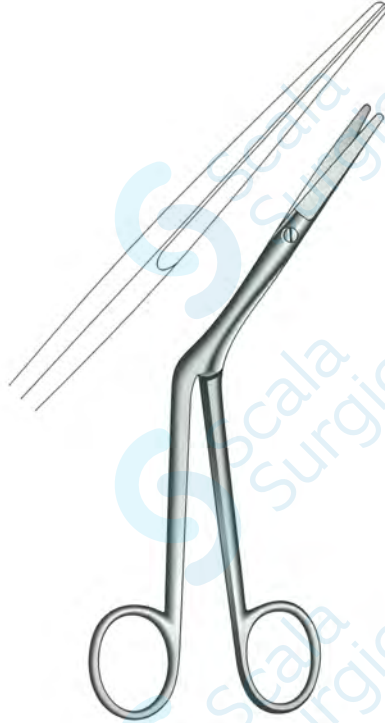

Heymann
 S-07-0418
 7", 18 cm
 Nasal Turbinectomy

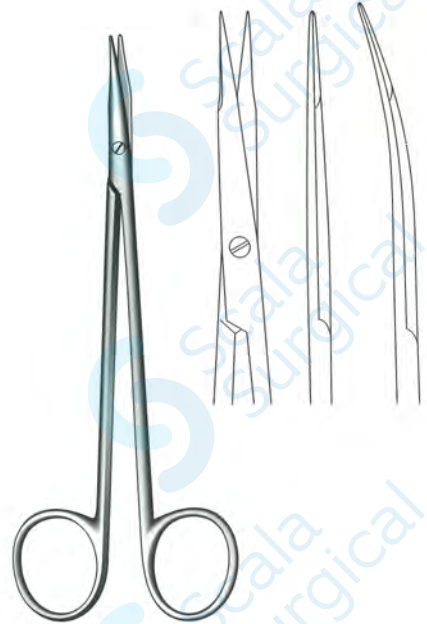

Barsky
 S-07-0419
 6¼", 16 cm
 Nasal Curved On Flat



Fickling
 S-07-0420
 7", 18 cm
 Oral, Angled

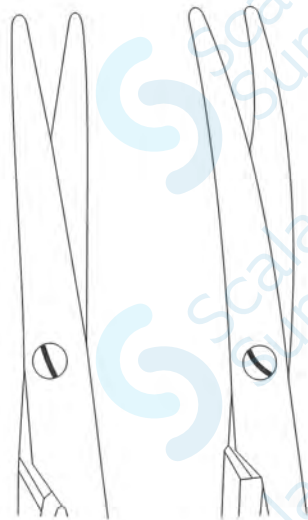

Nelson Metzenbaum (Thoracic)
 S-07-0425 9", 23 cm S-07-0428
 S-07-0426 11", 28 cm S-07-0429
 S-07-0427 14", 35.5 cm S-07-0430
 Straight Curved

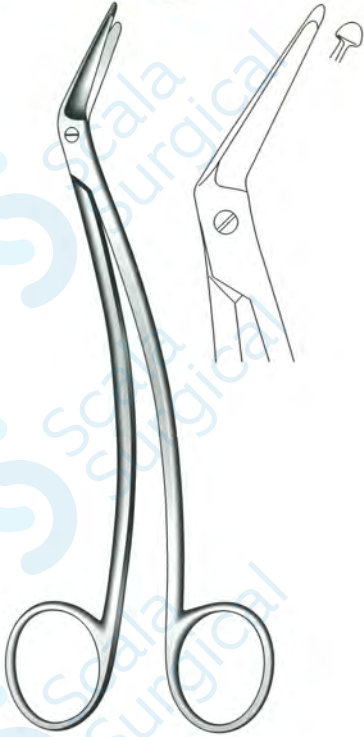

Strully
S-07-0433
7½", 19 cm
Angled



Yankauer
S-07-0435
6¾", 17 cm
Tonsil, Curved



Dean
S-07-0437
6½", 16.5 cm
Tonsil

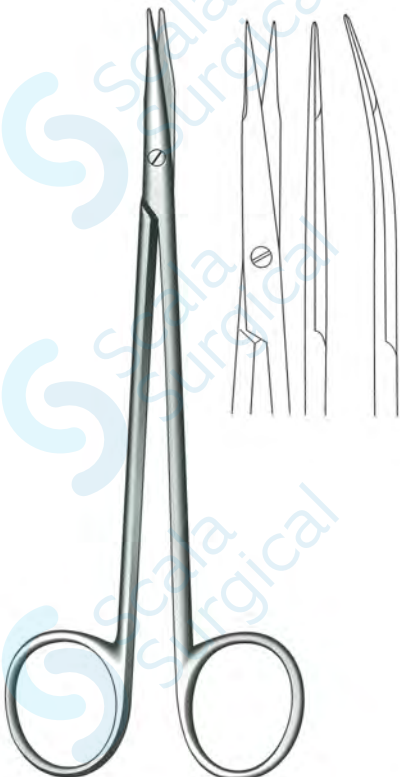

Reynolds
S-07-0438
5½", 14 cm
Curved

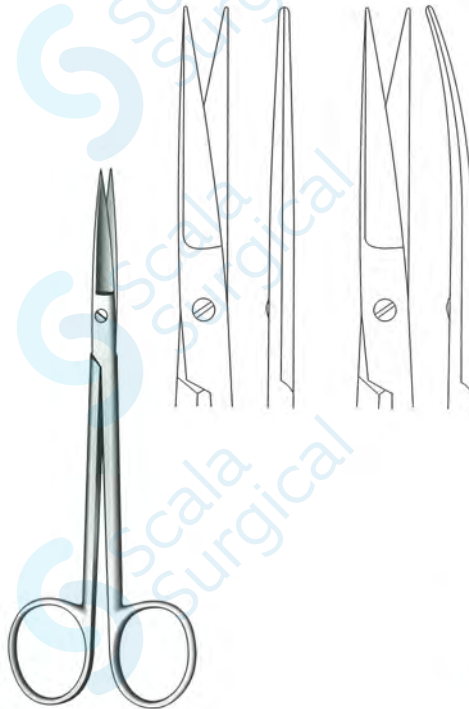

Joseph
S-07-0439 Straight
S-07-0440 Curved
5¾", 14.5 cm

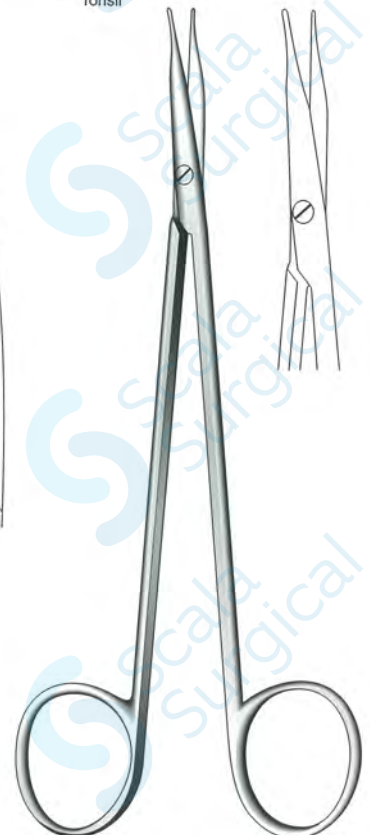

Jameson
S-07-0441 Straight
S-07-0442 Curved
6", 15 cm

Scissors



Abel
S-07-0445 Curved
S-07-0446 Straight
12½", 31.5 cm



Goligher
S-07-0443
12", 30.5 cm
Curved



Lloyd-Davies
S-07-0447 Straight, 10", 25 cm
S-07-0448 Curved, 10", 25 cm
S-07-0449 Curved, 14", 35.5 cm



Goligher
S-07-0444
12", 30.5 cm
Straight

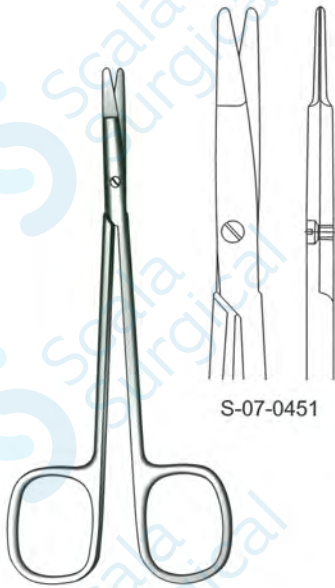

S-07-0451

Ragnell
5¼", 13.5 cm
Special flat points for dissecting
and undermining the skin

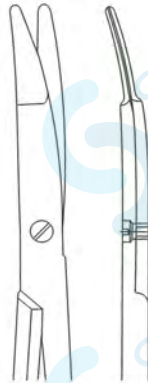

S-07-0452



Knapp
S-07-0453
4½", 11.5 cm
Straight, Blackened



Knapp
S-07-0454
4½", 11.5 cm
Curved, Blackened

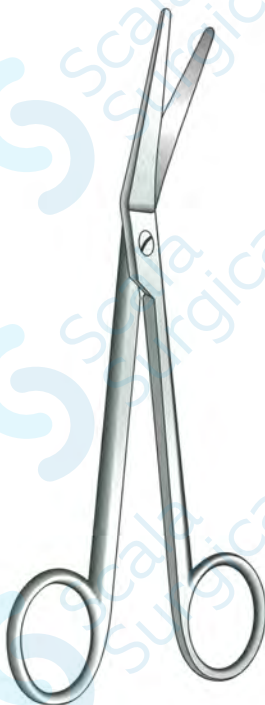

Cairns Neuro
S-07-0455

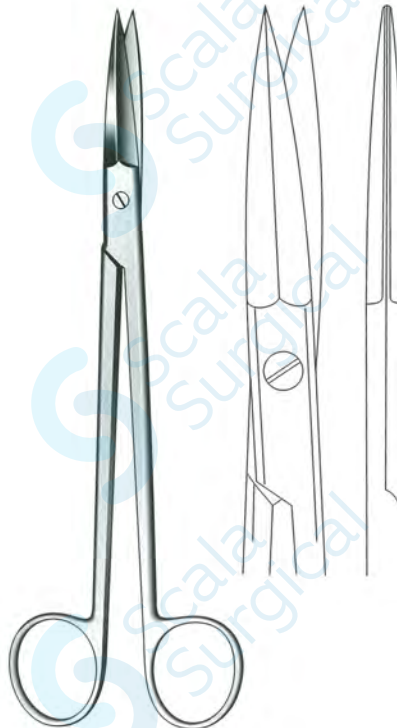

McIndoe Neuro
S-07-0456
7½", 19 cm
Triangular Blade

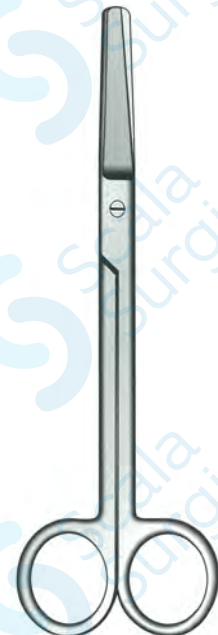

Carless
Light weight
S-07-0457 6½", 16.5 cm S-07-0459
S-07-0458 8½", 21.5 cm S-07-0460
Straight Curved

Scissors

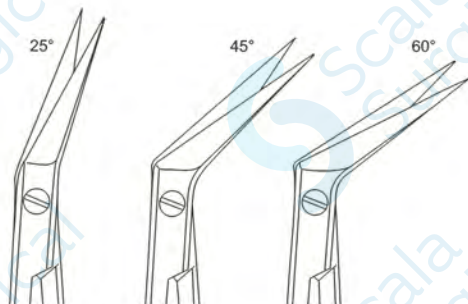

Pott
 S-07-0461 25°
 S-07-0462 45°
 S-07-0463 60°
 Angled to Side
 7½", 19 cm

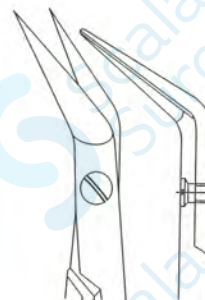
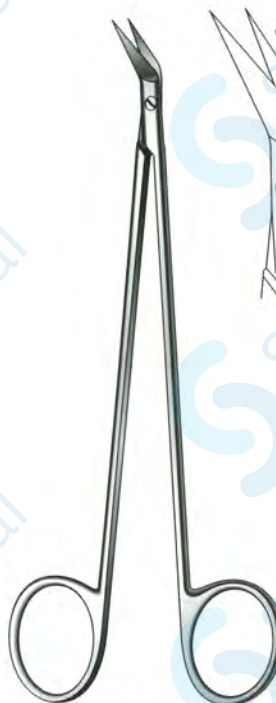

Pott Smith
 S-07-0464
 7½", 19 cm
 Angled on Flat

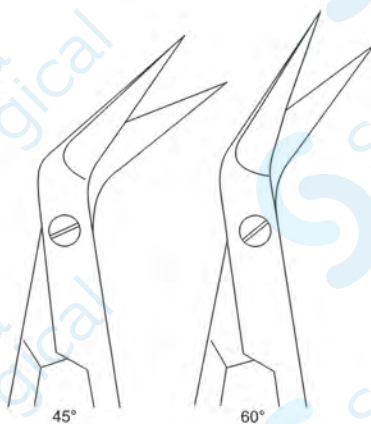
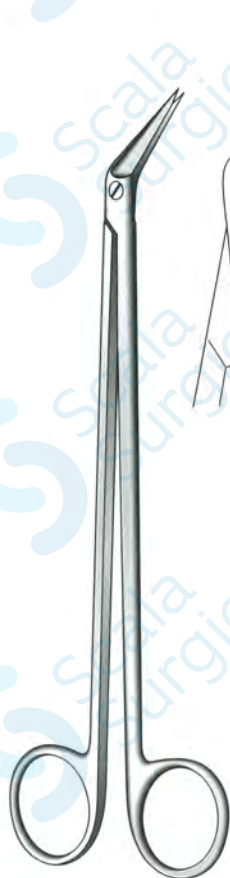

Debakey
 S-07-0465 45°
 S-07-0466 60°
 6", 15 cm
 Angled to Side
 Vessel Scissors



Debakey
 S-07-0467
 6", 15 cm
 Off Set- S Shaped



Richter
S-07-0468 5", 13 cm
S-07-0469 5½", 14 cm
Angled to side

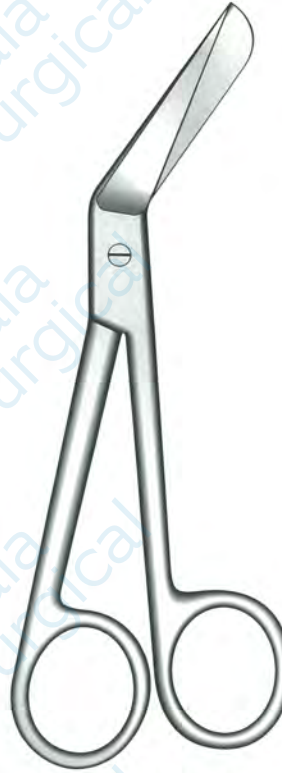

Lawson Tait
S-07-0470 5", 13 cm
S-07-0472 5½", 14 cm
Episiotomy

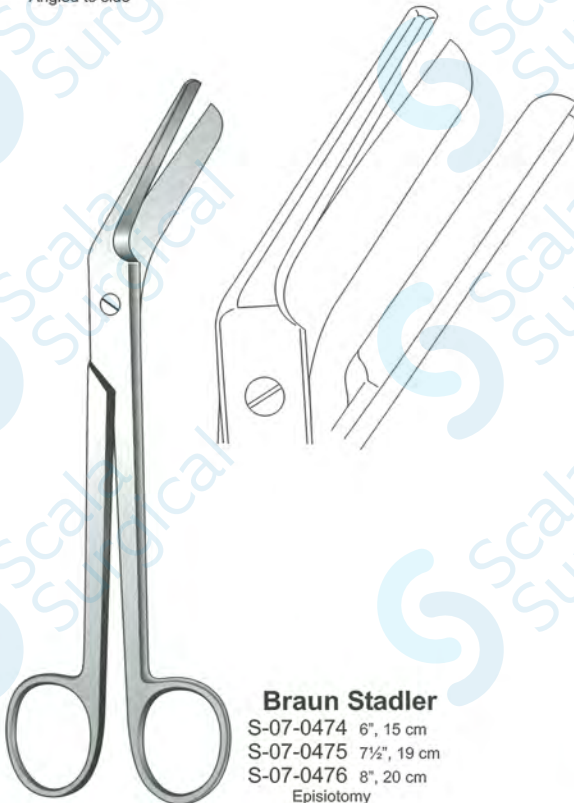

Braun Stadler
S-07-0474 6", 15 cm
S-07-0475 7½", 19 cm
S-07-0476 8", 20 cm
Episiotomy

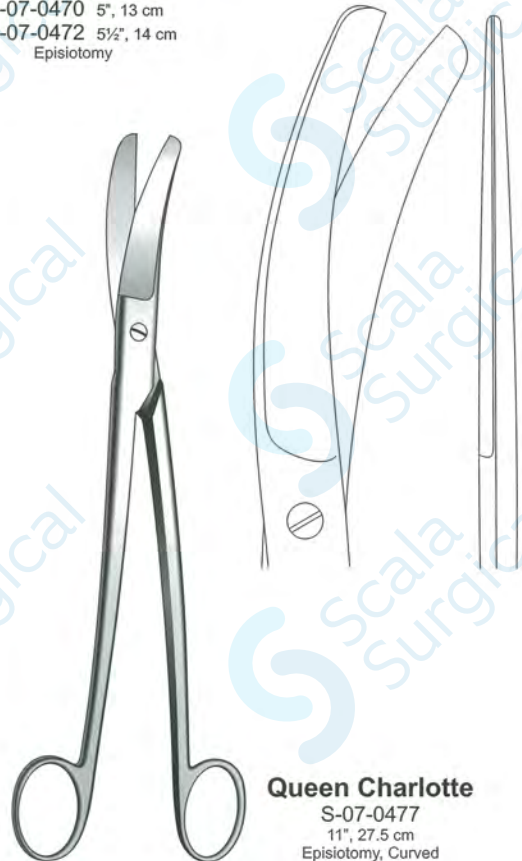

Queen Charlotte
S-07-0477
11", 27.5 cm
Episiotomy, Curved

Scissors

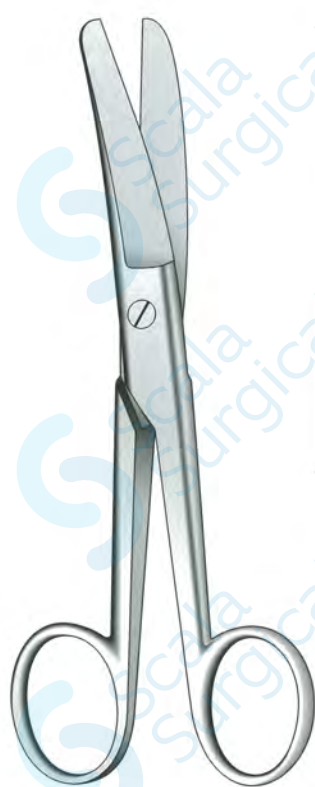

Doyen

S-07-0478 6 3/4", 17 cm S-07-0480
 S-07-0479 8", 20 cm S-07-0481
 Straight Uterine Curved



Fergusson

S-07-0483 Straight
 S-07-0484 Angled on flat
 S-07-0485 Angled to side
 8 1/4", 21 cm
 Uterine



Sims

Uterine
 S-07-0488 S-07-0490 S-07-0492 8" 20 cm
 S-07-0489 S-07-0491 S-07-0493 9" 23 cm
 Straight Curved Angled to Side



Vant

S-07-0494
 9 1/2" 24 cm
 Uterine



Umbilical Cord
S-07-0500
4½", 11.5 cm

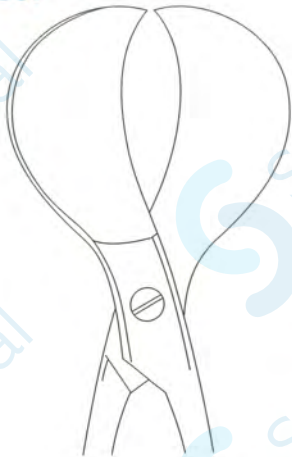

Cord Clamp Cutter
S-07-0501
4½", 12 cm

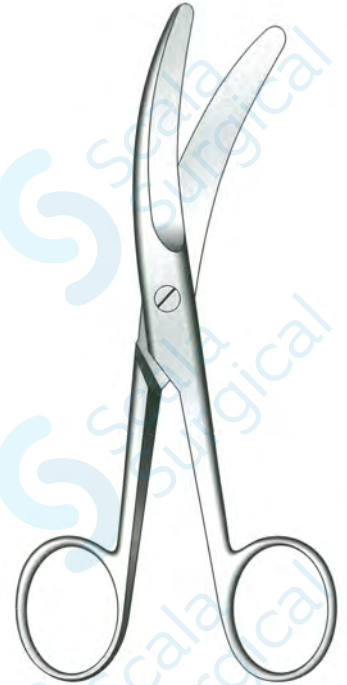

Busch
S-07-0502 Straight
S-07-0503 Curved
6¼", 16 cm



Gauze
S-07-0508 Standard
S-07-0509 One Large Bow
8¾", 21 cm

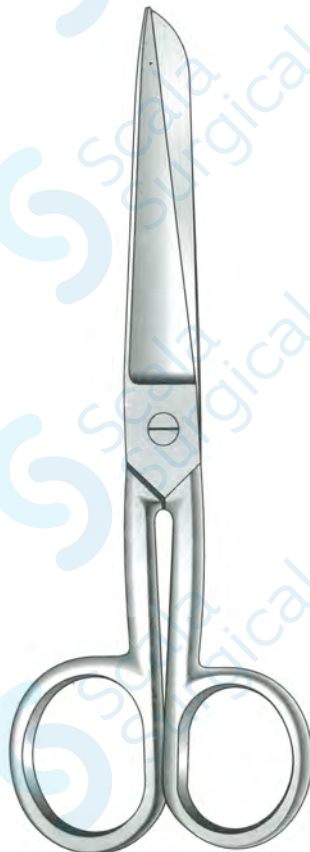

Ward
S-07-0510
8¾", 21 cm

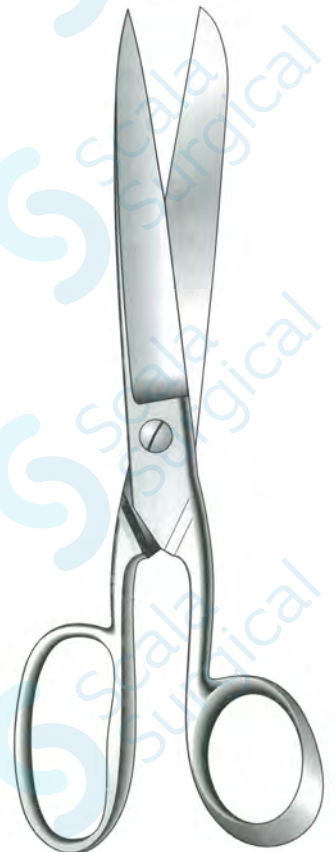

Smith
S-07-0511
8", 20 cm

Scissors



Counter / Taylor

- S-07-0512 7", 18 cm
 - S-07-0513 8", 20 cm
 - S-07-0514 9", 23 cm
 - S-07-0515 10", 25.5 cm
 - S-07-0516 12", 30.5 cm
- Black Bows



Universal

- S-07-0520 5½", 14 cm
 - S-07-0521 7½", 19 cm
- Tough Cut (Plastic Handle)
(Available in Black, Yellow, Green, Blue & White)



- Utility**
S-07-0523
7", 18 cm
Angled Blade
(Plastic Handle)



- Resano**
S-07-0540
10", 25.5 cm

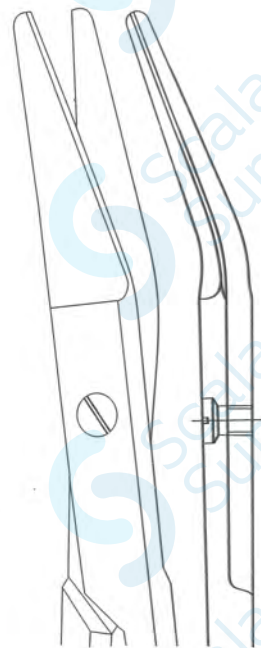

Tungsten Carbide Jaws Scissors

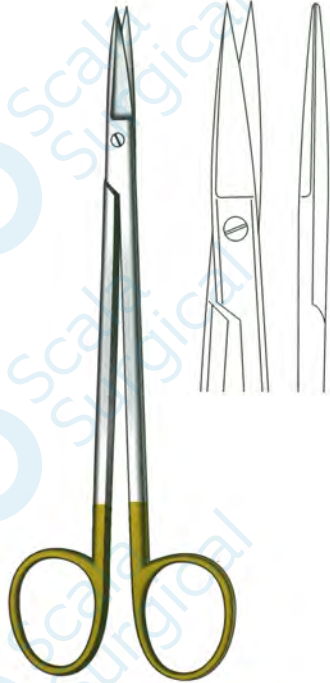

Adson (Kelly)

S-70-0590 Straight
S-70-0591 Curved
6½", 16.5 cm

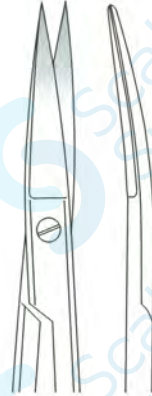

Burns Plaster Shears

S-70-0595
7", 18 cm
Curved



Dressing / Stitch

Sharp / Sharp	
S-70-0601 5", 13 cm	S-70-0604
S-70-0602 6", 15 cm	S-70-0605
S-70-0603 7", 18 cm	S-70-0606
Straight	Curved

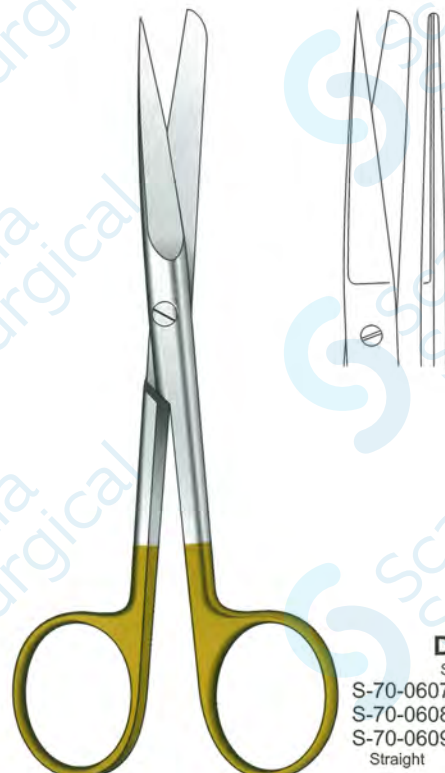

Dressing

Sharp / Blunt	
S-70-0607 5", 13 cm	S-70-0610
S-70-0608 6", 15 cm	S-70-0611
S-70-0609 7", 18 cm	S-70-0612
Straight	Curved

Tungsten Carbide Jaws Scissors



Dressing

Blunt / Blunt

S-70-0615	5", 13 cm	S-70-0618
S-70-0616	6", 15 cm	S-70-0619
S-70-0617	7", 18 cm	S-70-0620
	Straight	Curved

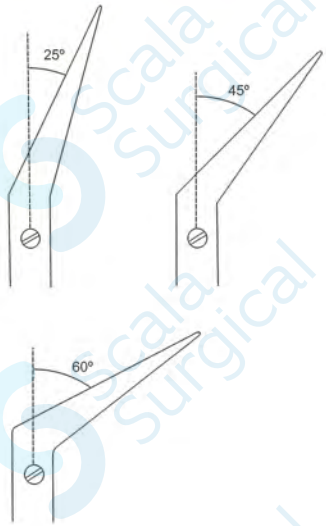
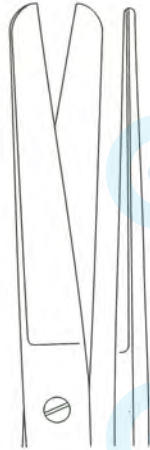

De Bakey

S-70-0622	25°
S-70-0623	45°
S-70-0624	60°
	9", 23 cm
	Vascular



Iris

S-70-0625	Straight
S-70-0626	Curved
	4½", 11.5 cm



Stevens

S-70-0627	Straight
S-70-0628	Curved
	4½", 11.5 cm

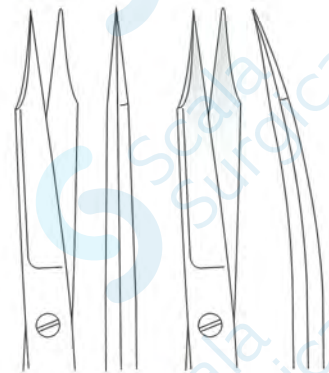



Kilner

S-70-0630 Straight
S-70-0631 Curved
4½", 11.5 cm

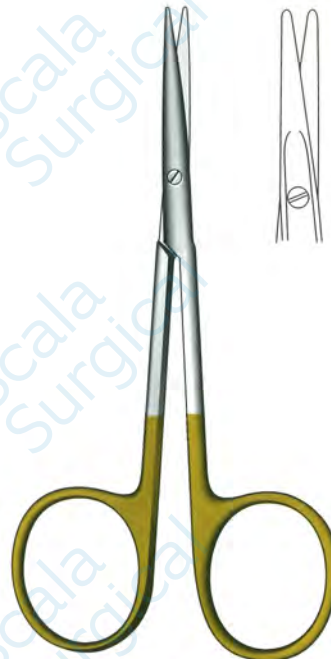
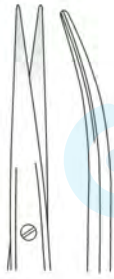

Strabismus

S-70-0635 Straight
S-70-0636 Curved
4½", 11.5 cm

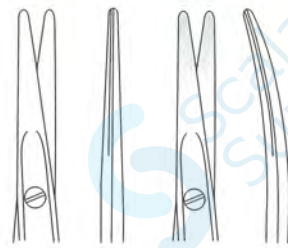

Joseph

S-70-0638 Straight
S-70-0639 Curved
5½", 14 cm

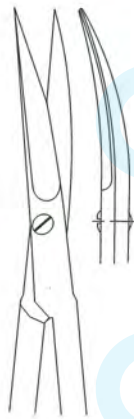

Lister Bandage

S-70-0655 7¼", 18.5 cm
S-70-0656 9", 23 cm

Tungsten Carbide Jaws Scissors



Mayo

S-70-0660	5½", 14 cm	S-70-0670
S-70-0661	6", 15 cm	S-70-0671
S-70-0662	6½", 16.5 cm	S-70-0672
S-70-0663	7", 18 cm	S-70-0673
S-70-0664	8", 20 cm	S-70-0674
S-70-0665	9", 23 cm	S-70-0675
	Straight	Curved

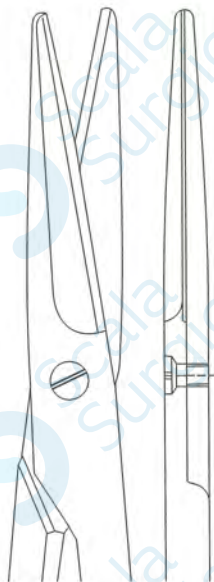

Straight

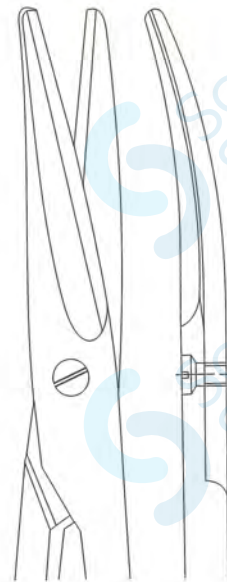

Curved



Sims

S-70-0677
9", 23 cm
Curved

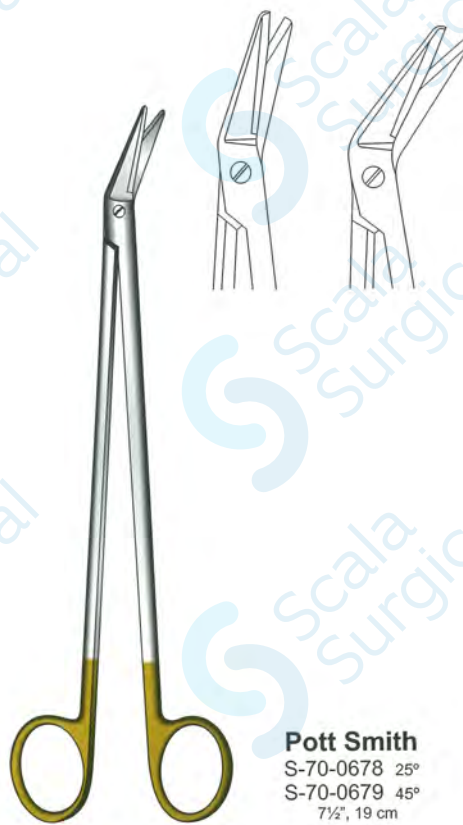
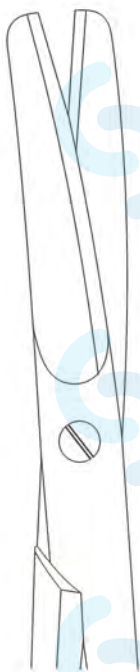

Pott Smith

S-70-0678 25°
S-70-0679 45°
7½", 19 cm



Metzenbaum

S-70-0680	5½", 14 cm	S-70-0690
S-70-0681	6", 15 cm	S-70-0691
S-70-0682	7", 18 cm	S-70-0692
S-70-0683	8", 20 cm	S-70-0693
S-70-0684	9", 23 cm	S-70-0694
S-70-0685	10", 25 cm	S-70-0695
S-70-0686	11", 27.5 cm	S-70-0696
S-70-0687	12", 30.5 cm	S-70-0697
S-70-0688	15", 38 cm	S-70-0698
	Straight	Curved

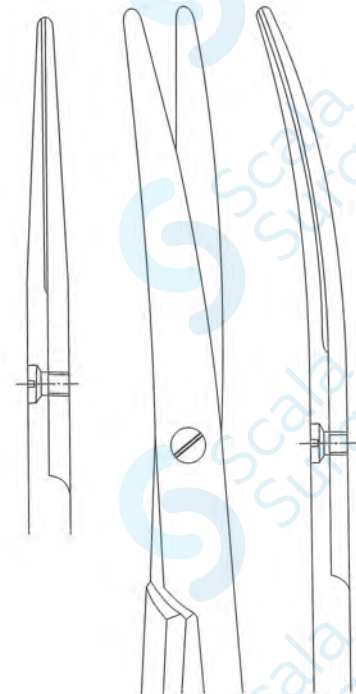
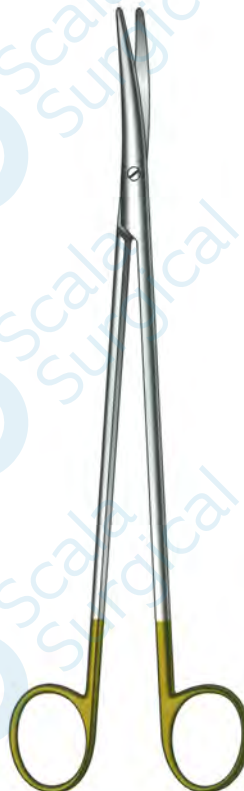
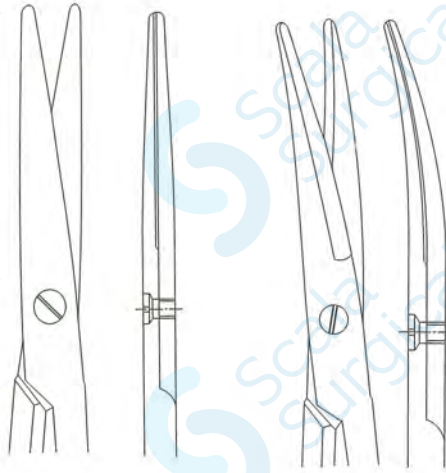

Nelson-Metzenbaum

S-70-0700	9", 23 cm	S-70-0702
S-70-0701	11", 28 cm	S-70-0703
	Straight	Curved

True Cut Scissors



S-70-0750 Straight
S-70-0752 Curved
5", 13 cm
Sharp / Blunt



Iris
S-70-0754 Straight
S-70-0756 Curved
4½", 11.5 cm

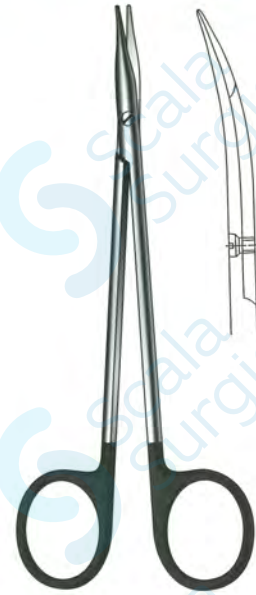

Jameson
S-70-0758
6", 15 cm

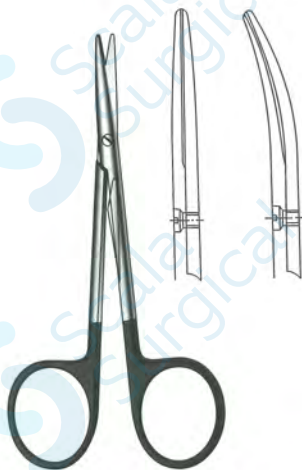

Baby-Metzenbaum
S-70-0760 Straight
S-70-0762 Curved
4½", 11.5 cm



Metzenbaum
S-70-0765 6", 15 cm S-70-0770
S-70-0766 7", 18 cm S-70-0771
S-70-0767 8", 20 cm S-70-0772
Straight Curved

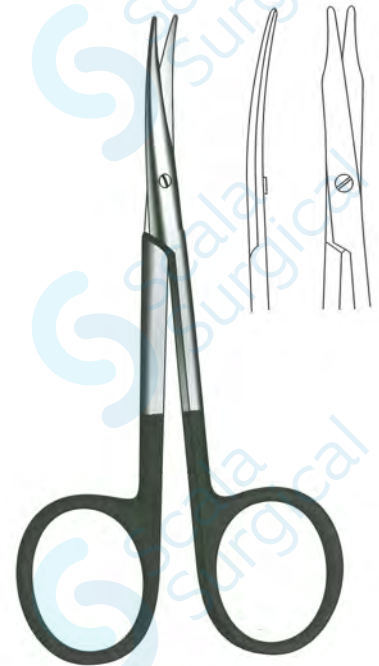

Stevens
S-70-0775
4½", 11.5 cm



Strabismus
S-70-0777 Straight
S-70-0779 Curved
4½", 11.5 cm



Joseph
S-70-0781 Straight
S-70-0783 Curved
6", 15 cm

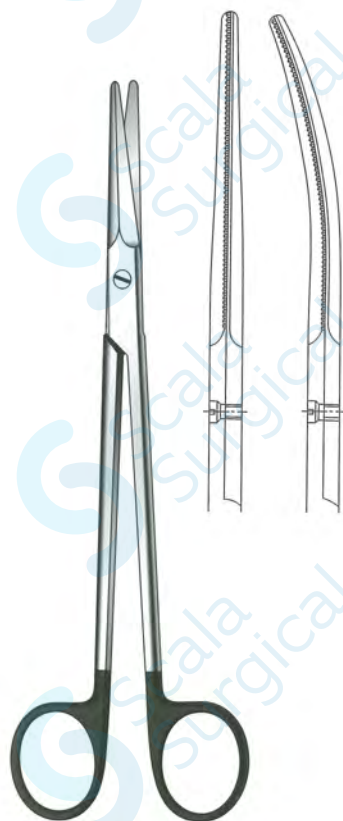
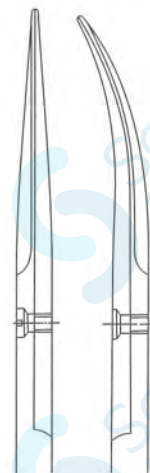

Gorney
S-70-0785 Straight
S-70-0787 Curved
7", 18 cm



Mayo
S-70-0790 5½", 14 cm
S-70-0791 6", 15 cm
S-70-0792 7", 18 cm
S-70-0793 8", 20 cm
Straight



Mayo
S-70-0795 5½", 14 cm
S-70-0796 6", 15 cm
S-70-0797 7", 18 cm
S-70-0798 8", 20 cm
Curved

Tungsten Carbide Wire Cutters



Universal

S-70-0810
4½", 11.5 cm
Ligature / Wire Cutting
Curved

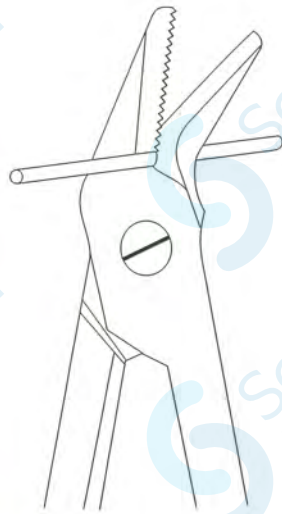

Wire Cutter

S-70-0812
5½", 14 cm
Simple Action

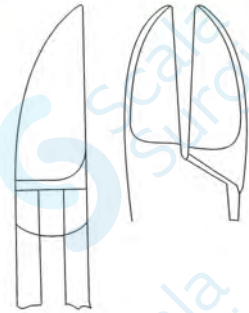

S-70-0814
5½", 13 cm
Angle



Wire Cutter

S-70-0816
5½", 14 cm



**Tungsten Carbide
Wire Cutting Pliers**

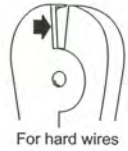

Wire Cutting Plier
S-70-0818
7", 18 cm
Front & Lateral Cutting Action

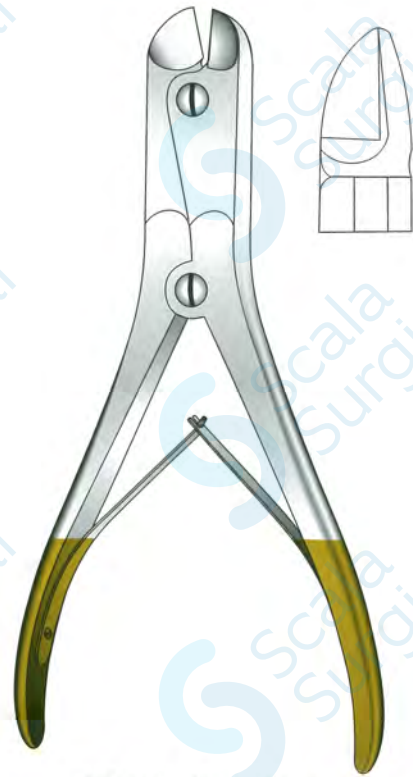

Wire Cutting Plier
S-70-0820
9 1/4", 23.5 cm
Lateral Cutting Action



Wire Cutter
S-70-0822 7", 18 cm
S-70-0824 8", 20 cm
S-70-0826 9", 23 cm
Hardened Cutting Edge

Wire Cutter



Wire Cutting Plier
S-70-0828
5 $\frac{1}{4}$ ", 14.5 cm
Front Cutting Action



Top / Wire Cutter
S-70-0830
8 $\frac{3}{4}$ ", 22 cm
Compound Action



Kirschner Wire Cutter
S-70-0832
18 $\frac{1}{2}$ ", 47 cm
Screw Bolts, Pins up to 6 mm dia

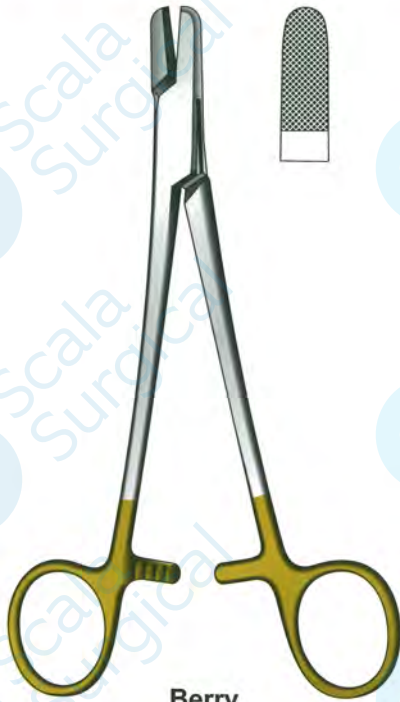

Berry
S-70-0850
7¼", 18.5 cm
Wire Twister, Ligature Forceps

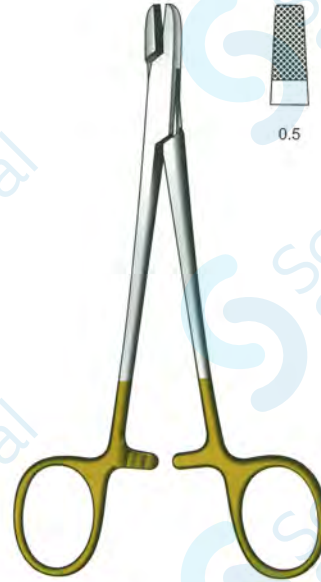

S-70-0852
6", 15 cm
Wire Twister, Ligature Forceps

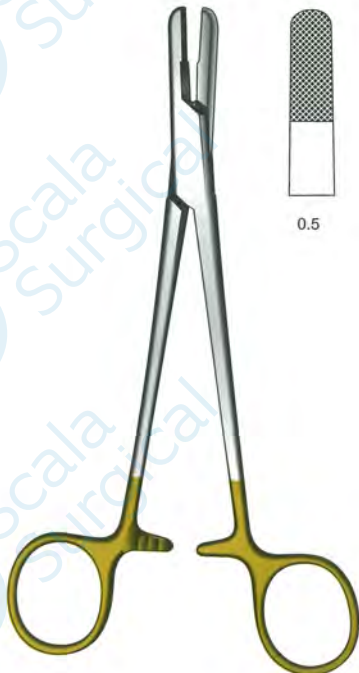

S-70-0854
7", 17.5 cm
Wire Twister, Ligature Forceps



Baumgartner
S-70-0856
8", 20 cm
Wire Twister, Ligature Forceps

Pliers

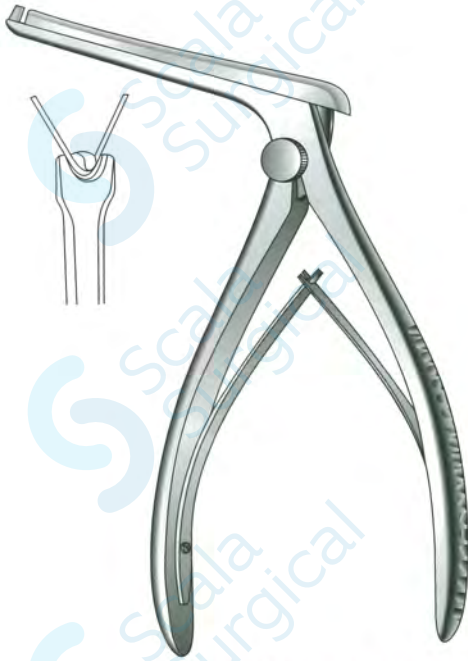

Wire Bending Plier
S-70-0860



Flat Nose Plier
S-70-0862
7¼", 18.5 cm



Serrated Jaws
S-70-0864
5½", 14 cm

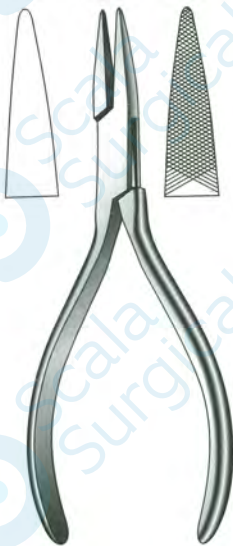

S-70-0866
5½", 14 cm
One Jaw Smooth
One Jaw Serrated



S-70-0868 Serrated Jaws
S-70-0870 Longitudinal & Transversal Groove
6¾", 17 cm



S-70-0872
7½", 19 cm
Fine Jaws

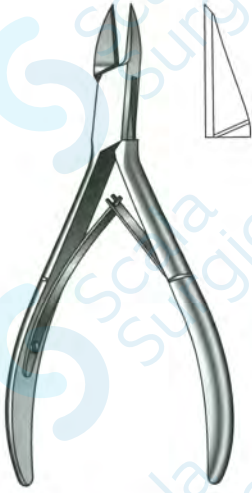

Ingrown Nail Nipper
S-08-0524
5", 13 cm
Box Joint, Sharp Points
Straight



Nail Cutter
S-08-0526
5½", 14 cm
Single Spring



Nail Cutter
S-08-0527 5½", 14 cm
Straight
S-08-0528 5½", 14 cm
S-08-0529 6", 15 cm
Concave
Box joint with Look



Nail Cutter
S-08-0532
5½", 14 cm
Concave
Box Joint / Barrel Spring

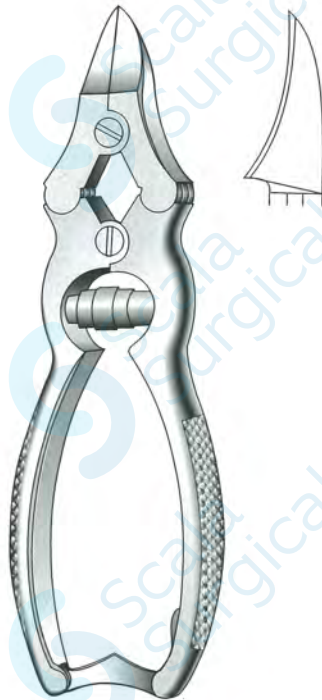

Nail Cutter
S-08-0533
6", 15 cm
Concave
Compound Action

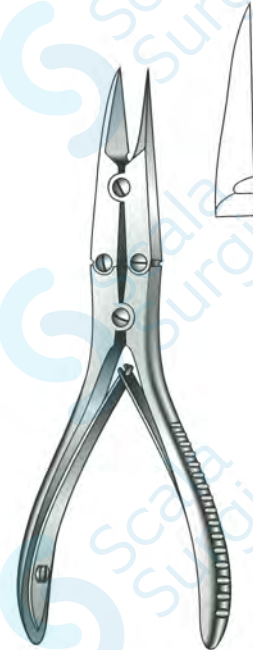

Nail Cutter
S-08-0534
6", 15 cm
Straight
Compound Action

Nail Cutters & Nippers



Thwaite
S-08-0535
5½", 14 cm
Nail Splitting

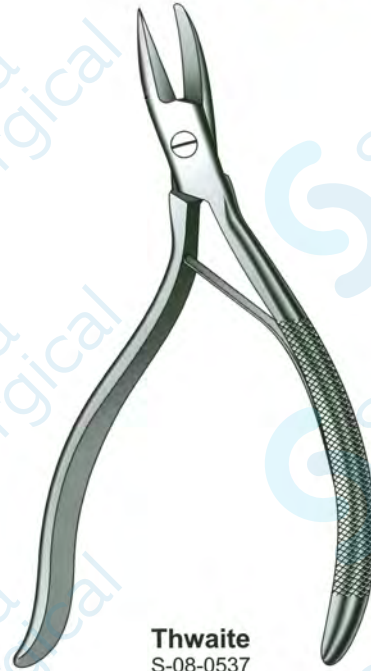

Thwaite
S-08-0537
5½", 14 cm
Pistol Grip



Moon Nipper
S-08-0538
5½", 14 cm

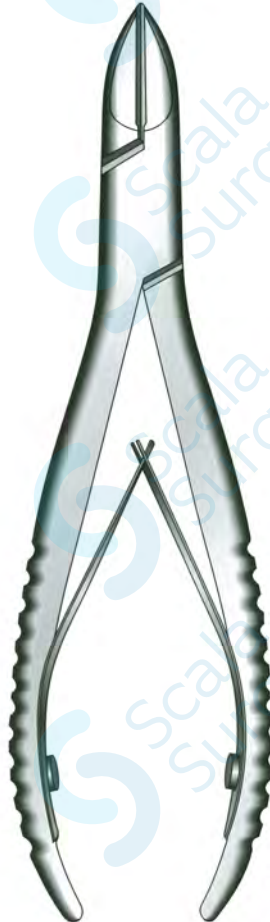

Dovo
S-08-0539
5½", 14 cm
Nail Cutter



Dovo
S-08-0540
5½", 14 cm
Nail Cutter



Cuticle Nipper
S-08-0544
4½", 11.5 cm
Double Spring

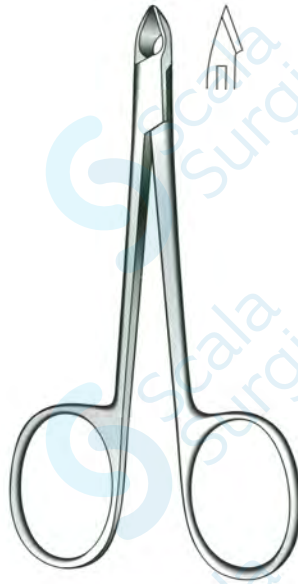

Cuticle Nipper
S-08-0546
4", 10 cm

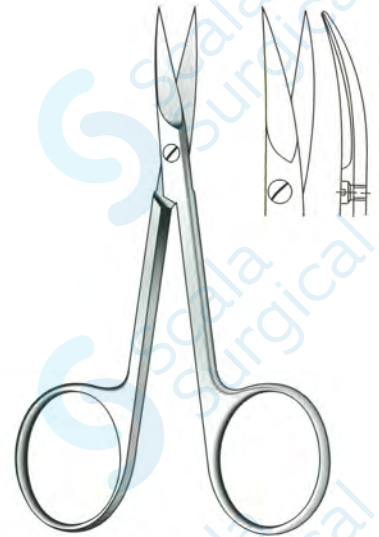

Cuticle Scissor
S-08-0549 Straight
S-08-0550 Curved
3½", 9 cm

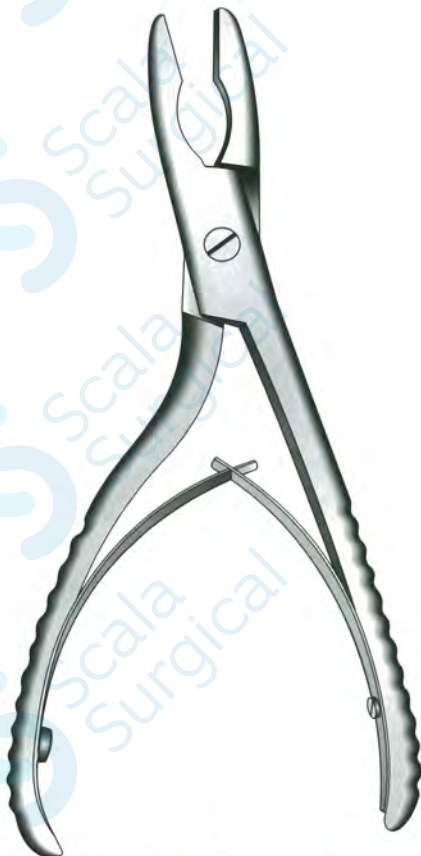

Daniel Rongeur
S-08-0552
5", 13 cm



Foot Retractors
S-08-0554
5", 13 cm
With Ratchet

Chiropody Instruments



Diamond Deb
S-08-0566
8", 20 cm
Foot Dresser



McKays Spatula
S-08-0567
6½", 16.5 cm
Foot Dresser



MacDonald Dissector
S-08-0569
7½", 19 cm

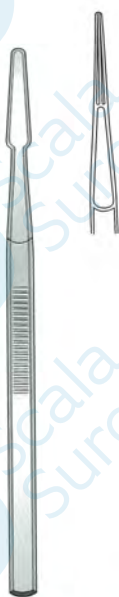

Locke Elevator
S-08-0570
4½", 11.5 cm
Spatula, Single Ended

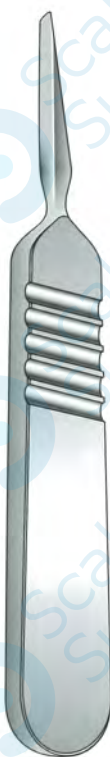

Francis
S-08-0571
4½", 11.5 cm
Chisel



Ficking
S-08-0572
4½", 11.5 cm
Elevator

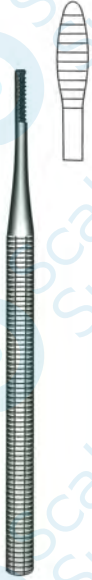

Black File
S-08-0573
Single Ended



Black File
S-08-0574 Fine Cut
S-08-0575 Coarse Cut
Double Ended



Fine Cut



Coarse Cut



Swan Neck Probe
S-08-0576
5½", 14 cm
Single Ended



Spatula / Packer
S-08-0578
5½", 14 cm
Double Ended



Tubegauze Applicator
S-08-0580
Size: 00
Small



Tubegauze Applicator
S-08-0581
Size: 0
large

Artery Forceps

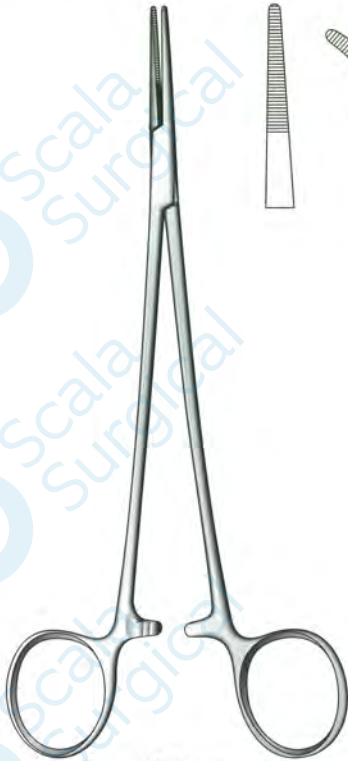

Adson
S-09-0555 Straight
S-09-0556 Curved
7", 18 cm
Box Joint

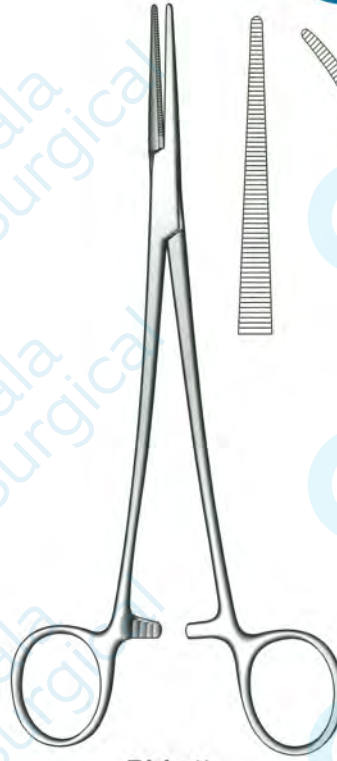

Birkett
S-09-0557 Straight
S-09-0558 Curved
S-09-0559 Angled to Side
7", 18 cm
Box Joint



Bengolea
S-09-0562 Serrated Jaws
S-09-0564 1:2 Teeth
Straight
8", 20 cm
Box Joint
S-09-0563
S-09-0565 Curved



Serrated Jaws
Straight



Serrated Jaws
Curved



1:2 Teeth
Straight



1:2 Teeth
Curved

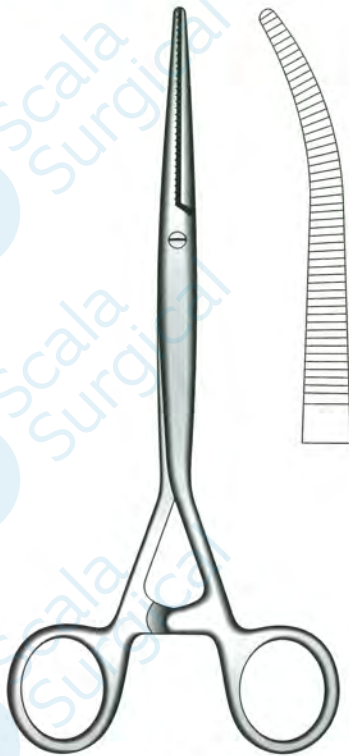

Bland Sutton
S-09-0566
7", 18 cm
Screw Joint, Curved



Belcher
S-09-0568 12", 30.5 cm
S-09-0569 15", 38 cm
Screw Joint, Curved

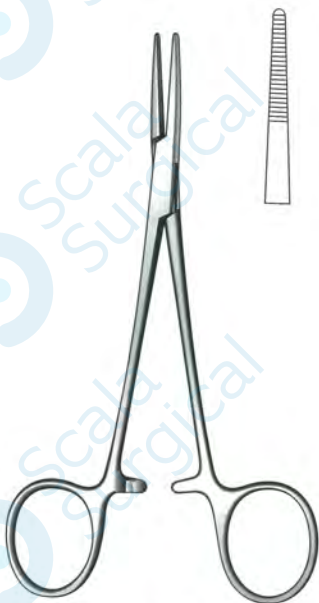

Cairns
S-09-0570 Straight
S-09-0571 Curved
S-09-0572 Curved to side
5 3/4", 14.5 cm
Box Joint

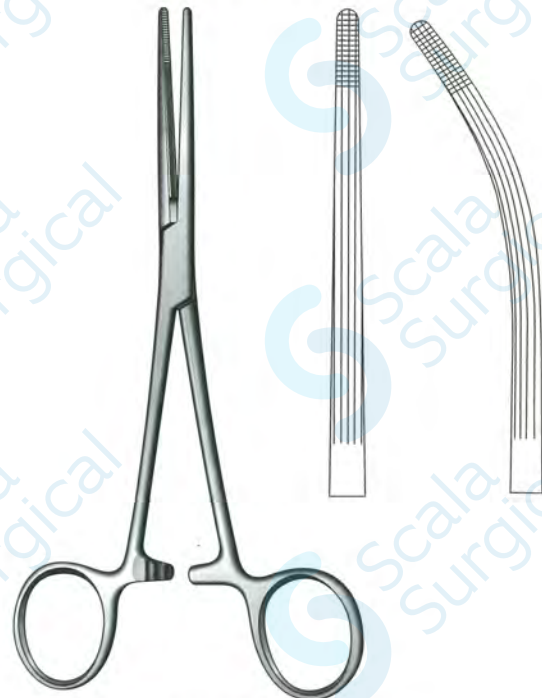

Carmalt
S-09-0573 6 1/4", 16 cm S-09-0575
S-09-0574 8", 20 cm S-09-0576
Straight Curved
Box Joint

Artery Forceps

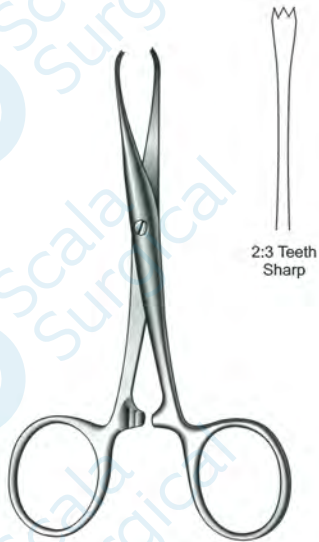

2:3 Teeth
Sharp

Chaput

- S-09-0577 5", 13 cm
- S-09-0578 5½", 14 cm
- S-09-0579 6", 15 cm
- 2:3 Teeth
- Screw Joint

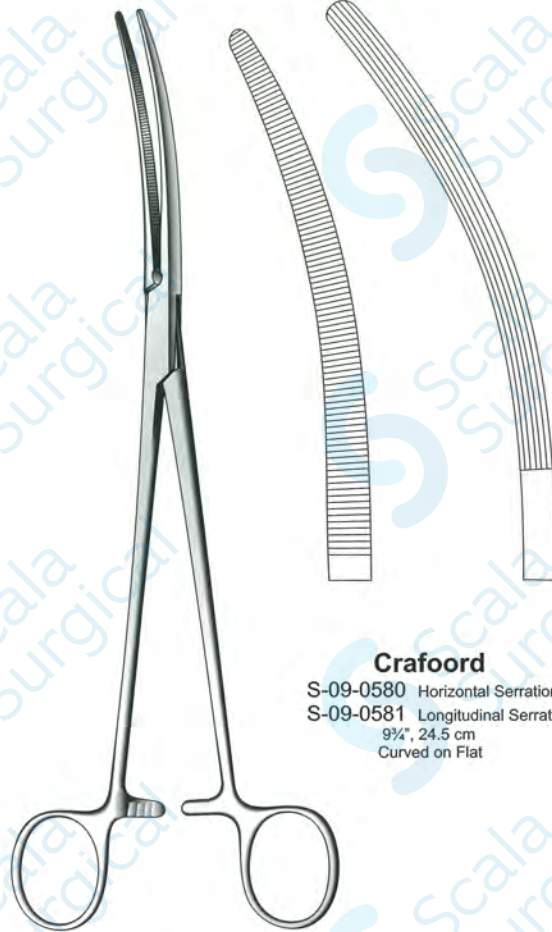

Craford

- S-09-0580 Horizontal Serration
- S-09-0581 Longitudinal Serration
- 9¾", 24.5 cm
- Curved on Flat



Collin

- S-09-0582
- 5½", 14 cm
- Screw Joint

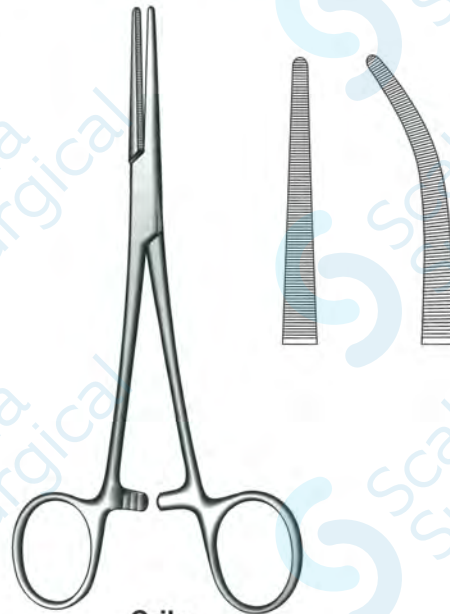

Crile

- S-09-0583 5½", 14 cm
- S-09-0584 6¼", 16 cm
- 7", 18 cm
- S-09-0585
- S-09-0586
- S-09-0587
- Straight
- Box Joint
- Curved

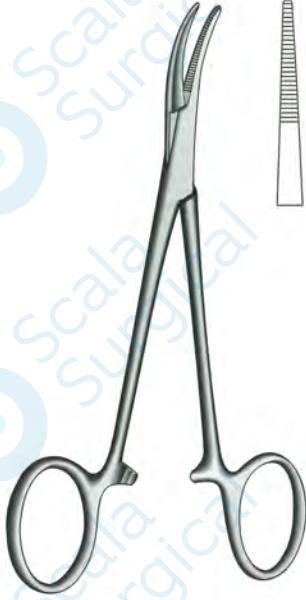

Cushing

S-09-0591 Straight
S-09-0592 Curved
S-09-0593 Curved to side
5½", 14.5 cm
Box Joint

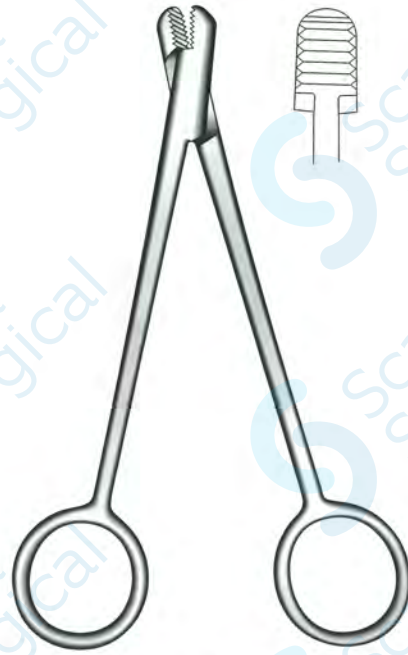

Denis Browne

S-09-0594
5½", 14 cm
Collar / Bead Crushing

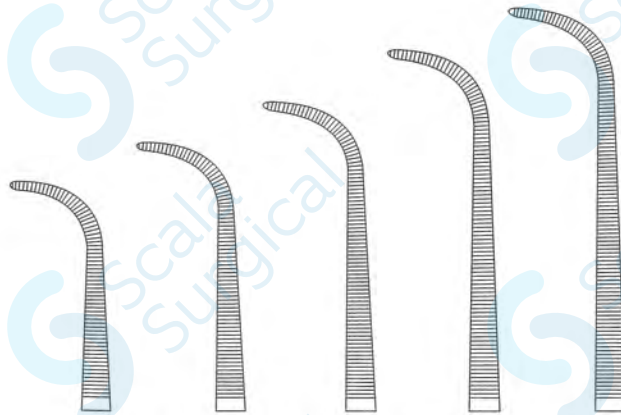

S-09-0595 5½", 14 cm S-09-0596 7", 18 cm S-09-0597 8", 20 cm S-09-0598 9", 23 cm S-09-0599 11", 28 cm

Gemini
Box Joint, Curved

Artery Forceps



Dieffenbach

- S-09-0600 2", 5 cm
- S-09-0601 2 3/4", 7 cm
- Straight, Bulldog Clamp



Dieffenbach

- S-09-0602 2", 5 cm
- S-09-0603 2 3/4", 7 cm
- Bulldog Clamp, Curved



John Hopkin

- S-09-0604 Straight, 2", 5 cm
- S-09-0605 Straight, 2 3/4", 7 cm
- S-09-0606 Curved, 2 3/4", 7 cm
- Bulldog Clamp

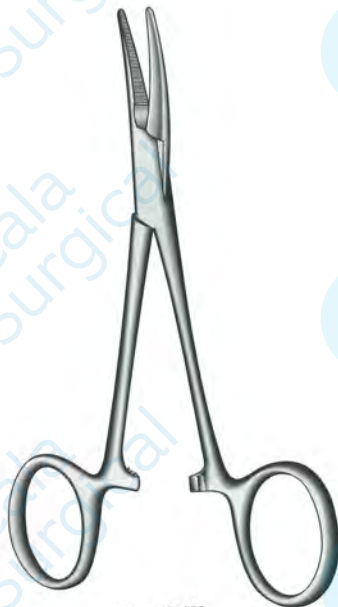

Dunhill

- S-09-0607 Box Joint, Straight, 7", 18 cm
- S-09-0608 Box Joint, Curved, 7", 18 cm
- S-09-0609 Box Joint, Straight, 5", 13 cm
- S-09-0610 Box Joint, Curved, 5", 13 cm
- S-09-0611 Screw Joint, Curved, 5", 13 cm

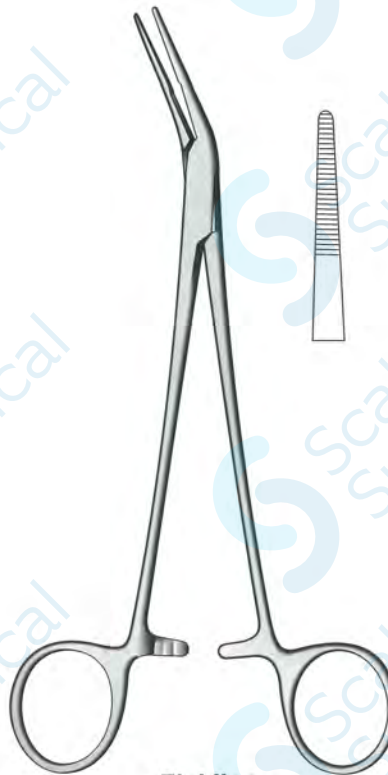

Fickling

- S-09-0612 Serrated
- S-09-0613 1:2 Teeth
- 7", 18 cm
- Box Joint



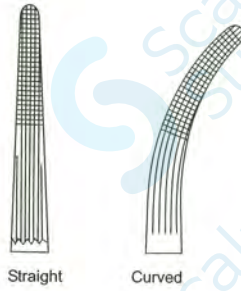

Grey Turner
 S-09-0618 5¼", 14.5 cm S-09-0620
 S-09-0619 7", 18 cm S-09-0621
 Straight Box Joint Curved

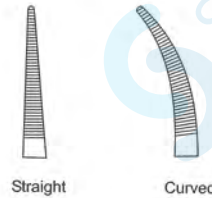
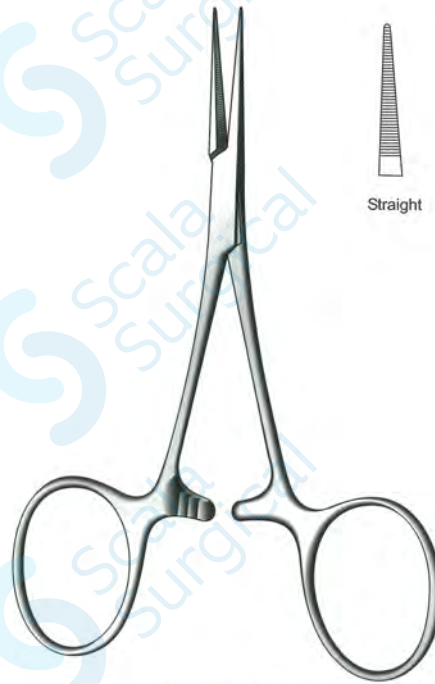

Hartmann
 S-09-0622 3½", 9 cm S-09-0624
 S-09-0623 4", 10 cm S-09-0625
 Straight Box Joint Curved

Artery Forceps

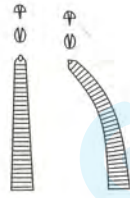
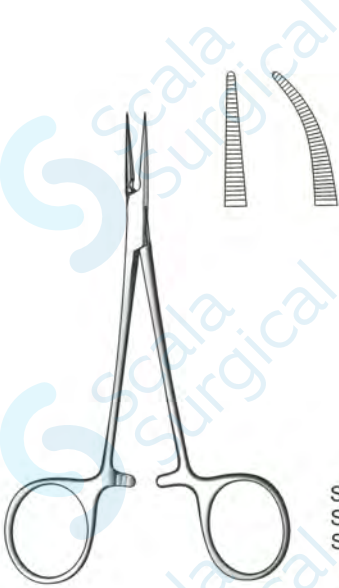

Halsted Mosquito

- | | | | |
|-----------|-----------|-----------|-----------|
| S-09-0626 | 5", 13 cm | S-09-0629 | |
| S-09-0627 | 7", 18 cm | S-09-0630 | |
| S-09-0628 | 8", 20 cm | S-09-0631 | |
| | Straight | | Curved |
| S-09-0632 | 5", 13 cm | S-09-0633 | |
| | Straight | | Curved |
| | | | 1:2 Teeth |

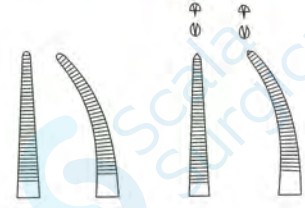

Micro Mosquito

- | | | | |
|-----------|-----------|-----------|-----------|
| S-09-0634 | Serrated | S-09-0635 | |
| S-09-0636 | 1:2 Teeth | S-09-0637 | |
| | Straight | | Curved |
| | | | 5", 13 cm |
| | | | Box Joint |

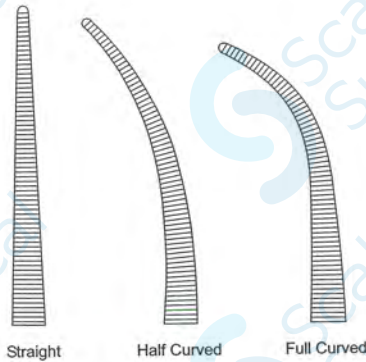
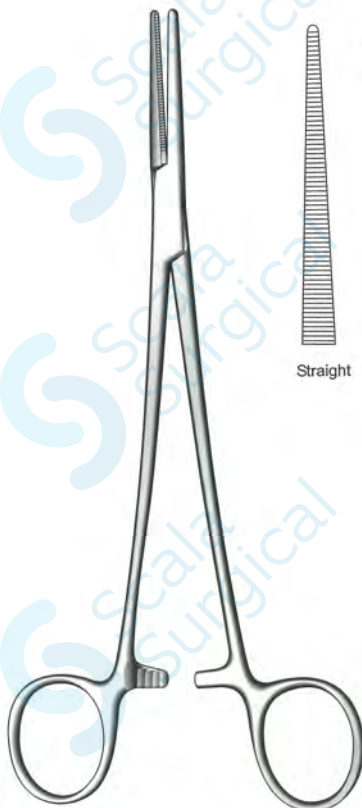

Heiss

- | | |
|-----------|----------------------|
| S-09-0638 | Straight |
| S-09-0639 | Half Curved |
| S-09-0640 | Full Curved |
| | 8", 20 cm, Box Joint |



Hamilton Bailey

- | | |
|-----------|---------------------|
| S-09-0641 | 7", 18 cm |
| S-09-0642 | 8", 20 cm |
| S-09-0643 | 9", 23 cm |
| | Screw Joint, Curved |

Artery Forceps

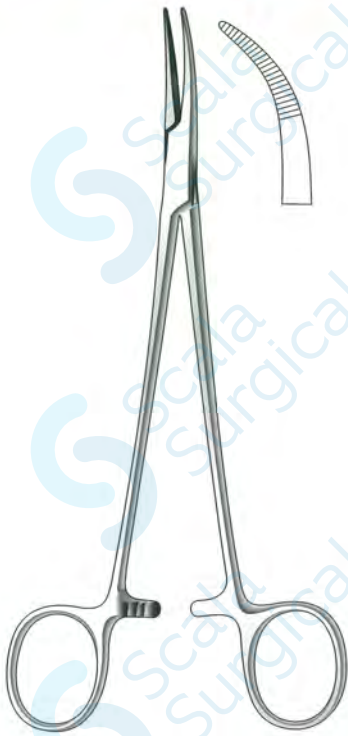

Johnson (Schmidt)
S-09-0644
10½", 26.5 cm
Curved, Box Joint

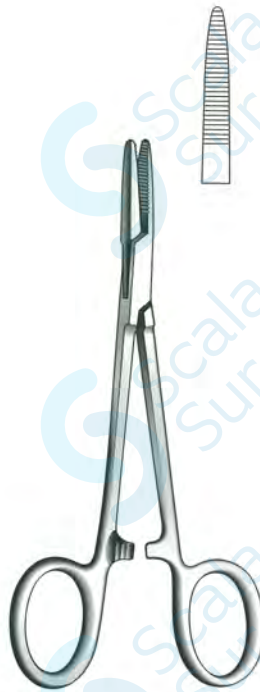

Joll
S-09-0645 Straight
S-09-0646 Curved
5¾", 14.5 cm
Box Joint

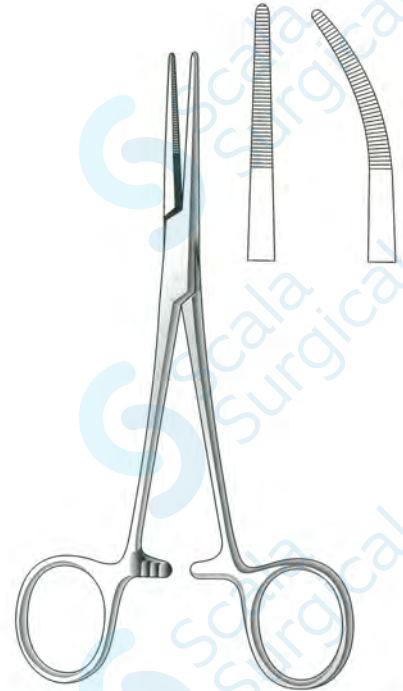

Kelly
S-09-0650 5½", 14 cm
S-09-0652
S-09-0651 6¼", 16 cm
S-09-0653
Straight Curved
Box Joint

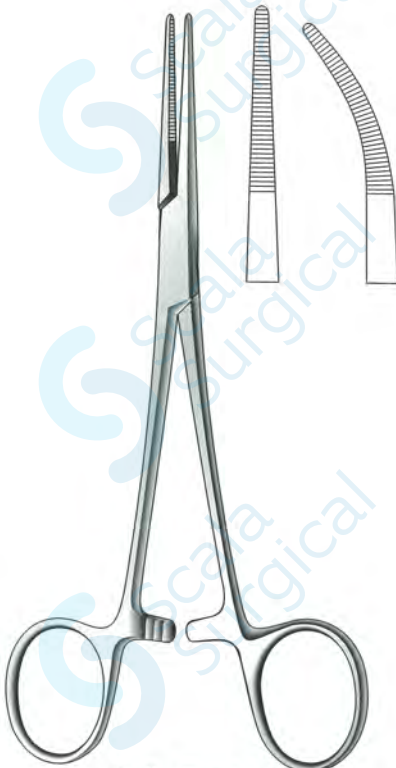

Kelly Rankin
S-09-0654 Straight
S-09-0655 Curved
6¼", 16 cm
Box Joint

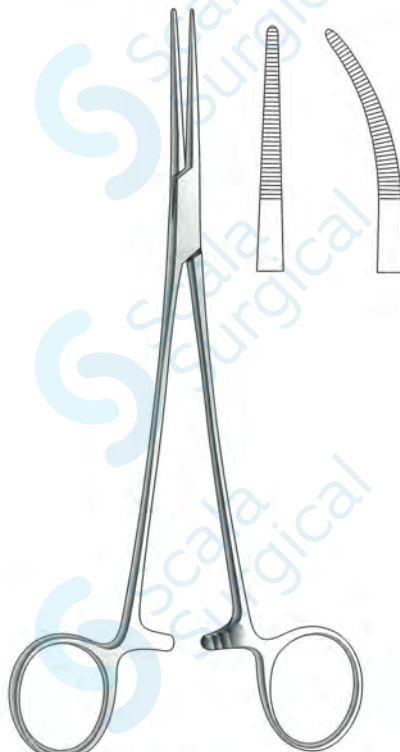

Kelly Fraser
S-09-0656 Straight
S-09-0657 Curved
7", 18 cm
Box Joint

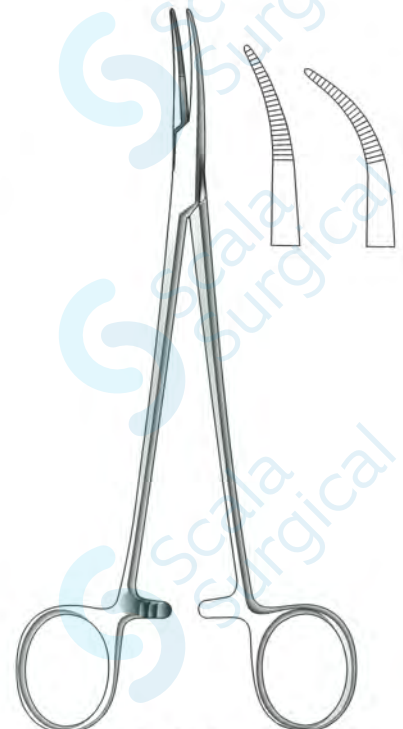

Kelly Halsted
S-09-0658 Straight
S-09-0659 Curved
6¼", 17 cm
Box Joint

Artery Forceps

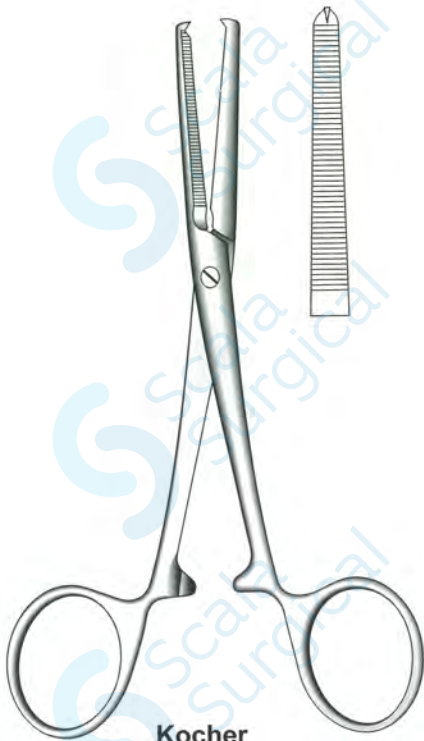

Kocher

Screw Joint

S-09-0665	5", 13 cm	S-09-0675
S-09-0666	5½", 14 cm	S-09-0676
S-09-0667	6", 15 cm	S-09-0677
S-09-0668	7", 18 cm	S-09-0678
S-09-0669	8", 20 cm	S-09-0679
S-09-0670	9", 23 cm	S-09-0680
	Straight	Curved

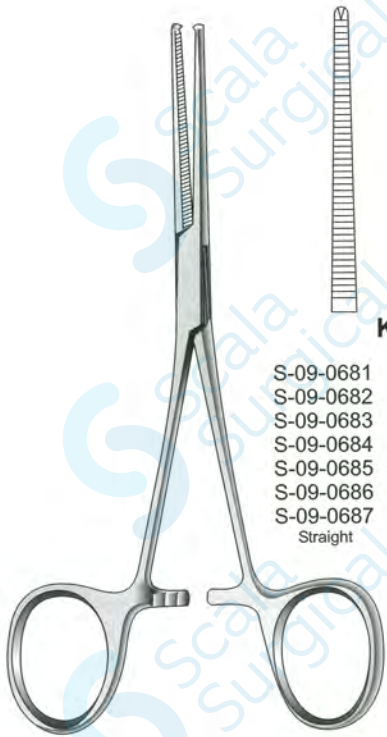

Kocher

Box Joint

S-09-0681	5", 13 cm	S-09-0688
S-09-0682	5½", 14 cm	S-09-0689
S-09-0683	6", 15 cm	S-09-0690
S-09-0684	7", 18 cm	S-09-0691
S-09-0685	8", 20 cm	S-09-0692
S-09-0686	9", 23 cm	S-09-0693
S-09-0687	11", 28 cm	S-09-0694
	Straight	Curved

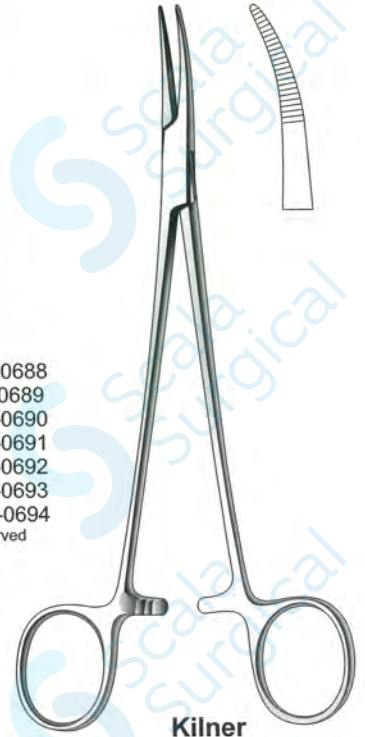

Kilner

S-09-0695	Straight
S-09-0696	Curved
	5¾", 14 cm
	Box Joint

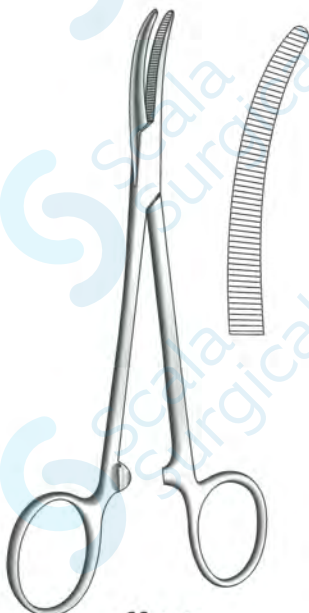

Mayo

S-09-0697
6¾", 16 cm
Box Joint, Curved



Ochsner

S-09-0700	6½", 16.5 cm	S-09-0706
S-09-0701	7¼", 18.5 cm	S-09-0707
S-09-0702	8", 20 cm	S-09-0708
S-09-0703	9", 23 cm	S-09-0710
	Straight	Curved

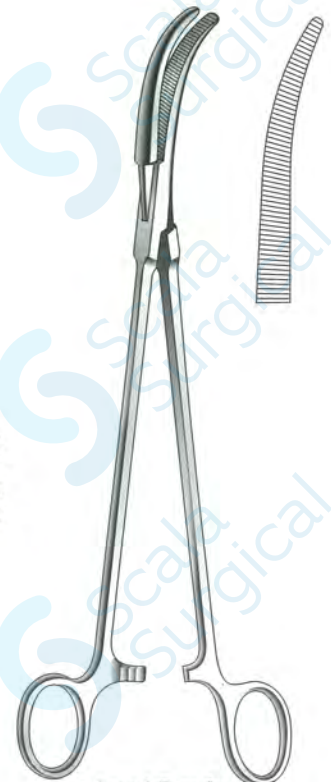

Lloyd Davis

S-09-0715	Light Pattern
S-09-0716	Heavy Pattern
	10¼", 26 cm

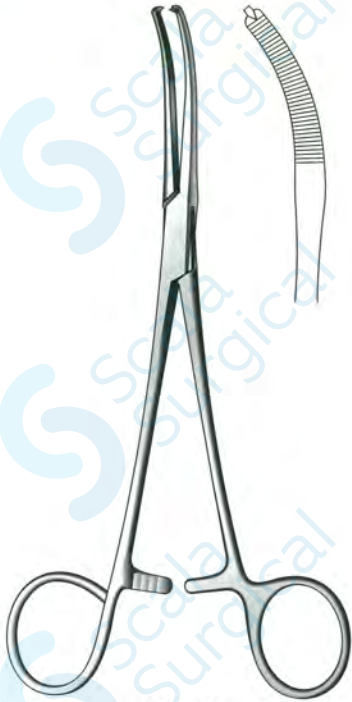

Mikulicz
S-09-0718
8", 20 cm
Curved

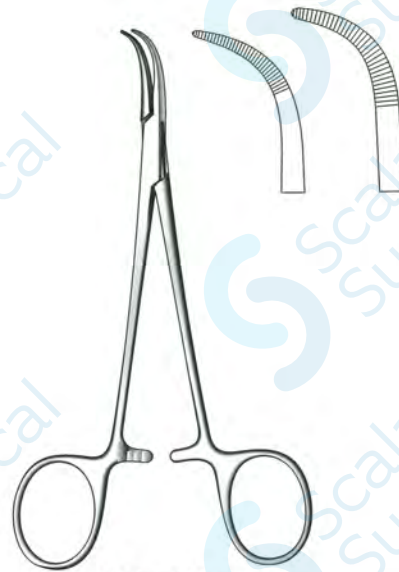

Baby-Mixer
S-09-0720 5½", 14cm
S-09-0721 7", 18 cm
Curved

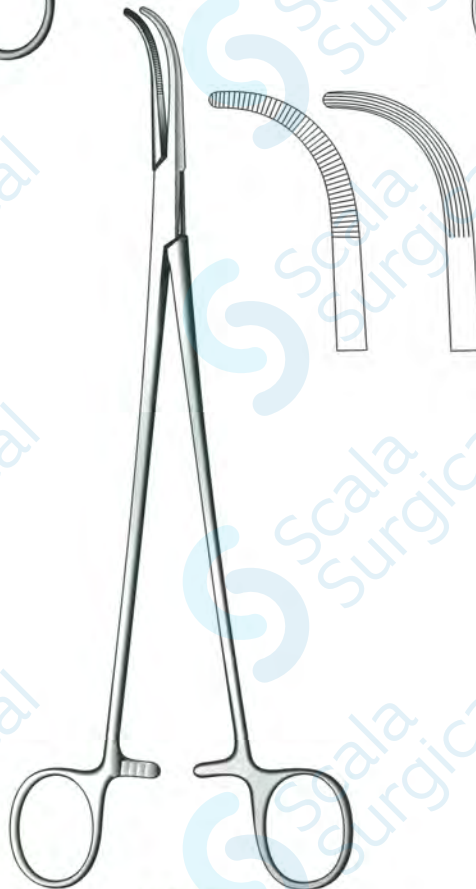

Mixer
S-09-0725 8½", 21.5 cm
S-09-0726 9", 23 cm
S-09-0727 11", 28 cm
Curved Horizontal Serration
S-09-0729 9", 23 cm
Curved Longitudinal Serration



Mixer-O Shaughnessy
S-09-0733 6", 15 cm
S-09-0734 7½", 19 cm
S-09-0735 12", 30.5 cm
Curved

Artery Forceps

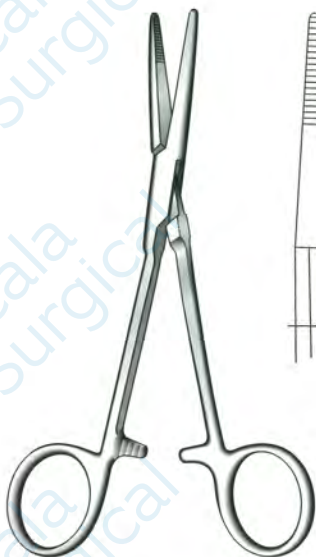

Moynihan

S-09-0739 5½", 14.5 cm
S-09-0740 7", 18 cm
Straight

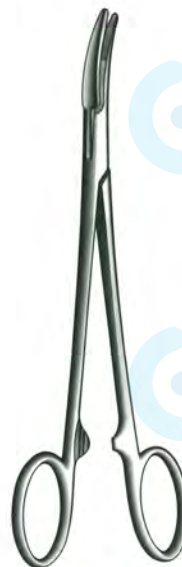

Moynihan

S-09-0739 5½", 14.5 cm
S-09-0740 7", 18 cm
Curved



Miles Phillip

S-09-0741
7", 18 cm
Curved on Flat



Micron

S-09-0743 3½", 9 cm S-09-0747
S-09-0745 5½", 14 cm S-09-0749
Straight Curved



S-09-0750
5½", 14 cm



S-09-0751
6¼", 16 cm



S-09-0752
7¼", 18.5 cm



S-09-0753
8", 20 cm



S-09-0754
9", 23 cm



S-09-0755
9½", 24 cm



S-09-0758
5½", 14 cm



S-09-0759
6¼", 16 cm



S-09-0760
7¼", 18.5 cm



S-09-0761
8", 20 cm



S-09-0762
9", 23 cm



S-09-0763
9½", 24 cm

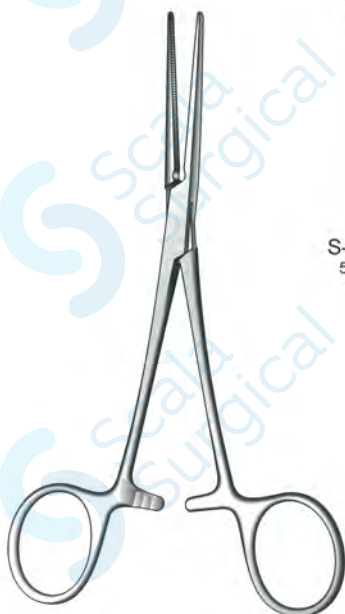

Rochester-Pean

Artery Forceps



Negus

S-09-0765 Short Curved
S-09-0767 Long Curved
7 1/2", 18.5 cm

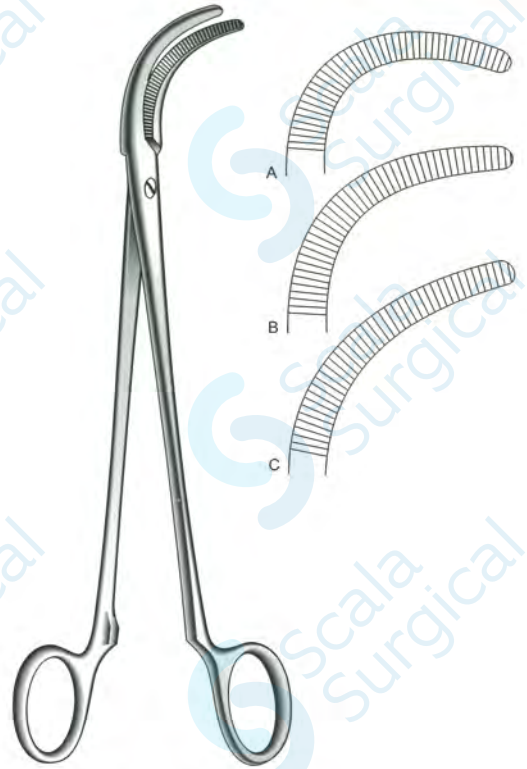

Ronald Edwards

S-09-0768 Shape A
S-09-0769 Shape B
S-09-0770 Shape C
8 1/2", 21.5 cm
Screw Joint

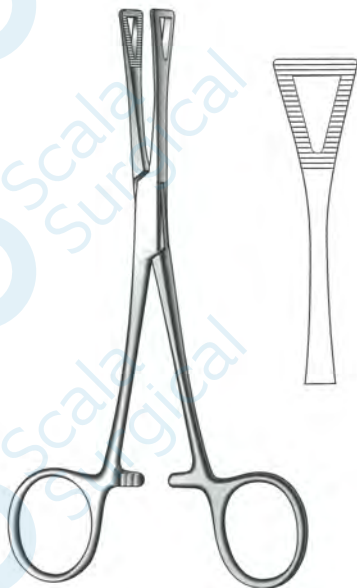

Pennington

S-09-0771 6", 15 cm
S-09-0773 8", 20 cm
Straight

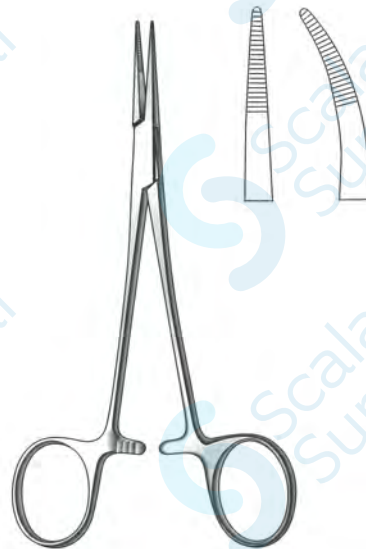

Providence-Hospital

S-09-0775 Straight
S-09-0777 Curved
5 1/2", 14 cm

Artery Forceps

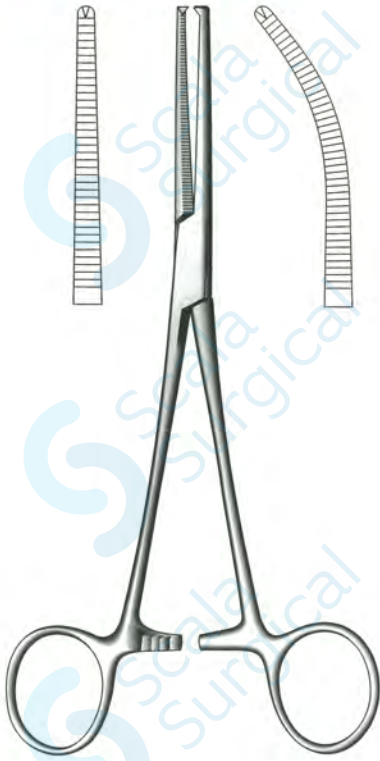

Rochester-Ochsner

S-09-0780 5½", 14 cm S-09-0785
S-09-0781 6¼", 16 cm S-09-0786
S-09-0782 7", 18 cm S-09-0787
Straight Curved



Roberts

S-09-0788 9", 23 cm
S-09-0789 12", 30.5 cm
S-09-0790 15", 38 cm
S-09-0791 18", 46 cm
Screw Joint

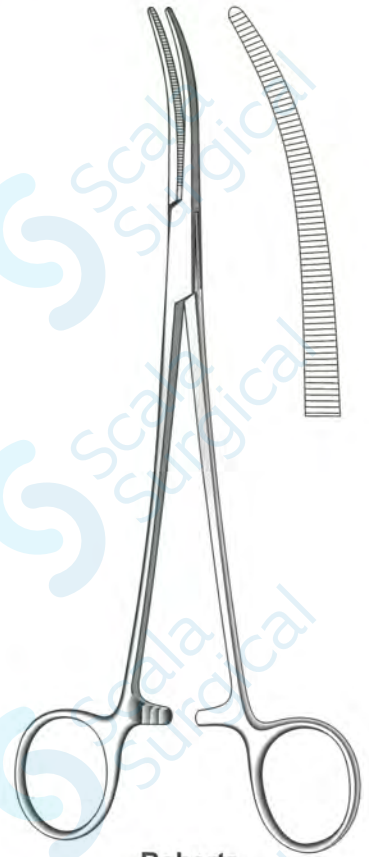

Roberts

S-09-0793 9", 23 cm
S-09-0794 12", 30.5 cm
S-09-0795 15", 38 cm
Box Joint

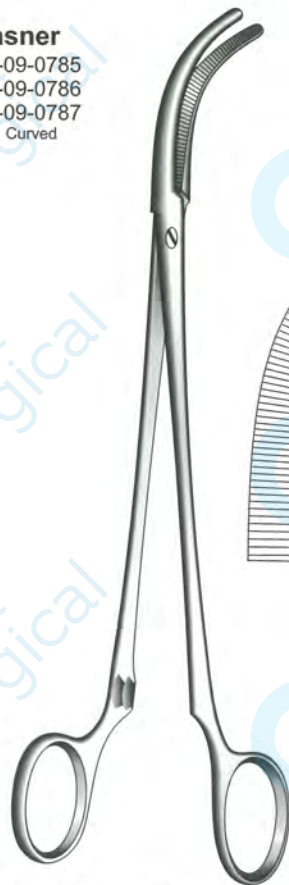

Tudor Edwards

S-09-0797
9", 23 cm
Screw Joint

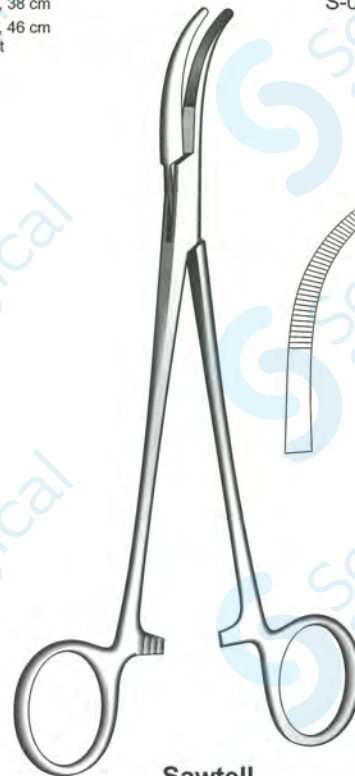

Sawtell

S-09-0799
7", 18 cm
Box Joint

Artery Forceps



Spencer Wells

Screw Joint

S-09-0816	5", 13 cm	S-09-0826
S-09-0817	6", 15 cm	S-09-0827
S-09-0818	7", 18 cm	S-09-0828
S-09-0819	8", 20 cm	S-09-0829
S-09-0820	9", 23 cm	S-09-0830
S-09-0821	12", 30.5 cm	S-09-0831
	Straight	Curved



Spencer Wells

Box Joint

S-09-0836	5", 13 cm	S-09-0846
S-09-0837	6", 15 cm	S-09-0847
S-09-0838	7", 18 cm	S-09-0848
S-09-0839	8", 20 cm	S-09-0849
S-09-0840	9", 23 cm	S-09-0850
S-09-0841	12", 30.5 cm	S-09-0851
	Straight	Curved

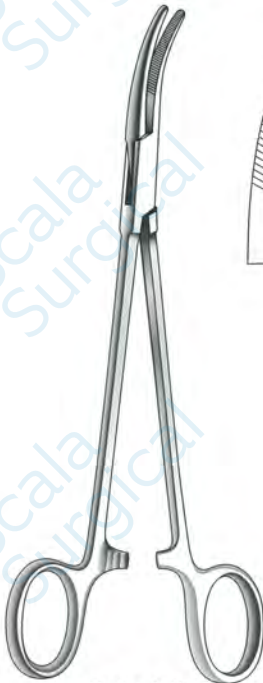

Schmidt

S-09-0860
7½", 19 cm
Curved
Box Joint



Sarot

S-09-0861 Straight
S-09-0862 Curved
9½", 24 cm



Scott
S-09-0864
7", 18 cm
Screw Joint

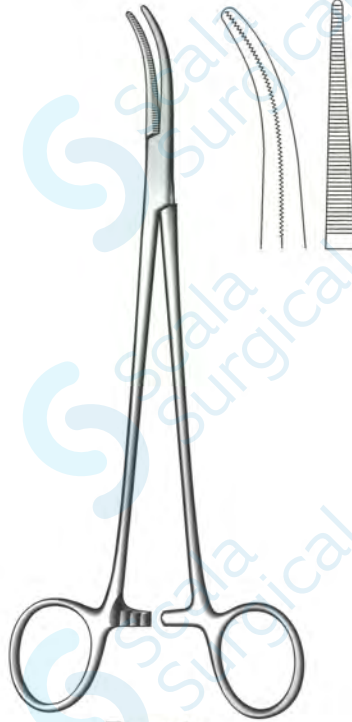

Toennis
S-09-0866 Straight
S-09-0867 Curved
8 1/4", 21 cm
Box Joint

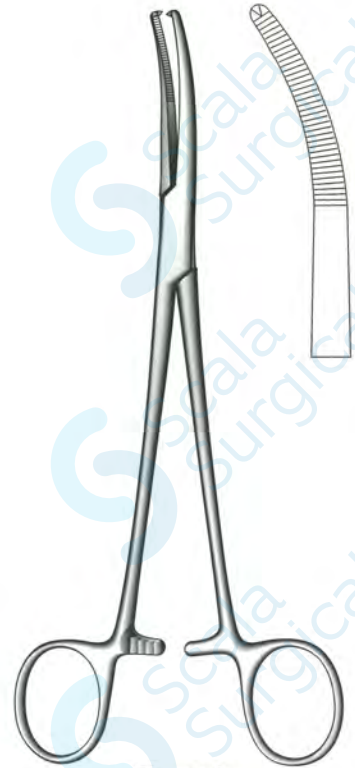

Toennis
S-09-0869 Straight
S-09-0870 Curved
8 1/4", 21 cm
1:2 Teeth, Box Joint

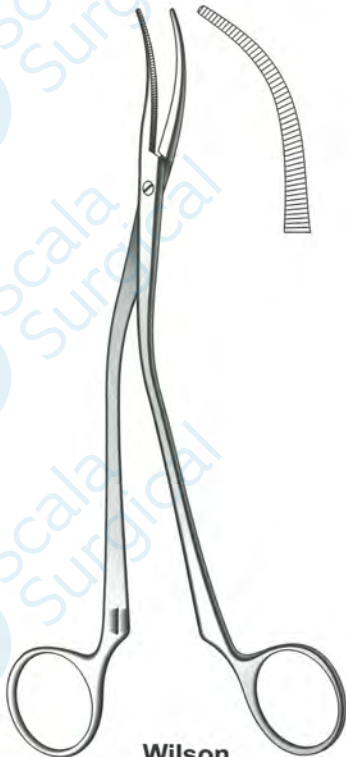

Wilson
S-09-0872
7", 18 cm



Wright
S-09-0874
5", 13 cm

Tube Milking Forceps & Clamps

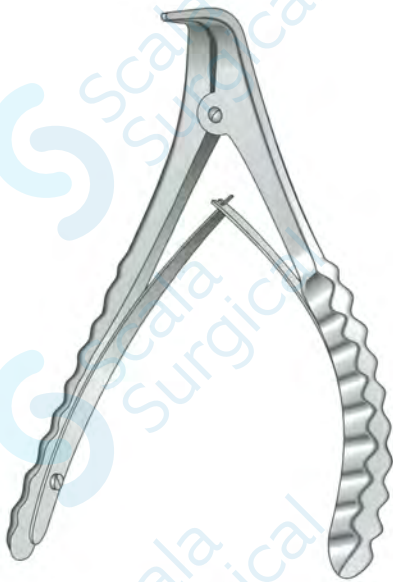

Ross Pattern
S-10-0890
5", 13 cm
Tubing Stretcher

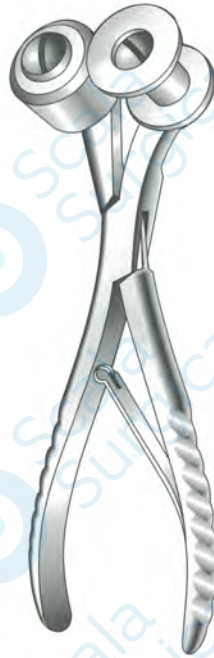

Foss Milking
S-10-0895
7", 18 cm



Brompton Hospital Pattern
S-10-0900
Milking Forceps

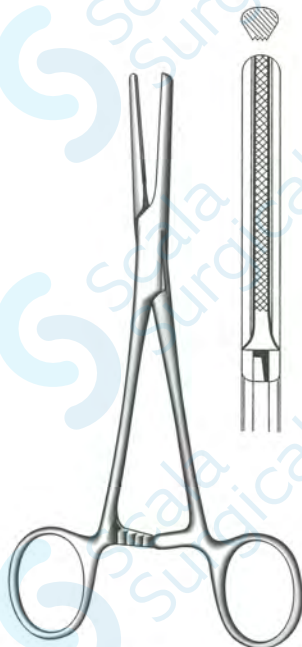

St. Bartholomews
S-10-0902 6", 15 cm
S-10-0903 7", 18 cm
Straight

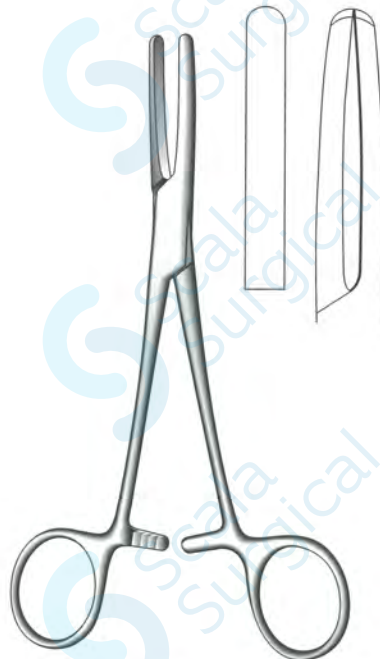

Presbyterian
S-10-0904 6½", 16.5 cm
S-10-0905 7¾", 19.5 cm
S-10-0906 8", 20 cm
Box Joint, Straight



Sully Hospital Pattern
S-10-0907 6", 15 cm
S-10-0908 7", 18 cm
S-10-0909 8", 20 cm
Screw Joint, Straight
Plain Jaws

Tubing Clamps

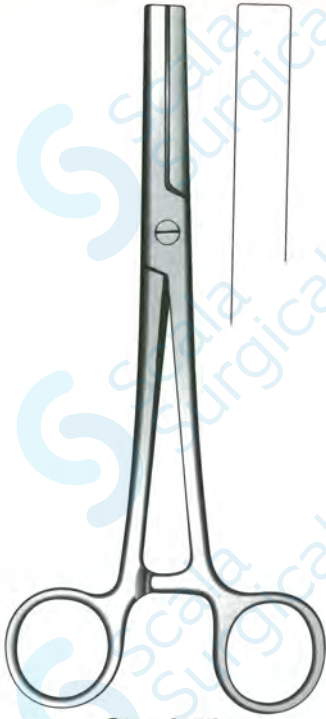

Standard

S-10-0910 5", 13 cm
 S-10-0911 7", 18 cm
 S-10-0912 8", 20 cm
 S-10-0913 9", 23 cm
 Straight, Box Joint
 Plain Jaws

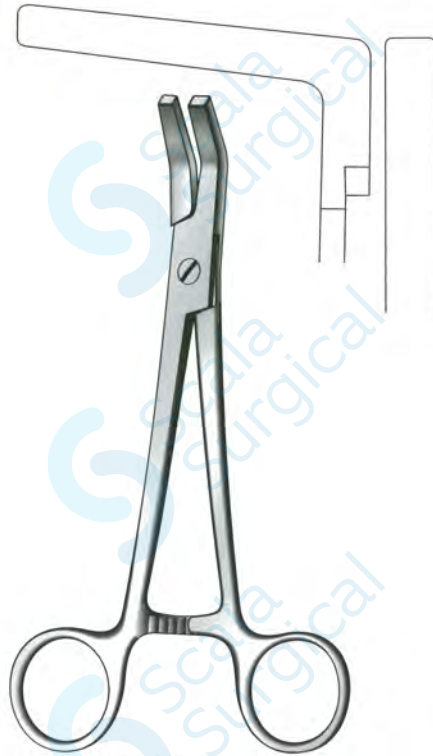

Standard

S-10-0915 4½", 11.5 cm
 S-10-0916 6", 15 cm
 S-10-0917 7", 18 cm
 Angled on Flat

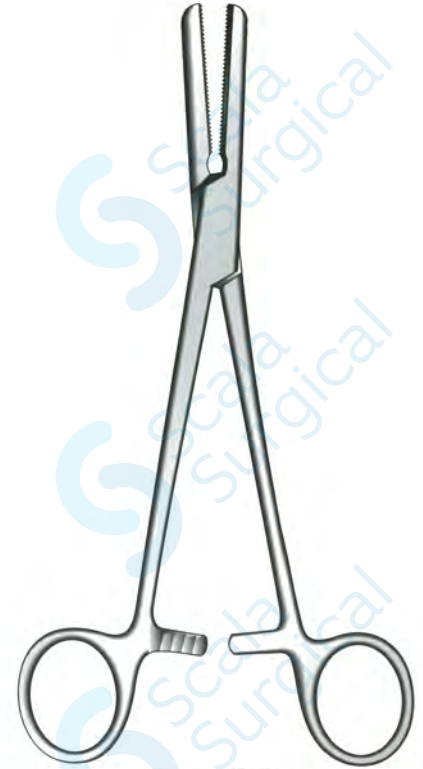

Heavy Pattern

S-10-0925
 8", 20 cm
 Bow Straight Serrated Jaws

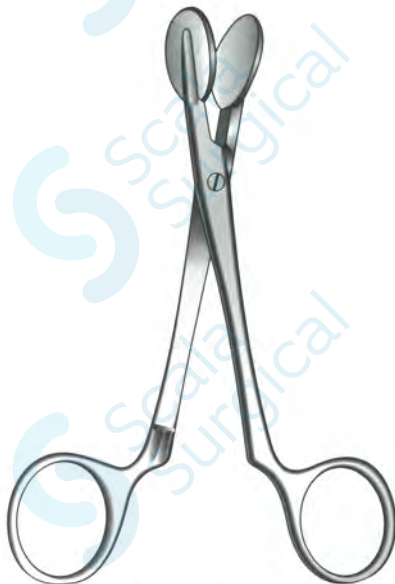

King Vein Graft Press

S-10-0930
 5", 13 cm
 Circular Jaws

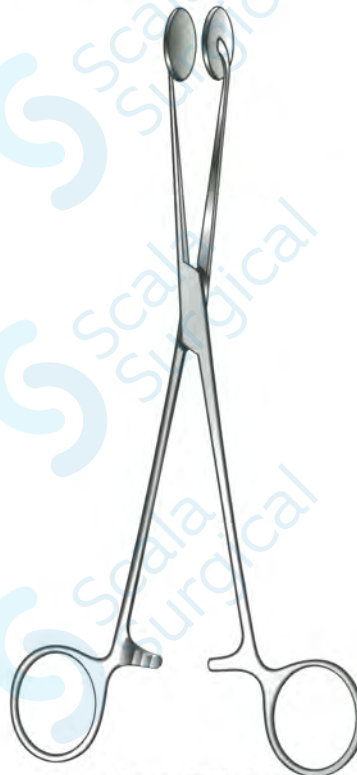

Ross Patch

S-10-0935
 8", 20 cm
 Holding Forceps

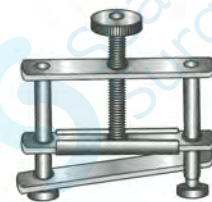

Hoffman

S-10-0938 internal Width 12 mm
 S-10-0939 internal Width 16 mm
 S-10-0940 internal Width 20 mm

Wire Twisting & Ductus Forceps

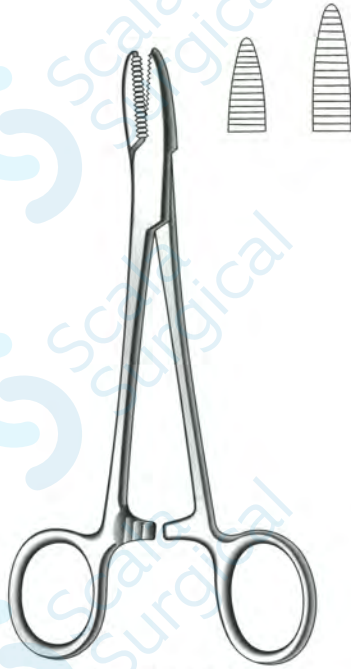

Lawson Tait
S-10-0946
5½", 14 cm



Heyton Williams
S-10-0948
5", 13 cm

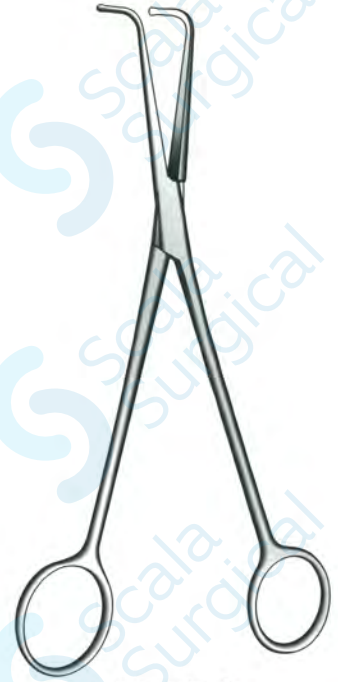

**Waterston's
Dissector**
S-10-0950
6", 15 cm
Angled



Waterston's Dissector
S-10-0951
6", 15 cm
Curved

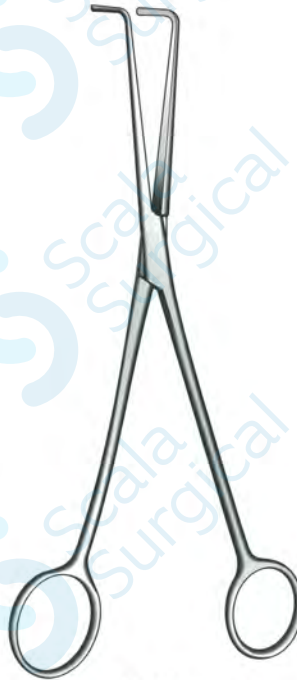

Dennis Browne
S-10-0954
8", 20 cm
Angled



Dennis Browne
S-10-0955
8", 20 cm
Curved

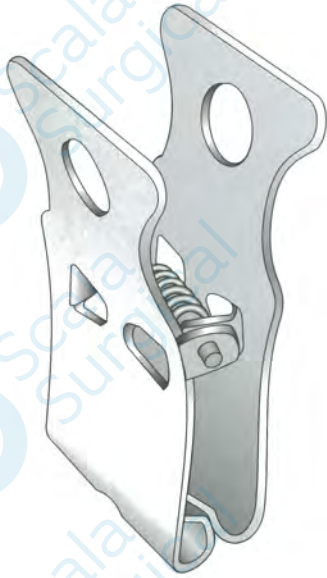

X-Ray / Bags Clips
S-10-0970
One inch Wide

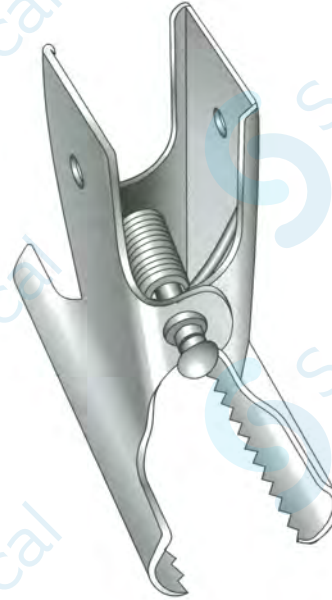

Zimmer Clips
S-10-0973
2½" Wide, Serrated Jaws

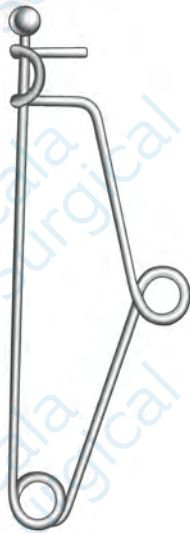

Mayo Safety Pins
S-10-0975 4½", 11.5 cm
S-10-0976 5", 13 cm
S-10-0977 5½", 14 cm
S-10-0978 6", 15 cm

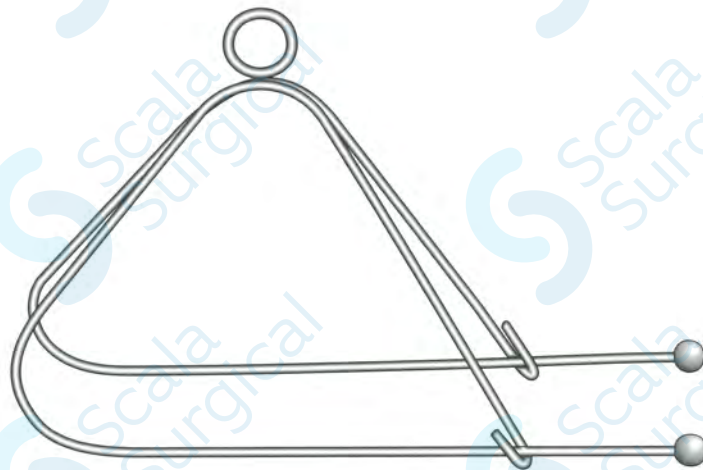

Mayo Safety Pins
S-10-0980
5", 13 cm
Double

Dissecting Forceps



Turn-Over-End

S-11-0950	5", 13 cm
S-11-0951	6", 15 cm
S-11-0952	7", 18 cm
S-11-0953	8", 20 cm
S-11-0954	9", 23 cm
S-11-0955	10", 25.5 cm
S-11-0956	12", 30.5 cm
Medium Points	
Serrated Jaws	



Block-End

S-11-0960	5", 13 cm
S-11-0961	6", 15 cm
S-11-0962	7", 18 cm
S-11-0963	8", 20 cm
S-11-0964	9", 23 cm
S-11-0965	10", 25.5 cm
S-11-0966	12", 30.5 cm
Medium Points	
Serrated Jaws	



Continental Pattern

S-11-0970	5", 13 cm
S-11-0971	5½", 15 cm
S-11-0972	6¼", 16 cm
S-11-0973	7", 18 cm
S-11-0974	8", 20 cm
S-11-0975	9", 23 cm
S-11-0976	10", 25.5 cm
S-11-0977	12", 30.5 cm
S-11-0978	16", 40.5 cm
S-11-0979	18", 46 cm
Medium Jaws	



Continental Pattern

S-11-0982	5", 13 cm
S-11-0983	5½", 14 cm
S-11-0984	6¼", 16 cm
S-11-0985	7", 18 cm
S-11-0986	8", 20 cm
S-11-0987	10", 25.5 cm
S-11-0988	12", 30.5 cm
1:2 Teeth	



Continental Pattern

S-11-0989	5", 13 cm
S-11-0990	5½", 14 cm
S-11-0991	6¼", 16 cm
S-11-0992	7", 18 cm
S-11-0993	8", 20 cm
2:3 Teeth	



Continental Pattern

S-11-0994	5", 13 cm
S-11-0995	5½", 14 cm
S-11-0996	6¼", 16 cm
S-11-0997	7", 18 cm
S-11-0998	8", 20 cm
3:4 Teeth	

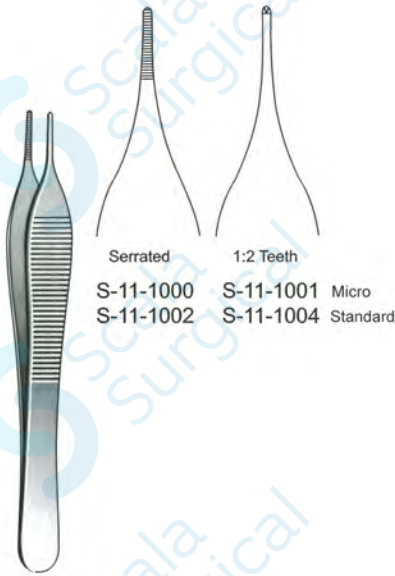

Serrated
S-11-1000
S-11-1002

1:2 Teeth
S-11-1001
S-11-1004

Micro
Standard

Adson
5", 12.5 cm

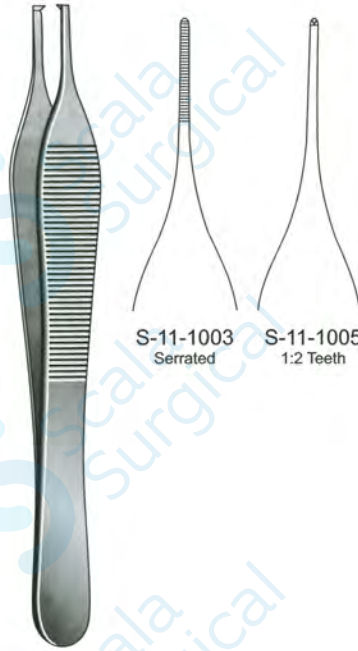

S-11-1003
Serrated

S-11-1005
1:2 Teeth

Adson
S-11-1003 Serrated
S-11-1005 1:2 Teeth
7", 18 cm

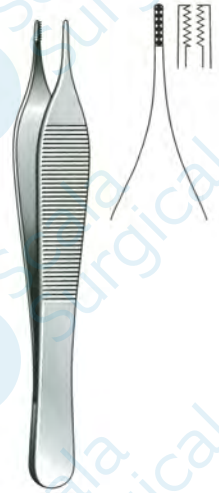

Adson Browne
S-11-1007
5", 13 cm
7:7 Teeth



Adson
S-11-1010 Serrated
S-11-1012 1:2 Teeth
7", 18 cm
Bayonet Shape

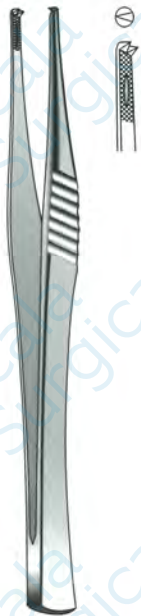

Fine-Pointed
With Guide Pin

S-11-1014 4½", 11.5 cm
S-11-1015 5", 13 cm
S-11-1016 6", 15 cm

S-11-1018
S-11-1019
S-11-1020

Straight Curved

Alder Creutz

S-11-1022 2:3 Teeth, 6", 15 cm
S-11-1023 2:3 Teeth, 8", 20 cm
S-11-1024 4:5 Teeth, 5", 13 cm
S-11-1025 4:5 Teeth, 6", 15 cm
S-11-1026 4:5 Teeth, 8", 20 cm
S-11-1027 5:6 Teeth, 10", 25.5 cm
S-11-1028 Serrated, 6", 15 cm
S-11-1029 Serrated, 8", 20 cm

Braithwaite
S-11-1032
6", 15 cm
1:2 Teeth

Dissecting Forceps



Bickford
S-11-1033 Serrated
S-11-1034 1:2 Teeth
9", 23 cm

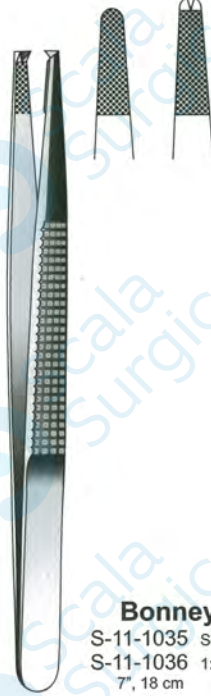

Bonney
S-11-1035 Serrated
S-11-1036 1:2 Teeth
7", 18 cm



Brophy
S-11-1038 Serrated
S-11-1039 1:2 Teeth
8", 20cm



Cairns
S-11-1045 6½", 16.5 cm
S-11-1046 8½", 21.5 cm
2:3 Teeth



Canadian Pattern
S-11-1047 Serrated, 5½", 14 cm
S-11-1048 1:2 Teeth, 5½", 14 cm
S-11-1049 2:3 Teeth, 5½", 14 cm
S-11-1050 2:3 Teeth, 6", 15 cm



Charnley
S-11-1051 5½", 14.5 cm
S-11-1052 7", 18 cm

Dissecting Forceps

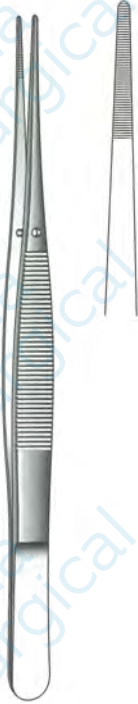

Cushing

S-11-1053 7", 18 cm S-11-1055
S-11-1054 8", 20 cm S-11-1056
Straight Curved



College Pattern

S-11-1057 Curved
S-11-1058 Angled
6 1/2", 16 cm



Desgouttes

S-11-1059 6 1/2", 17 cm
S-11-1060 8", 20 cm
S-11-1061 10", 25.5 cm
S-11-1062 12", 30.5 cm
Straight
4:5 Teeth



De-Bakey

S-11-1063 6", 15 cm
S-11-1064 7", 18 cm
S-11-1065 8", 20 cm
S-11-1066 9", 23 cm
S-11-1067 10", 25.5 cm
S-11-1068 11", 28 cm
S-11-1069 12", 30.5 cm
S-11-1070 14", 35.5 cm

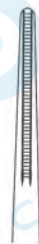
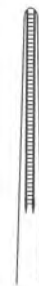

Dissecting Forceps



Dott
S-11-1072
7", 18 cm
Straight Serrated



Duval
S-11-1073
6", 15 cm
½", Jaws

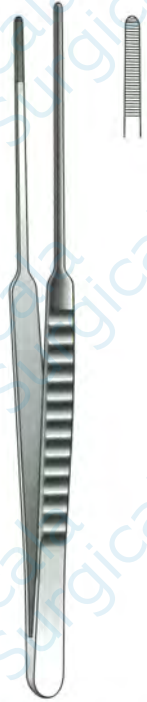

Emmet
S-11-1074 5", 13 cm
S-11-1075 6", 15 cm
S-11-1076 8", 20 cm
S-11-1077 10", 25.5 cm



Gillies
S-11-1079 1:2 Teeth
S-11-1080 Serrated
6", 15 cm



Iris
S-11-1083 3", 7.5 cm
S-11-1084 4", 10 cm
S-11-1085 4½", 11.5 cm
Straight, Serrated
S-11-1086 3", 7.5 cm
S-11-1087 4", 10 cm
S-11-1088 4½", 11.5 cm
Straight 1:2 Teeth

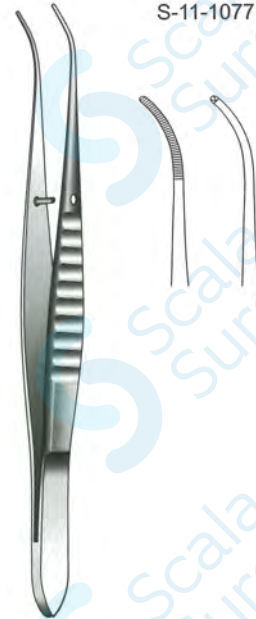

Iris
S-11-1089 4", 10 cm
S-11-1090 4½", 11.5 cm
Curved, Serrated
S-11-1091 4", 10 cm
S-11-1092 4½", 11.5 cm
Curved, 1:2 Teeth



Jackson Burrows

S-11-1093
5½", 14 cm
Serrated Jaw
1:2 Teeth



Jackson Burrows

S-11-1094
5½", 14 cm
Tongue & Groove in
Jaw



Jean

S-11-1100	Serrated	S-11-1101
S-11-1102	1:2 Teeth	S-11-1103
S-11-1104	2:3 Teeth	S-11-1105
5½", 14 cm		7", 18 cm

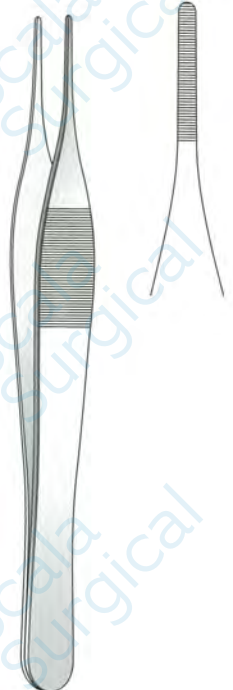

Jefferson

S-11-1106	Serrated
S-11-1107	1:2 Teeth
7", 18 cm	



Kurihara

S-11-1120 Stainless Finish
S-11-1121 Black Finish
10", 25.5 cm
Endo-Cervical, Cross Action

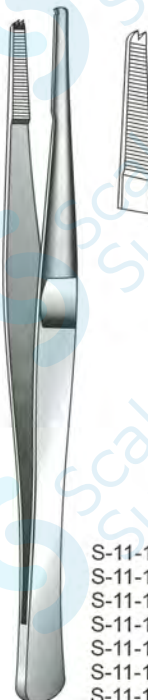

Lane

S-11-1126	Serrated	5", 13 cm
S-11-1127	Serrated	5½", 14 cm
S-11-1128	1:2 Teeth	5", 13 cm
S-11-1129	1:2 Teeth	5½", 14 cm
S-11-1130	1:2 Teeth	6", 15 cm
S-11-1131	1:2 Teeth	7", 18 cm
S-11-1132	1:2 Teeth	8", 20 cm



Lane

S-11-1134	5½", 14 cm
S-11-1135	6", 15 cm
S-11-1136	7", 18 cm
S-11-1137	8", 20 cm
	2:3 Teeth

Dissecting Forceps



Lane

- S-11-1141 6", 15 cm
- S-11-1142 7", 18 cm
- S-11-1143 8", 20 cm
- 3:4 Teeth



Leedham Green

- S-11-1144 2:3 Teeth, 5 1/4", 14.5 cm
- S-11-1145 3:4 Teeth, 5 1/4", 14.5 cm
- S-11-1146 2:3 Teeth, 7", 18 cm



Leeds

- S-11-1147
- 6", 15 cm

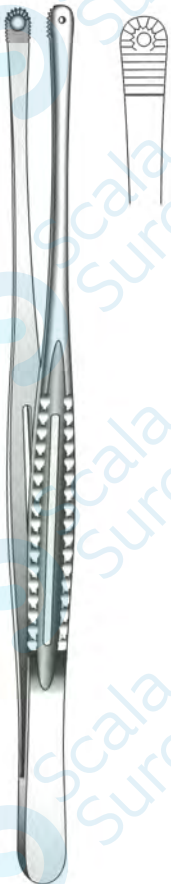

Mayo

- S-11-1148 6", 15 cm
- S-11-1149 9", 23 cm
- Fenestrated Shaft



Maingot

- S-11-1150
- 11", 28 cm
- Fenestrated



McIndoe

- S-11-1163 Serrated
- S-11-1164 1:2 Teeth
- 6", 15 cm

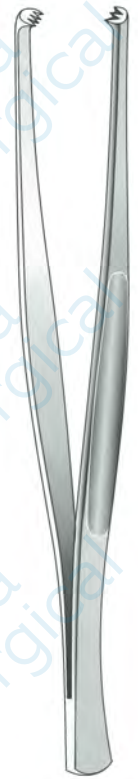

Millin

- S-11-1165
- 9", 23 cm
- 3:4 Teeth



Moorfield
S-11-1168
4½", 11.5 cm
Conjunctival



Moynihan
S-11-1169
7½", 19 cm
Serrated Jaws



Nelson
S-11-1170
9", 23 cm
Adhesion, Non Tearing Teeth



Nicoll
S-11-1175 Serrated
S-11-1176 1:2 Teeth
7", 18 cm
Curved



Officer
S-11-1179 6", 15 cm
S-11-1180 8", 20 cm
S-11-1181 10", 25.5 cm
4:5 Teeth



Penfield
S-11-1183
7", 18 cm

Dissecting Forceps

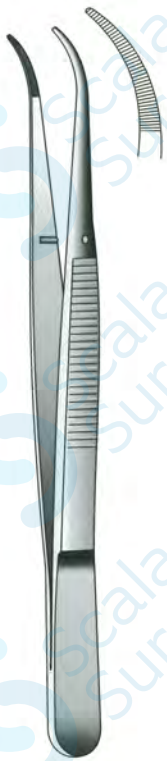

Perry
S-11-1187
5", 13 cm
Fine

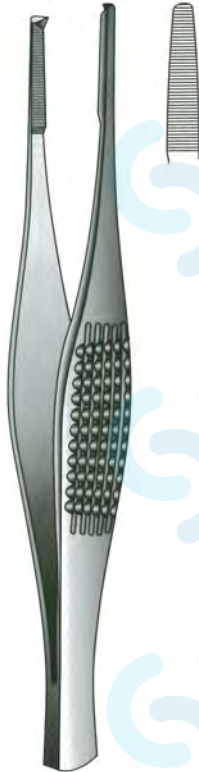

Ramsay
S-11-1190 Serrated
S-11-1191 1:2 Teeth
S-11-1192 2:3 Teeth
7", 18 cm

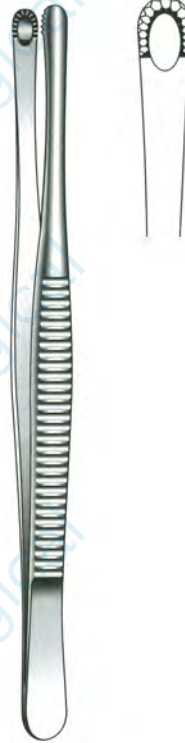

Russian Pattern
S-11-1195 6", 15 cm
S-11-1196 8", 20 cm
S-11-1197 10", 25.5 cm
Semi Circular Jaws



**St. Mark
Hospital Pattern**
S-11-1200 Serrated
S-11-1201 1:2 Teeth
11½", 29 cm



Semkin
S-11-1203 5", 13 cm S-11-1205
S-11-1204 6", 15 cm S-11-1206
Serrated Jaws 1:2 Teeth



Treves
S-11-1210 5", 13 cm
S-11-1211 6", 15 cm
S-11-1212 7", 18 cm
S-11-1213 8", 20 cm
1:2 Teeth



Waugh's
S-11-1214 6", 15 cm
S-11-1215 7", 18 cm
S-11-1216 8", 20 cm
S-11-1217 9", 23 cm
S-11-1218 10", 25.5 cm
Serrated
S-11-1220 6", 15 cm
S-11-1221 7", 18 cm
S-11-1222 8", 20 cm
S-11-1223 9", 23 cm
S-11-1224 10", 25.5 cm
1:2 Teeth

Dissecting Forceps Tungsten Carbide Inserts

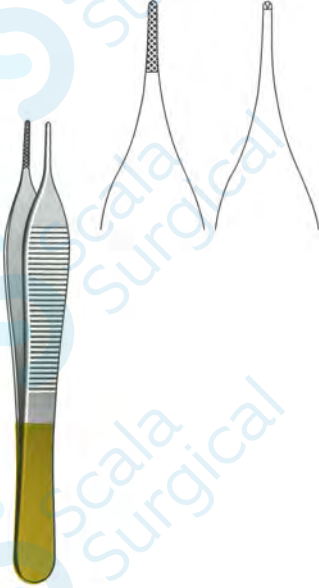

Adson

S-75-0001 Serrated
S-75-0003 1:2 Teeth
4 1/4", 12 cm



Cushing

S-75-0005
7", 18 cm
Straight



Cushing

S-75-0006
7", 18 cm
Angled



Cushing Taylor

S-75-0010
7", 18 cm
Bayonet shape



Potts Smith

S-75-0015 6", 15 cm
S-75-0016 7", 18 cm
S-75-0017 8", 20 cm
S-75-0018 9", 23 cm
S-75-0019 10", 25.5 cm



DeBakey

S-75-0025 6", 15 cm
S-75-0026 7", 18 cm
S-75-0027 8", 20 cm
S-75-0028 9", 23 cm
S-75-0029 10", 25.5 cm



Oehler

S-75-0035 6", 15 cm
S-75-0036 7", 18 cm
S-75-0037 8", 20 cm
S-75-0038 9", 23 cm
S-75-0039 10", 25.5 cm
1:2 Teeth

Epilation (Cilia)



Beer
S-12-1350
3½", 9 cm
Rounded End



Bennet
S-12-1351
3½", 9 cm
Circular Jaws



Douglas
S-12-1352
3½", 9 cm
Straight End



Whitfield
S-12-1353
3½", 9 cm
Oblique End

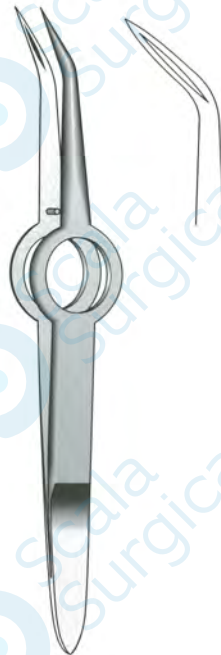

Schaff
S-12-1354
3½", 9 cm
Pointed, Angled Jaws



Barraquer
S-12-1355
4¼", 10.5 cm

Splinter Forceps



Fine Pointed

- S-13-1375 3½", 9 cm
 - S-13-1376 4", 10 cm
 - S-13-1377 4½", 11.5 cm
 - S-13-1378 5", 13 cm
- Straight

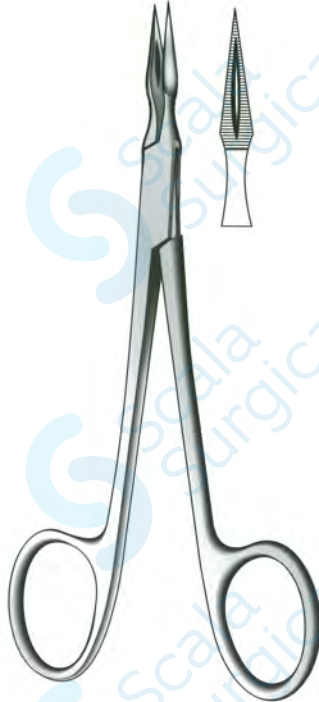

Arthur

- S-13-1390 Straight
 - S-13-1393 Angled
- 5½", 14 cm



Carmalt

- S-13-1395 4½", 11.5 cm
 - S-13-1396 5", 13 cm
 - S-13-1397
 - S-13-1398
- Straight Curved



Hunter

- S-13-1400
- 4½", 11.5 cm
Straight



Hunter

- S-13-1401
- 4½", 11.5 cm
Curved

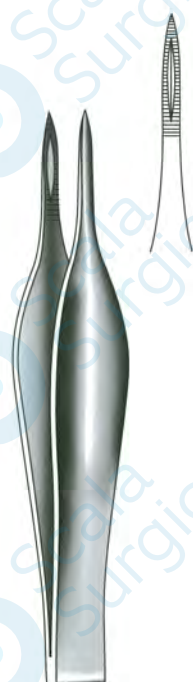

Martin

- S-13-1405 3", 7.5 cm
 - S-13-1406 4½", 11.5 cm
 - S-13-1407 5", 13 cm
- Straight, Feilchenfeld

Splinter Forceps

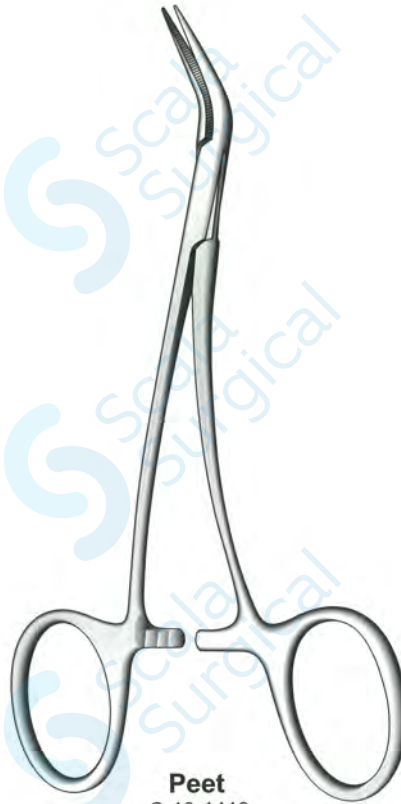

Peet
S-13-1410
4½", 11.5 cm



Ralk
S-13-1411 Straight
S-13-1412 Curved
5½", 14 cm

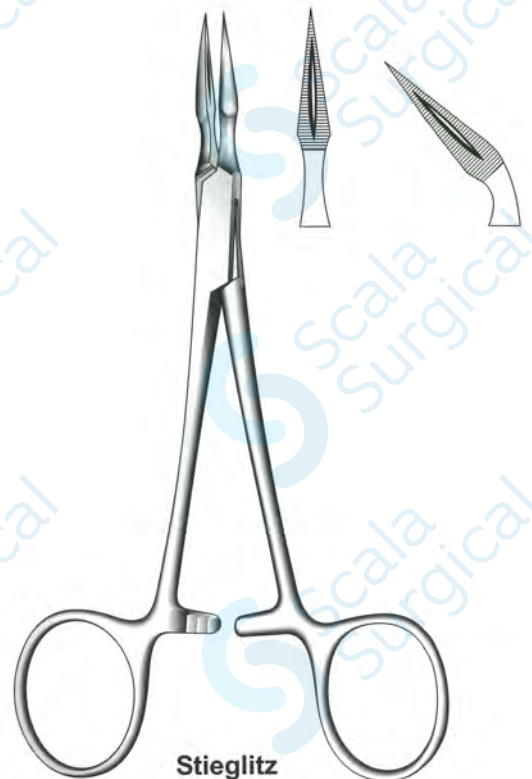

Stieglitz
S-13-1415 Straight
S-13-1416 Curved
5½", 14 cm

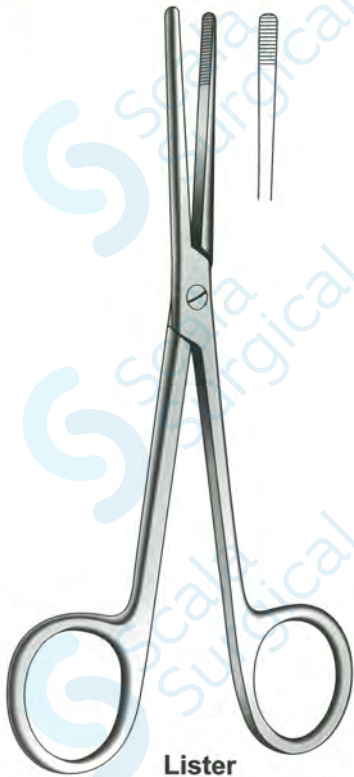

Lister

- S-14-1451 5", 13 cm
- S-14-1452 6", 15 cm
- S-14-1453 7", 18 cm
- S-14-1454 8", 20 cm
- Screw Joint, Straight



Lister

- S-14-1455 5", 13 cm
- S-14-1456 6", 15 cm
- S-14-1457 7", 18 cm
- S-14-1458 8", 20 cm
- Box Joint, Straight



Bryant

- S-14-1465 Box Joint
- S-14-1466 Screw Joint
- S-14-1467 Screw Joint, Open Flat
- 5", 13 cm

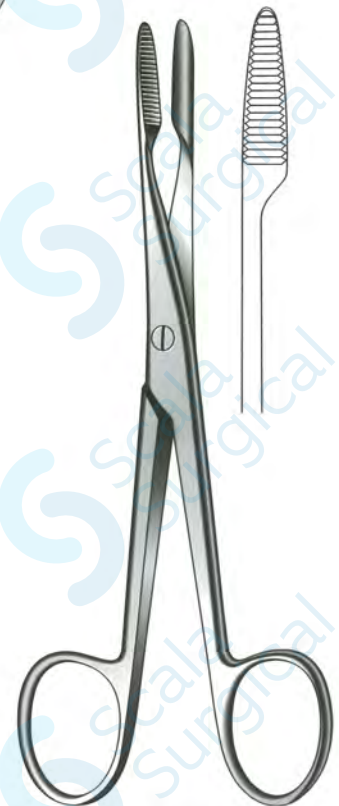

French Pattern

- S-14-1468 Box Joint
- S-14-1469 Screw Joint
- S-14-1470 Screw Joint, Open Flat
- 5", 13 cm

Sponge Holding & Dressing Forceps

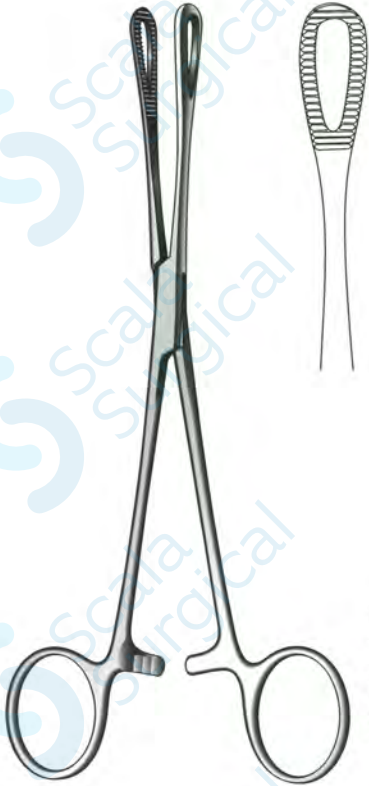

Rampley

- S-16-1480 7", 18 cm
- S-16-1482 9½", 24 cm
- Screw Joint
- S-16-1483 7", 18 cm
- S-16-1484 9½", 24 cm
- S-16-1485 12", 30 cm
- Box Joint



- Foerster**
S-16-1488
9½", 24 cm
Atraumatic Jaws

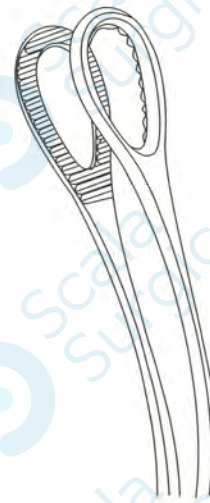
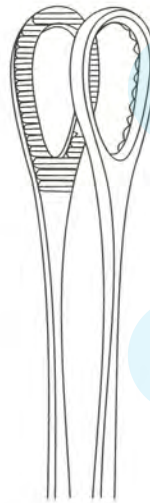
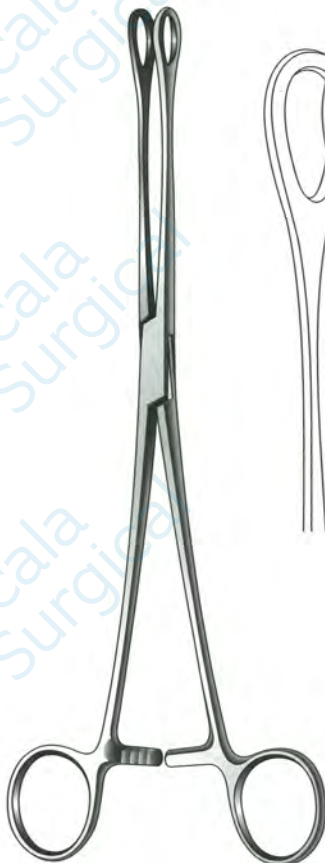

Foerster

- | | |
|----------------------|-------------------|
| S-16-1489 7", 18 cm | S-16-1492 |
| S-16-1490 9½", 24 cm | S-16-1493 |
| S-16-1491 11", 28 cm | |
| Serrated | |
| S-16-1494 7", 18 cm | S-16-1496 |
| S-16-1495 9½", 24 cm | S-16-1497 |
| Straight | Plain Jaws Curved |

Sponge Holding & Dressing Forceps

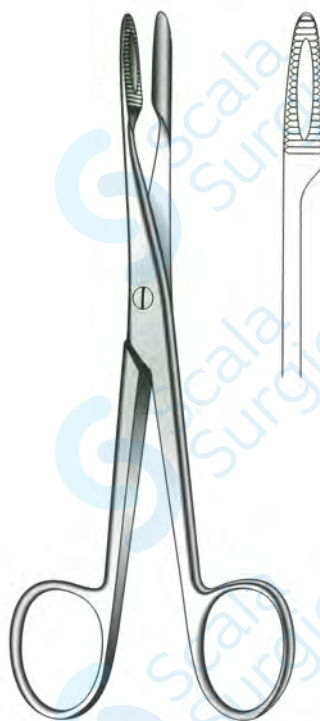

Gross

S-16-1500 6¼", 16 cm
 S-16-1501 7", 18 cm
 S-16-1502 8", 20 cm
 Straight

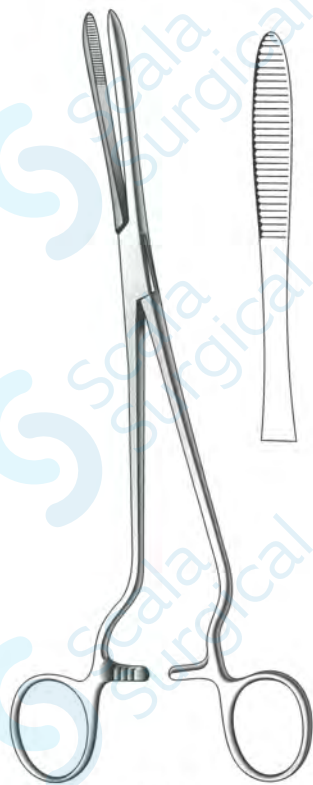

Collin

S-16-1505
 8", 20 cm

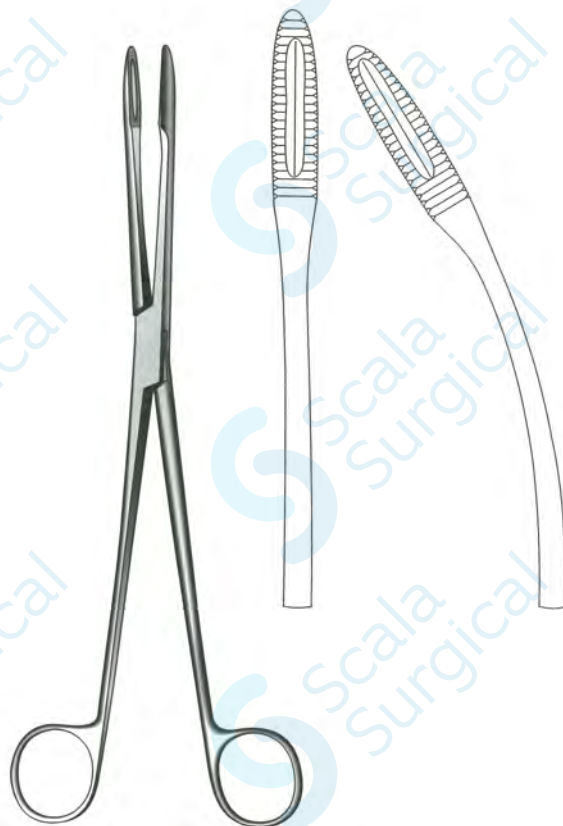

Maier

S-16-1525 8¾", 22 cm S-16-1527
 S-16-1526 10", 25.5 cm S-16-1528
 Straight Curved

Towel Clips

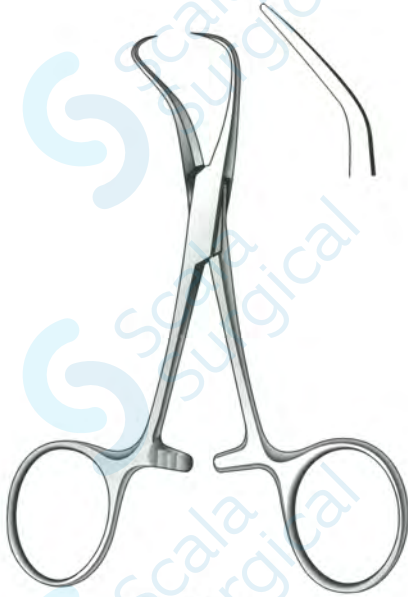

Backhaus

S-17-1540 3½", 9 cm S-17-1550
 S-17-1541 4½", 11.5 cm S-17-1551
 S-17-1542 5¼", 13.5 cm S-17-1552
 Box Joint Screw Joint



Mayo Backhaus

S-17-1553
 5¼", 13.5 cm

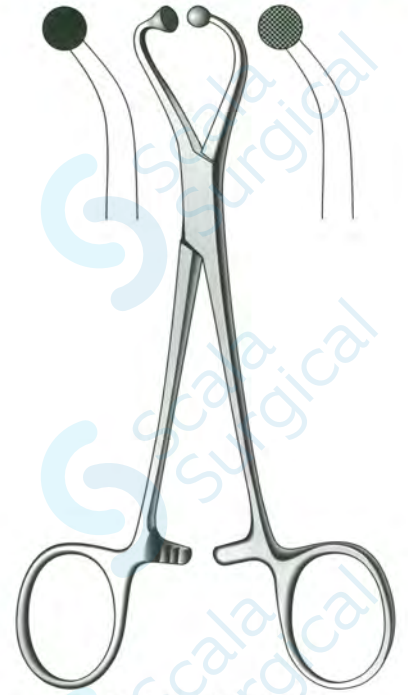

Ball And Socket

S-17-1558 3½", 9 cm
 S-17-1559 4", 10 cm
 S-17-1560 4½", 11.5 cm
 S-17-1561 5", 13 cm
 S-17-1562 5½", 14 cm
 Non-Tearing

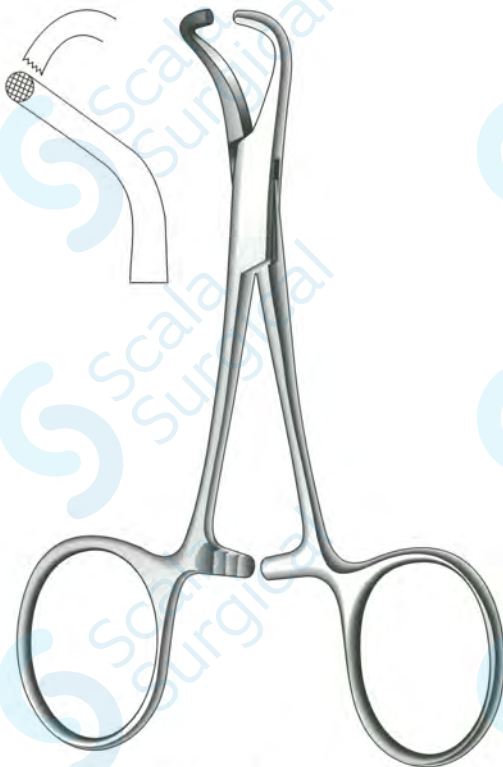

Serrated Jaws

S-17-1563 4", 10 cm
 S-17-1564 4½", 11.5 cm
 S-17-1565 5½", 14 cm
 Non-Tearing

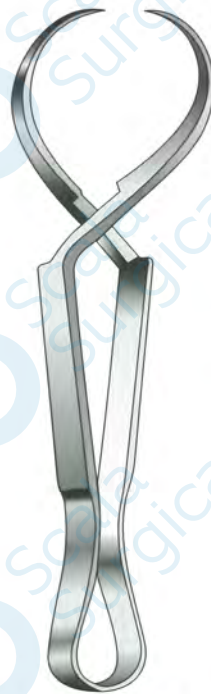

English Pattern

S-17-1567
 3½", 9 cm
 Cross Action



Jones

S-17-1568
 3½", 9 cm
 Cross Action

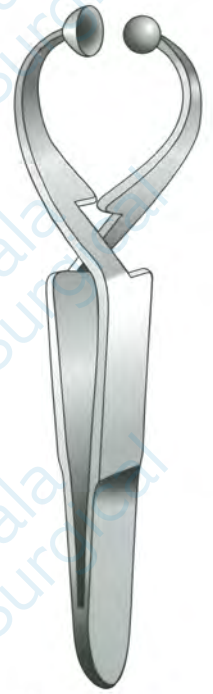

Non-Tearing

S-17-1569
 3½", 9 cm
 Cross Action



Schaedel
S-17-1570
3½", 9 cm
Cross Action



Doyen
S-17-1571
5½", 14 cm
Cross Action



Duff
S-17-1572
3¾", 9.5 cm
Screw Joint

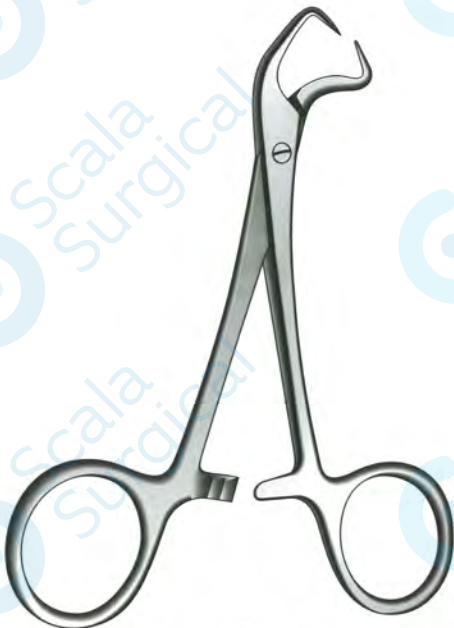

Higgs
S-17-1573
4", 10 cm
Screw Joint, Angled



Lorna
S-17-1574
5½", 14 cm
Box Joint

Towel Clips

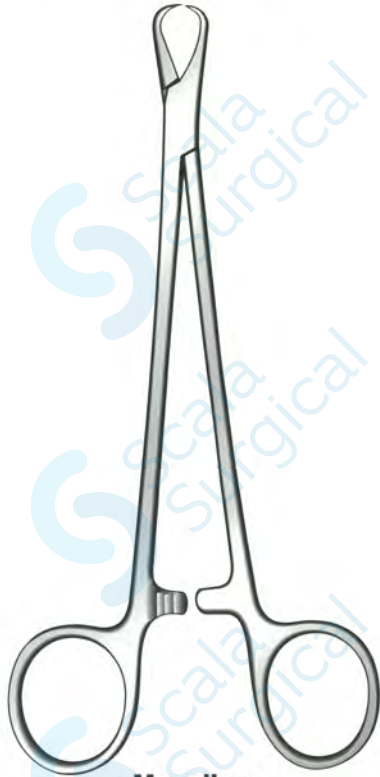

Moynihan
S-17-1575
7", 18 cm
Box Joint, Single Tetra

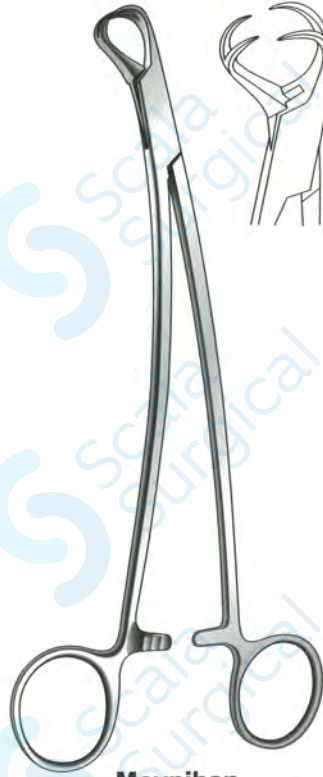

Moynihan
S-17-1576 Screw Joint
S-17-1577 Box Joint
7", 18 cm
Double Tetra



Roeder
S-17-1580 5", 13 cm
S-17-1581 6", 15 cm
Box Joint



Robin Anchoring
S-17-1585 5 mm dia
S-17-1586 13 mm dia
S-17-1587 25 mm dia
5", 13 cm
Screw Joint

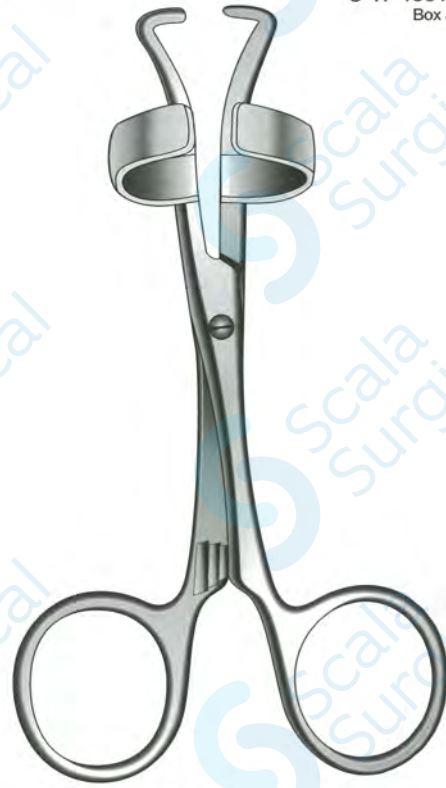

Robin Anchoring
S-17-1588 5 mm dia
S-17-1589 13 mm dia
S-17-1590 25 mm dia
5", 13 cm
Screw Joint, Non-Tearing



Victor (Reverdin Bonney)

- S-18-1640 Handle with 3 Needles
- S-18-1641 Small Needle
- S-18-1642 Medium Needle
- S-18-1643 Large Needle

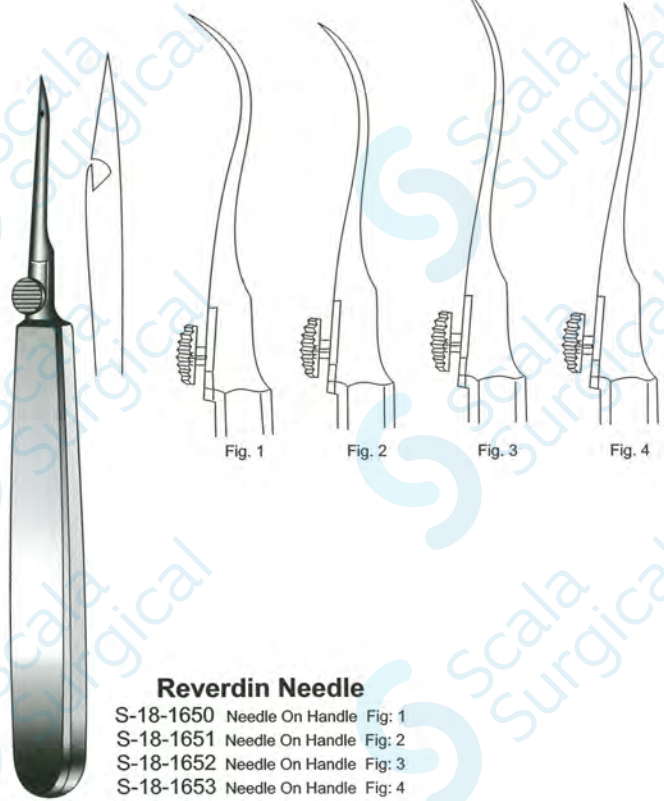

Reverdin Needle

- S-18-1650 Needle On Handle Fig: 1
- S-18-1651 Needle On Handle Fig: 2
- S-18-1652 Needle On Handle Fig: 3
- S-18-1653 Needle On Handle Fig: 4

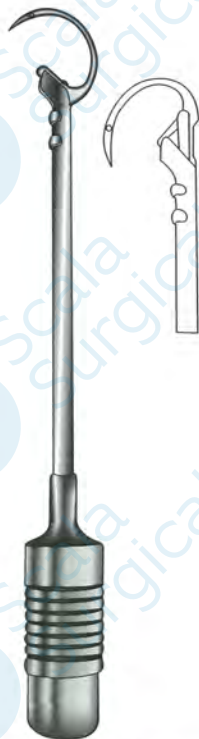

Milin Boomerang

- S-18-1655 Handle with 2 Needles
- S-18-1656 Small Needle
- S-18-1657 Large Needle



Young Boomerang

- S-18-1660 Handle with 3 Needles
- S-18-1661 Small Needle
- S-18-1662 Medium Needle
- S-18-1663 Large Needle

Needle Holders



Baumgartner

S-18-1670
5½", 14.5 cm

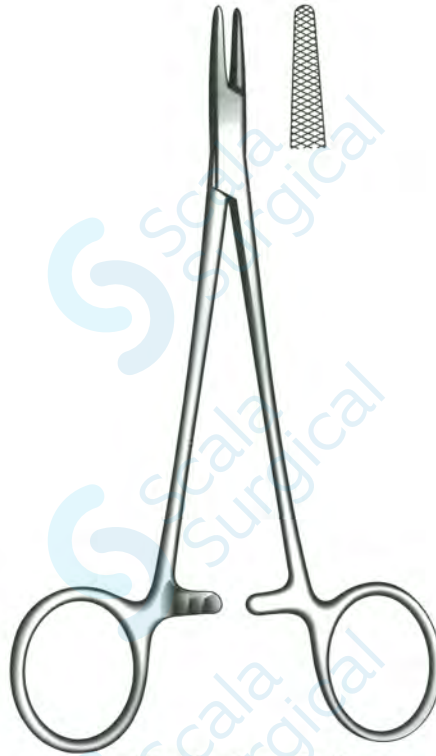

Birmingham Pattern

S-18-1671 Screw Joint
S-18-1672 Box Joint
8", 20 cm
Curved Shanks



Blalock

S-18-1673 7¼", 18.5 cm
S-18-1674 10½", 26.5 cm
Half Serrated Jaws
Box Joint

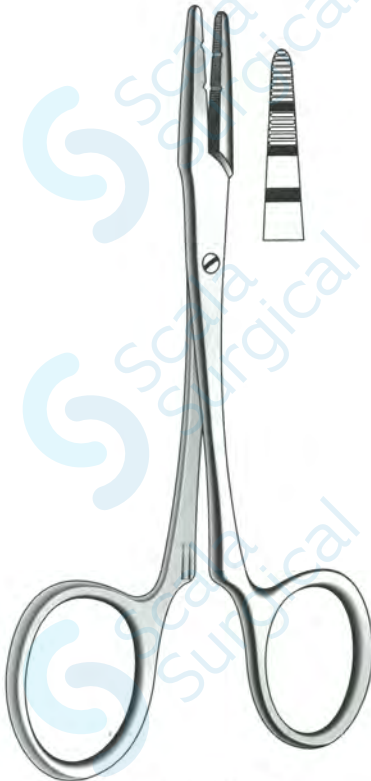

Bruce Clark

S-18-1675
5", 13 cm
Screw Joint

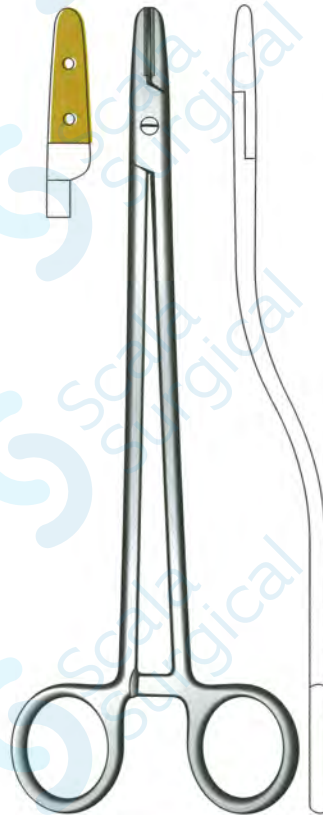

Bozemann

S-18-1676
8", 20 cm
Copper Lined Jaws
Box Joint

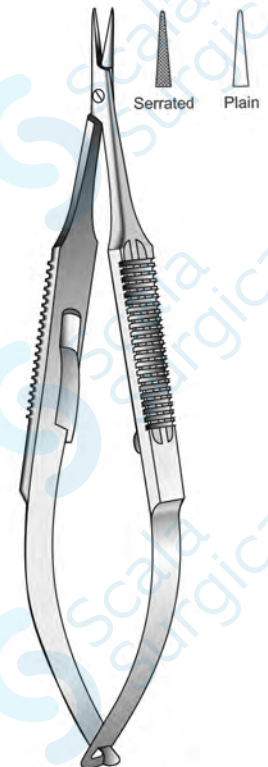

Castroviejo

S-18-1679 Serrated
S-18-1680 Plain
5", 13 cm
Spring Action



Converse
S-18-1681
4½", 11.5 cm
Longitudinal serration

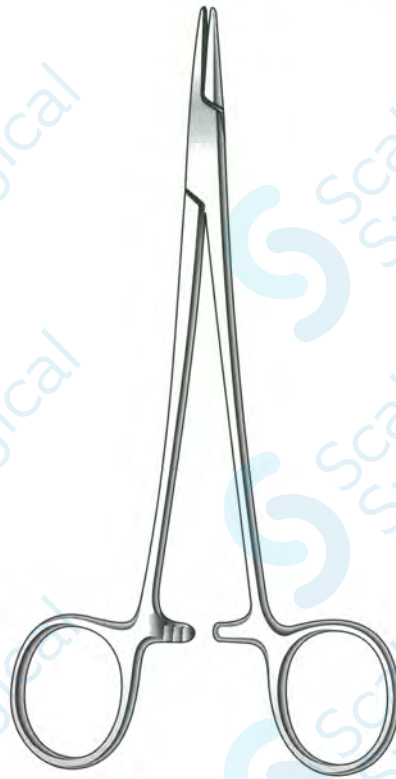

Crile Murray
S-18-1683
6", 15 cm



Crile Wood
S-18-1684 6", 15 cm
S-18-1685 7", 18 cm
S-18-1686 8", 20 cm

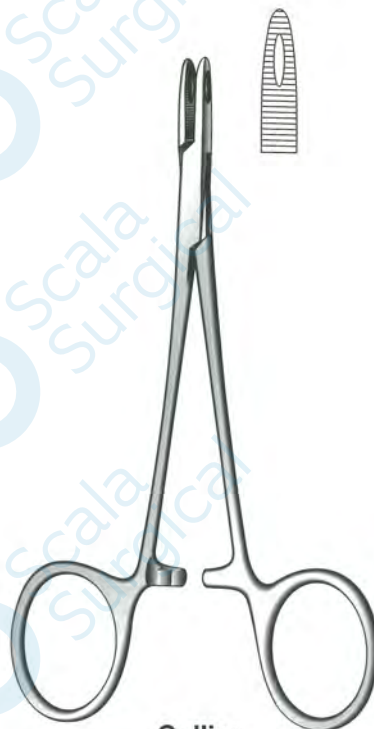

Collier
S-18-1687
5", 13 cm



Derf
S-18-1691
4¾", 12 cm

Needle Holders

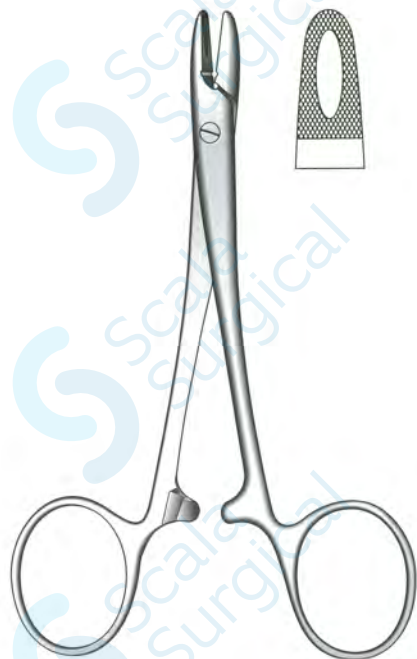

Doyen
S-18-1692
5", 13 cm



Finochietto
S-18-1705
10", 25.5 cm

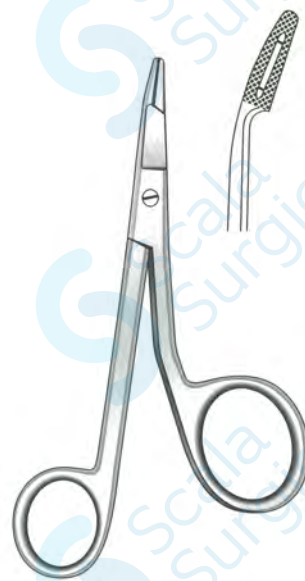

Foster Gillies
S-18-1706
5 1/4", 13.5 cm
Combined with Scissors

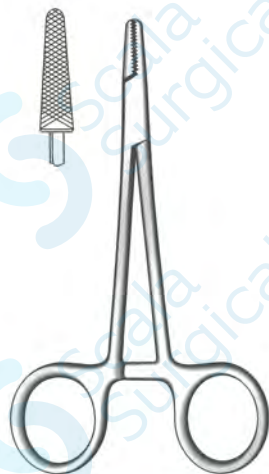

Fry
S-18-1707
4 1/2", 11.5 cm

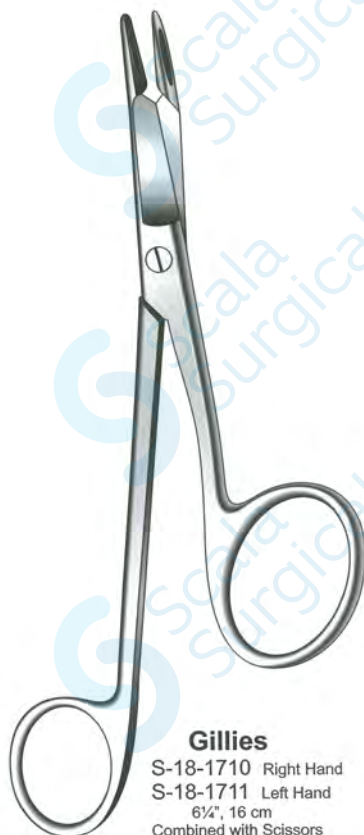

Gillies
S-18-1710 Right Hand
S-18-1711 Left Hand
6 1/2", 16 cm
Combined with Scissors

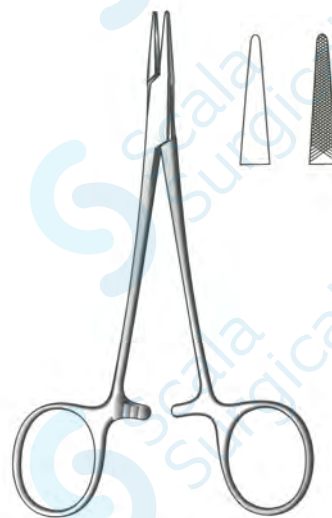

Halsey
S-18-1712 Smooth Jaws
S-18-1713 Serrated Jaws
5", 13 cm

Needle Holders

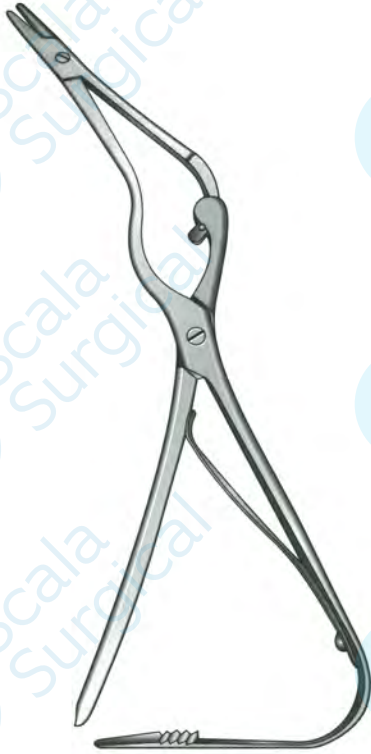

Halsted
S-18-1714
8 1/2", 21.5 cm
Multiple Action



Heaney
S-18-1715 8", 20 cm
S-18-1716 10", 25.5 cm

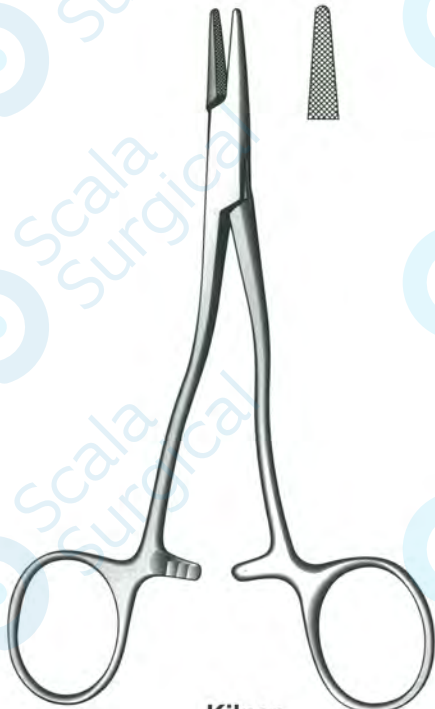

Kilner
S-18-1718 5 1/4", 13.5 cm
S-18-1719 6", 15 cm

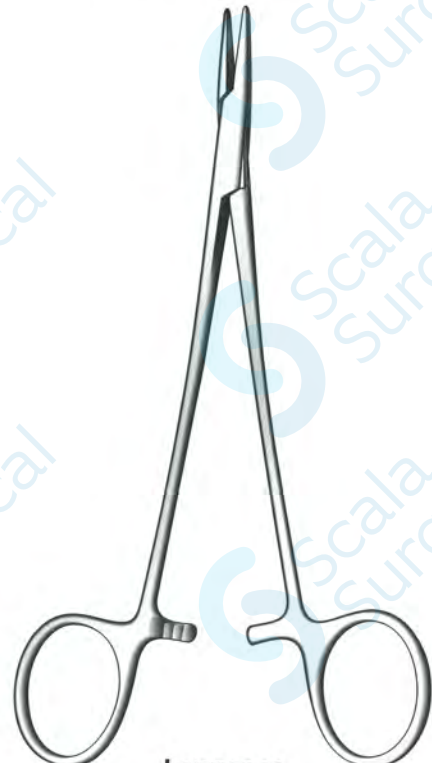

Lawrence
S-18-1722
6", 15 cm

Needle Holders

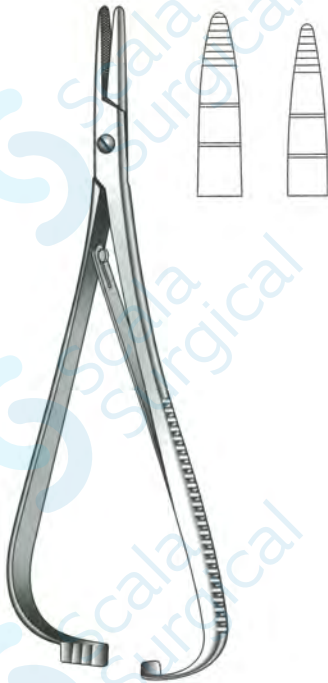

Mcphail

- S-18-1725 6", 15 cm
- S-18-1726 7", 18 cm
- S-18-1727 8", 20 cm
- Copper Lined Jaws, Box Joint
- S-18-1728 6", 15 cm
- S-18-1729 7", 18 cm
- S-18-1730 8", 20 cm
- Copper Lined Jaws, Screw Joint



Mathieu

- S-18-1750 5½", 14 cm
- S-18-1751 6½", 16.5 cm
- S-18-1752 8", 20 cm
- Box Joint
- S-18-1755
- S-18-1756
- S-18-1757
- Screw Joint



Metzenbaum

- S-18-1760
- 7", 18 cm
- Fenestrated Jaws

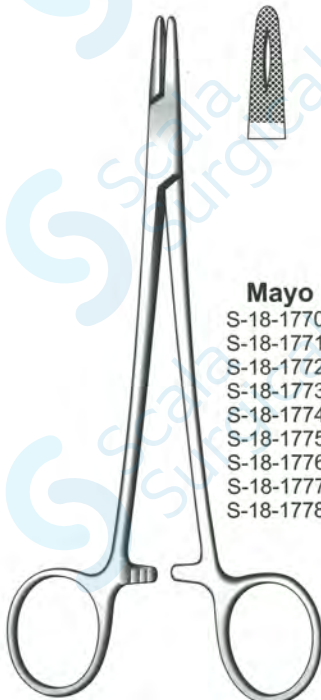

Mayo Heger

- S-18-1770 5", 13 cm
- S-18-1771 5½", 14 cm
- S-18-1772 6", 15 cm
- S-18-1773 6½", 16 cm
- S-18-1774 7", 18 cm
- S-18-1775 7½", 19 cm
- S-18-1776 8", 20 cm
- S-18-1777 9½", 24 cm
- S-18-1778 12", 30.5 cm



Mayo Rochester

- S-18-1781 7", 18 cm
- S-18-1782 8", 20 cm
- S-18-1783 9", 23 cm

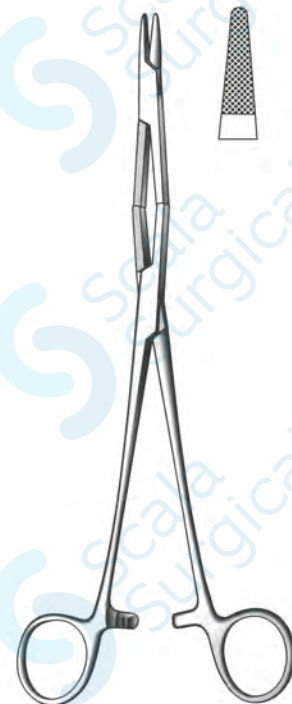

Naunton Morgan

- S-18-1785 7", 18 cm
- S-18-1786 10", 25.5 cm
- Multiple Action

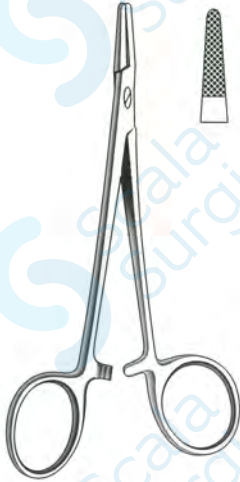

Nievert
S-18-1787
5", 13 cm
Off Set Rings

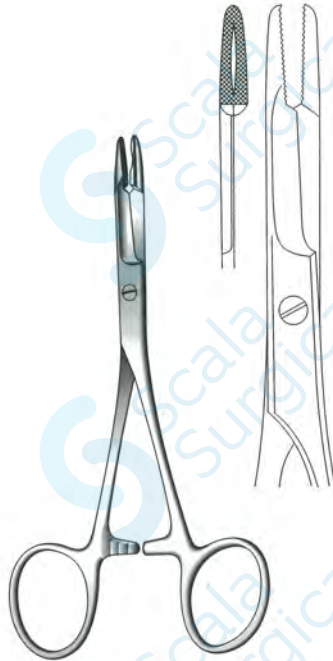

Olsen-Hegar
S-18-1790 5½", 14 cm
S-18-1791 6¼", 16 cm
S-18-1792 7", 18 cm
Combined with Scissors



Sarot
S-18-1800 7", 18 cm
S-18-1801 10", 25.5 cm



Sims
S-18-1809 Straight Shanks
S-18-1810 Curved Shanks
7 ½", 19 cm



Thomson Walker
S-18-1820 Straight Shanks
S-18-1821 Curved Shanks
8", 20 cm



Turner Warwick
S-18-1822
9", 23 cm

Needle Holders



Wangenstein
S-18-1825
10¼", 27.5 cm



Ward
S-18-1826
7", 18 cm

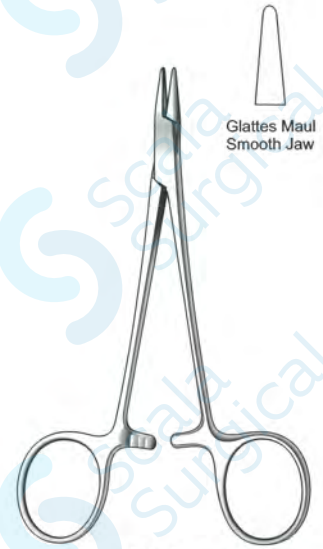

Glattes Maul
Smooth Jaw

Webster
S-18-1827
5¼", 13.5 cm

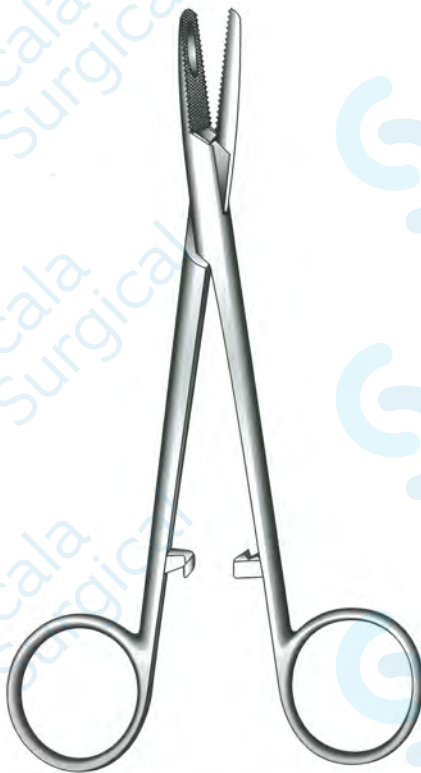

Wright
S-18-1828
5", 13 cm



Wertheim
S-18-1829
8", 20 cm

Tungsten Carbide Needle Holders



Barraquer
S-80-7500
5", 13 cm
Spring Action
With Lock Curved

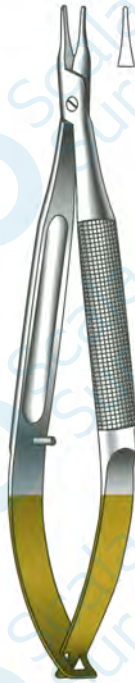

Barraquer
S-80-7501
5", 13 cm
Spring Action
Without Lock, Straight



Barraquer
S-80-7502
5", 13 cm
Spring Action
Without Lock, Curved



Castroviejo
S-80-7504
5½", 14 cm
Spring Action
With Lock, Straight



Castroviejo
S-80-7505
5½", 14 cm
Spring Action
Without Lock, Straight

Tungsten Carbide Needle Holders



Baumgartner
S-80-7506
8", 20 cm



Berry
S-80-7508
7 1/4", 18.5 cm

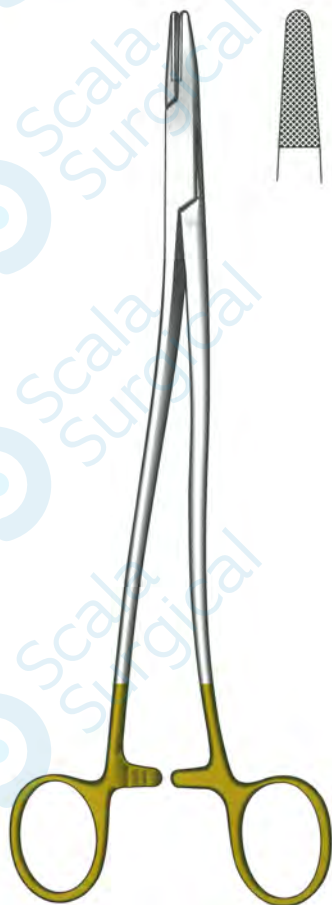

Bozemann
S-80-7509
8", 20 cm



Crile-Wood
S-80-7510 5 1/2", 14 cm
S-80-7511 6", 15 cm
S-80-7512 7", 18 cm
S-80-7513 8", 20 cm
S-80-7514 9", 23 cm
S-80-7515 10", 25.5 cm
S-80-7516 12", 30.5 cm



DeBakey

S-80-7520 6", 15 cm
 S-80-7521 7", 18 cm
 S-80-7522 8", 20 cm
 S-80-7523 9", 23 cm
 S-80-7524 10", 25.5 cm
 S-80-7525 12", 30.5 cm

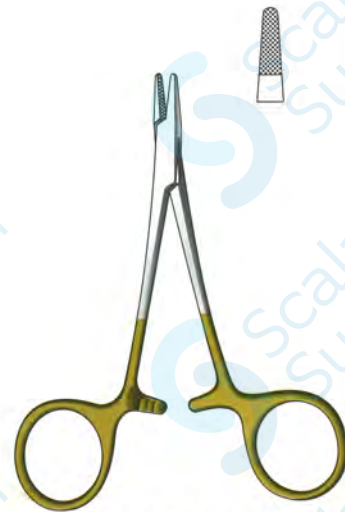

Derf

S-80-7530
 4 1/2", 12 cm

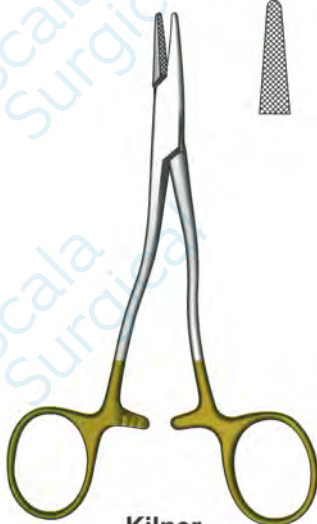

Kilner

S-80-7535
 5 1/2", 13.5 cm



Foster Gillies

S-80-7536
 4 1/2", 11 cm

Tungsten Carbide Needle Holders



Mini Foster Gillies
S-80-7537
4", 10 cm

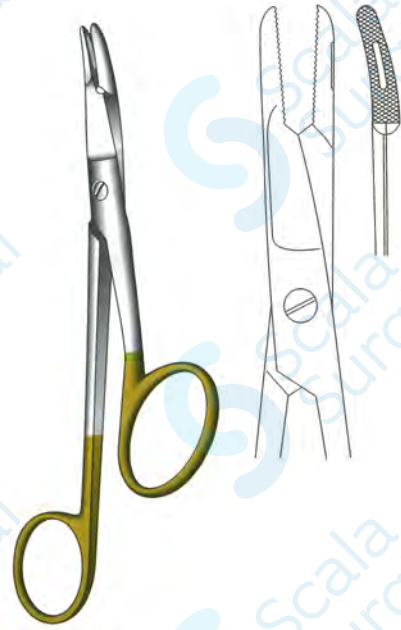

Gillies
S-80-7540
6 1/4", 16 cm



Halsey
S-80-7545 Serrated Jaws
S-80-7546 Smooth Jaws
5", 13 cm



Heaney
S-80-7548 8", 20 cm
S-80-7549 10", 25.5 cm

Tungsten Carbide Needle Holders

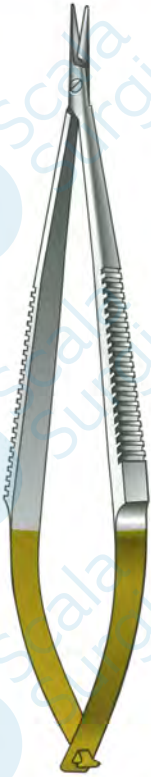

Jacobson
S-80-7550
7¼", 18.5 cm
Without Lock

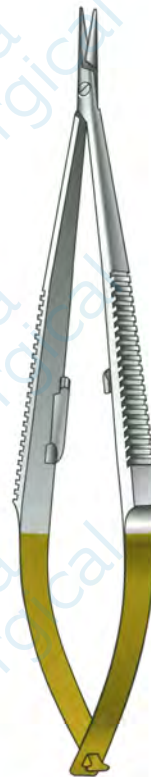

Jacobson
S-80-7551
7¼", 18.5 cm
With Lock



Kalt
S-80-7558
5½", 14 cm



Silcock Stevens
S-80-7560
5½", 14 cm

Tungsten Carbide Needle Holders

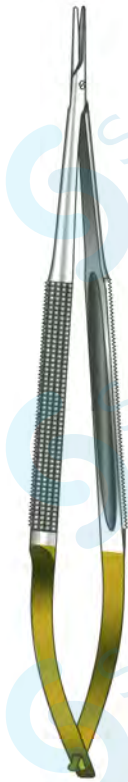

Micro
S-80-7561
8½", 21 cm
Straight



Micro
S-80-7562
8½", 21 cm
Curved

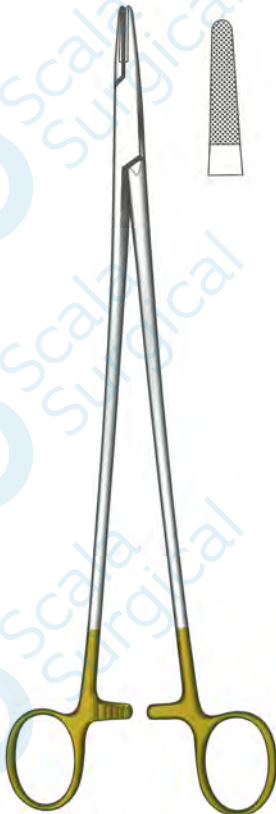

Mason
S-80-7563
10½", 26.5 cm



Mayo Hegar

- S-80-7564 5", 13 cm
- S-80-7565 5½", 14 cm
- S-80-7566 6", 15 cm
- S-80-7567 7", 18 cm
- S-80-7568 8", 20 cm
- S-80-7569 9", 23 cm
- S-80-7570 10", 25.5 cm
- S-80-7571 11", 28 cm
- S-80-7572 12", 30.5 cm
- S-80-7573 14", 35.5 cm

Tungsten Carbide Needle Holders

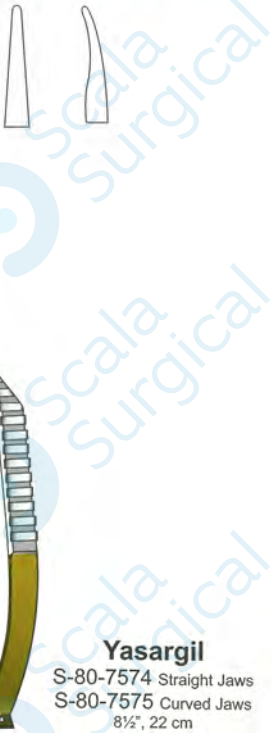

Yasargil
S-80-7574 Straight Jaws
S-80-7575 Curved Jaws
8½", 22 cm



Julian
S-80-7576
8", 20 cm



Mathieu
S-80-7577 6½", 17 cm
S-80-7578 7", 18 cm
S-80-7579 8", 20 cm

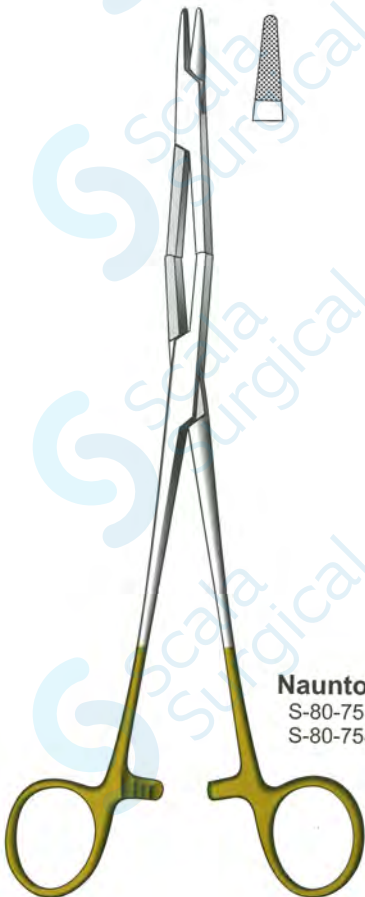

Naunton Morgan
S-80-7580 8", 20 cm
S-80-7581 10", 25.5 cm



Lawrance
S-80-7582
6", 15 cm



Olsen Hegar
S-80-7583 5½", 14 cm
S-80-7584 6½", 16 cm
S-80-7585 7", 18 cm

Tungsten Carbide Needle Holders

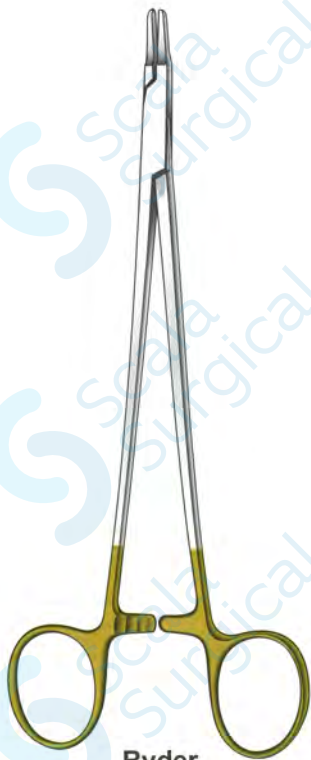

Ryder

- S-80-7587 5", 13 cm
- S-80-7588 6", 15 cm
- S-80-7589 7", 18 cm
- S-80-7590 8", 20 cm
- S-80-7591 9", 23 cm



Mini Ryder

- S-80-7592 5", 13 cm
- S-80-7593 6", 15 cm
- S-80-7594 7", 18 cm
- S-80-7595 8", 20 cm
- S-80-7596 9", 23 cm



Sarot

- S-80-7597
- 7", 18 cm

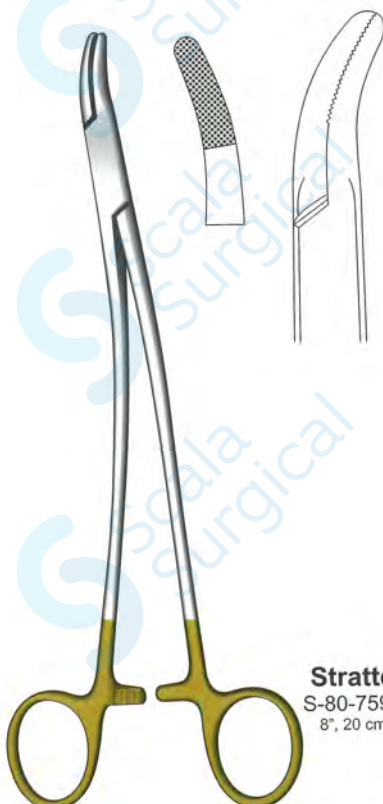

Stratte

- S-80-7598
- 8", 20 cm

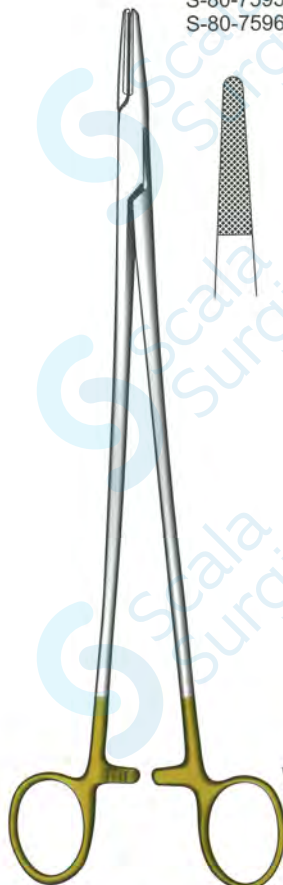

Wangenstein

- S-80-7599
- 10 1/4", 27 cm



Webster

- S-80-7600
- 5", 13 cm

Tungsten Carbide Needle Holders



Thomson Walker
S-80-7604
8", 20 cm



Finochietto
S-80-7606 8", 20 cm
S-80-7608 10", 25.5 cm

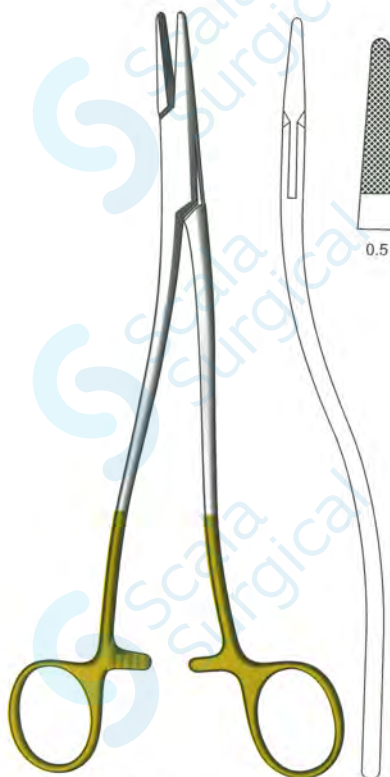

Wertheim
S-80-7610
8", 20 cm

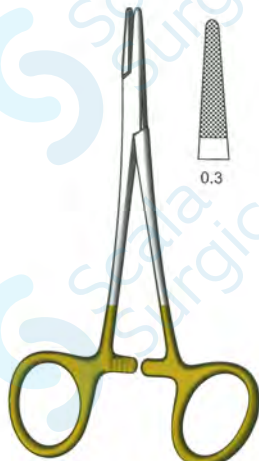

Nievert
S-80-7612
5", 13 cm



Fry
S-80-7616
4 1/2", 11.5 cm

Suture Forceps



Bonney
 S-19-1500 With Rack
 S-19-1501 With Reverse Rack
 6", 15 cm
 Approximating Forceps



Braithwaite
 S-19-1503
 6", 15 cm

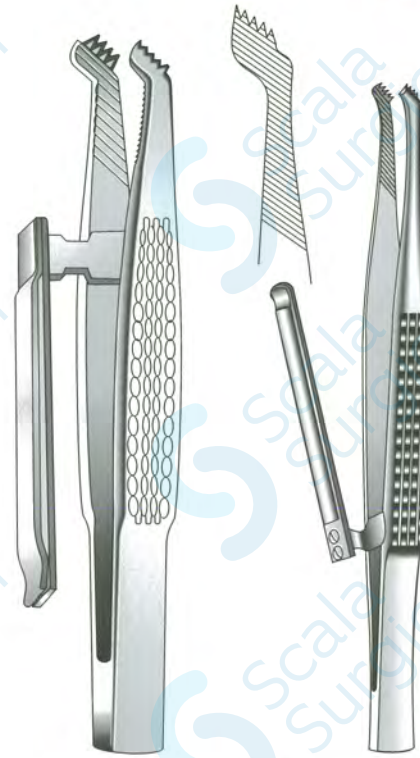

Childe
 S-19-1504 With Rack
 S-19-1505 With Reverse Rack
 7", 18 cm
 Approximating Forceps



Collin (Mitchel)
 S-19-1506
 5", 13 cm
 Screw Joint



Comyns
 S-19-1508
 5 1/2", 14 cm
 3:4 Teeth



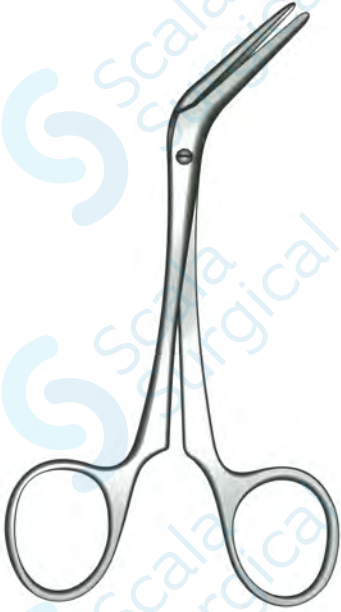

Guys (Galabin)
S-19-1509 5½", 14 cm
S-19-1510 7", 18 cm



Hegenbarth
S-19-1511
4¾", 12 cm



Michel
S-19-1512
5", 13 cm
1:2 Teeth
Approximating



Michel
S-19-1513
5", 13 cm
3:4 Teeth.
Inserting



Michel
S-19-1514
5", 13 cm
Inserting and Extracting

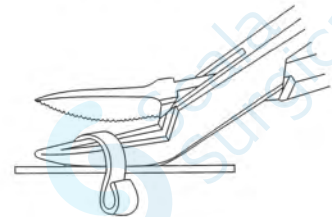

Michel Modif
S-19-1515
5½", 13 cm

Suture Forceps



McGavin
S-19-1516
5", 13 cm
Approximating



Richer
S-19-1517
5 3/4", 13.5 cm
Health

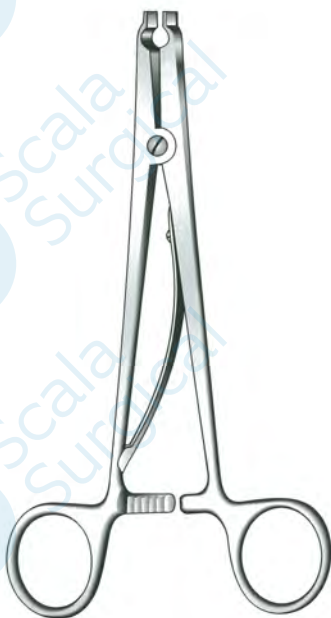

Raney
S-19-1518
6 1/2", 16 cm



Wachenfeldt
S-19-1521
4 3/4", 12 cm

Aneurysm Needles



**Aneurysm
Needle**
S-20-1500
5½", 14 cm
(Curved Laterally)
Flat Handle, Small



**Aneurysm
Needle**
S-20-1501
5½", 14 cm
(Curved Laterally)
Oval Handle, Small



S-20-1502
5½", 14 cm
(Curved Laterally)
Curved to Left
Small



S-20-1503
5½", 14 cm
(Curved Laterally)
Curved to Right
Small



Dupuytren
S-20-1504
7", 18 cm
(Curved Laterally)
Curved to Left



Dupuytren
S-20-1505
7", 18 cm
(Curved Laterally)
Curved to Right



Deschamp
S-20-1508
8½", 21.5 cm
(Curved Laterally)
Curved to Left

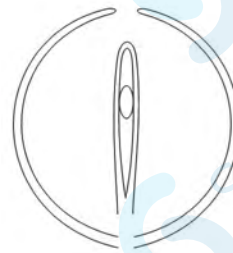

Deschamp
S-20-1509
8½", 21.5 cm
(Curved Laterally)
Curved to Right

Aneurysm Needles



Joll
 S-20-1510 Shallow Curved
 S-20-1511 Medium Curved
 S-20-1512 Deep Curved
 8", 20 cm
 Hollow Handle



Kocher
 S-20-1513
 8", 20 cm
 Hollow Handle



Lahey
 S-20-1514
 Curved to Left
 7", 18 cm



Lahey
 S-20-1515
 Curved to Right
 7", 18 cm

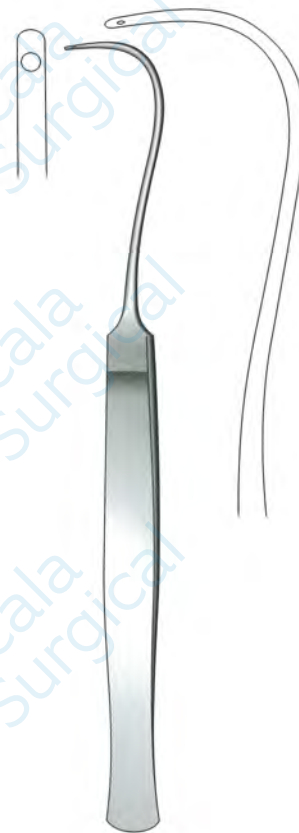

Symes
 S-20-1516
 6 1/4", 16 cm
 Curved Laterally

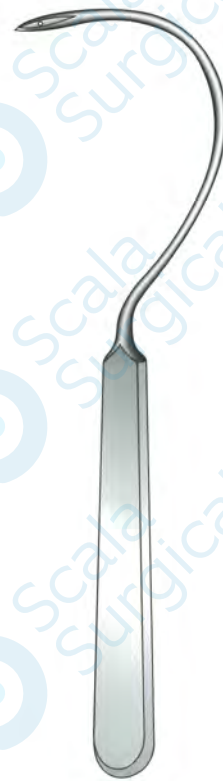

Moynihan
 S-20-1517
 7 1/2", 19 cm

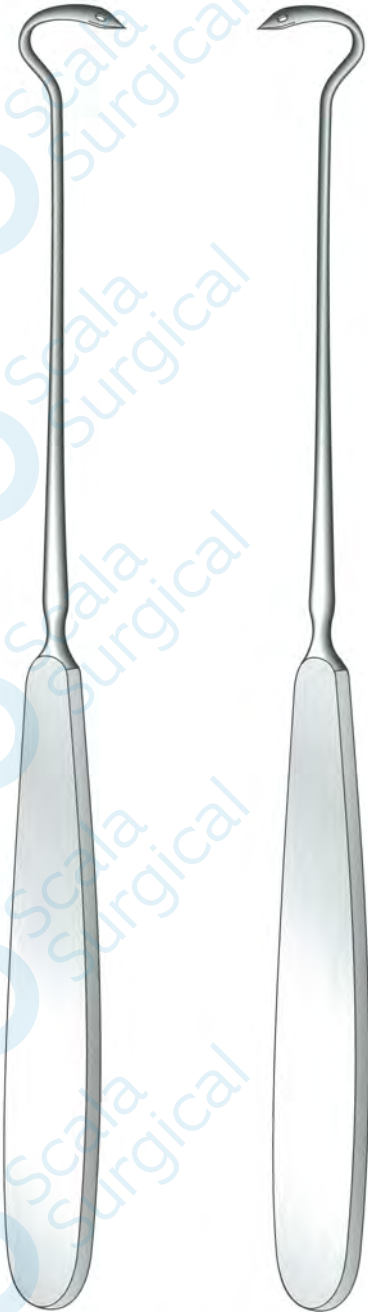

Irwin Moore
S-20-1519
8½", 21 cm
Curved to Left

Irwin Moore
S-20-1520
8½", 21 cm
Curved to Right

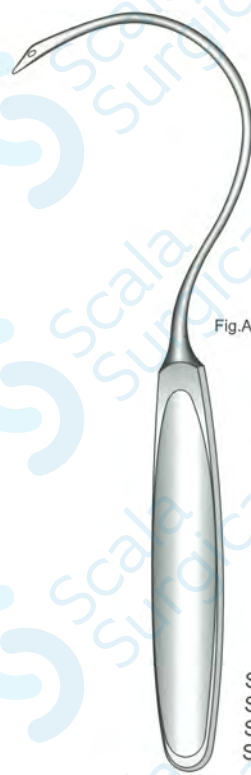

Fig.A



Fig.B



Fig.C

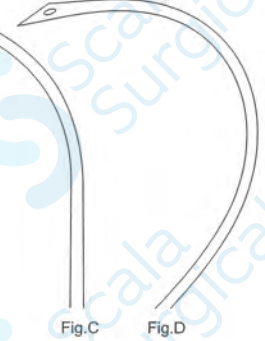

Fig.D

Doyen

- S-20-1521 Fig. A
- S-20-1522 Fig. B
- S-20-1523 Fig. C
- S-20-1524 Fig. D



Negus Knot
S-20-1525
8", 20 cm
Pusher

Probes



Probe with Eye
 S-21-2000 5", 13 cm
 S-21-2001 6", 15 cm
 S-21-2002 7", 18 cm
 S-21-2003 8", 20 cm
 S-21-2004 10", 25.5 cm
 S-21-2005 12", 30.5 cm
 Silver Plated



Probe with Eye
 S-21-2010 5", 13 cm
 S-21-2011 6", 15 cm
 S-21-2012 7", 18 cm
 S-21-2013 8", 20 cm
 S-21-2014 10", 25.5 cm
 S-21-2015 12", 30.5 cm
 Stainless Steel



Probe (Double Ended)
 S-21-2020 5", 13 cm
 S-21-2021 6", 15 cm
 S-21-2022 7", 18 cm
 S-21-2023 8", 20 cm
 S-21-2024 10", 25.5 cm
 S-21-2025 12", 30.5 cm
 Stainless Steel



Bronner
 S-21-2027
 5½", 14 cm



Stacke
 S-21-2028
 4½", 11.5 cm



Jobson Horne
 S-21-2029 5½", 14 cm
 S-21-2030 7", 18 cm



Farrell
 S-21-2031
 6¼", 16 cm

Fistula Directors & Ring Cutter



Brodie

S-21-2050 5", 13 cm
 S-21-2051 5½", 14 cm
 S-21-2052 6¾", 16 cm
 Grooved



Brodie

S-21-2053 5", 13 cm
 S-21-2054 5½", 14 cm
 S-21-2055 6¾", 16 cm
 Grooved with Probe End



Lockhart-Mummery

S-21-2060
 6¾", 16.5 cm
 Straight



Lockhart-Mummery

S-21-2061
 6", 15 cm
 Slight Curved



Lockhart-Mummery

S-21-2062
 5½", 14 cm
 Curved

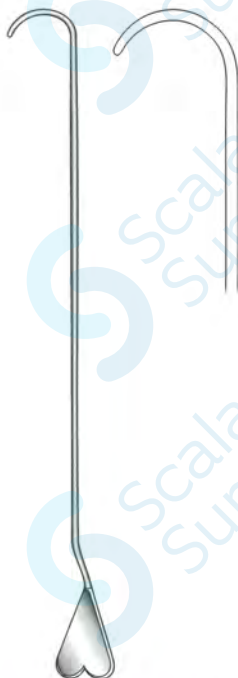

Lockhart-Mummery

S-21-2063
 6¾", 16 cm
 Full Curved



Ring Cutter

S-21-2090 Complete with Blade
 S-21-2091 Without Blade
 6¾", 16 cm

Saw Blade

S-21-2095
 Standard

Retractors

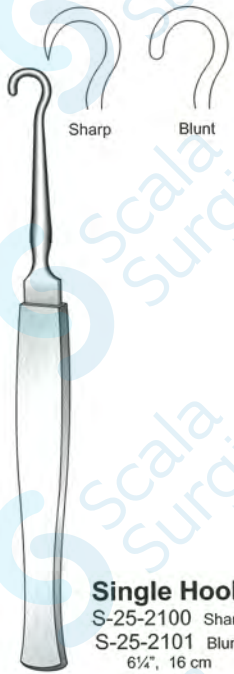

Single Hook
 S-25-2100 Sharp
 S-25-2101 Blunt
 6 1/4", 16 cm

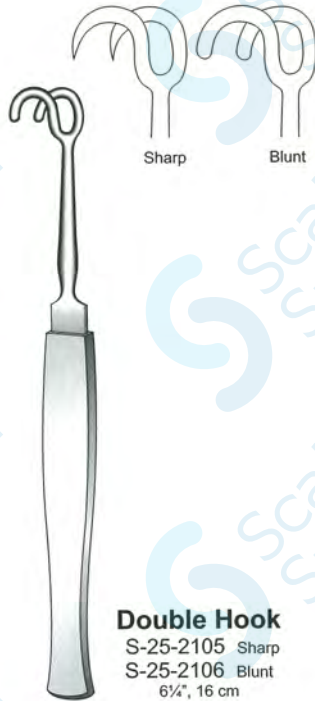

Double Hook
 S-25-2105 Sharp
 S-25-2106 Blunt
 6 1/4", 16 cm



Small Hook
 S-25-2107 1 Prong
 S-25-2108 2 Prong
 S-25-2109 3 Prong
 S-25-2110 4 Prong
 6 1/4", 16 cm
 Sharp



Small Hook
 S-25-2111 1 Prong
 S-25-2112 2 Prong
 S-25-2113 3 Prong
 S-25-2114 4 Prong
 6 1/4", 16 cm
 Blunt



Hook
 S-25-2115 1 Prong
 S-25-2116 2 Prong
 S-25-2117 3 Prong
 S-25-2118 4 Prong
 6 1/4", 16 cm
 Flexible Shaft



Slade
 S-25-2119
 Lung



Allison
 S-25-2120 Infant, 4 1/2" x 2"
 S-25-2121 Child, 6 1/2" x 2"
 S-25-2122 Adult, 7 1/2" x 2"
 Lung

Retractors



Allen
S-25-2123
8", 20 cm
Double Ended

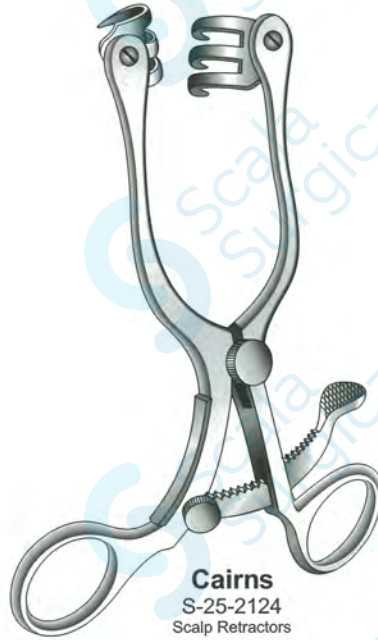

Cairns
S-25-2124
Scalp Retractors



Cairns
S-25-2127 3 Prong
S-25-2128 4 Prong
8 1/4", 21 cm
Rake, Sharp

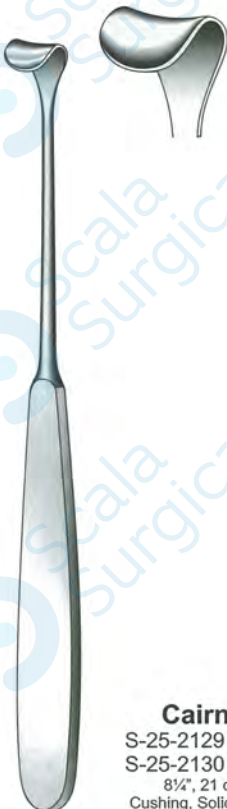

Cairns
S-25-2129 16 mm
S-25-2130 19 mm
8 1/4", 21 cm
Cushing, Solid Blade



Cushing
S-25-2131 No.1, 7+9 mm wide
S-25-2132 No.2, 11+13 mm wide
S-25-2133 No.3, 13+15 mm wide
S-25-2134 No.4, 15+18 mm wide
S-25-2135 No.5, 18+22 mm wide
Malleable, 7", 18 cm

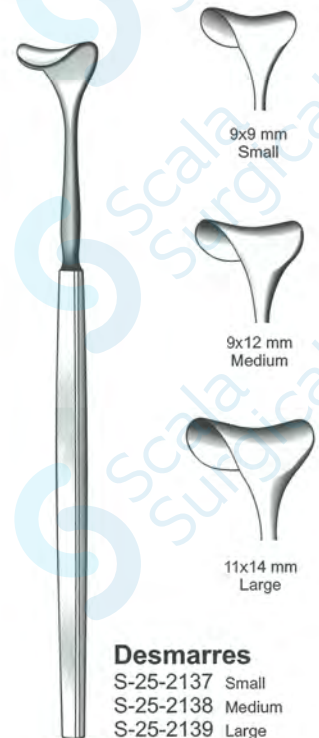

Desmarres
S-25-2137 Small
S-25-2138 Medium
S-25-2139 Large

Retractors



Canny Ryall
S-25-2140
Army Pattern



Canny Ryall
S-25-2141
Navy Pattern

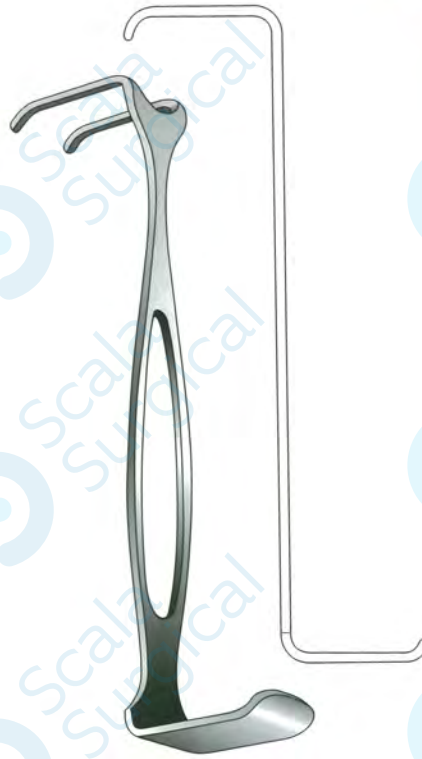

Czerny
S-25-2142
7", 18 cm
Double Ended



Durham
S-25-2144 width 10 mm
S-25-2145 width 13 mm
S-25-2146 width 19 mm
S-25-2147 width 23 mm



Farabeuf (Ollier)
S-25-2148 3 x 1.3 cm
S-25-2149 4 x 2.5 cm
S-25-2150 6 x 3.5 cm
9", 23 cm
Single ended, Double Prongs



Kilner
S-25-2152
Nasal Retractor

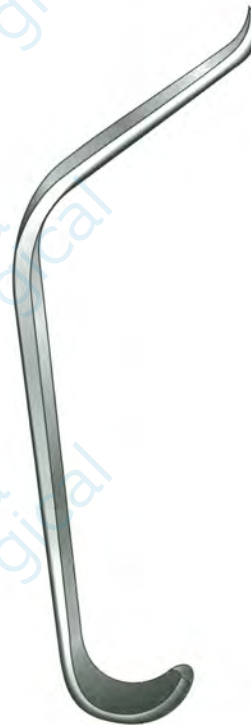

Seldin
S-25-2151
Pyriform Rim



Parker
S-25-2153
5 1/2", 13.5 cm
Set of 2, Double Ended

Retractors



Sternberg

S-25-2155 4¾", 12 cm
S-25-2156 5¼", 13.5 cm



Farabeuf

S-25-2157 Set of 2, 4¾", 12 cm
S-25-2158 Set of 2, 5¼", 13.5 cm
S-25-2159 Set of 2, 6", 15 cm
Double Ended



Hovell Lingual

S-25-2160
9", 23 cm
For lower impact wisdom teeth
110 mm Blade
Left



Hovell Lingual

S-25-2161
9", 23 cm
For lower impact wisdom teeth
110 mm Blade
Right

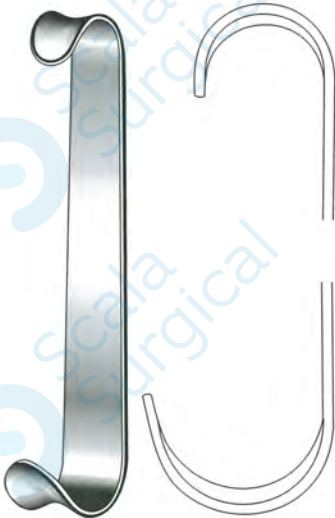

Kilner Cheek

S-25-2162 Small
S-25-2163 Medium
S-25-2164 Large
Double Ended

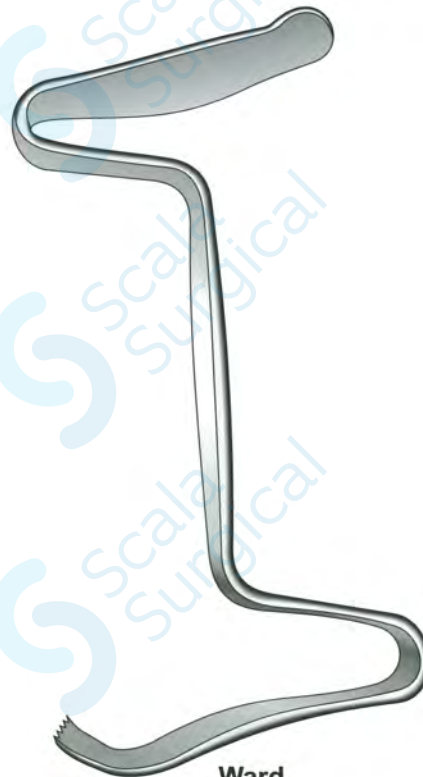

Ward

S-25-2165
Double Ended



Rowe Lingual

S-25-2166 Curved To Left
S-25-2167 Curved To Right
Flap

Retractors



Minnosotta
S-25-2168



Laster
S-25-2169
Cheek Retractor

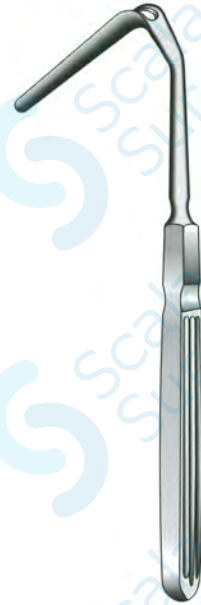

Aufricht
S-25-2170
6 ¼", 16 cm
Nasal Retractor

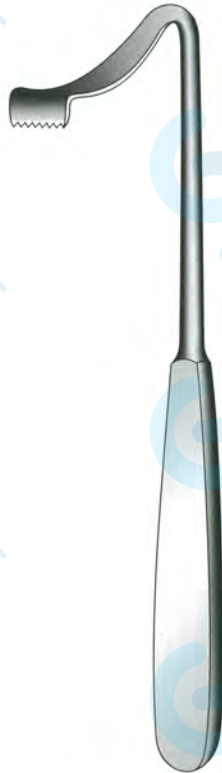

Bowdler Henry
S-25-2171
Rake For Lower Wisdom Teeth



Hajek
S-25-2172
Flat, For Upper Lip

Retractors



Norman Upper
S-25-2173
Right



Norman Upper
S-25-2174
Left



Rowe Buccal
S-25-2175 Curved to Left
S-25-2176 Curved to Right



Rowe Orbital
S-25-2177
Curved to Left
Floor Retractor



Rowe Orbital
S-25-2178
Curved to Right
Floor Retractor



Austin Kay
S-25-2179
6", 15 cm

Retractors



Kilner
S-25-2180 6", 15 cm Sharp
S-25-2181 6", 15 cm Blunt
Senn Muller
S-25-2188 6½", 16 cm

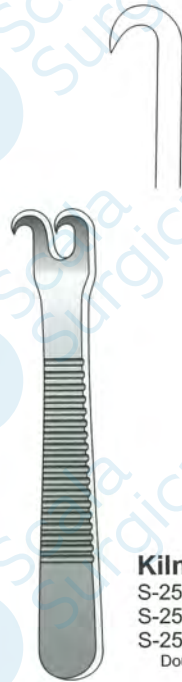

Kilner (Alae)
S-25-2182 8mm
S-25-2183 10mm
S-25-2184 13 mm
Double Prong



Ragnell
S-25-2189
6", 15 cm

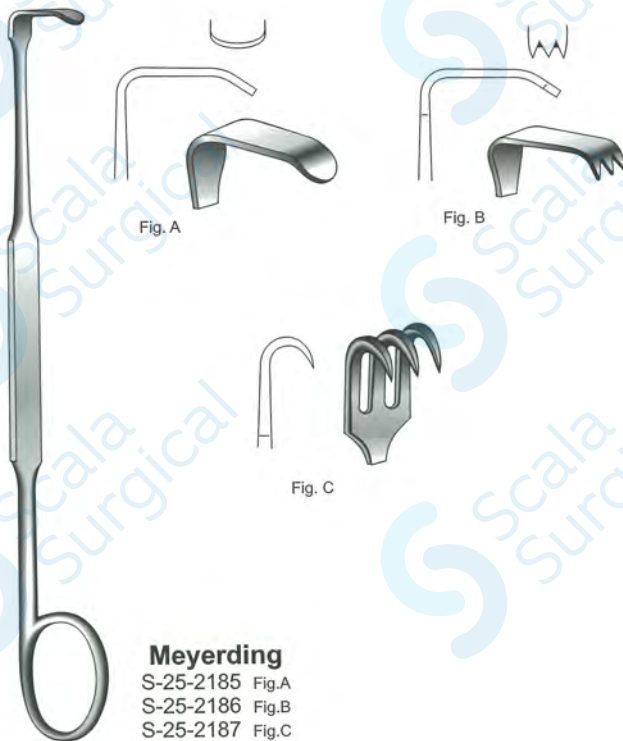

Meyerding
S-25-2185 Fig.A
S-25-2186 Fig.B
S-25-2187 Fig.C



Roux Cheek
S-25-2190
Set Of 3

Retractors



Dixon - Wright
S-25-2191
3½", 9 cm
Skin, Spring Action



Stake
S-25-2192 Small Blade, 13 mm Deep
S-25-2193 Large Blade, 25 mm Deep
For Hand Surgery

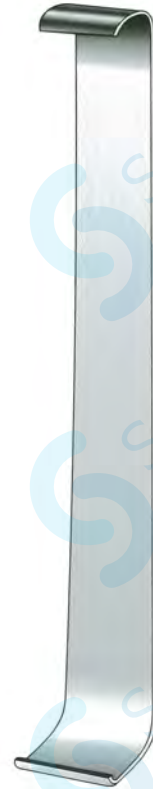

Lane
S-25-2194 6", 15 cm
S-25-2195 9", 23 cm
S-25-2196 11½", 29 cm

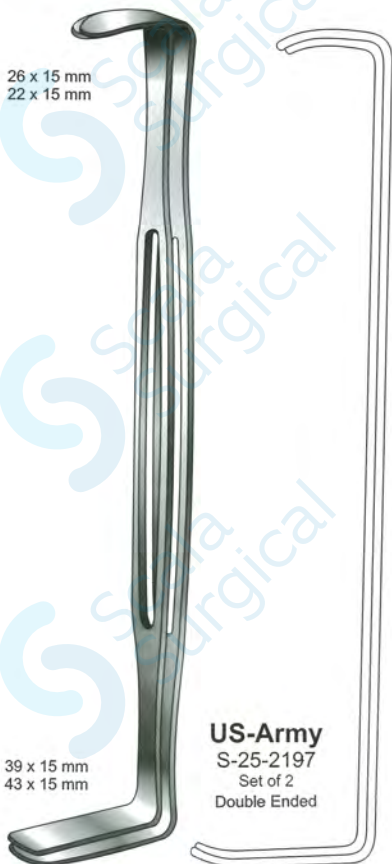

26 x 15 mm
22 x 15 mm

39 x 15 mm
43 x 15 mm

US-Army
S-25-2197
Set of 2
Double Ended



47 x 13 mm
41 x 13 mm

37 x 25 mm
45 x 25 mm

Mathieu
S-25-2198
Set of 2



Moynihan
S-25-2199
8½", 21.5 cm
22 mm deep
Blade 13 mm Wide

Retractors



Volkmann
 S-25-2200 1 prong S-25-2206
 S-25-2201 2 prong S-25-2207
 S-25-2202 3 prong S-25-2208
 S-25-2203 4 prong S-25-2209
 S-25-2204 5 prong S-25-2210
 S-25-2205 6 prong S-25-2211
 Sharp Blunt
 8½", 21.5 cm
 Hollow Handle

Volkmann
 S-25-2212 1 prong S-25-2218
 S-25-2213 2 prong S-25-2219
 S-25-2214 3 prong S-25-2220
 S-25-2215 4 prong S-25-2221
 S-25-2216 5 prong S-25-2222
 S-25-2217 6 prong S-25-2223
 Sharp Blunt
 8½", 21.5 cm
 Kocher Handle



Lempert
 S-25-2225 13mm wide 7½", 19 cm
 S-25-2226 22mm wide 9½", 24 cm

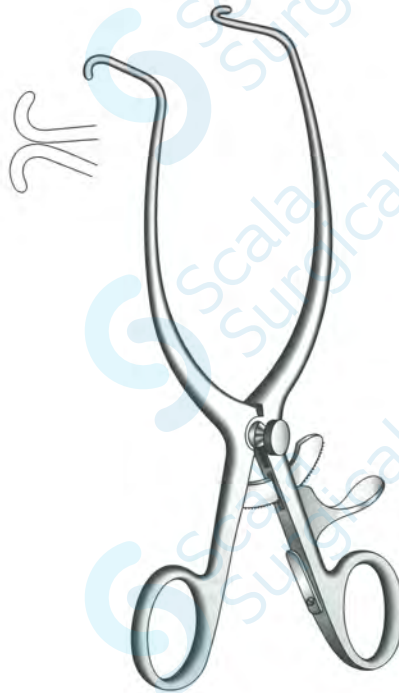

Jackson Burrows
 S-25-2228
 7", 17.8 cm
 2.2 cm deep
 Blunt Hook Jaws



Tudor Edwards
 S-25-2229
 Scapula

Retractors



Langenbeck

- S-25-2231 Small, 22x7mm
- S-25-2232 Medium, 44x13 mm
- S-25-2233 Large, 65x25 mm
- S-25-2234 Extra-Large, 90x20 mm
8½", 21.5 cm



Kocher-Langenbeck

- S-25-2236 Small, 22x7mm
- S-25-2237 Medium, 44x13 mm
- S-25-2238 Large, 65x25 mm
8½", 21.5 cm

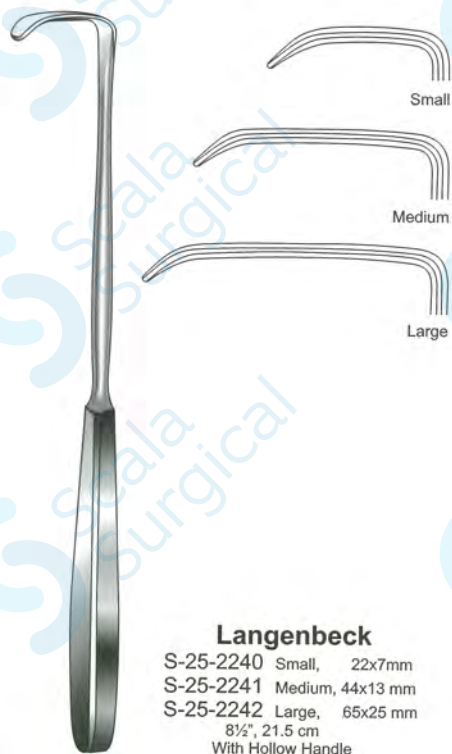
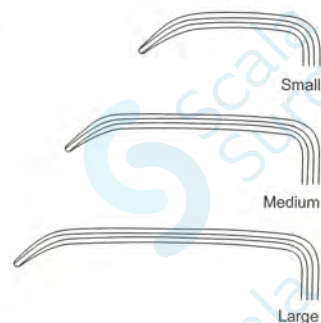

Langenbeck

- S-25-2240 Small, 22x7mm
- S-25-2241 Medium, 44x13 mm
- S-25-2242 Large, 65x25 mm
8½", 21.5 cm
With Hollow Handle

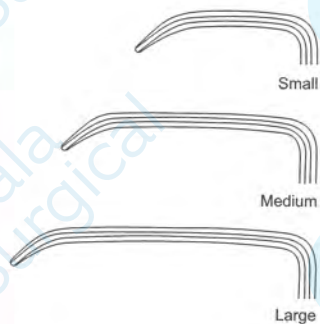

Langenbeck Green



S-25-2244
16 x 6 mm



S-25-2245
24 x 6 mm

Retractors



Barrington
S-25-2250

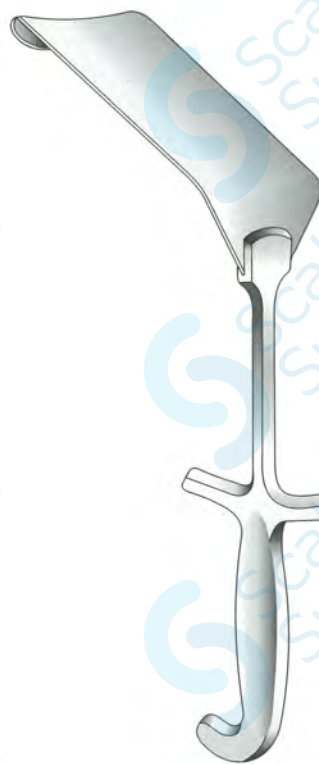

Nuttal
S-25-2253



Worrell
S-25-2255
Abdominal Retractor
Solid forged, Ring Handle,
Blade 100 x 50 mm



Morris
S-25-2260 52x38 mm
S-25-2261 52x52 mm
S-25-2262 52x64 mm
S-25-2263 50x50 mm
S-25-2264 50x60 mm
S-25-2265 25x65 mm
S-25-2266 40x70 mm
S-25-2267 50x70 mm
S-25-2268 65x70 mm
Single Ended



Morris

S-25-2270 52x30, 52x38
 S-25-2271 52x44, 52x55
 S-25-2272 52x57, 52x64
 S-25-2273 45x70, 50x70
 S-25-2274 58x70, 65x70
 Double Ended



Ollier

S-25-2276
 9½", 24 cm
 38 mm deep, 25 mm wide



Richardson

S-25-2278 20 mm wide, 28 mm deep
 S-25-2279 28 mm wide, 36 mm deep
 S-25-2280 38 mm wide, 44 mm deep
 9½", 24 cm

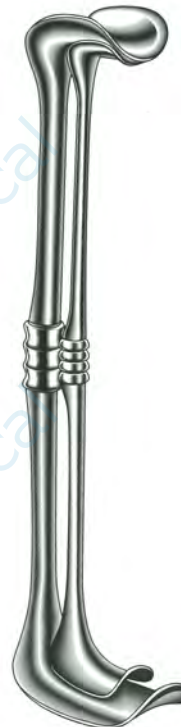

Richardson East

Blades
 S-25-2282 22 x 20 mm
 36 x 28 mm
 S-25-2283 49 x 38 mm
 63 x 49 mm
 Double Ended

Retractors



Deaver

	Blade,	Length
S-25-2290	18 mm wide,	7", 18 cm
S-25-2291	25 mm wide,	9", 23 cm
S-25-2292	25 mm wide,	10", 25.5 cm
S-25-2293	25 mm wide,	12", 30.5 cm
S-25-2294	38 mm wide,	12", 30.5 cm
S-25-2295	50 mm wide,	12", 30.5 cm
S-25-2296	75 mm wide,	12", 30.5 cm
S-25-2297	25 mm wide,	13½", 33.5 cm
S-25-2298	50 mm wide,	13½", 33.5 cm
	Plain Handle	

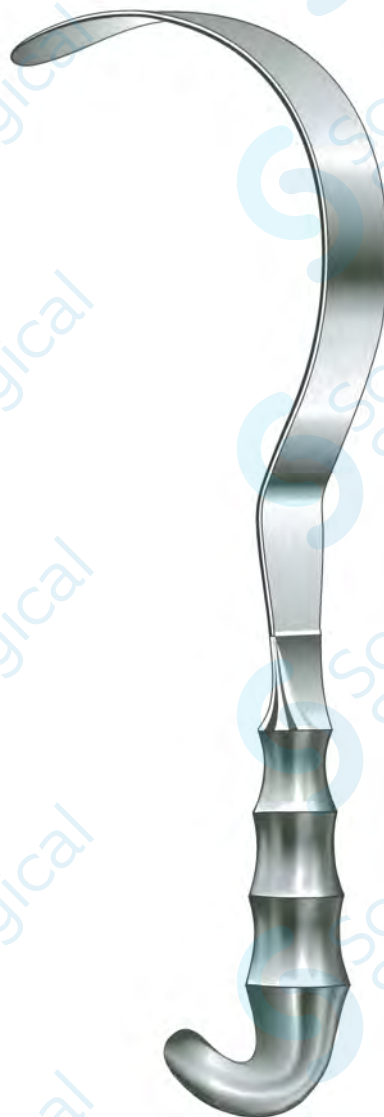

Deaver

	Blade,	Length
S-25-2301	25 mm wide,	9", 23 cm
S-25-2302	25 mm wide,	10", 25.5 cm
S-25-2303	25 mm wide,	12", 30.5 cm
S-25-2304	38 mm wide,	12", 30.5 cm
S-25-2305	50 mm wide,	12", 30.5 cm
S-25-2306	75 mm wide,	12", 30.5 cm
S-25-2307	25 mm wide,	13¼", 33.5 cm
	Hollow Handle	



Doyen

- S-25-2309 Small, 90 mm wide
- S-25-2310 Medium, 100 mm wide
- S-25-2311 Large, 115 mm wide
8½", 21.5 cm
Abdominal

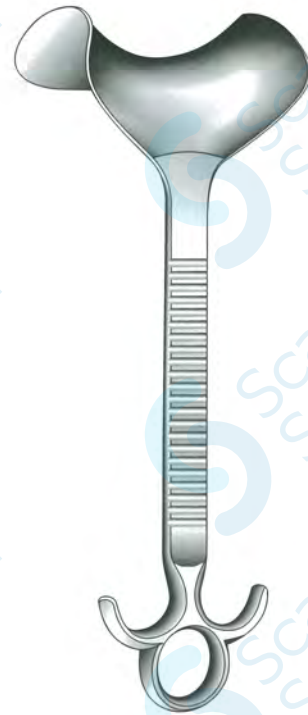

Doyen

- S-25-2313 Small, 95 mm wide
- S-25-2314 Medium, 105 mm wide
- S-25-2315 Large, 115 mm wide
Ring Handle



Dartigue
S-25-2320
65x25 mm



Dyball
S-25-2325
8½", 21.5 cm
4½" deep x 2½" wide

Retractors



Harrington

S-25-2330 End of Blade = 40 mm, Small
S-25-2331 End of Blade = 64 mm, Large
12", 30.5 cm

Kelly

S-25-2332 50x40 mm
S-25-2333 64x54 mm
S-25-2334 70x65 mm
S-25-2335 90x76 mm

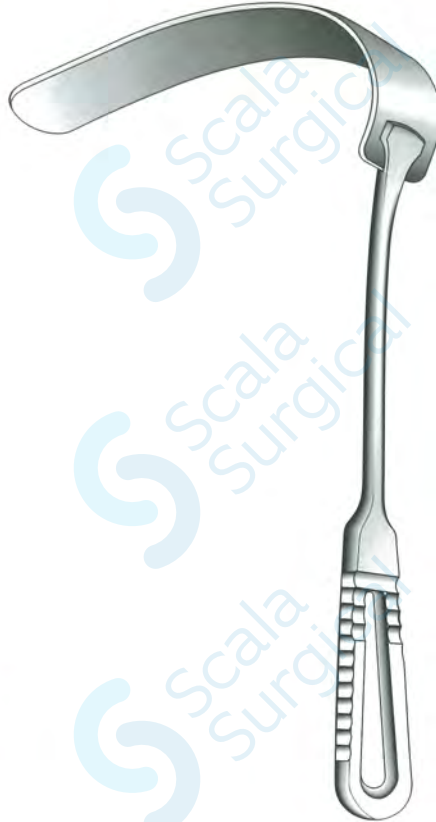

Kelly

S-25-2336 1½", 4 cm Wide
 S-25-2337 2¼", 6 cm Wide
 Blade 7½", 19 cm Deep



Fritsch

S-25-2338 40x45 mm
 S-25-2339 50x45 mm
 S-25-2340 60x45 mm
 S-25-2341 75x45 mm



Pyrah

S-25-2342 Small, 75x50 mm
 S-25-2343 Medium, 100x65 mm
 S-25-2344 Large, 125x55 mm

Retractors



St.Mark / Lloyd Davis

- S-25-2347 Blade 130 x 60 mm with lip
- S-25-2348 Blade 130 x 60 mm without lip
- S-25-2349 Blade 180 x 60 / 45 mm with lip
- S-25-2350 Blade 180 x 60 / 45 mm without lip
- S-25-2351 Blade 130 x 45 / 35 mm with lip
Hollow Handle

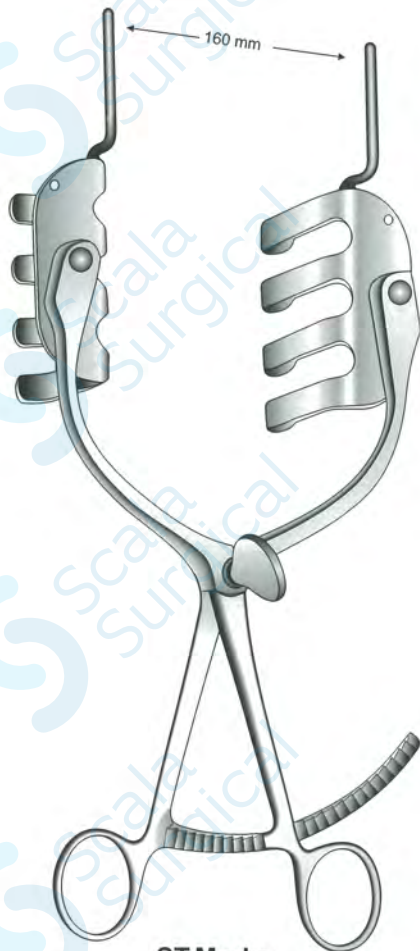

ST.Marks
S-25-2352
8 1/4", 21 cm
Perineal Retractor with Towel Peg
Swivel Rake Blades
40 mm x 70mm Blades



Lace
S-25-2353
Abdominal
With Swivel Blade

Retractors

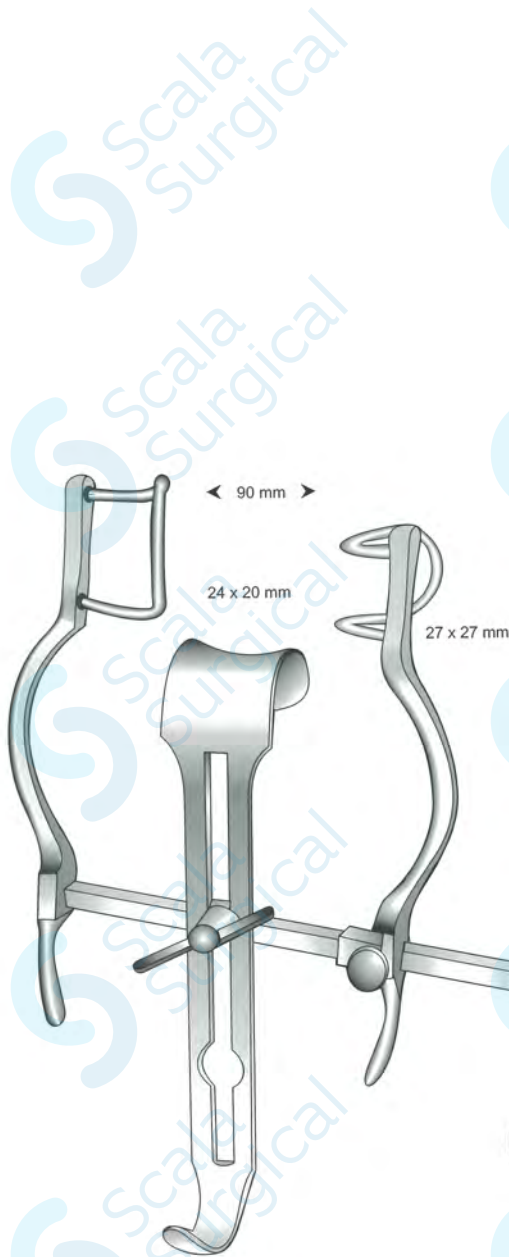

Balfour
S-25-2356
Abdominal, with center Blade
Baby

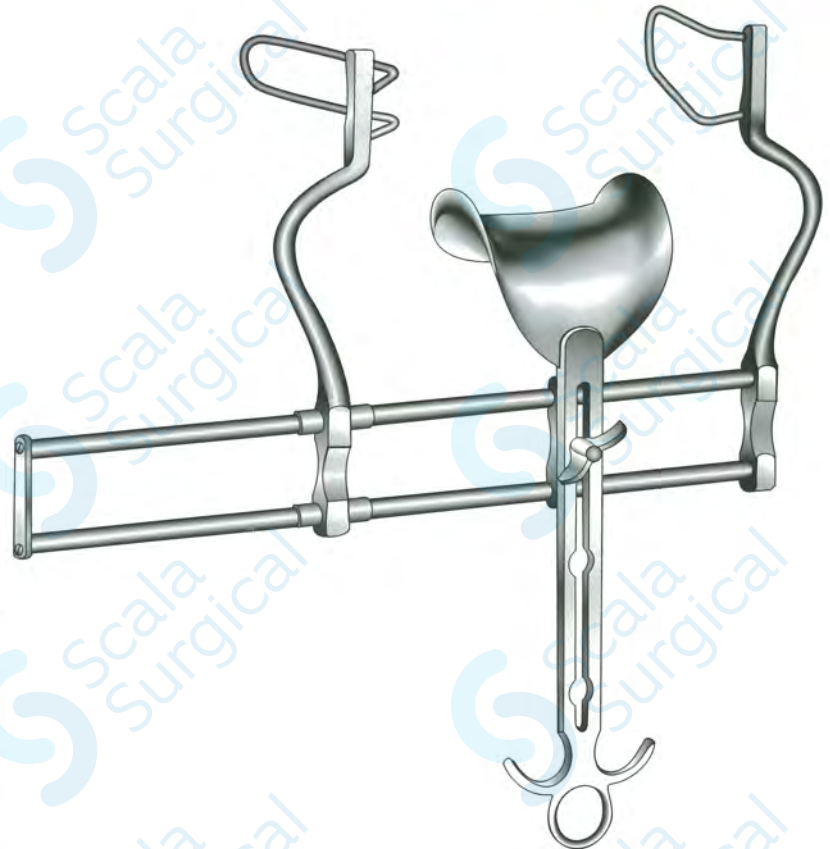

Balfour
S-25-2355
Abdominal, with center Blade
Adult



Central Blade Only
S-25-2358
54 x 80 mm



Central Blade Only
S-25-2359
Deep 62 x 76 mm

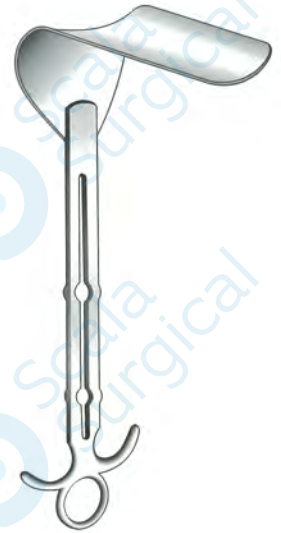

Central Blade Only
S-25-2360
107 x 59 mm

Retractors

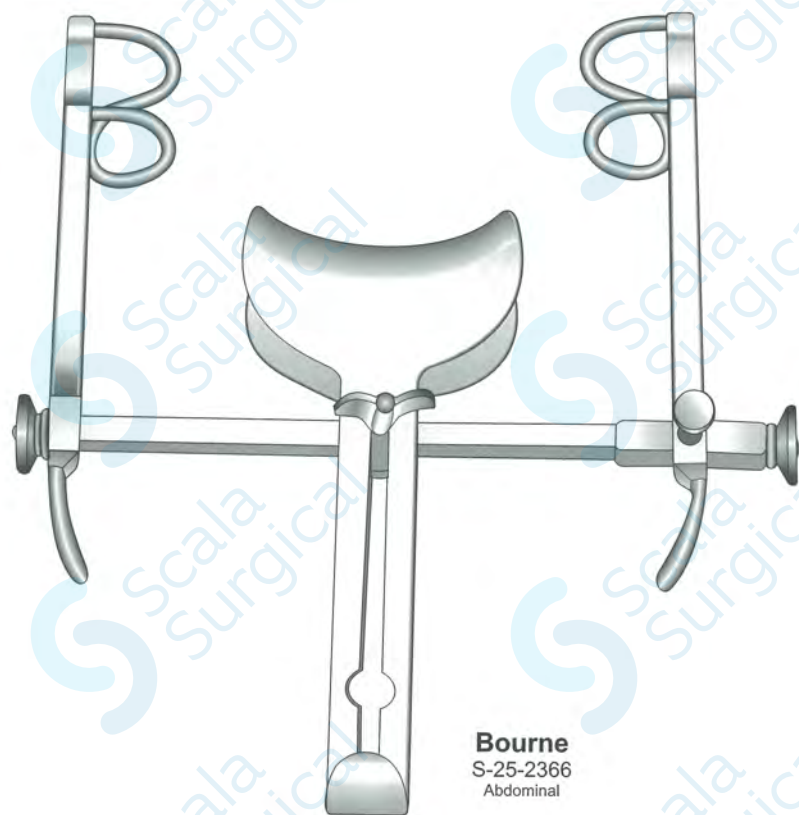

Bourne
S-25-2366
Abdominal



Kocher
S-25-2371 80x42 mm
S-25-2372 80x50 mm
S-25-2373 80x60 mm

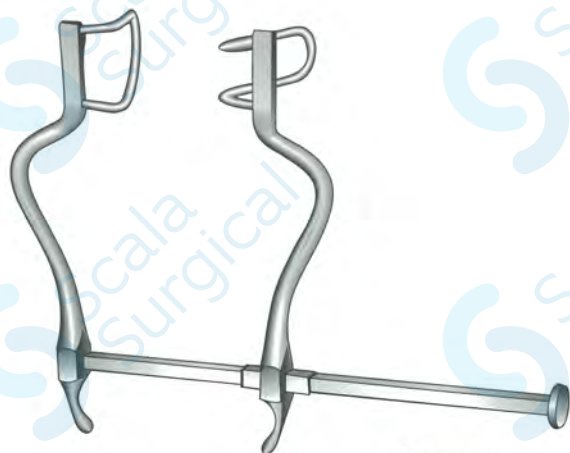

Gossett
S-25-2368 Adult
S-25-2369 Child

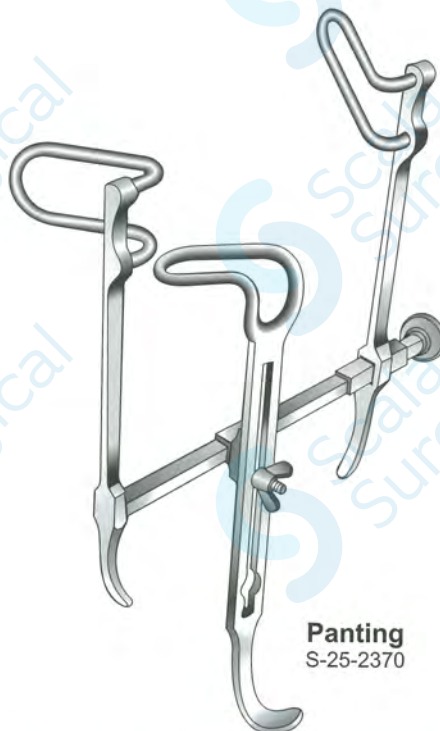

Panting
S-25-2370

Retractors



Collin
S-25-2374 Bi-Valve
S-25-2375 Tri-Valve
Abdominal



Mayo
S-25-2377
With Center Blade
Abdominal



Robin Masse
S-25-2380
Center Blade 64 mm wide, 38 mm deep
Abdominal

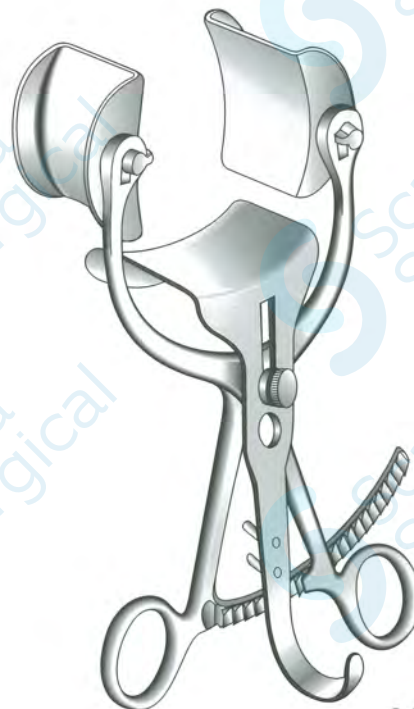

Pozzi
S-25-2382 Bi Valve
S-25-2383 Tri-Valve
Abdominal

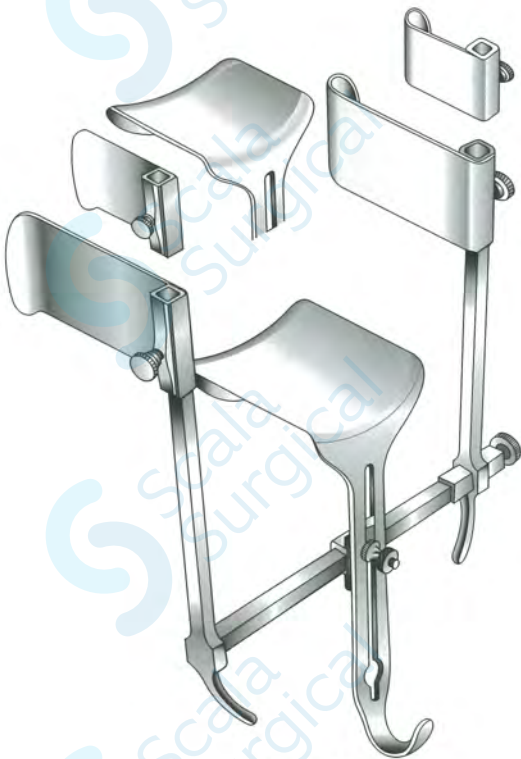

Goligher
S-25-2385
Abdominal Retractor



Naunton Morgan
S-25-2384
Abdominal

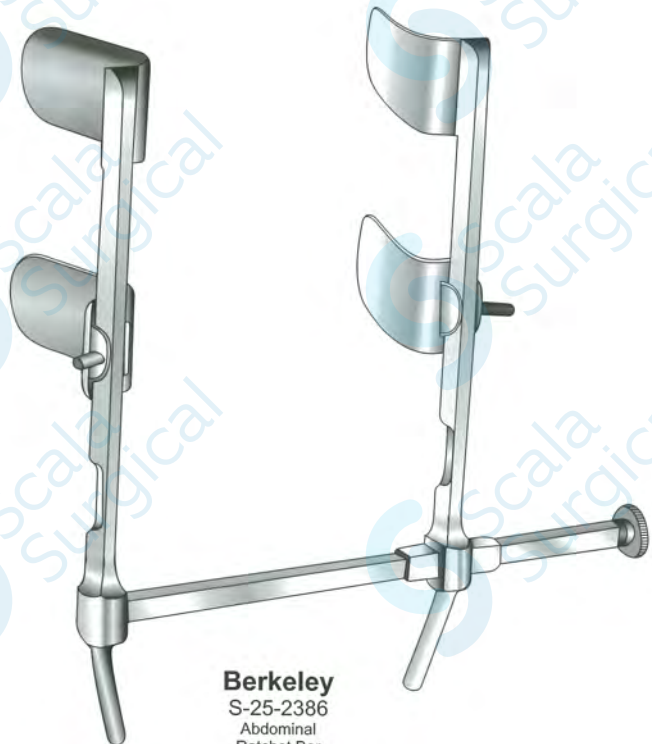

Berkeley
S-25-2386
Abdominal
Ratchet Bar
2 Fixed 60x35 mm Blade &
2 Adjustable 60x35 mm Blade

Retractors

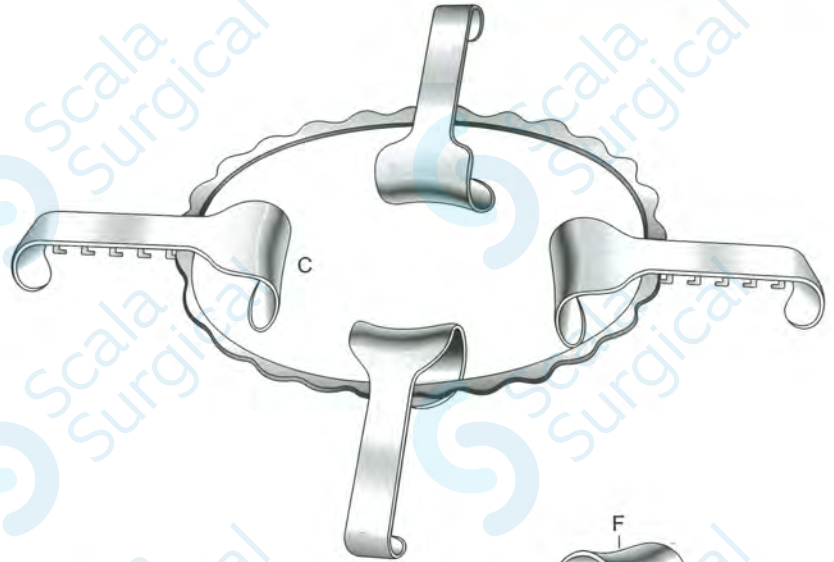
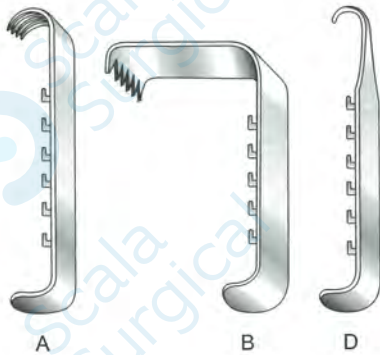

Denis Browne

- S-25-2387 Denis Browne Retractor Set, Comprising:-
- S-25-2388 Sprocket Frame, Oval, 18cm. x 14cm (7" X 5½") Internal Dimension.
- S-25-2389 A. Curved Claw Blade, 1.3 cm x 1.3cm (½" x ½") 4 in set.
- S-25-2390 B. Angled Claw Blade, 6 cm x 2 cm, (2¼". x ¾") 4 in set.
- S-25-2391 C. Curved Blade, 4 cm x 3.5 cm. (1½" x ") 4 in set.
- S-25-2392 D. Curved Hook Blade Sharp. 2 in set.
- S-25-2393 E. Lung Retracting End to fit Shaft H. Malleable wire.
- S-25-2394 F. Curved Blade End, to fit shaft H, 4cm. x 3.5cm (1½" x ")
- S-25-2395 G. Blade End, as above but with regressive curve.
- S-25-2396 H. Shaft for ends E, F, & G, with threaded retracting action.
- S-25-2396-A J. Spanner to fit shaft H.

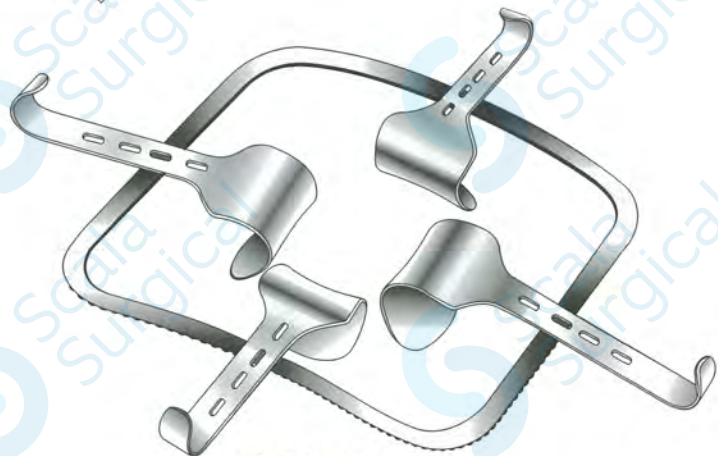
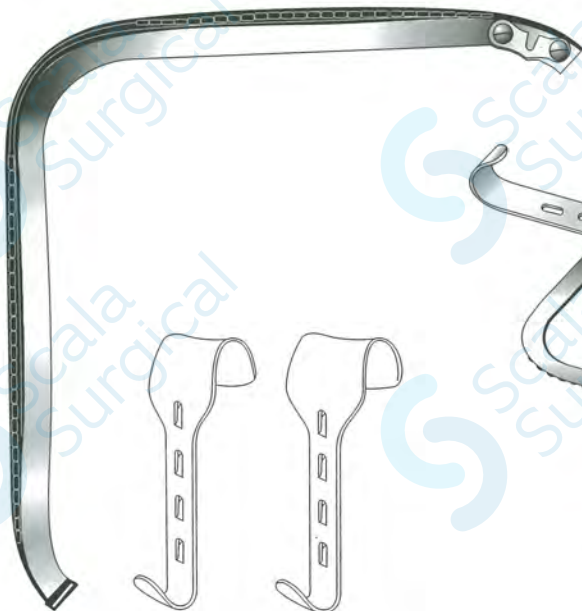
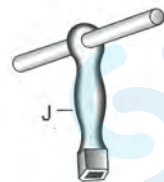
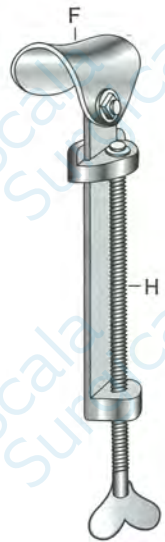
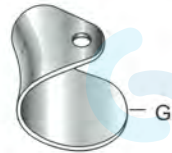
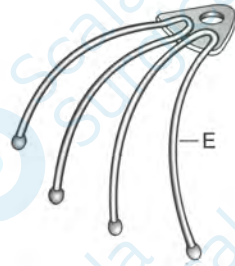

Kirschner

- S-25-2397 Fixed Frame
- S-25-2398 Folding Frame
- S-25-2399 Blades Only Abdominal

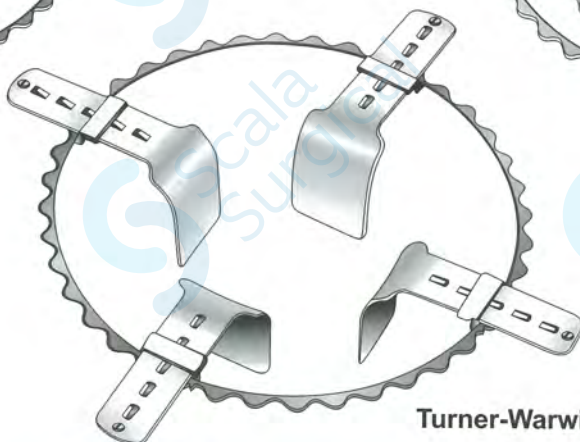
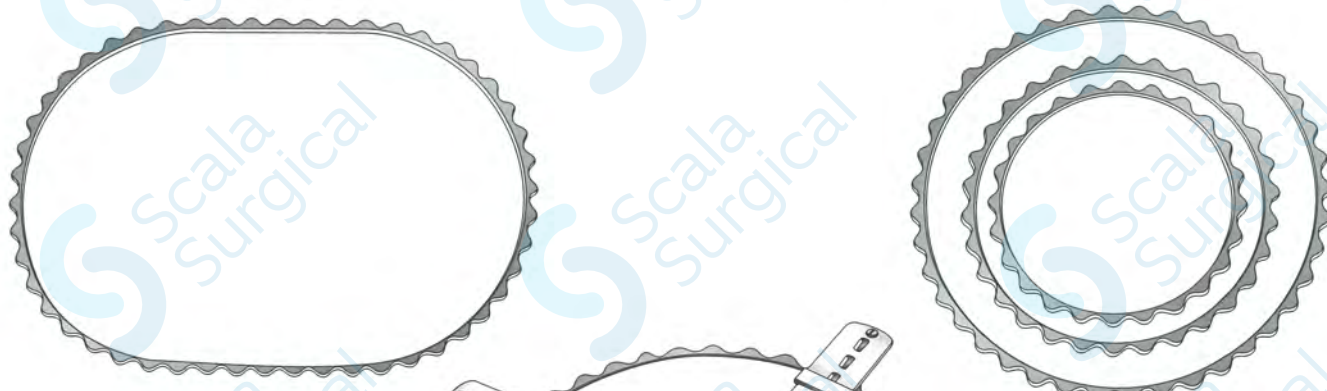
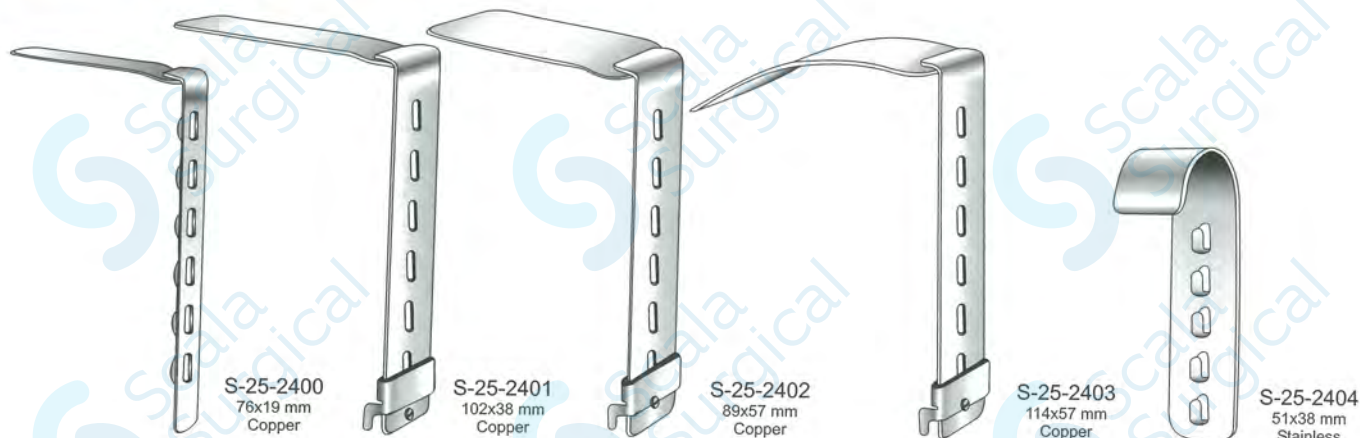

Retractors

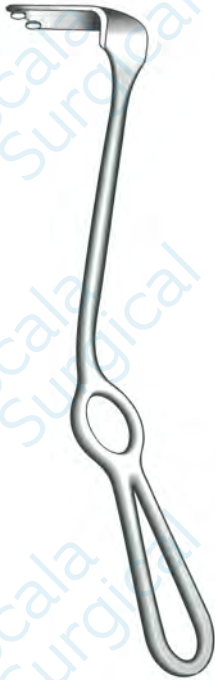

Joll
S-25-2420
Thyroid (Hand Held)



Joll
S-25-2422
Thyroid (With Locking Nut)

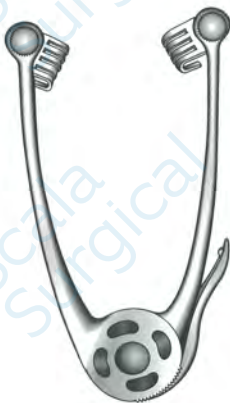

Kocher
S-25-2424
Thyroid



Kocher
S-25-2426 10x20 mm
S-25-2427 15x20 mm
S-25-2428 20x30 mm
Thyroid

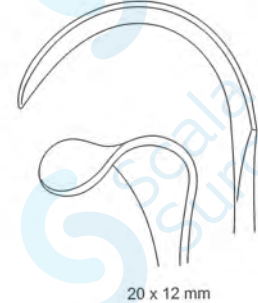

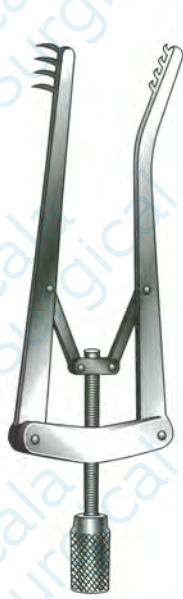

Alm
S-25-2430 2 3/4", 7 cm
S-25-2431 4", 10 cm
Sharp

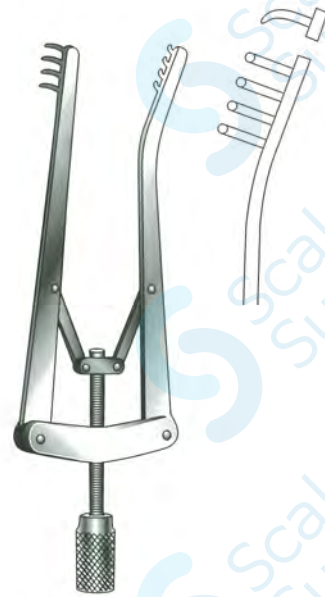

Alm
S-25-2433 2 3/4", 7 cm
S-25-2434 4", 10 cm
Blunt

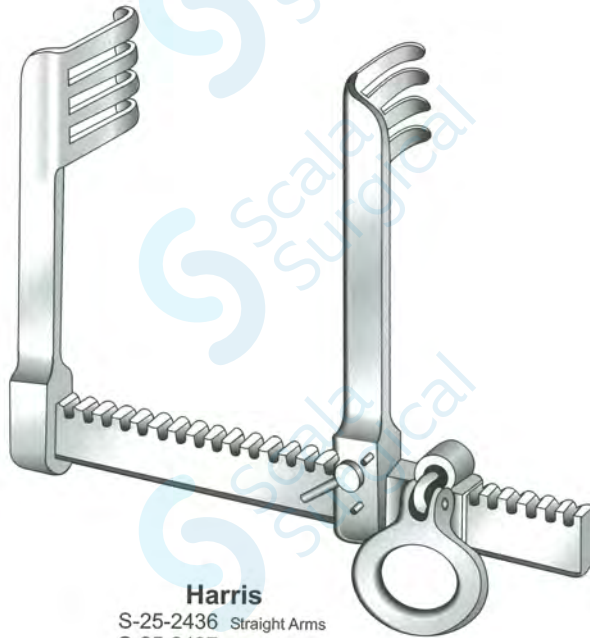

Harris
S-25-2436 Straight Arms
S-25-2437 Angled Arms
4 x 4 Prongs
Laminectomy

Retractors

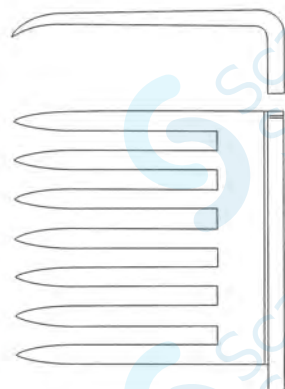

Beckmann Eaton
S-25-2438
13", 33 cm
7x7 Sharp Prongs



Beckmann
S-25-2439
12½", 31.5 cm
4x4 Sharp Prongs

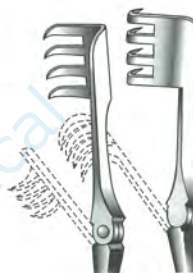
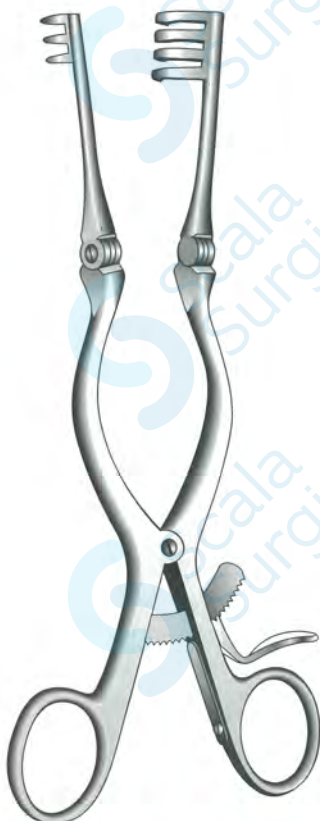

Cone
S-25-2440 5½", 14 cm S-25-2441
S-25-2442 8", 20 cm S-25-2443
S-25-2444 10", 25.5 cm S-25-2445
Sharp Blunt
Laminectomy
3 x 4 Teeth

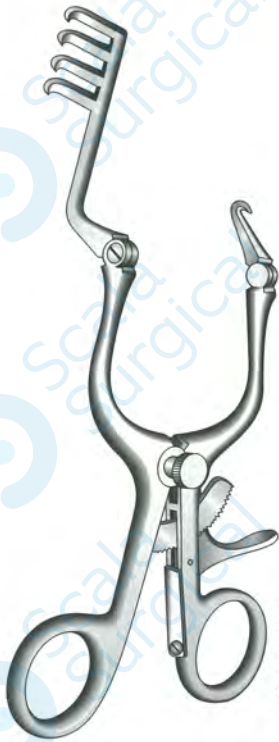

Cone

S-25-2449 Hook, Left Arm 14 cm
 S-25-2450 Hook, Right Arm 14 cm
 6½", 16.5 cm
 S-25-2451 Hook, Left Arm 25 cm
 S-25-2452 Hook, Right Arm 25 cm
 10", 25.5 cm
 Hemi Laminectomy

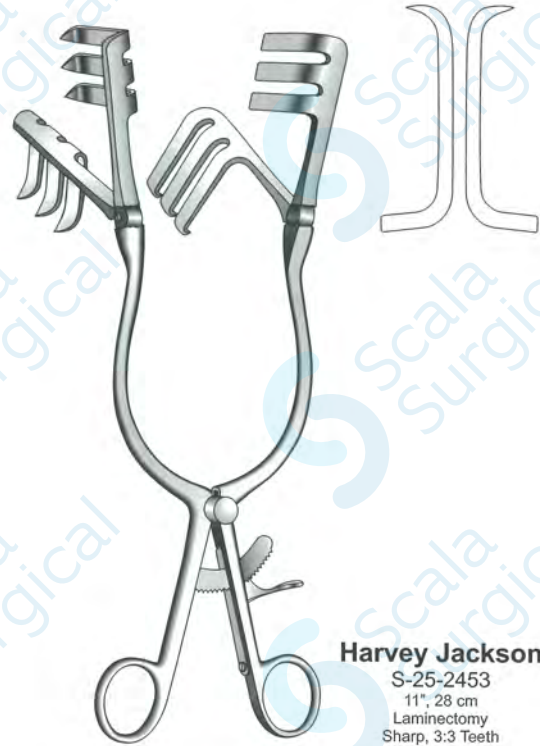

Harvey Jackson

S-25-2453
 11", 28 cm
 Laminectomy
 Sharp, 3:3 Teeth

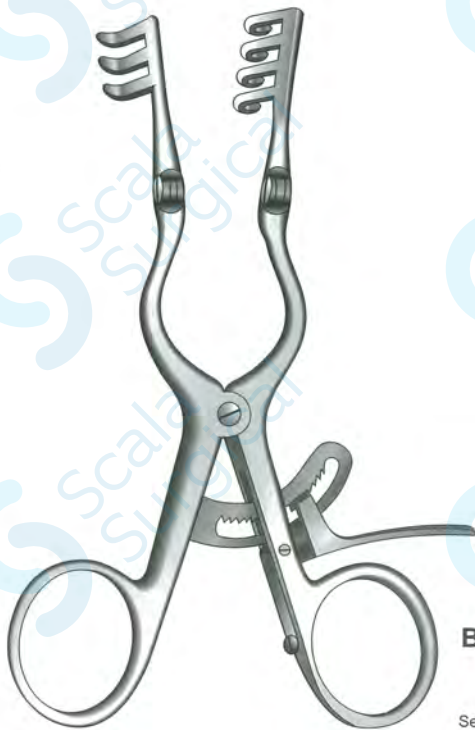

Baby Adson

S-25-2455
 5½", 14cm
 Laminectomy
 Semi Sharp, 3:4 Teeth

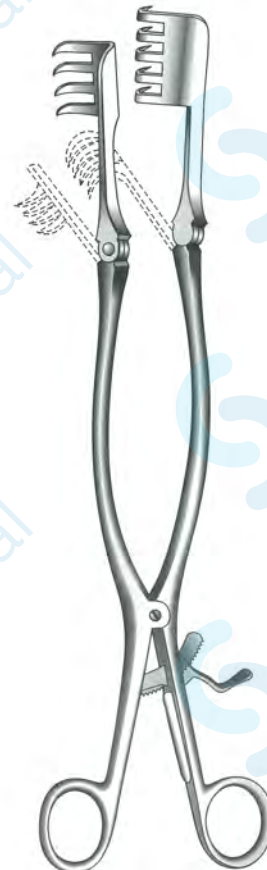

Adson

S-25-2456
 12½", 31.5 cm
 Laminectomy
 4:5 Blunt Teeth

Retractors

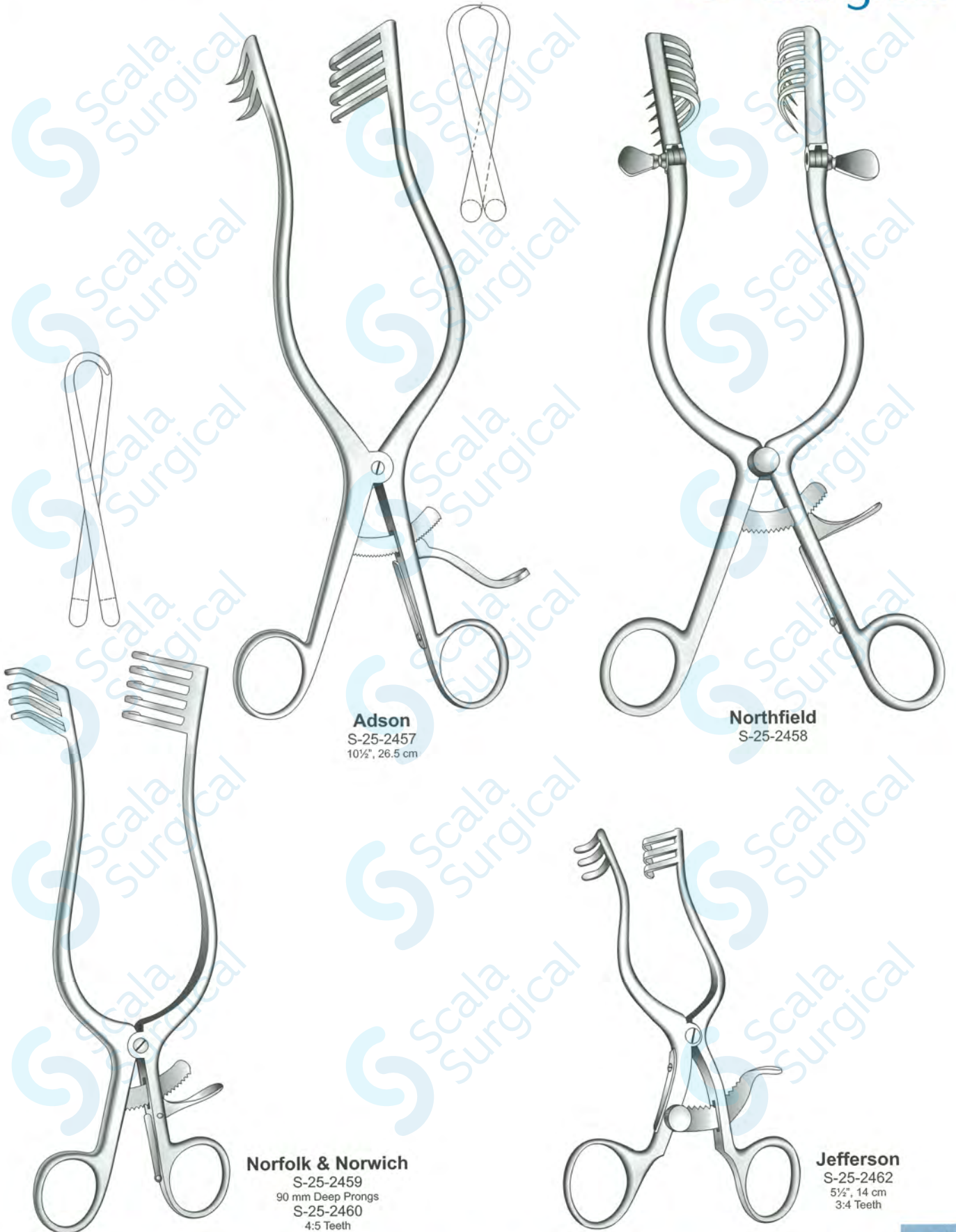

Adson
S-25-2457
10½", 26.5 cm

Northfield
S-25-2458

Norfolk & Norwich
S-25-2459
90 mm Deep Prongs
S-25-2460
4:5 Teeth

Jefferson
S-25-2462
5½", 14 cm
3:4 Teeth

Retractors

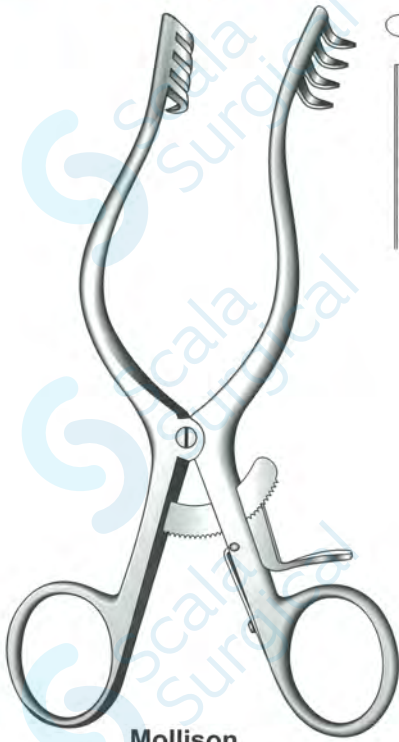

Mollison

S-25-2463 7", 18 cm, Adult, 4:4 Teeth
S-25-2464 5¼", 13.5 cm, Child, 2:2 Teeth

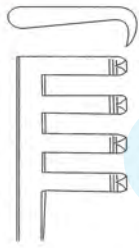

Cawthorne

S-25-2465
6", 15 cm

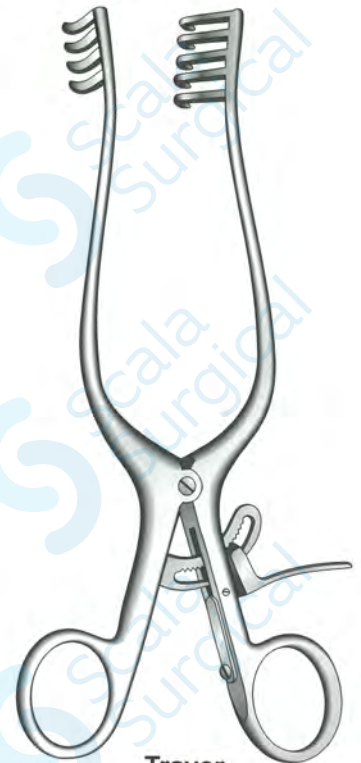

Traver

S-25-2466
8", 20 cm
4:5 Teeth

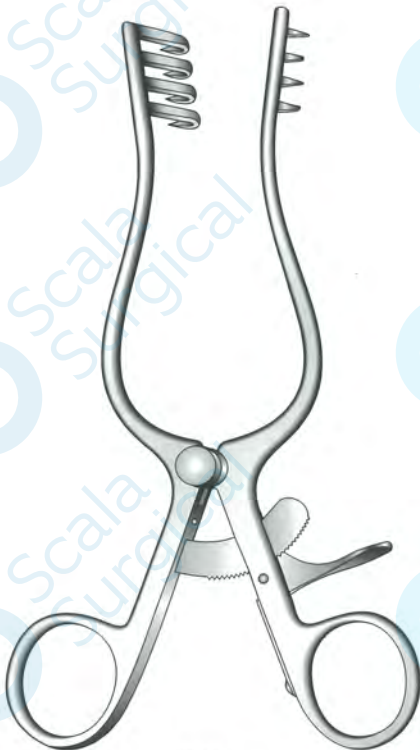

Irwin

S-25-2468
7", 18 cm
4:4 Teeth



West (Weitlaner)

S-25-2470	Sharp	S-25-2471
S-25-2472	Blunt	S-25-2473
4½", 11.5 cm		5½", 14 cm
2:3 Teeth		3:4 Teeth

Retractors



Wieslander

- S-25-2474 2:3 Teeth, Sharp, 4½", 11.5 cm
- S-25-2475 3:4 Teeth, Sharp, 5½", 14 cm
- S-25-2476 2:3 Teeth, Blunt, 4½", 11.5 cm
- S-25-2477 3:4 Teeth, Blunt, 5½", 14 cm
- S-25-2478 3:4 Teeth, Sharp, 6¼", 16 cm
- S-25-2479 3:4 Teeth, Blunt, 6¼", 16 cm

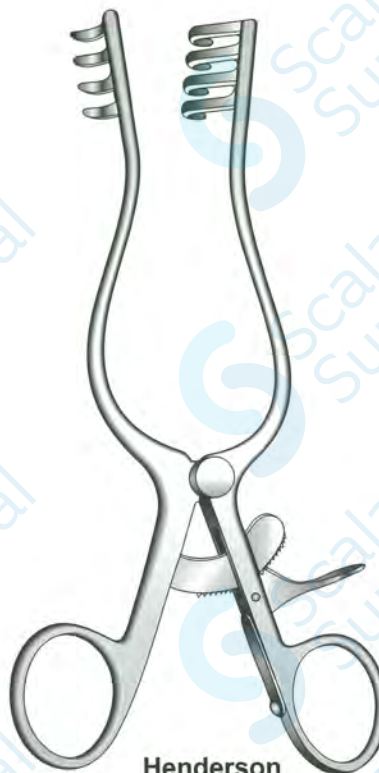

Henderson

- S-25-2480 7", 18 cm
- 4:4 Teeth, Blunt



Jansen

- S-25-2481 Sharp
- S-25-2482 Blunt
- 3:3 Teeth

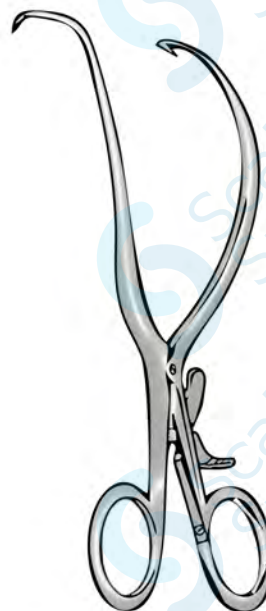
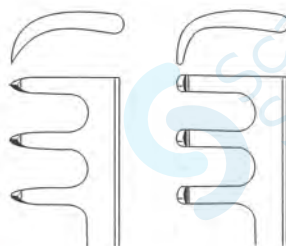

Gelpi Vulva Retractors

- S-25-2483 Small
- S-25-2484 Large



Doyen

S-25-2490 Small, 4.75 x 6cm
 S-25-2491 Medium, 4.75 x 9cm
 S-25-2492 Large, 4.75 x 12.5cm
 Rectangular Blade



Doyen Narrow

S-25-2493



Landon
 S-25-2494

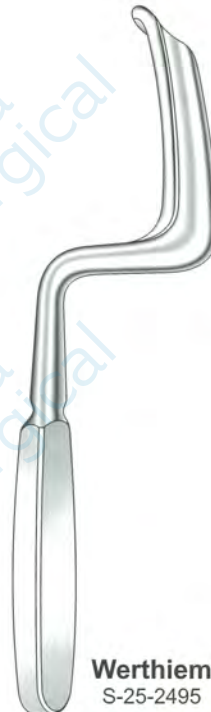

Werthiem
 S-25-2495

Retractors



Blair Bell
S-25-2496



Comyn Berkley
S-25-2497



Rigby
S-25-2498

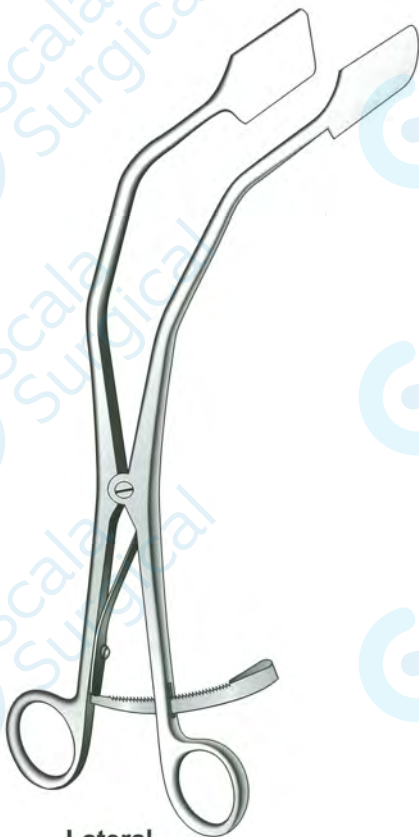

Lateral
S-25-2499



Walton
S-25-2510 ½" Wide
S-25-2511 1" Wide
S-25-2512 1½" Wide
S-25-2513 2" Wide
S-25-2514 2½" Wide
12", 30.5 cm
Malleable, Copper

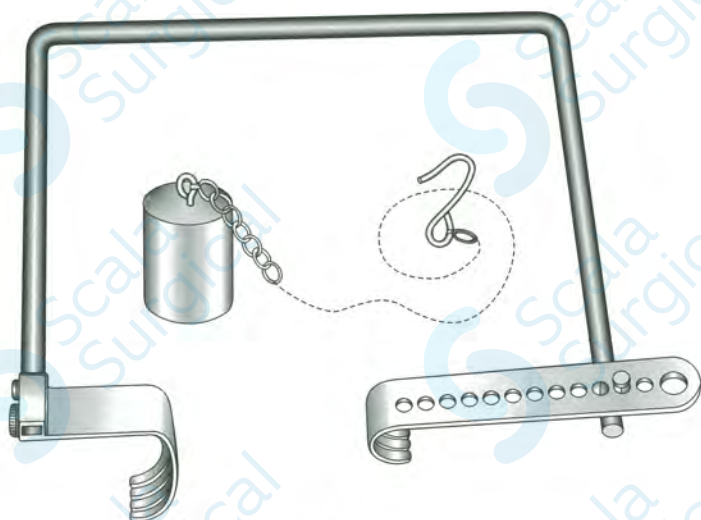

Charnley
S-25-2520 Complete Set
consisting of:
S-25-2521 Large Blade
S-25-2522 Small Blade
S-25-2523 Chain & Weight
Charnley Initial Incision Retractor
12", 30.8 cm

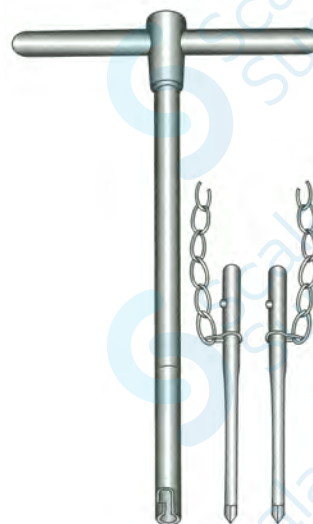

Charnley
S-25-2524
Pin Retractor



Charnley Retractor
S-25-2526
12 1/4", 31.2 cm
Horizontal



Charnley Retractor
S-25-2527
12 1/4", 31.2 cm
Vertical

Retractors

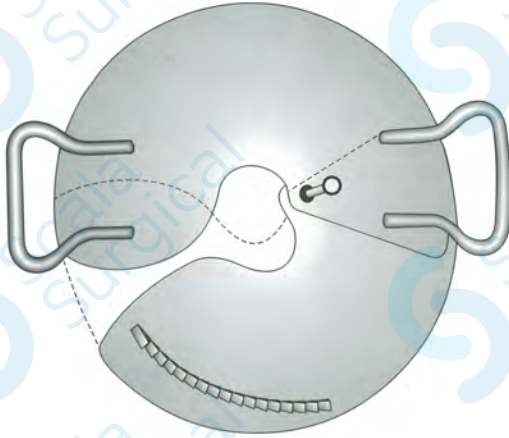

Blakes
S-25-2528
Amputation



Percy
S-25-2529
Amputation

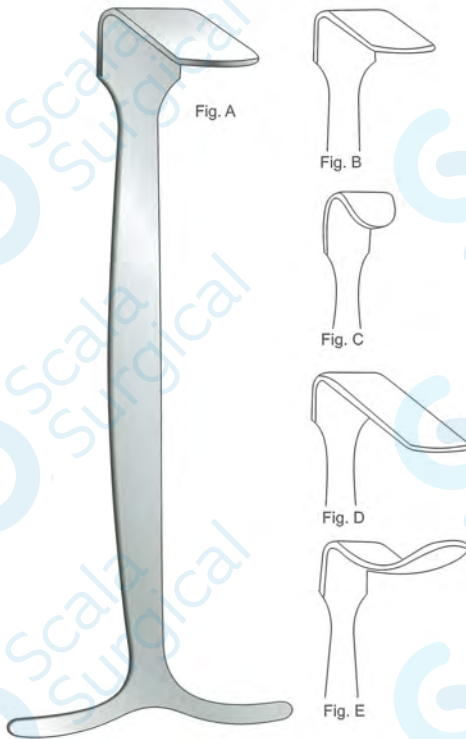

Smillie

- S-25-2530 Fig. A, Hook 145 mm, Set of 2
- S-25-2531 Fig. B, Angled 32x19 mm
- S-25-2532 Fig. C, Hook 41x19 mm
- S-25-2533 Fig. D, Hook 57x19 mm
- S-25-2534 Fig. E, Right Angled Curved
5 1/4", 14.5 cm
Blade 10mm wide

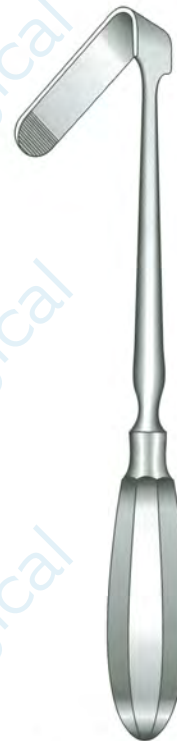

Jackson Burrows

- S-25-2540
Knee
Angled Blade
20 mm wide

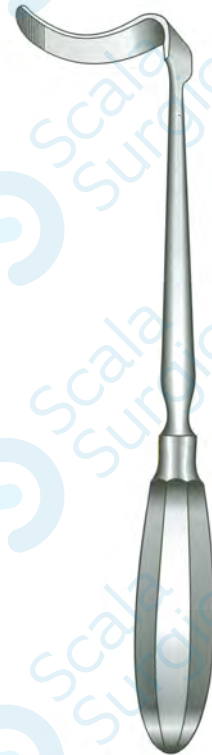

Jackson Burrows

- S-25-2541
Knee
Curved Blade
13 mm wide

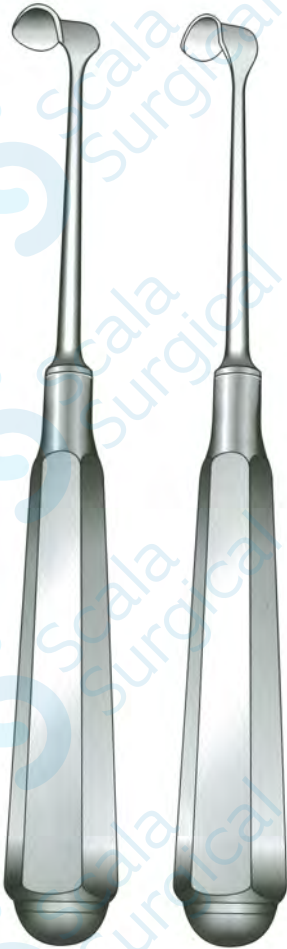

Brock Arterial

- S-25-2550 Blade ¼", 5 mm wide
- S-25-2551 Blade ¾", 10 mm wide
- S-25-2552 Blade ½", 12 mm wide Retractors



Clelands

- S-25-2555
- 10", 25.5 cm Long
- Valve Leaflet Retractors

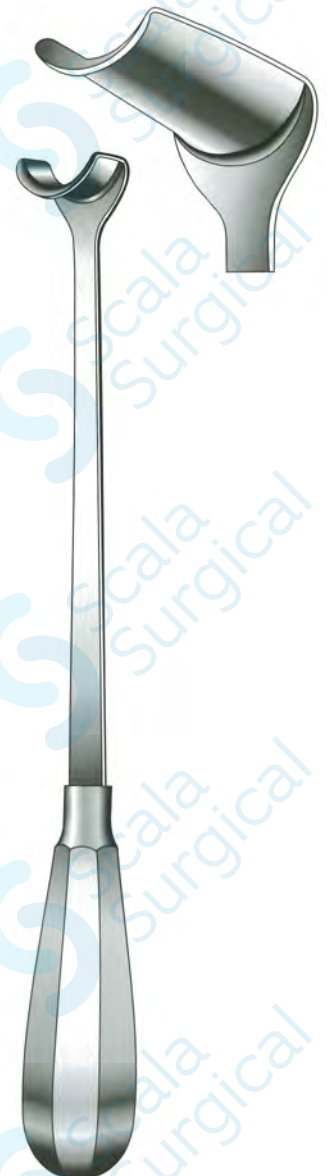

Ross Aortic

Retractors

- S-25-2556 Blade 16 x 15 mm
- S-25-2557 Blade 23 x 13 mm
- S-25-2558 Blade 24 x 16 mm
- S-25-2559 Blade 27 x 13 mm
- S-25-2560 Blade 27 x 27 mm
- S-25-2561 Blade 25 x 39 mm
- 9", 23 cm Long

Retractors

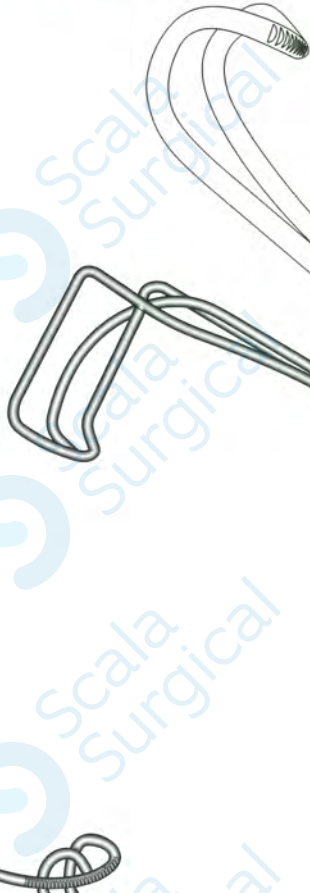

Cooley
S-25-2565
45 mm wide, 45 mm deep
Arterial Retractor

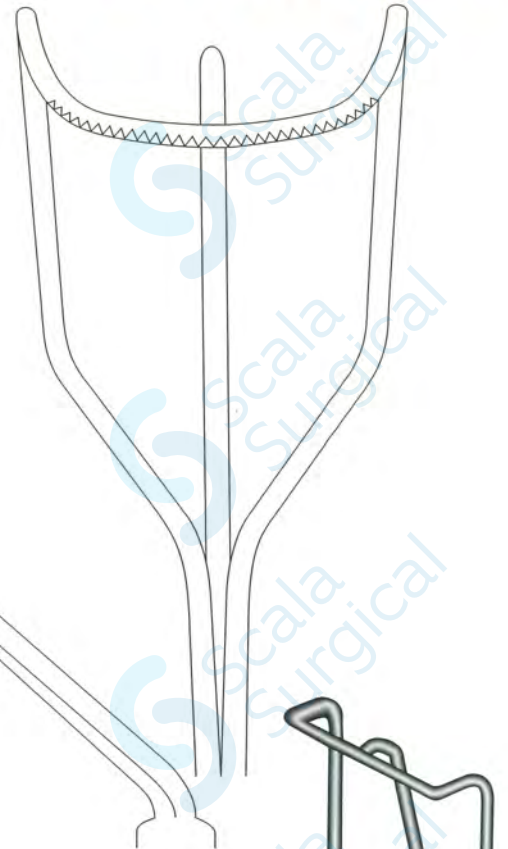

Ross
Modification of Cooleys
S-25-2569
Blade 45 mm wide, 45 mm deep
Arterial Retractor, Right



Cooley
S-25-2567
Blade 45 mm wide, 18 mm deep
Arterial Retractor, Left



Brompton Hospital Pattern
S-25-2572
Erector Spinae (Back End)



Brocks
S-25-2574
Erector Spinae (Back End)



Sembs
S-25-2576
Erector Spinae (Small)

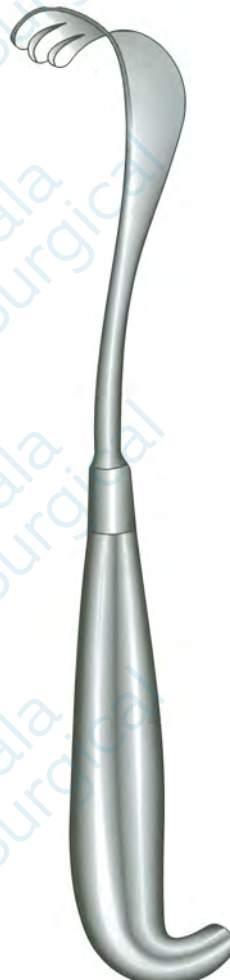

Sembs
S-25-2578
Erector Spinae (Large)

Skin Hook



Gillies

- S-26-2500 Fine Small
- S-26-2501 Fine Medium
- S-26-2502 Fine Large
6½", 16.5 cm



Kilner

- S-26-2503
6½", 16.5 cm
Detachable Handle

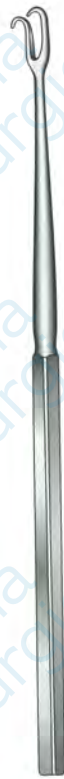

McIndoe (Joseph)

- S-26-2505 9 mm
- S-26-2506 10 mm
- S-26-2507 11 mm
6½", 16.5 cm
Double Hook



McIndoe

- S-26-2508 9 mm
- S-26-2509 10 mm
- S-26-2510 11 mm
6½", 16.5 cm
Double Hook

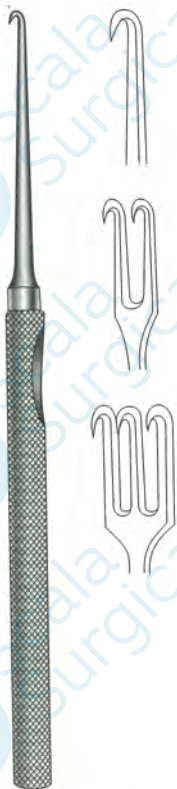

Mannerfelt

- S-26-2512 Single Hook
- S-26-2513 Double Hook
- S-26-2514 Triple Hook
5½", 14 cm



Guthrie

- S-26-2515 3 mm
- S-26-2516 4 mm
Double Hook
5½", 14 cm



Fomon

- S-26-2519 Double Hook, Sharp
- S-26-2520 Double Hook, Blunt
- S-26-2522 Double Hook, Left Sharp, Right Blunt
- S-26-2524 Double Hook, Right Sharp, Left Blunt
5¼", 14.5 cm



Tongue Forceps



Carmalt
S-27-2500
6", 15 cm
Screw Joint

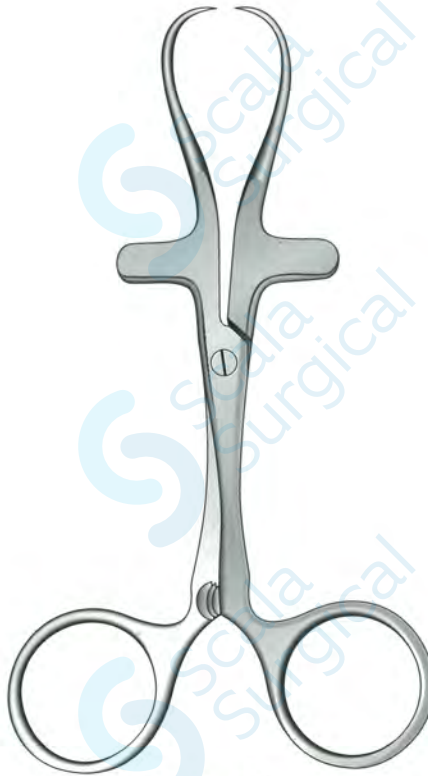

Carbould
S-27-2501 With Wings
S-27-2502 Without Wings
5½", 14 cm
Screw Joint



Collin
S-27-2506 Child, 5½", 14 cm
S-27-2507 Adult, 7", 18 cm
Screw Joint

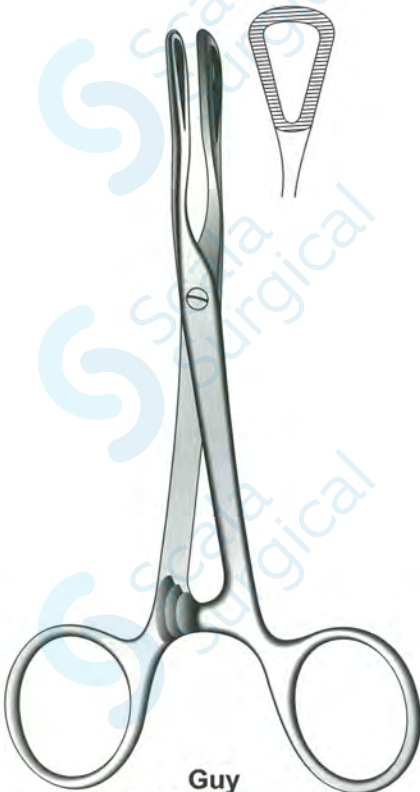

Guy
S-27-2509 Child, 5½", 14cm
S-27-2510 Adult, 7½", 19cm
Screw Joint

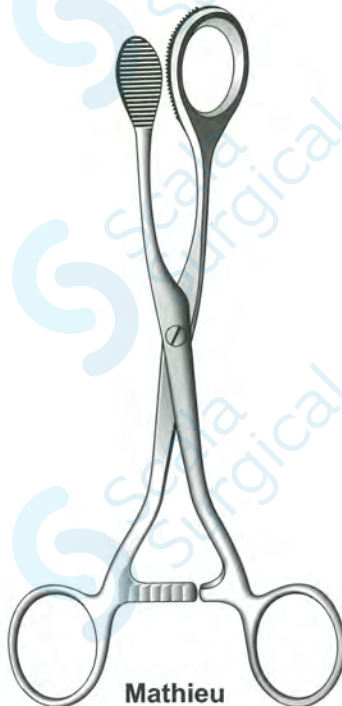

Mathieu
S-27-2512
7½", 19 cm
Screw Joint

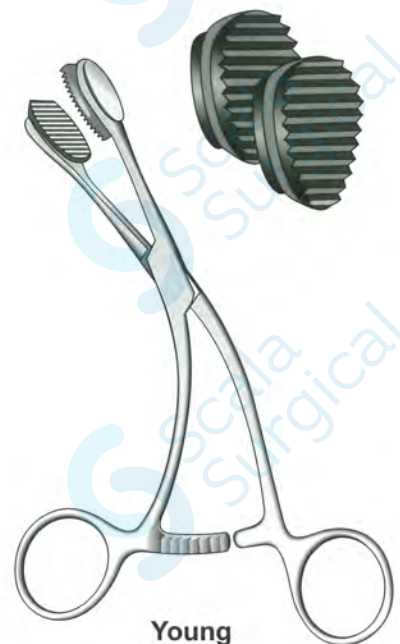

Young
S-27-2515
6¼" 16 cm
Box Joint, Rubber Jaws

Tongue Depressors



Bosworth
S-28-2500
Hollow Handle



Bruenings
S-28-2501
Fenestrated



Lack
S-28-2503 Infant, Size 12 mm
S-28-2504 Child, Size 19 mm
S-28-2505 Adult, Size 22 mm



Mayo
S-28-2507 Child Size
S-28-2508 Adult Size
Tapering



Tobold
S-28-2511
Folding



Tobold
S-28-2512
Hollow Handle



Wieder
S-28-2514 Small
S-28-2515 Large

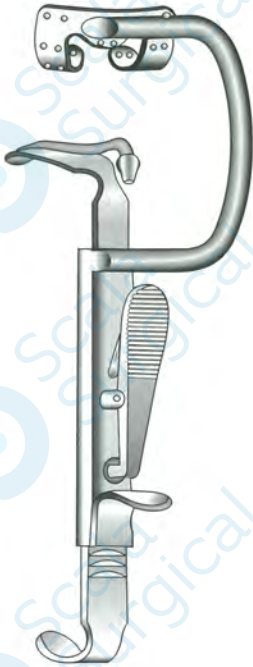

Davis Boyle
S-29-2500 Child Frame
S-29-2501 Adult Frame



S-29-2505 Tongue Plate 65 mm
S-29-2506 Tongue Plate 75 mm
S-29-2507 Tongue Plate 90 mm
S-29-2508 Tongue Plate 100 mm
S-29-2509 Tongue Plate 115 mm
With Anesthesia Tubes

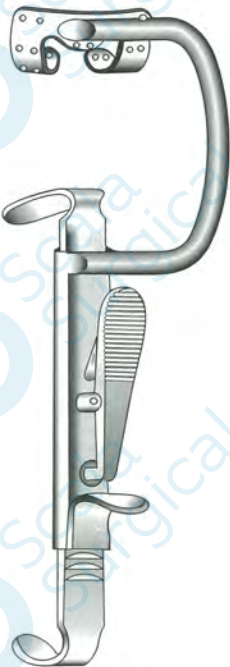

Davis Boyle
S-29-2515
Complete with Frame &
5 Tongue Plates



S-29-2510 Tongue Plate 65 mm
S-29-2511 Tongue Plate 75 mm
S-29-2512 Tongue Plate 90 mm
S-29-2513 Tongue Plate 100 mm
S-29-2514 Tongue Plate 115 mm

Mouth Gags



Daughty

- S-29-2516 Tongue Plate 65 mm
- S-29-2517 Tongue Plate 75 mm
- S-29-2518 Tongue Plate 90 mm
- S-29-2519 Tongue Plate 100 mm
- S-29-2520 Tongue Plate 115 mm

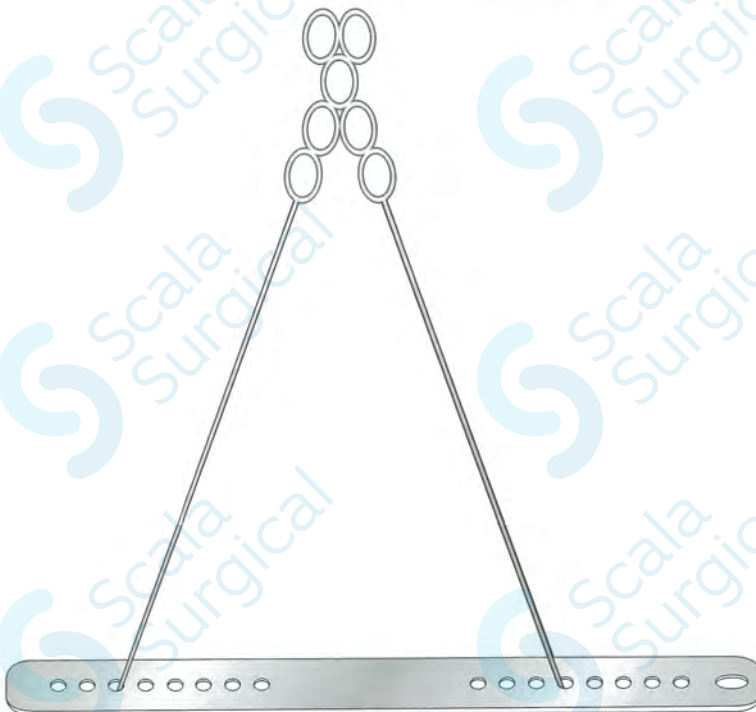

Draffin Bipod

- S-29-2525 Child Size
 - S-29-2526 Adult Size
- Magauran Plate**
For Holding Draffin Bipod
S-29-2528



Doyen

- S-29-2531 Adult
- S-29-2532 Child



Featherstone
S-29-2535

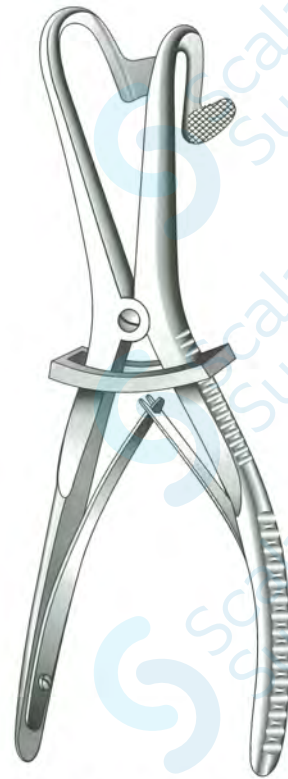

Fergusson
S-29-2537 Ackland Jaws S-29-2538
S-29-2539 Parallel Jaws S-29-2540
Adult, 8", 20 cm Child, 6 1/4", 16 cm

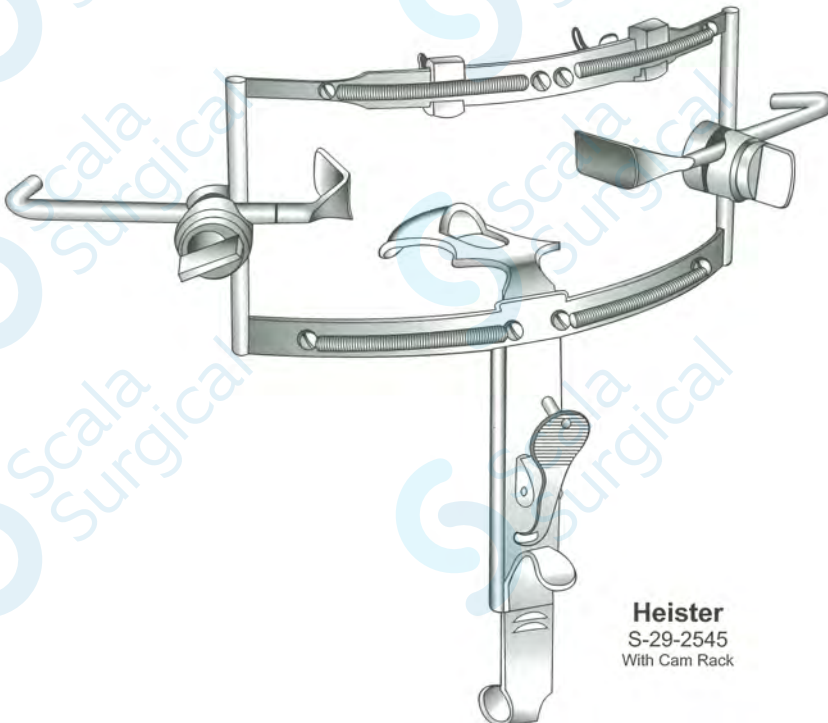

Heister
S-29-2545
With Cam Rack

Mouth Gags

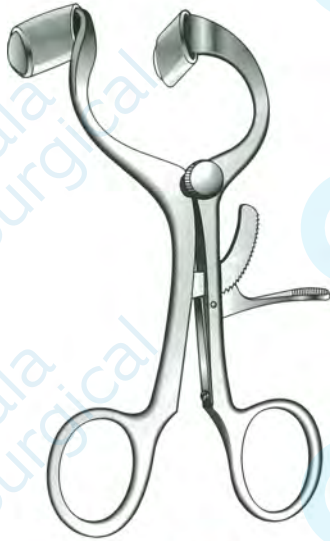

Molt

S-29-2546 Adult
S-29-2547 Child

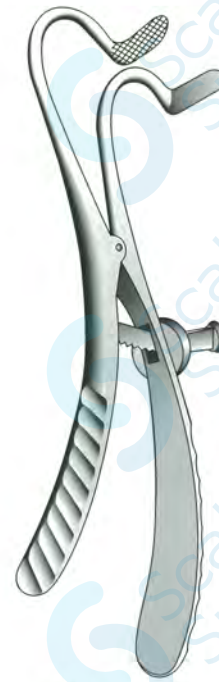

Mason

S-29-2550 Adult
S-29-2551 Child
Ackland Jaws

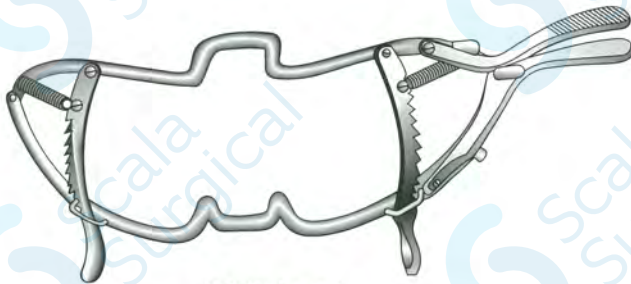

Whitehead

S-29-2553 4½", 11.5 cm
S-29-2554 5", 13 cm
S-29-2556 6", 15 cm



Jennings

S-29-2558 3½", 9 cm
S-29-2559 4½", 11 cm
S-29-2560 5", 13 cm
S-29-2561 6", 15 cm

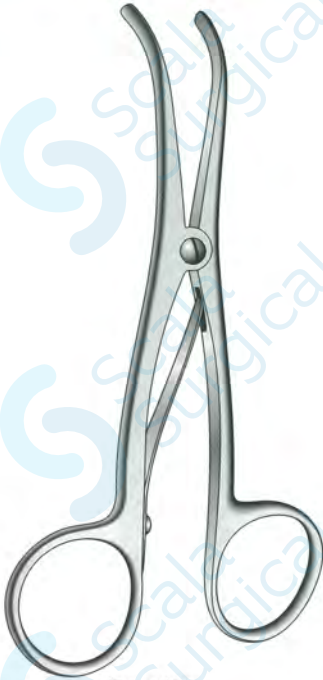

Bowlby
S-30-2500 Adult, 5½", 14 cm
S-30-2501 Child, 4½", 11.5 cm
Dilating Forceps



Trousseau
S-30-2504 Adult, 5½", 14 cm
S-30-2505 Child, 4½", 11.5 cm
Dilating Forceps

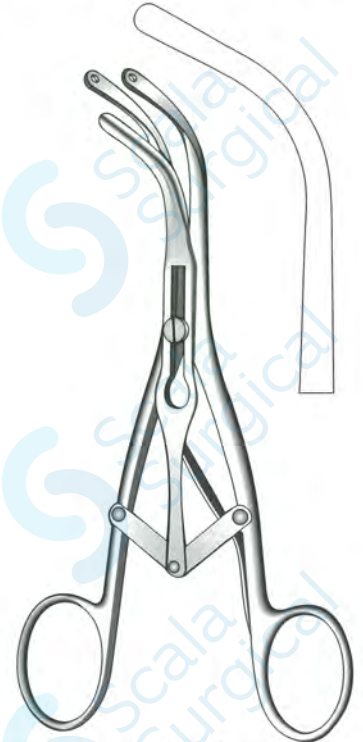

Laborde
S-30-2507
5½", 14 cm
Dilating Forceps

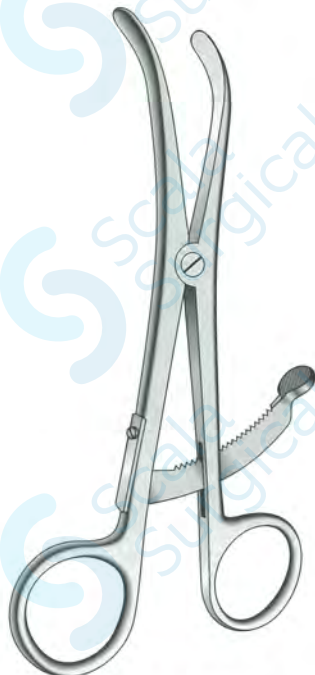

St. Clair Thomson
S-30-2509
5½", 14 cm
Dilating Forceps



Magill
S-30-2511
9½", 24 cm
Intra- Tracheal Forceps
Adult

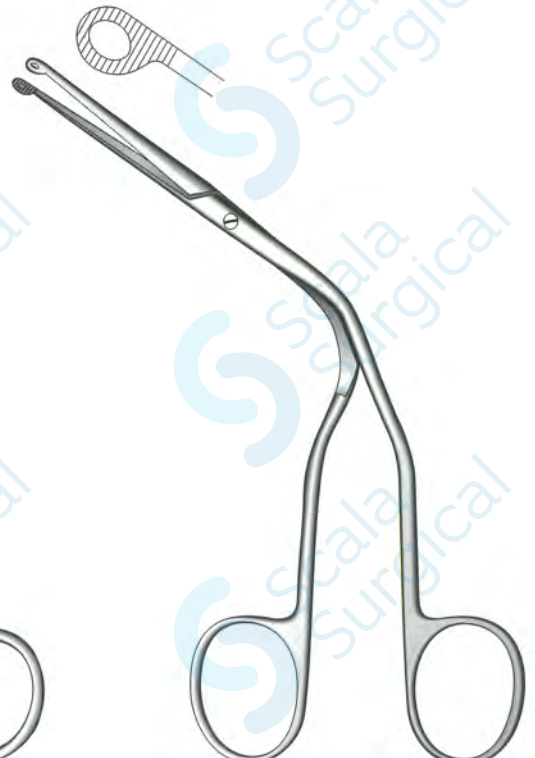

Magill
S-30-2513 Child, 8", 20 cm
S-30-2514 Infant, 6", 15 cm
Intra- Tracheal Forceps

Laryngeal & Dental Mirror

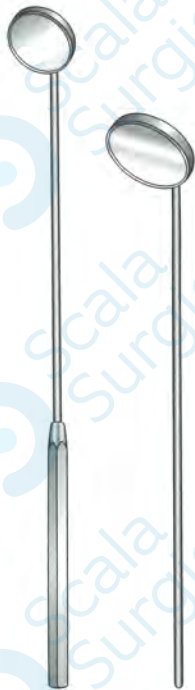

Laryngeal Mirrors



S-31-2501
Fig. 000
Ø 6 mm



S-31-2502
Fig. 00
Ø 8 mm



S-31-2503
Fig. 0
Ø 10 mm



S-31-2504
Fig. 1
Ø 12 mm



S-31-2506
Fig. 2
Ø 14 mm



S-31-2507
Fig. 3
Ø 16 mm



S-31-2508
Fig. 4
Ø 18 mm



S-31-2509
Fig. 5
Ø 20 mm



S-31-2510
Fig. 6
Ø 22 mm



S-31-2511
Fig. 7
Ø 24 mm



S-31-2512
Fig. 8
Ø 26 mm

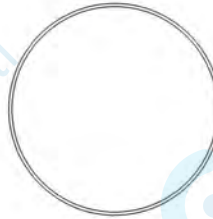

S-31-2513
Fig. 9
Ø 28 mm



S-31-2514
Fig. 10
Ø 30 mm



St. Clair

Thomson (Post Nasal Mirrors)

- S-31-2520-A Ø 6 mm
- S-31-2520-B Ø 8 mm
- S-31-2520-C Ø 10 mm
- S-31-2520-D Ø 12 mm
- S-31-2520-E Ø 14 mm
- S-31-2520-F Ø 16 mm
- S-31-2520-G Ø 18 mm
- S-31-2520-H Ø 20 mm
- S-31-2520-I Ø 22 mm
- S-31-2520-J Ø 24 mm
- S-31-2520-K Ø 26 mm
- S-31-2520-L Ø 28 mm
- S-31-2520-M Ø 30 mm



Handle
S-31-2522
Plain



Handle
S-31-2523
Knurled



Dental Mirror's
S-31-2525 No 4
S-31-2526 No 5

Laryngeal Biopsy Forceps

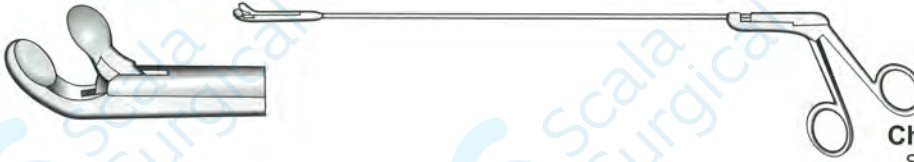

Chevalier Jackson

S-31-2550 11", 28 cm
 S-31-2551 13¾", 35 cm
 S-31-2552 15¾", 40 cm
 S-31-2553 19¾", 50 cm
 S-31-2554 21¾", 55 cm
 Vocal Nodule Forceps
 Cup Curved Upwards



Chevalier Jackson Laryngeal

S-31-2560 11¾", 30 cm
 S-31-2561 13¾", 35 cm
 S-31-2562 15¾", 40 cm
 S-31-2563 17¾", 45 cm
 S-31-2564 19¾", 50 cm
 Grasping Forceps, Light Weight



Royal National

S-31-2568
 13¾", 35 cm
 Throat, Nose & Ear Hospital Forceps
 Extra Fine

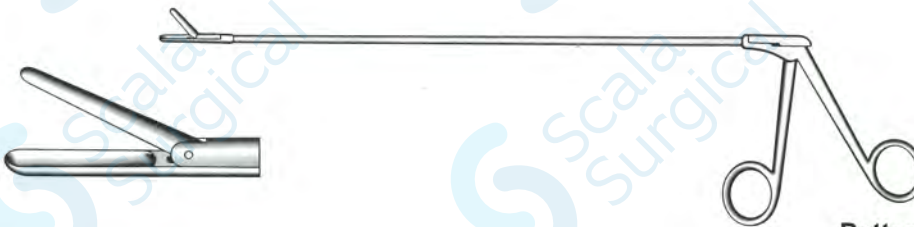

Patterson Biopsy Forceps

S-31-2570 11¾", 30 cm
 S-31-2571 13¾", 35 cm
 S-31-2572 15¾", 40 cm
 S-31-2573 17¾", 45 cm
 S-31-2574 19¾", 50 cm
 Light Weight

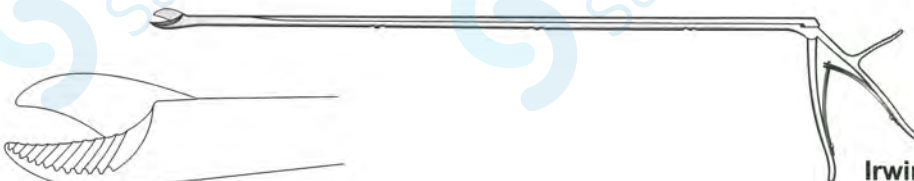

Irwin Moore Cutting Shears

S-31-2576
 20", 50.8 cm
 For cutting Large Foreign Bodies

Laryngeal Biopsy Forceps

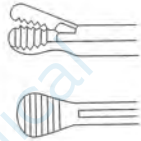

Chevalier Jackson
Laryngeal Forceps
S-31-2578
11 $\frac{1}{2}$ ", 30 cm
Flat Serrated Forceps Jaws for
removal of Papilloma

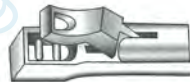
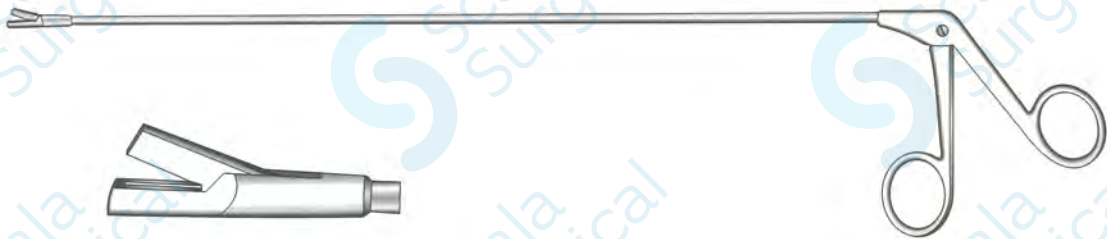

Chevalier Jackson
S-31-2580 11 $\frac{1}{2}$ ", 30 cm
S-31-2581 13 $\frac{1}{2}$ ", 35 cm
S-31-2582 16 $\frac{1}{2}$ ", 40 cm
S-31-2583 17 $\frac{1}{2}$ ", 45 cm
S-31-2584 19 $\frac{1}{2}$ ", 50 cm
Light weight, Basket Lower Jaw
Biopsy Forceps

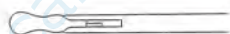

Straight



Cup Curved to Left



Cup Curved to Right



Cup Curved to upwards

Micro Laryngeal
S-31-2590 Straight
S-31-2591 Cup Curved to Left
S-31-2592 Cup Curved to Right
S-31-2593 Cup Curved to upwards
10", 25.5 cm
Foreign Body Removing Forceps
Round cup



Mackenzie
S-32-2500
8½", 21.5 cm
Screw Joint, Curved Laterally



Fraenkel
S-32-2502
7½", 19 cm
Screw Joint, Curved Laterally



Buck
S-32-2504
10½", 26.5 cm
Oesophageal Forceps



Jackson
S-32-2506
8¾", 22 cm
Tampon, Cross Action

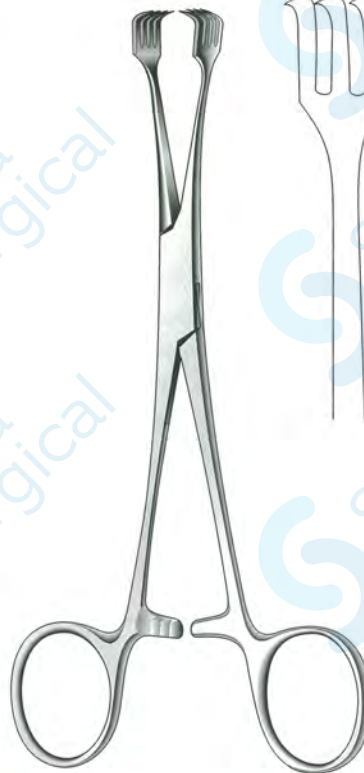

Lahey
S-32-2509 6½", 16 cm
S-32-2510 8", 20 cm
Goiter Seizing Forceps 3:3

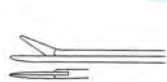

S-34-2501
Straight



S-34-2502
Curved Upwards

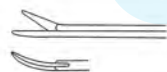

S-34-2503
Curved to Right

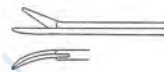

S-34-2504
Curved to Left

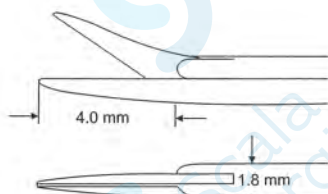

Cawthorne Scissors
3", 7.5 cm Shaft

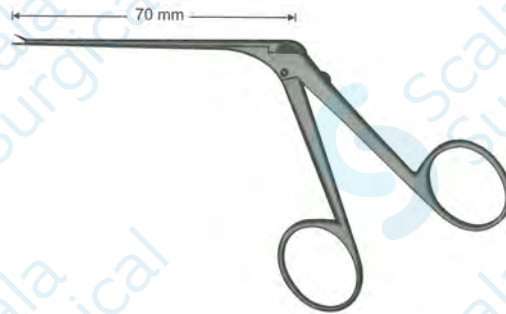
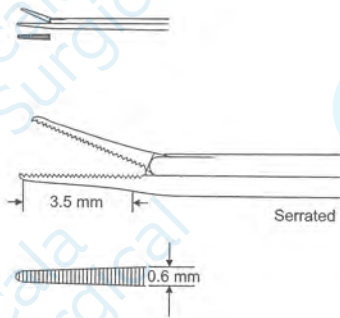

Beales
S-34-2516
Fine Triangular Serrated Jaws
7 cm Shaft, Black Finish

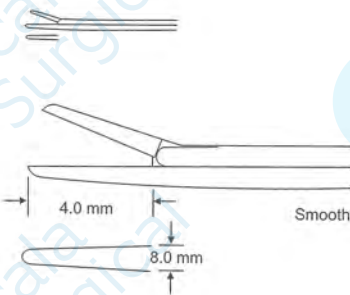

Cawthorne
S-34-2517 Stainless Steel Finish
S-34-2518 Black Finish
7 cm Shaft
Fine smooth Jaws

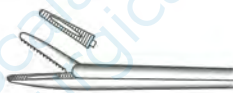

S-34-2520
Extra Fine Serrated Jaws



S-34-2521
Fine Tenaculum Jaws
with 1:2 teeth



S-34-2522
Round Cup Jaws



S-34-2523
Grunwald Jaws
With oval cup jaws 2 x 7 mm

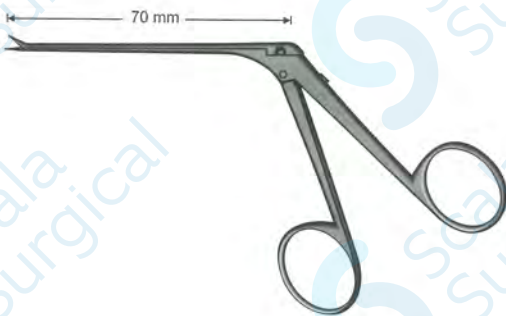

Hartmann
7 cm Shaft
Black Finish

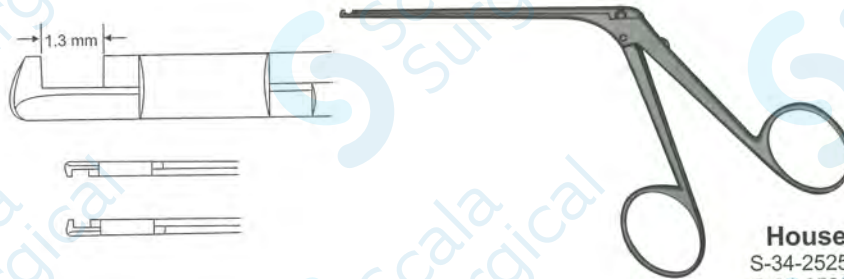

House Dieter

S-34-2525 Up Wards
S-34-2526 Down Wards
Fine 3" Shaft
Malleus Nipper

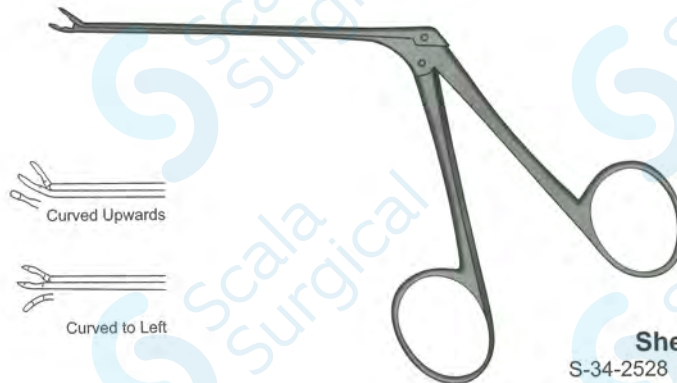
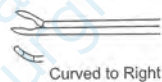
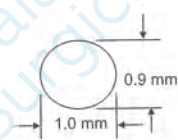

Shea

S-34-2528 Straight
S-34-2529 Curved Upwards
S-34-2530 Curved to Right
S-34-2531 Curved to Left
7 cm Shaft, Black Finish
Oval Cup Jaws

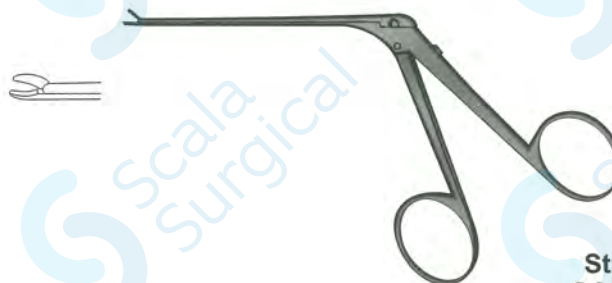

Stride

S-34-2532
Wiring Closing 7 cm Shaft, Black Finish
Wire Closing Forceps

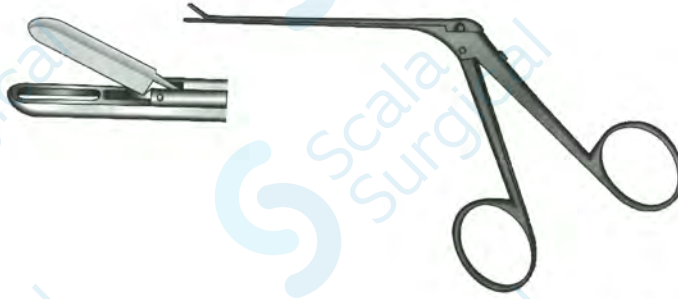

Ormerod
S-34-2534
Crocodile, Black Finish
Fine elongated cup
70 mm effective length

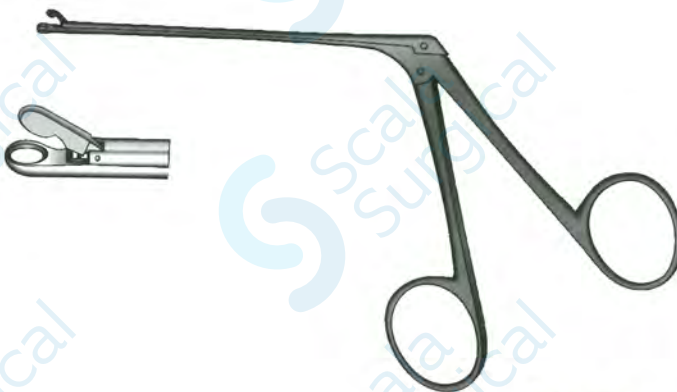

Ormerod
S-34-2535
Crocodile, Black Finish
Fine circular cup
70 mm effective length

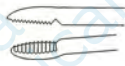

Hartmann Aural

S-34-2540 3", 7.6 cm to shoulder, overall length 5"
S-34-2541 4", 10 cm to shoulder, overall length 8"

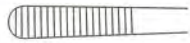
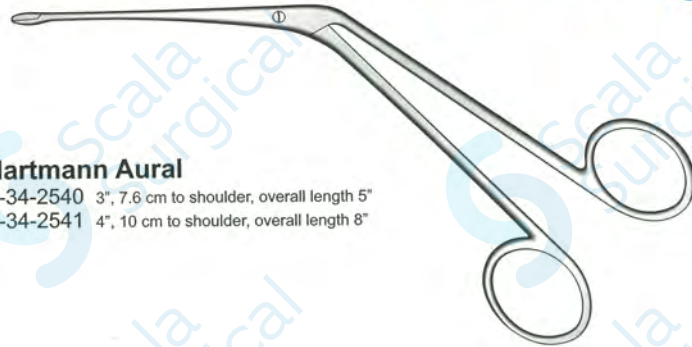

Cawthorne

S-34-2542
3 3/4", 9.5 cm to shoulder
Dressing Forceps



Heath Aural Forceps

S-34-2543
3", 7.6 cm to shoulder
With Lifting Disc

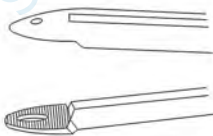

Heath Granulation Forceps

S-34-2544
3", 7.6 cm to shoulder
With Lifting Disc

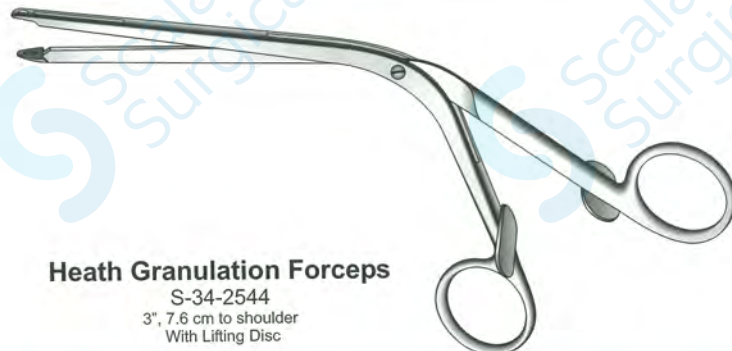

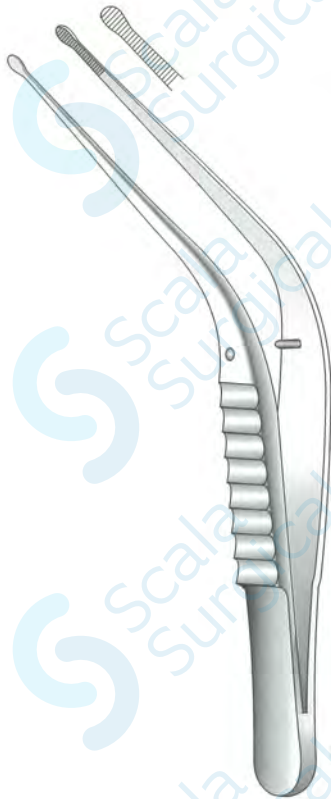

Hunter-Todd
S-34-2545
5", 13 cm
Probe end



Wilde
S-34-2547
5", 13 cm
Serrated Jaws



Keen
S-34-2549
5", 13 cm
1:2 Teeth



Lucae (Fagge)
S-34-2550
5½", 14 cm
Bayonet Shape

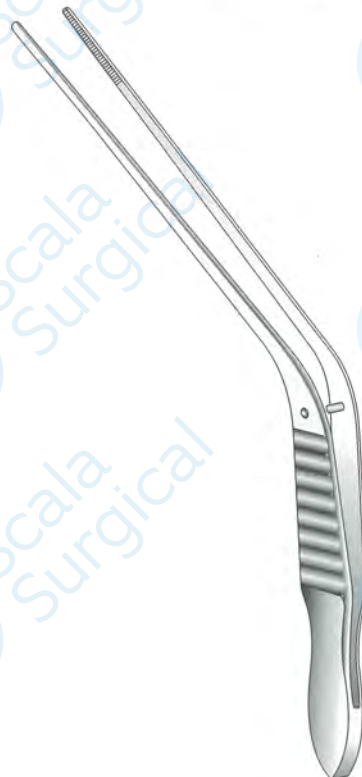

Cumberbatch
S-34-2552
5½", 14 cm

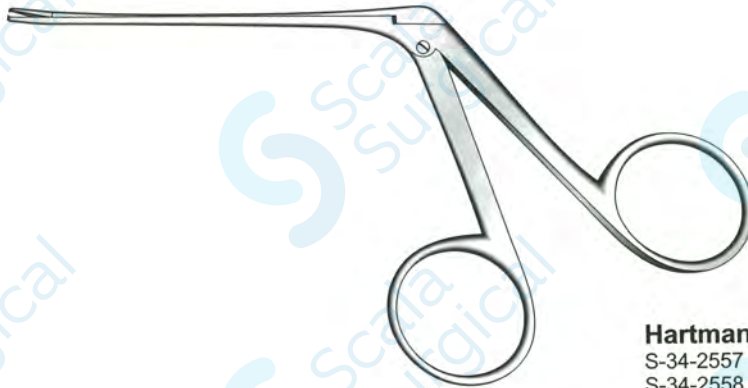

Hartmann (Fine)

S-34-2557 Serrated Jaws
S-34-2558 1:2 Teeth
S-34-2559 Spoon Jaws
85 mm Shaft
Crocodile Action

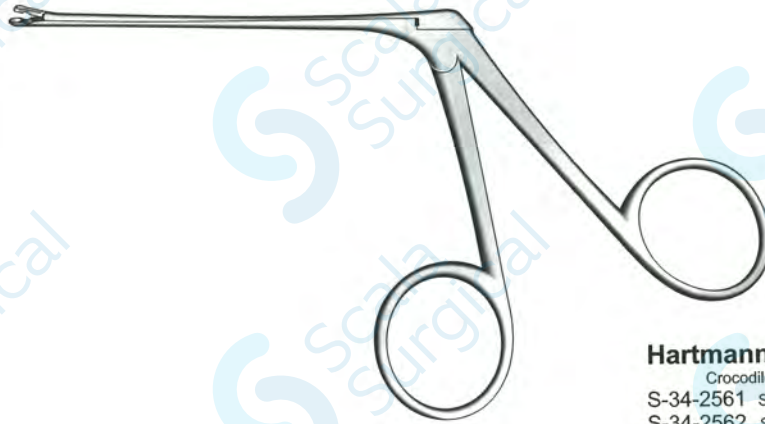

Hartmann (standard)

Crocodile Action
S-34-2561 Serrated, 5" Shaft
S-34-2562 Serrated, 5½" Shaft
S-34-2563 Cup Jaws, 5" Shaft

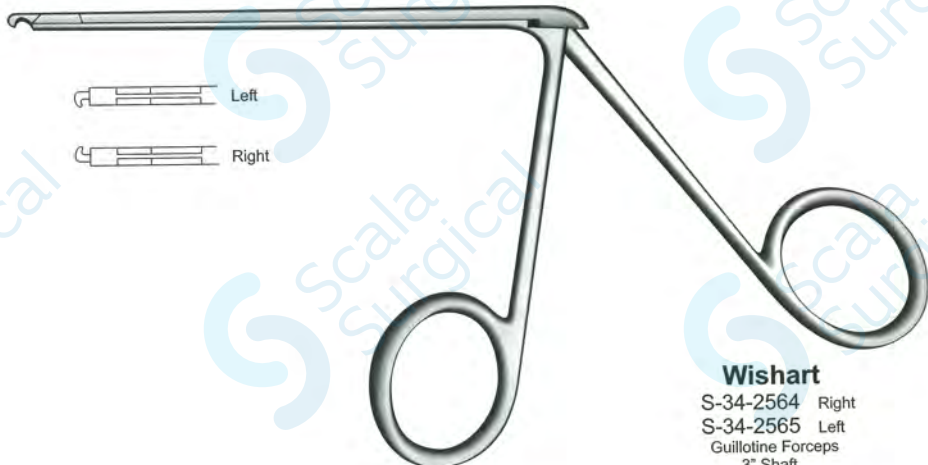

Wishart

S-34-2564 Right
S-34-2565 Left
Guillotine Forceps
3" Shaft

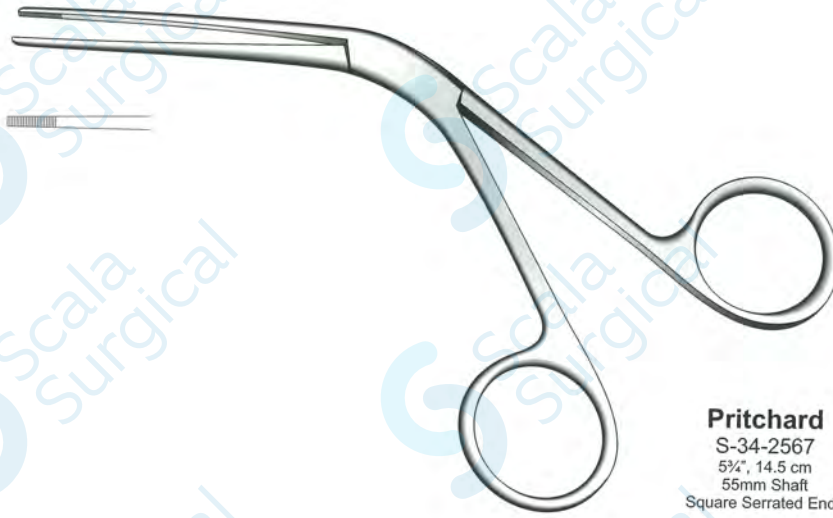

Pritchard
S-34-2567
5¾", 14.5 cm
55mm Shaft
Square Serrated Ends

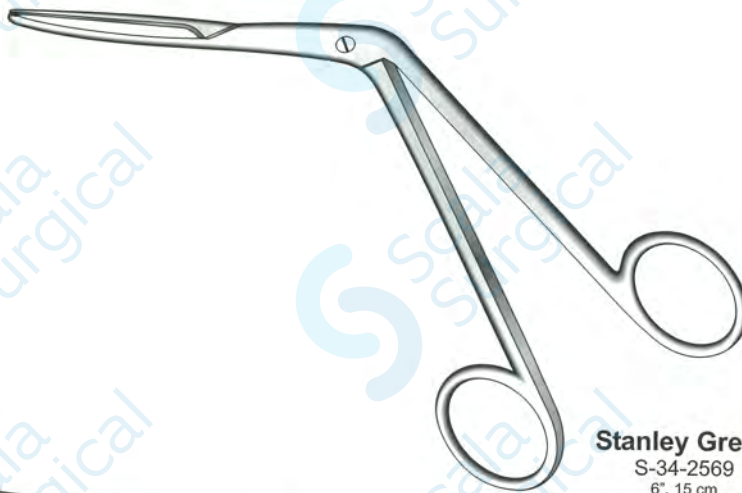

Stanley Green
S-34-2569
6", 15 cm
Plain Jaws, Screw Joints

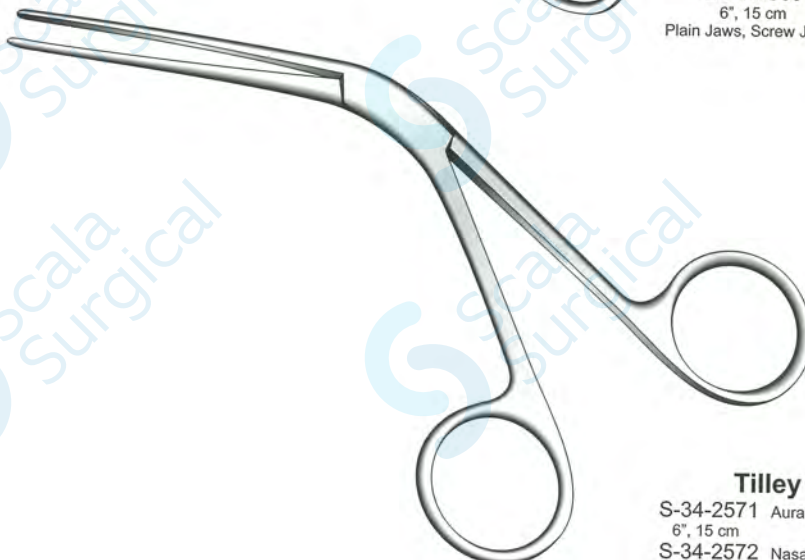

Tilley
S-34-2571 Aural, 65 mm to Elbow
6", 15 cm
S-34-2572 Nasal, 76 mm to Elbow
6½", 16.5 cm

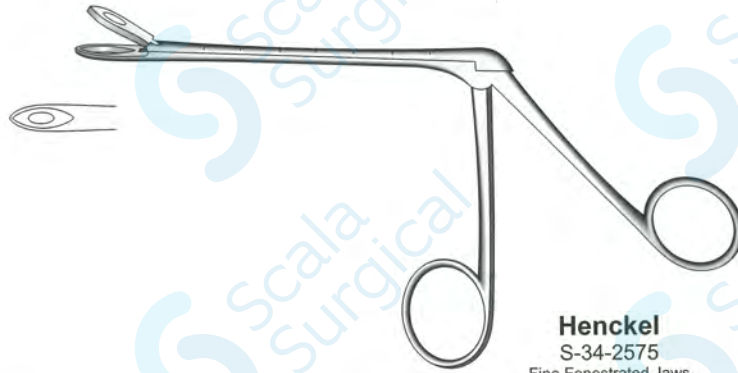

Henckel
S-34-2575
Fine Fenestrated Jaws
75 mm Shaft

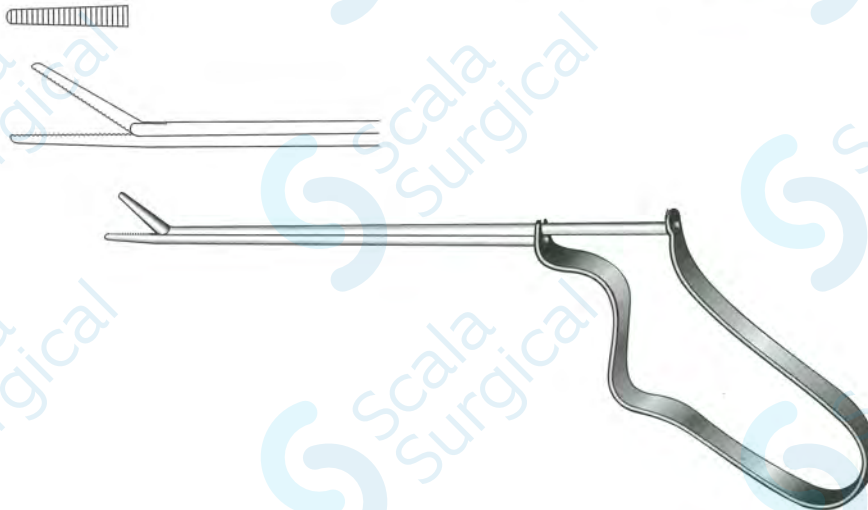

Buck
S-34-2577 100 mm Shaft
S-34-2578 140 mm Shaft
Crocodile Action



Quire
S-34-2579
4½", 115 mm Shaft



Hartmann

- S-34-2625 2 mm
- S-34-2626 2.5 mm
- S-34-2627 3 mm
- S-34-2628 4 mm
- S-34-2629 5 mm
- 5½", 14 cm
Cannula

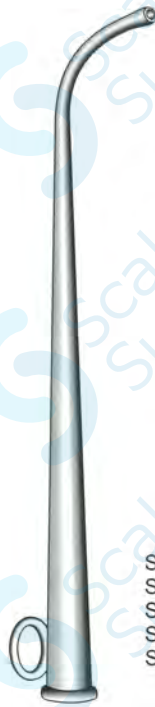

Itard

- S-34-2630 2 mm
- S-34-2631 2.5 mm
- S-34-2632 3 mm
- S-34-2633 4 mm
- S-34-2634 5 mm
- 5½", 14 cm
Cannula



Kramer

- S-34-2635 2 mm
- S-34-2636 2.5 mm
- S-34-2637 3 mm
- S-34-2638 4 mm
- S-34-2639 5 mm
- 5½", 14 cm
Cannula



Woakes

- S-34-2640 2 mm
- S-34-2641 2.5 mm
- S-34-2642 3 mm
- S-34-2643 4 mm
- S-34-2644 5 mm
- 5½", 14 cm
Cannula



Troeltsch

- S-34-2645 2 mm
- S-34-2646 2.5 mm
- S-34-2647 3 mm
- S-34-2648 4 mm
- S-34-2649 5 mm
- 5½", 14 cm
Cannula



Barker

- S-34-2655 Straight Single Ended
- S-34-2656 Curved Single Ended
- S-34-2657 Double Ended
- 5¾", 14.5 cm
Curette

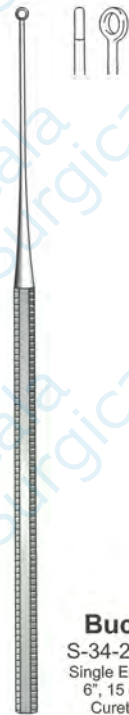

- Buck**
S-34-2658
Single Ended
6", 15 cm
Curette

Ent Instruments



Cawthorne
S-34-2659
Cerumen Hook
Curved 5¼", 14.5 cm



McEvans
S-34-2661
Curette/seeker
Double Ended 7¼", 18.5 cm



Cawthorne
S-34-2665
Hook
Curved 6½", 16.5 cm



Fig. 1



Fig. 2



Fig. 3



Fig. 4



Fig. 5



Fig. 6



Fig. 7

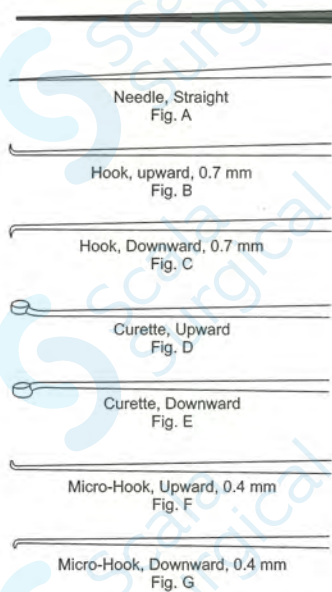

Fig. 8



Fig. 9

Rosen
S-34-2666
Set of 9



Portmann / Clavierie
S-34-2667
Stapedectomy Instruments
Black Finish
Set of 7
Fig A-Fig G



Rosen
S-34-2668
Scoop Oval Size Zero

Rosen
S-34-2669
1.5 mm
8 3/4", 19.5 cm
Elevator

Rosen
S-34-2670
2 mm
8 3/4", 19.5 cm
Elevator

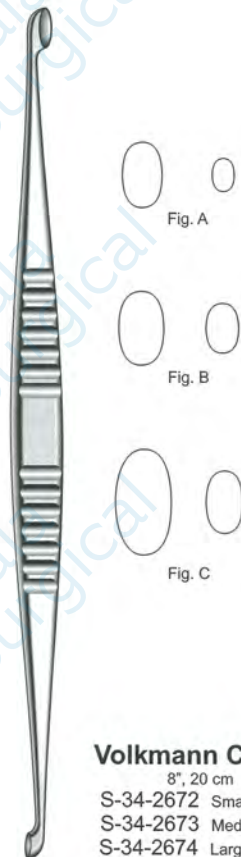
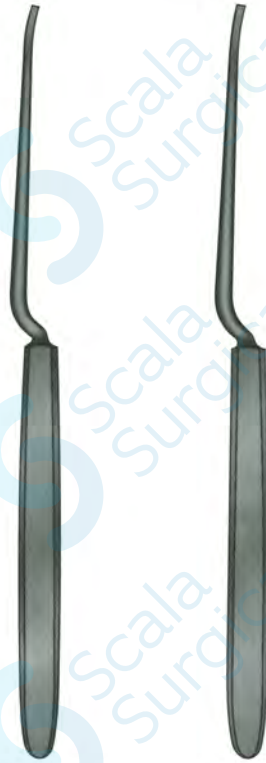

Volkmann Curette
8", 20 cm
S-34-2672 Small, Fig. A
S-34-2673 Medium, Fig. B
S-34-2674 Large, Fig. C



House Curette
S-34-2675 Fine Straight
S-34-2676 Fine Curved





Fig. 00



Fig. 0



Fig. 1



Fig. 2



Fig. 3



Fig. 4



Fig. 5



Fig. 6

Volkmann

- | | | | |
|-----------|---------|-----------|--------|
| S-34-2680 | Size 00 | S-34-2684 | Size 3 |
| S-34-2681 | Size 0 | S-34-2685 | Size 4 |
| S-34-2682 | Size 1 | S-34-2686 | Size 5 |
| S-34-2683 | Size 2 | S-34-2687 | Size 6 |
- Curette, Single Ended



Fig. 0000



Fig. 000



Fig. 00



Fig. 0



Fig. 1



Fig. 2



Fig. 3



Fig. 4

Lempert

- | | | | |
|-----------|-----------|-----------|--------|
| S-34-2690 | Size 0000 | S-34-2694 | Size 1 |
| S-34-2691 | Size 000 | S-34-2695 | Size 2 |
| S-34-2692 | Size 00 | S-34-2696 | Size 3 |
| S-34-2693 | Size 0 | S-34-2697 | Size 4 |
- Curette, Single Ended

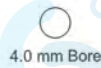
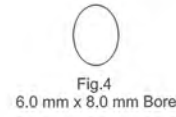

Gruber

- S-34-2701 Fig.1, 2.5 mm x 3.5 mm Bore
- S-34-2702 Fig.2, 3.5 mm x 4.5 mm Bore
- S-34-2703 Fig.3, 4.0 mm x 6.0 mm Bore
- S-34-2704 Fig.4, 6.0 mm x 8.0 mm Bore
- S-34-2705 Set of 3 (No. 1 to No. 3)
- S-34-2706 Set of 4 (No. 1 to No. 4)
- S-34-2708 3.0 mm Bore
- S-34-2709 4.0 mm Bore
- S-34-2710 5.0 mm Bore
- S-34-2711 7.0 mm Bore
- S-34-2712 Set of 3 (3.0 mm to 5.0 mm)
- S-34-2713 Set of 4 (3.0 mm to 7.0 mm)
- 38 mm, Aural Speculum, Oval end, Black Finish

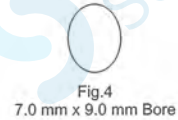
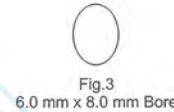
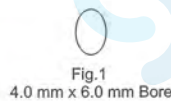

Heath

- S-34-2715 Fig.1, 4.0 mm x 6.0 mm Bore
- S-34-2716 Fig.2, 5.0 mm x 7.0 mm Bore
- S-34-2717 Fig.3, 6.0 mm x 8.0 mm Bore
- S-34-2718 Fig.4, 7.0 mm x 9.0 mm Bore
- S-34-2719 Set of 4
- 48 mm, Oval end, Black Finish
- Aural Speculum



Tumarkin

- S-34-2720 Fig. 0, 3.5 mm Bore
- S-34-2721 4.5 mm Bore
- S-34-2722 Fig. 1, 5.5 mm Bore
- S-34-2723 Fig. 2, 6.0 mm Bore
- S-34-2724 Fig. 3, 6.5 mm Bore
- S-34-2725 Fig. 4, 7.0 mm Bore
- S-34-2726 Fig. 5, 7.5 mm Bore
- S-34-2727 Fig. 6, 8.0 mm Bore
- S-34-2728 Fig. 7, 10.0 mm Bore
- S-34-2729 Set of 8 (Fig. 0 to Fig. 7)
- 51 mm
- Tapered Slot, Black Finish
- Aural Speculum

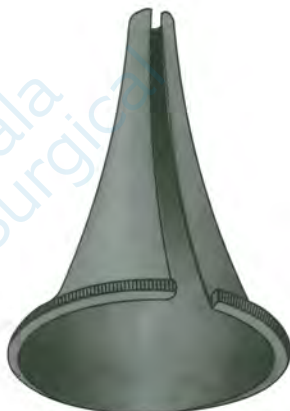



Rosen

- S-34-2735 Fig.1, 2.5 mm x 3.5 mm Bore
- S-34-2736 Fig.2, 3.5 mm x 4.5 mm Bore
- S-34-2737 Fig.3, 4.0 mm x 6.0 mm Bore
- S-34-2738 Fig.4, 5.0 mm x 7.0 mm Bore
- S-34-2739 Fig.5, 6.0 mm x 8.0 mm Bore
- S-34-2740 Set of 4, Fig.2 - Fig.5
- S-34-2741 Set of 5, Fig.1 - Fig.5
Slotted, Oval End, Black Finish, 38 mm
- S-34-2742 Fig.1, 3.0 mm Bore
- S-34-2743 Fig.2, 4.0 mm Bore
- S-34-2744 Fig.3, 5.0 mm Bore
- S-34-2745 Fig.4, 6.0 mm Bore
- S-34-2746 Fig.5, 7.0 mm Bore
- S-34-2747 Set of 4, Fig.2 - Fig.5
- S-34-2748 Set of 5, Fig.1 - Fig.5
Slotted, Round End, Black Finish, 38 mm
Aural Speculum



Rosen

- S-34-2750 Fig.1, 2.5 mm x 3.5 mm Bore
- S-34-2751 Fig.2, 3.5 mm x 4.5 mm Bore
- S-34-2752 Fig.3, 4.0 mm x 6.0 mm Bore
- S-34-2753 Fig.4, 5.0 mm x 7.0 mm Bore
- S-34-2754 Fig.5, 6.0 mm x 8.0 mm Bore
- S-34-2755 Set of 4, Fig.2 - Fig.5
- S-34-2756 Set of 5, Fig.1 - Fig.5
Unslotted, Oval End, Black Finish, 38 mm
- S-34-2757 Fig.1, 3.0 mm Bore
- S-34-2758 Fig.2, 4.0 mm Bore
- S-34-2759 Fig.3, 5.0 mm Bore
- S-34-2760 Fig.4, 6.0 mm Bore
- S-34-2761 Fig.5, 7.0 mm Bore
- S-34-2762 Set of 4, Fig.2 - Fig.5
- S-34-2763 Set of 5, Fig.1 - Fig.5
Unslotted, Round End, Black Finish, 38 mm
Aural Speculum



Shea

- S-34-2770 Fig. 1, 3.3 mm x 4.1 mm Bore
- S-34-2771 Fig. 2, 4.0 mm x 5.5 mm Bore
- S-34-2772 Fig. 3, 5.0 mm x 7.5 mm Bore
- S-34-2773 Fig. 4, 6.0 mm x 8.5 mm Bore
- S-34-2774 Fig. 5, 7.0 mm x 9.5 mm Bore
- S-34-2775 Set of 5
Oblique End, Black Finish, 38 mm
Aural Speculum,

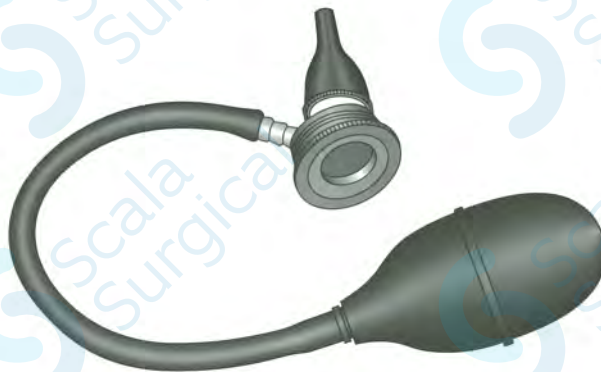

Peters (Siegle)

- S-34-2780 Complete, Plain, with ear Specula, Rubber Tube & Bulb
- S-34-2781 Fig. 0, 3.0 mm x 4.0 mm Bore
- S-34-2782 Fig. 1, 4.0 mm x 5.0 mm Bore
- S-34-2783 Fig. 2, 4.5 mm x 6.0 mm Bore
- S-34-2784 Fig. 3, 5.5 mm x 7.0 mm Bore
- S-34-2785 Fig. 4, 6.5 mm x 8.0 mm Bore
- S-34-2786 Set of 4 (Fig. 1 - Fig. 4)
- S-34-2787 Set of 5 (Fig. 0 - Fig. 4)
Oval end, Black Finish, 42 mm
Aural Speculum



Toynee

- S-34-2789 Set of 4
- S-34-2790 Fig. 1, 4.0 mm Bore
- S-34-2791 Fig. 2, 5.0 mm Bore
- S-34-2792 Fig. 3, 6.0 mm Bore
- S-34-2793 Fig. 4, 7.0 mm Bore
Black Finish, 41 mm
Aural Speculum

Aural Speculum, Stainless Steel

Fig. 0

Fig. 1

Fig. 1

Fig. 2

Fig. 2

Fig. 3

Fig. 4

Fig. 3



Hartmann

- S-34-2795 Fig. 0, 3 mm Ø
- S-34-2796 Fig. 1, 4.5 mm Ø
- S-34-2797 Fig. 2, 5.5 mm Ø
- S-34-2798 Fig. 3, 6.5 mm Ø
- S-34-2799 Fig. 4, 7.5 mm Ø



Toynbee

- S-34-2801 Fig. 1, 5.5 mm Ø
- S-34-2802 Fig. 2, 6.5 mm Ø
- S-34-2803 Fig. 3, 7.5 mm Ø

4.5 mm Ø
Fig.1

5.5 mm Ø
Fig.2

Fig. 1

Fig. 2

6.5 mm Ø
Fig.3

7.5 mm Ø
Fig.4

Fig. 3

Fig. 4



Gruber

- S-34-2805 Fig. 1, 4.5 mm Ø
- S-34-2806 Fig. 2, 5.5 mm Ø
- S-34-2807 Fig. 3, 6.5 mm Ø
- S-34-2808 Fig. 4, 7.5 mm Ø
- Oval



Gruber

- S-34-2810 Fig. 1, 4.5 mm Ø
- S-34-2811 Fig. 2, 5.5 mm Ø
- S-34-2812 Fig. 3, 6.5 mm Ø
- S-34-2813 Fig. 4, 7.5 mm Ø
- Round



Noots
S-34-2815
Ear Tank

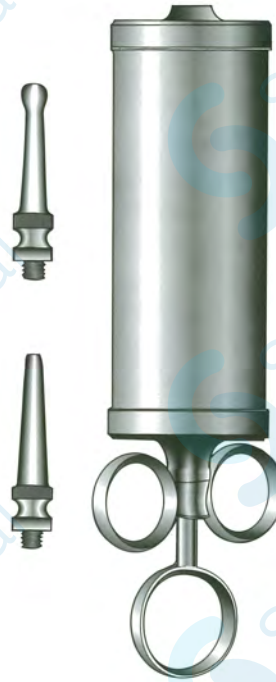

Aural
S-34-2820 2 oz., 50 cc
S-34-2821 3 oz., 75 cc
S-34-2822 4 oz., 100 cc
S-34-2823 6 oz., 150 cc
S-34-2824 8 oz., 200 cc
Syringe



Bacon Syringe
S-34-2830



Poltzer
S-34-2840
Insufflator with 3 Nasal Tips & Connector

Connecting nozzle

Ent Instruments



Formby
S-34-2845
17.5 cm



Lucae

- S-34-2847 Small
 - S-34-2848 Medium
 - S-34-2849 Large
- 5½", 14 cm

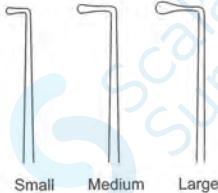

St. Barts
S-34-2851
17.5 cm
Blunt



Dundas Grant
S-34-2853
Seeker



Musgrove
S-34-2855
17.5 cm



Heath
S-34-2857
17 cm
Fine

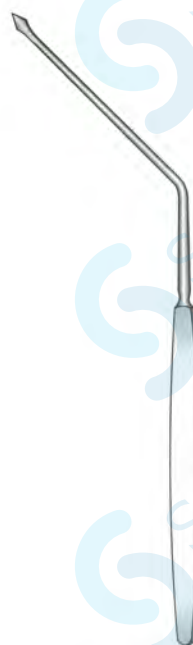

Agnew Myringotome
S-34-2859

Ent Instruments

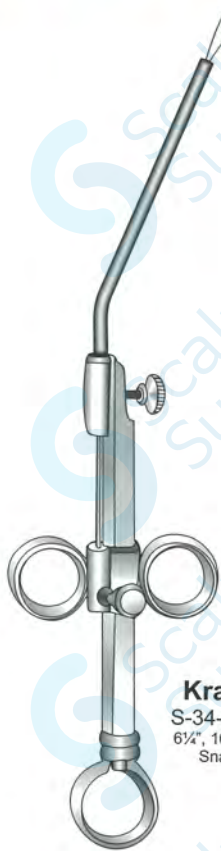

Kraus
S-34-2862
6 1/4", 16.5 cm
Snare

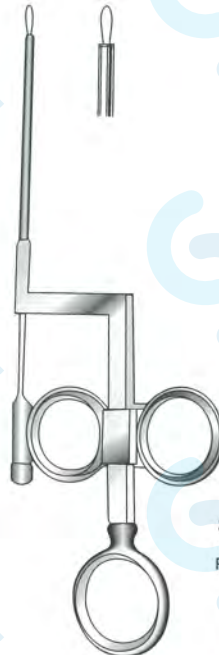

Wilde
S-34-2864
6 1/4", 16.5 cm
Polypus Snare

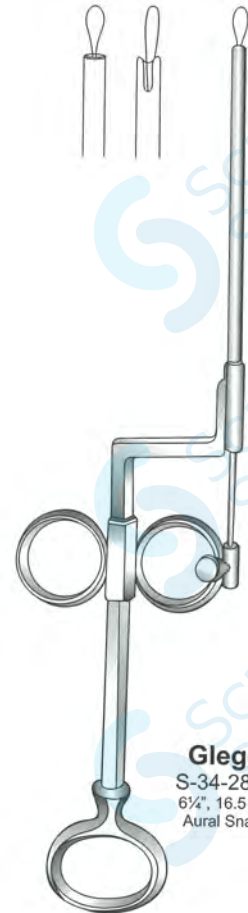

Glegg
S-34-2866
6 1/4", 16.5 cm
Aural Snare

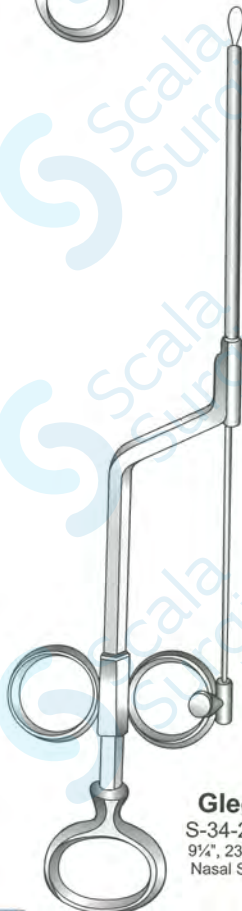

Glegg
S-34-2868
9 1/4", 23.5 cm
Nasal Snare

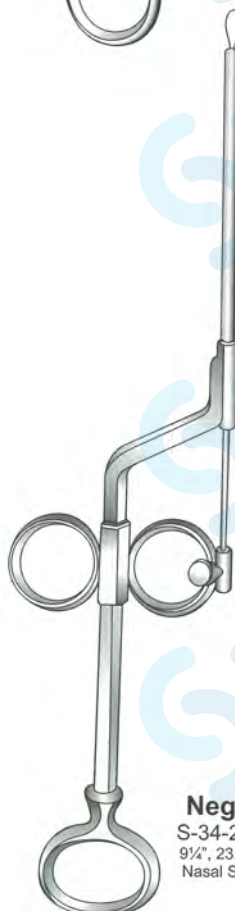

Negus
S-34-2870
9 1/4", 23.5 cm
Nasal Snare



Eves
S-34-2872
11", 28 cm
Tonsil Snare

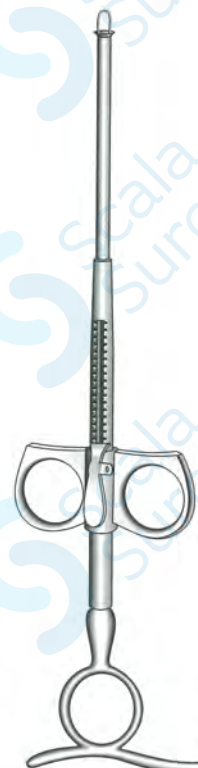

Eve
S-34-2874
11", 28 cm
Tonsil Snare
Ratchet Type
Chrome Plated

Ent Instruments

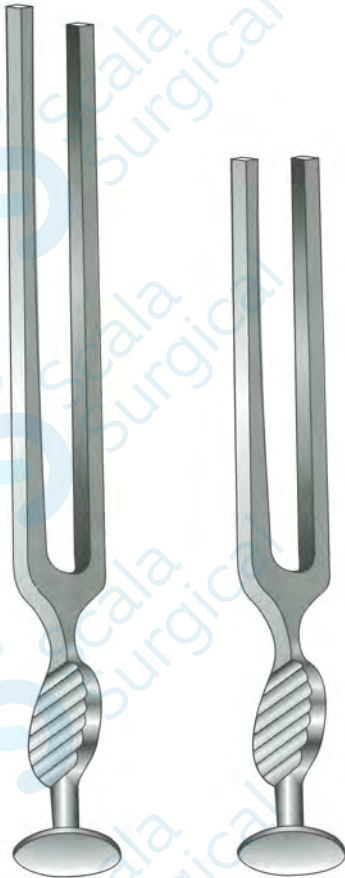

S-34-2880
C° 128 d.v.

S-34-2881
C° 256 d.v.

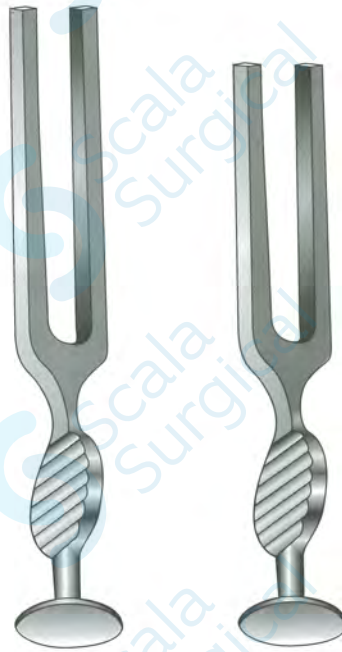

S-34-2882
C° 512 d.v.

S-34-2883
C° 1024 d.v.

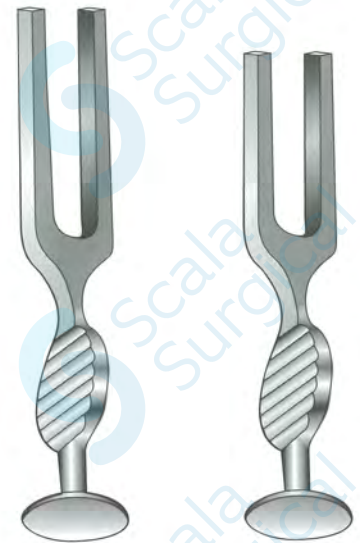

S-34-2884
C° 2048 d.v.

S-34-2885
C° 4096 d.v.

Gardiner Brown

S-34-2886
Tuning Forks
Set of 6



S-34-2890
C° 128 d.v

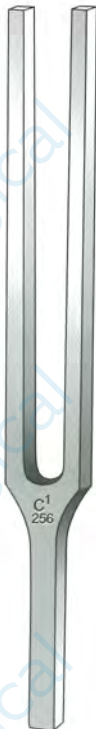

S-34-2891
C° 256 d.v



S-34-2892
C° 512 d.v



S-34-2893
C° 1024 d.v



S-34-2894
C° 2048 d.v



S-34-2895
C° 4096 d.v

Hartmann
S-34-2896
Tuning Forks
Set of 6

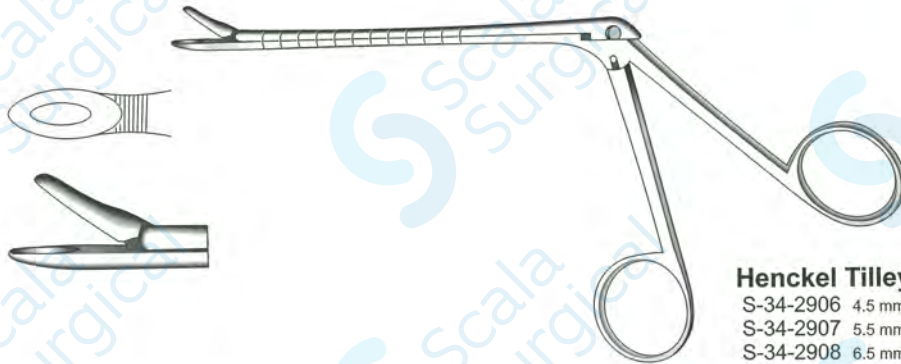

Henckel Tilley

- S-34-2906 4.5 mm
- S-34-2907 5.5 mm
- S-34-2908 6.5 mm
- S-34-2909 8.0 mm
- 11.2 cm Shaft

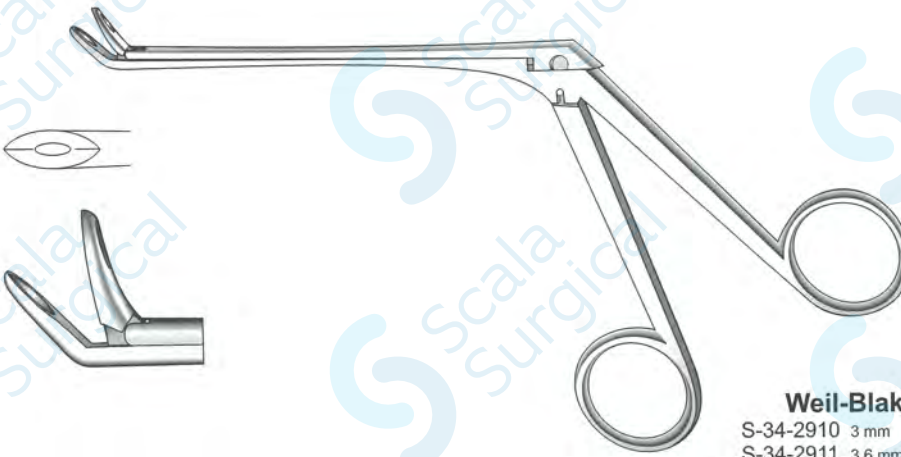

Weil-Blakesley

- | | |
|------------------|-------------------|
| S-34-2910 3 mm | S-34-2915 |
| S-34-2911 3.6 mm | S-34-2916 |
| S-34-2912 4.2 mm | S-34-2917 |
| S-34-2913 5.8 mm | S-34-2918 |
| Straight Jaws | Angled Upward Jaw |
| 11.2 cm Shaft | |

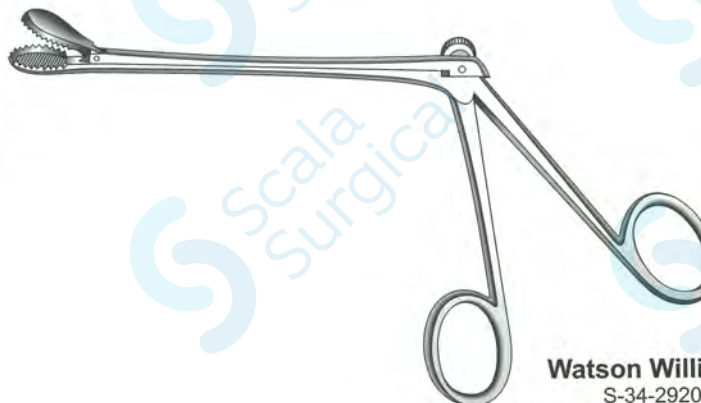

Watson Williams

- S-34-2920
- With Multiple Toothed Jaw

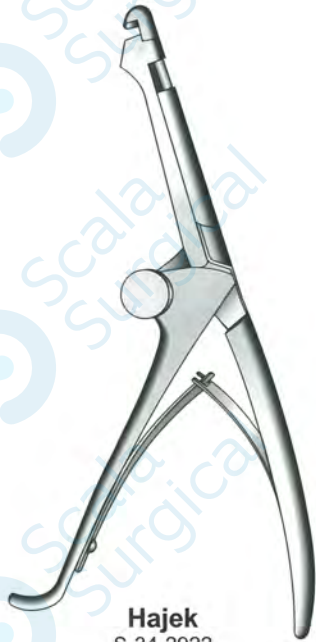

Hajek
S-34-2922
195 mm

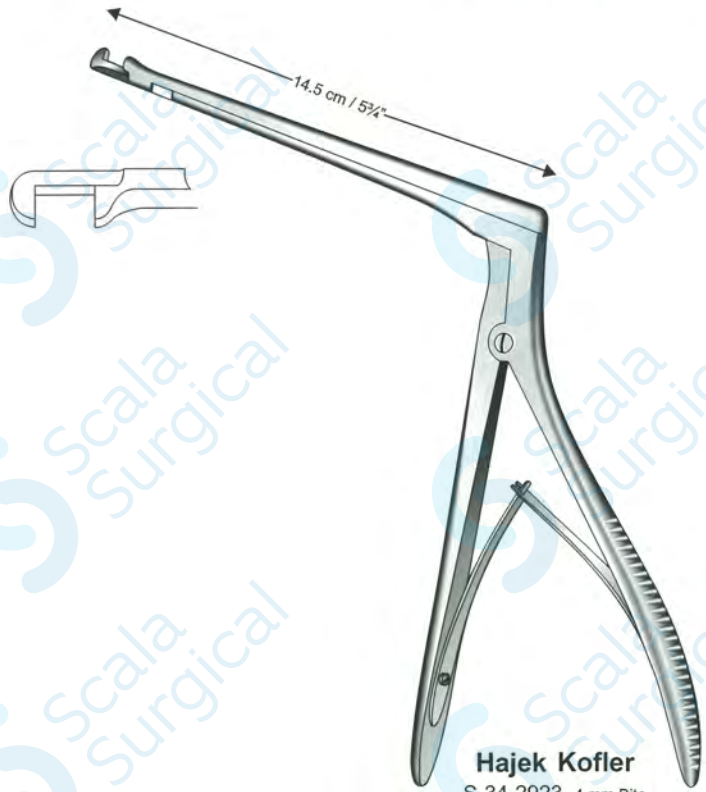

Hajek Kofler
S-34-2923 4 mm Bite
S-34-2924 5 mm Bite
Upward Cutting, 145 mm Effective Length
S-34-2925 4 mm Bite
S-34-2926 5 mm Bite
Downward Cutting, 145 mm Effective Length



Citelli
S-34-2927 2 mm Bite, 73 mm Effective Length
S-34-2928 4 mm Bite, 75 mm Effective Length

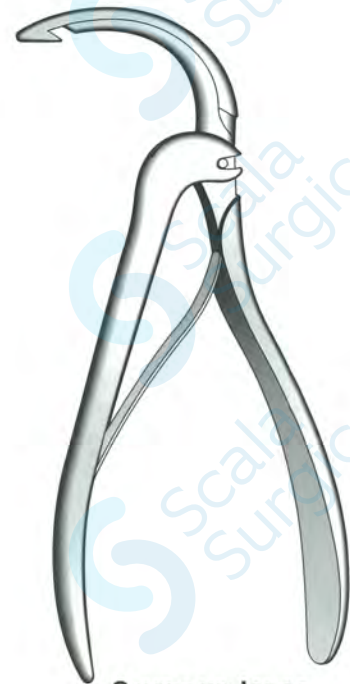

Seymour Jones
S-34-2929
160 mm

Ent Instruments



Irwin Moore
S-34-2930
7½", 19 cm
Screw Joint



Middleton-Jansen
S-34-2931
7½", 19 cm

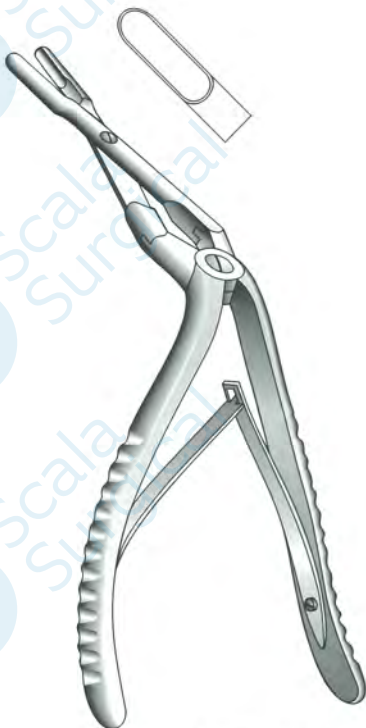

Middleton-Jansen
S-34-2932
7½", 19 cm

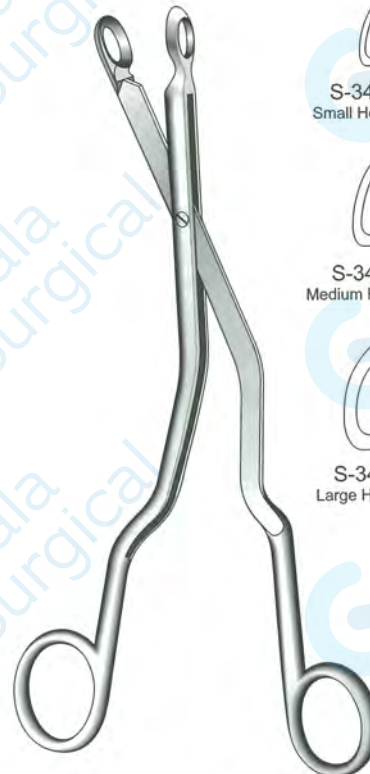

Luc
Cut through joint
7", 18 cm





Myles
S-34-2939
7½", 19 cm
Punch, 12 mm shaft



Ostrum
S-34-2940
7", 18 cm
Antrum Punch
Forward Cutting



Struycken
S-34-2941 76 mm Shaft
S-34-2942 100 mm Shaft
7½", 19 cm
Punch

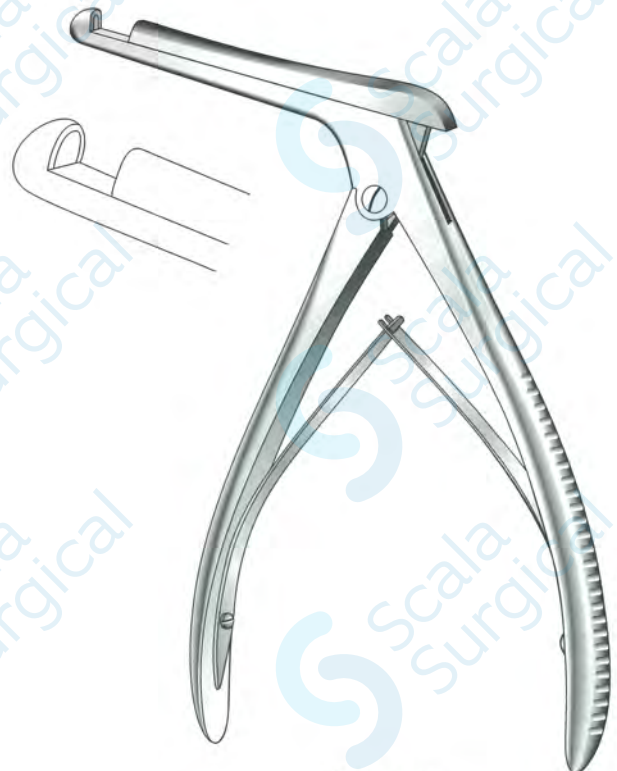

Kerrison
S-34-2943 3 mm Bite
S-34-2944 5 mm Bite
Shaft 3½", 9 cm
Punch

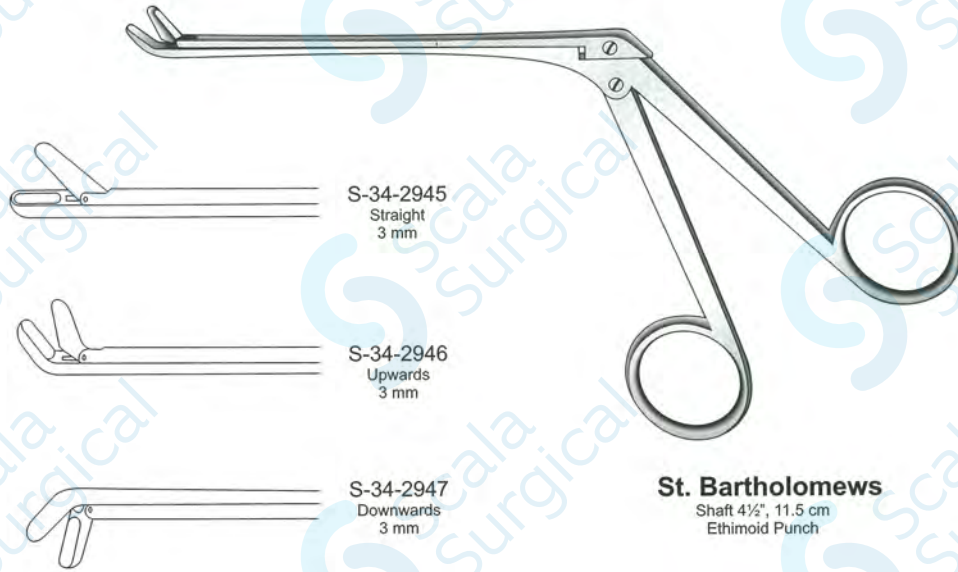

S-34-2945
Straight
3 mm

S-34-2946
Upwards
3 mm

S-34-2947
Downwards
3 mm

St. Bartholomews
Shaft 4½", 11.5 cm
Ethmoid Punch

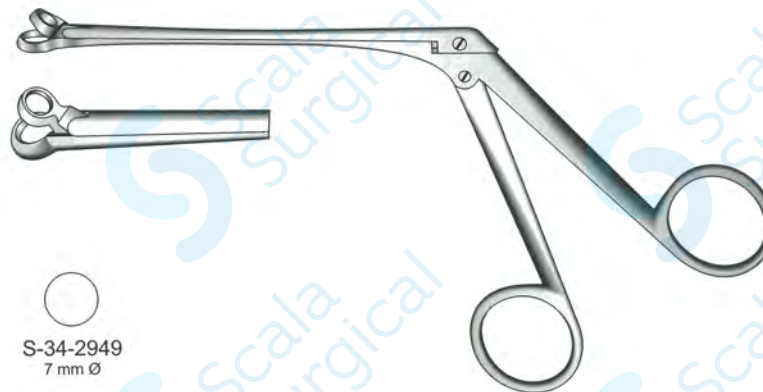

S-34-2948
5 mm Ø

S-34-2949
7 mm Ø

Hartmann (Cronchiotome)
85 mm Shaft
Crocodile Action
Circular Cutting 5 mm

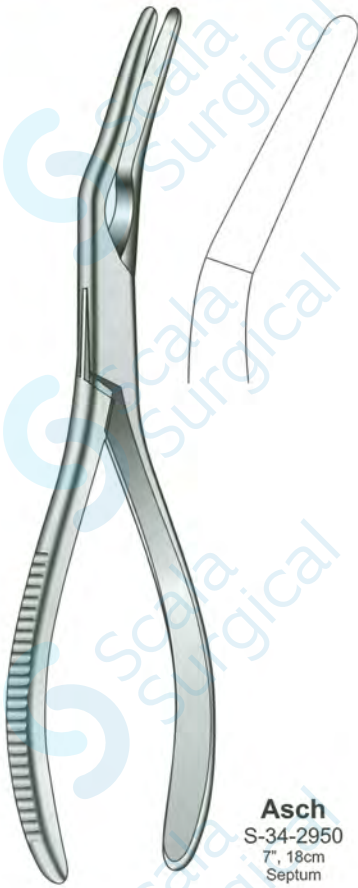

Asch
S-34-2950
7", 18cm
Septum



Rowe Deschamp
S-34-2951
8½", 22 cm
Left, Septum



Rowe Deschamp
S-34-2952
8½", 22 cm
Right, Septum

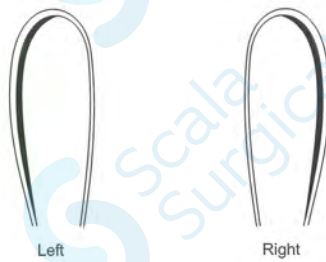

Walsham Redressing Forceps
S-34-2953 Straight
S-34-2954 Right
S-34-2955 Left
8½", 22 cm





Beckman
8½", 21.5 cm
Adenoid Curettes

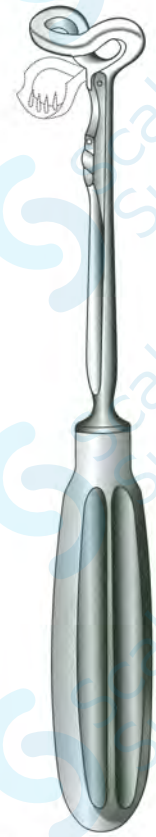
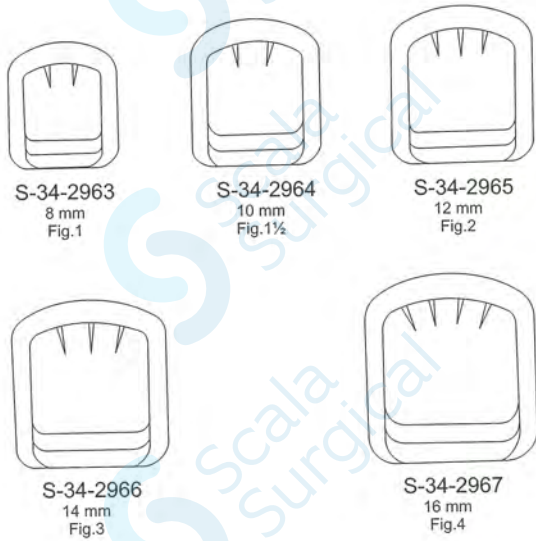

St.Clair-Thomson
With Cage
Adenoid Curette

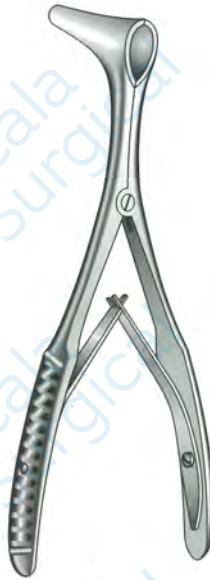

Vienna



S-34-2968
Small
Fig. 1



S-34-2969
Medium
Fig. 2



S-34-2970
Large
Fig. 3



Cottle

- S-34-2971 20 mm Blade
- S-34-2972 32 mm Blade
- S-34-2973 41 mm Blade
- S-34-2974 60 mm Blade
- Blackened
Nasal Speculum



Killian

- S-34-2975 55 mm Blade
- S-34-2976 65 mm Blade
- S-34-2977 75 mm Blade
- S-34-2978 90 mm Blade
- Plain
Nasal Speculum



Killian

- S-34-2979 55 mm Blade
- S-34-2980 65 mm Blade
- S-34-2981 75 mm Blade
- S-34-2982 90 mm Blade
- Insulated
Nasal Speculum

Nasal Speculum



St. Clair Thomson

- S-34-2984 38 mm Blade
- S-34-2985 50 mm Blade
- S-34-2986 65 mm Blade
- S-34-2987 75 mm Blade
- S-34-2988 Set of 4 Blade Nasal Speculum



St. Clair Thomson

- S-34-2989 38 mm Blade
- S-34-2990 50 mm Blade
- S-34-2991 65 mm Blade
- S-34-2992 75 mm Blade
- S-34-2993 Set of 4 Blades Insulated Nasal Speculum



Shah

- S-34-2994 Left Nasal Speculum



Shah

- S-34-2995 Right Nasal Speculum



Shah

- S-34-2996 Left Insulated Nasal Speculum



Shah

- S-34-2997 Right Insulated Nasal Speculum



Thudichum

- S-34-3000 Size 1, 12 mm
- S-34-3001 Size 2, 14 mm
- S-34-3002 Size 3, 16 mm
- S-34-3003 Size 4, 18 mm
- S-34-3004 Size 5, 20 mm
- S-34-3005 Size 6, 22 mm
- S-34-3006 Size 7, 24 mm
- S-34-3007 Size 8, 27 mm
- S-34-3008 Set of 5, Size 4 to 8
- S-34-3009 Set of 7, Size 1 to 7
70 mm, Deep Blade
Nasal Speculum



Thudichum

- S-34-3010 Size 1, 12 mm
- S-34-3011 Size 2, 14 mm
- S-34-3012 Size 3, 16 mm
- S-34-3013 Size 4, 18 mm
- S-34-3014 Size 5, 20 mm
- S-34-3015 Size 6, 22 mm
- S-34-3016 Size 7, 24 mm
- S-34-3017 Size 8, 27 mm
- S-34-3018 Set of 5, Size 4 to 8
- S-34-3019 Set of 7, Size 1 to 7
70 mm, Deep Blade, Insulated
Nasal Speculum

Ent Instruments



Denis Borwne
S-34-3022 7", 18 cm
S-34-3023 8½", 21.5 cm
Tonsil Seizing



Denis Borwne
S-34-3024
Tonsil / Ligature Seizing
8", 20 cm



Ballenger
S-34-3026
8¾", 23 cm
Tonsil, Vulsellum Forceps

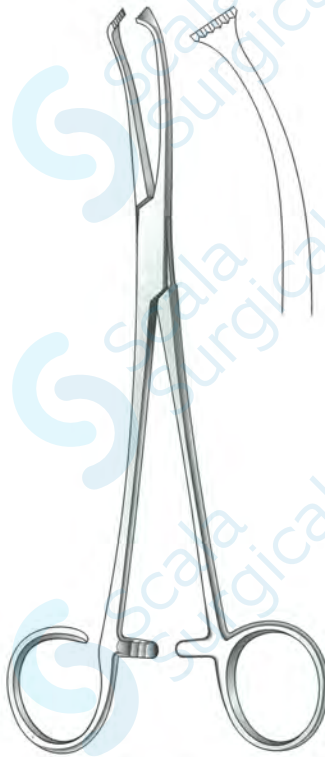

Colver
S-34-3027
7½", 19 cm
Tonsil, Vulsellum Forceps

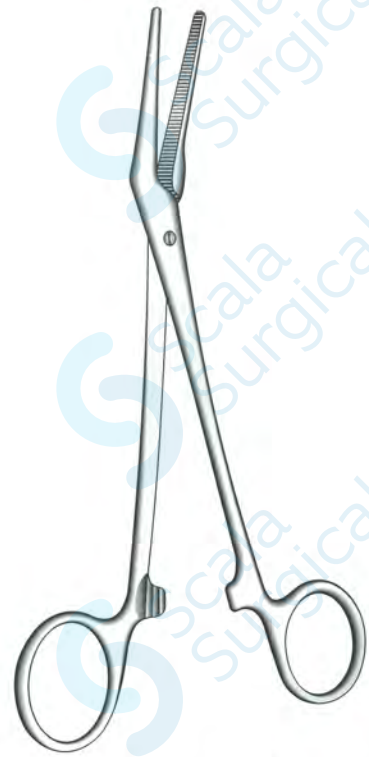

Irwin Moore
S-34-3028
7", 18 cm
Thyroid Gland Forceps



Irwin Moore

S-34-3030 Curved to Right
S-34-3031 Curved to Left
Tonsil Needles



Robin

S-34-3033 Small, 8/12 mm
S-34-3034 Medium, 10/12 mm
S-34-3035 Large, 14/18 mm
Chisel, T Shape Handle

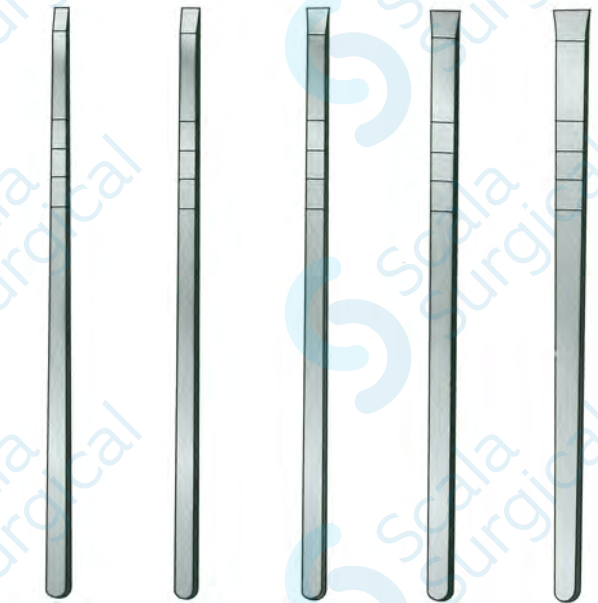

S-34-3036 5 mm No.1
S-34-3037 6 mm No.2
S-34-3038 7 mm No.3
S-34-3039 9 mm No.4
S-34-3040 11 mm No.5

Cottle

7/8", 18.5 cm
Chisel



Mc Indoe

S-34-3043 9 mm
S-34-3044 11 mm
S-34-3045 13 mm
Chisel

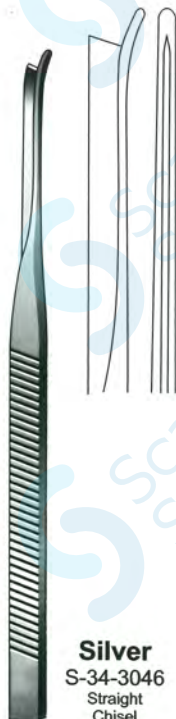

Silver

S-34-3046
Straight
Chisel



Silver

S-34-3047
Curved to Right
Chisel



Silver

S-34-3048
Curved to Left
Chisel

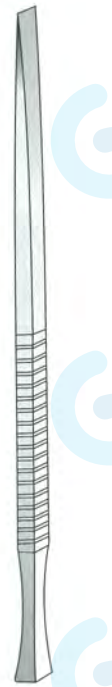
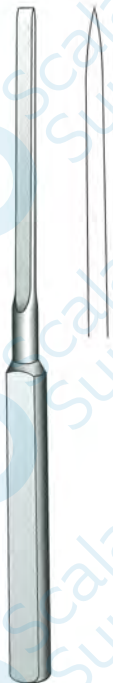
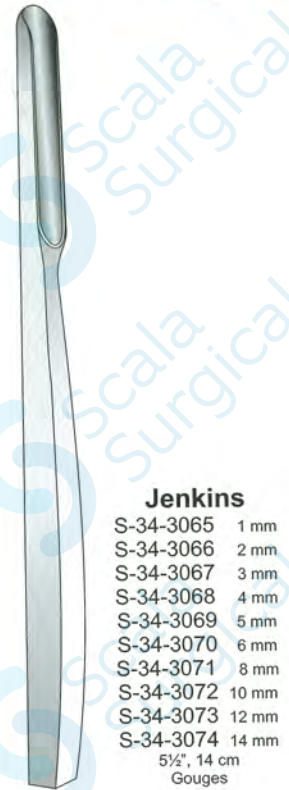



Killian
S-34-3092
5", 12.5 cm
4 mm Wide, Angled
Nasal Gouge



Tilley
S-34-3093
6", 15 cm
Angled
Nasal Gouge



Myles
S-34-3094
Perforator



Allen Osteophyte
S-34-3095
Chisel & Scraper

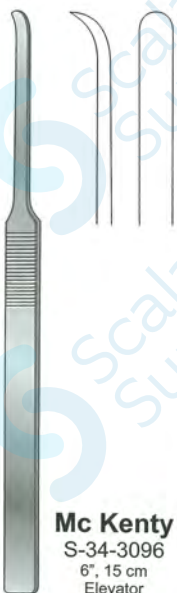

Mc Kenty
S-34-3096
6", 15 cm
Elevator



Joseph
S-34-3097
7", 18 cm
Raspatory

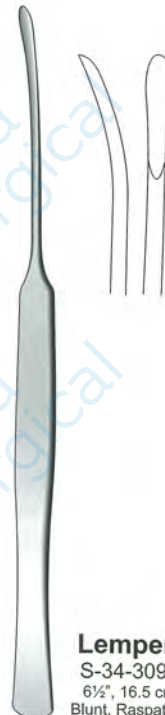

Lempert
S-34-3098
6½", 16.5 cm
Blunt, Raspatory



Lempert
S-34-3099
7¼", 18.5 cm
Semi Sharp, Raspatory

Ent Instruments

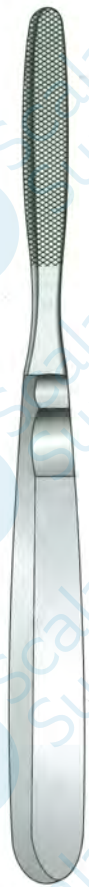

Joseph
6½", 16.5 cm
Raspatory

7.5 mm

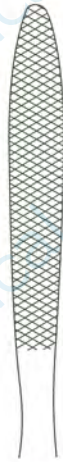

S-34-3100
Fine

9 mm



S-34-3101
Coarse



Aufricht
8¾", 22 cm
Raspatory

9 mm



S-34-3103
Upward Stroke

9 mm

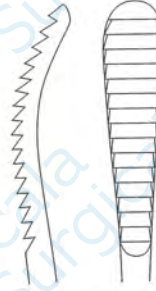

S-34-3105
Downward Stroke



Maltz

S-34-3107 Straight
S-34-3108 Curved
Nasal Raspatory



Watson-Williams

S-34-3110
6¾", 17 cm
Round with Convex Blade



Woakes
S-34-3112
Straight, Nasal Saws



Joseph
S-34-3114 Left
S-34-3115 Right
Vertical Shaft
Bayonet Crank, Nasal Saws



Joseph
S-34-3117 Left
S-34-3118 Right
5" x 3/8"
Horizontal Shaft, Nasal Saws



Mowlem Nasal Saws
S-34-3120
8", 20 cm



St.Clair Thomson
S-34-3122 Sharp
Elevators



St.Clair Thomson
S-34-3123 Blunt
Elevators

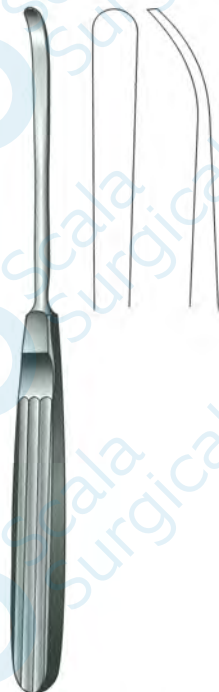

Septum Raspatory
S-34-3125
Fine, Curved



Freer Instruments
7½", 19 cm



Freer Knife
S-34-3140
Rounded Edge Blade
8 mm



Freer Knife
S-34-3141
Flat Rounded Blade



Freer Knife
S-34-3142
Rounded Blade
Curved on Flat



Freer Elevator
S-34-3143
Sharp Edge



Freer Elevator
S-34-3144
Dull Edge



Freer Elevator
S-34-3145
Curved To Side



Freer Chisel
S-34-3146
Chisel



Cleft Palate
S-34-3150 Curved Downwards
S-34-3151 Curved Upwards
Raspatory



Cleft Palate
S-34-3152
Curved Upwards
Right



Cleft Palate
S-34-3153
Curved Upwards
Left



Childe
S-35-2500
5½", 14 cm
Hernia

Key
S-35-2501
6¾", 16 cm
Hernia



Symes
S-35-2505
7¼", 18.5 cm



Watson Chyene
S-35-2506 5", 18 cm
S-35-2507 6¾", 17 cm
S-35-2508 9", 23 cm



Watson Chyene
S-35-2509
6¾", 17 cm
S-35-2510
9", 23 cm

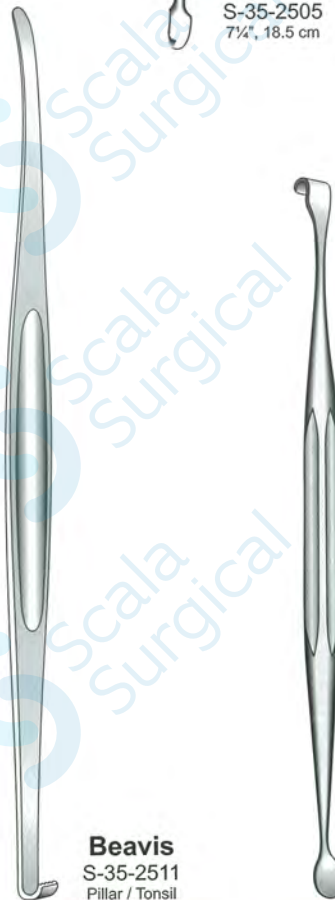

Beavis
S-35-2511
Pillar / Tonsil

Mollison
S-35-2512
Pillar / Tonsil



Hurd
S-35-2513
Pillar / Tonsil

Dissectors & Elevators



Henderson
S-35-2514
Double Ended



Durham
S-35-2515
7½", 19 cm
Double Ended



Gwynne Evans
S-35-2516 6 mm
S-35-2517 8 mm



Hill
S-35-2520
8¾", 22 cm
Double Ended
Curved to Side



Horsley
S-35-2522
9", 23 cm
Dura (Neuro)



Howarth
S-35-2524
8¾", 22 cm
One End Rugine



MacDonald
S-35-2526
Double Ended
7½", 19 cm



Mitchell
S-35-2528
Trimmer

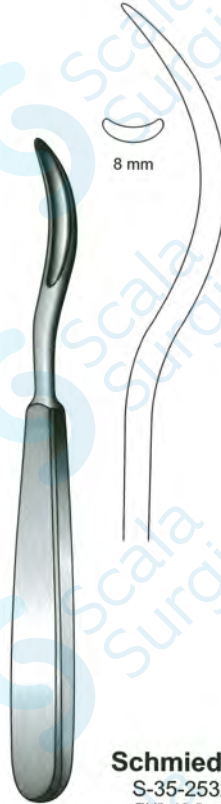

Schmieden
S-35-2532
7/8", 18.5 cm



Kocher
S-35-2533
Thyroid Dissector
with Eye



Kocher
S-35-2534
Thyroid Dissector



Kocher
S-35-2535
Thyroid Dissector
With Eye

Dissectors & Elevators

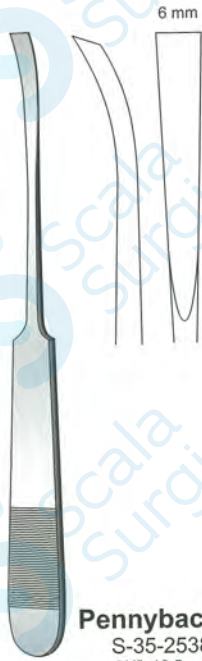

Pennybacker
S-35-2538
6½", 16.5 cm
Blunt



Pennybacker
S-35-2540
9", 23 cm
Probe Dissector



McKenty
S-35-2542
6", 15 cm



McKenty
S-35-2544
8¾", 22 cm



Freer
S-35-2546 Sharp
S-35-2547 Blunt
7½", 19 cm
Single / Ended

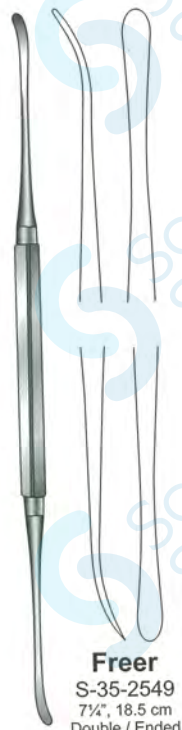

Freer
S-35-2549
7¼", 18.5 cm
Double / Ended
Sharp / Blunt



Freer-Yasargil
S-35-2551
7¼", 18.5 cm
Double / Ended
Sharp / Sharp



Swedish
S-35-2553
7", 18 cm
S-35-2554
8", 20.5 cm

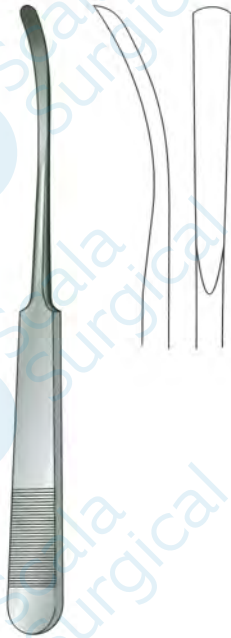

Adson

S-35-2556 5mm Straight
S-35-2557 7mm Straight
S-35-2558 Curved
S-35-2559 Curved



Adson Hollow Handle

S-35-2562 8mm Straight
S-35-2563 7mm Straight
S-35-2564 7mm Curved

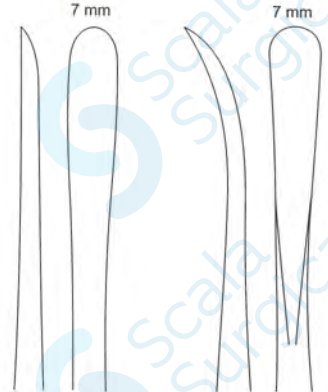

S-35-2563
7mm
Straight

S-35-2564
7mm
Curved



Williger

S-35-2568
5½", 14 cm



Williger

S-35-2569
6½", 16.5 cm

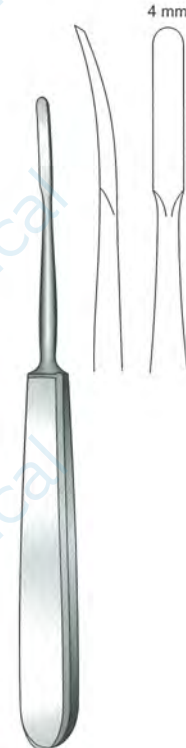

Joseph

S-35-2571
7", 18 cm



Ward

S-35-2573
6¾", 17 cm

Dissectors & Elevators

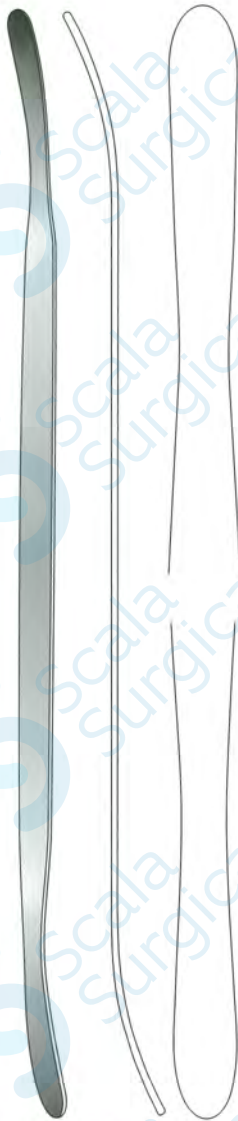

Penfield
S-35-2575
11½", 29 cm
Double Ended, Slightly Curved

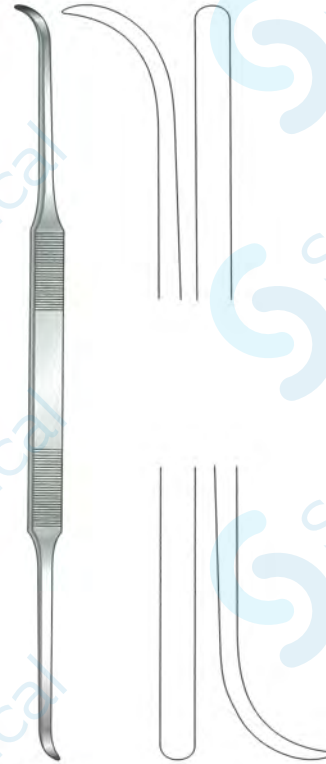

Cottle
S-35-2577
8", 20 cm
Double / Ended
Sharp / Sharp

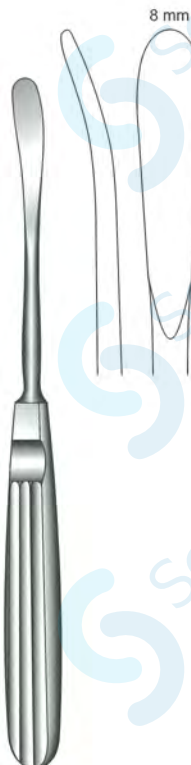

Cottle
S-35-2579
7¾", 19.5 cm

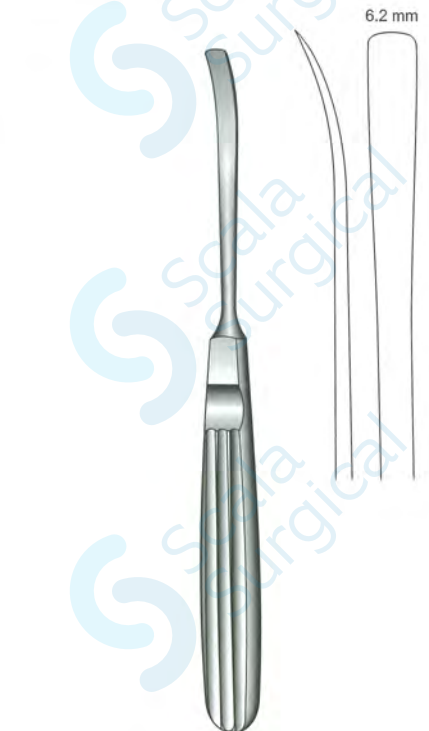

Caspar
S-35-2581
7", 18 cm

Dissectors & Elevators

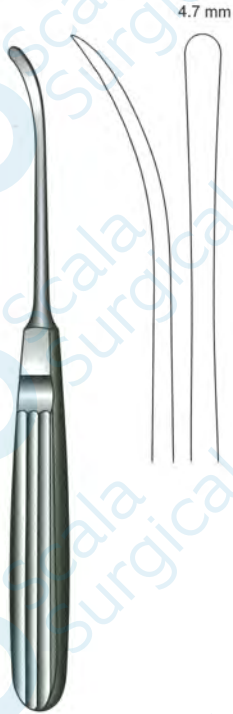

Landolt
S-35-2584
7", 18 cm



Langenbeck
S-35-2585
7½", 19 cm

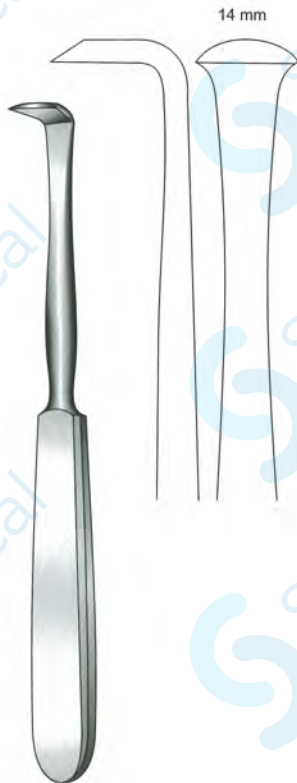

Langenbeck
S-35-2586
7", 18 cm



Mc Kisson
S-35-2588
7¾", 19.5 cm

Tissue Forceps

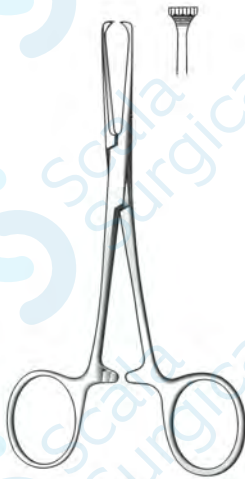

Allis

- S-36-2500 1:2 Teeth
- S-36-2502 2:3 Teeth
- S-36-2504 3:4 Teeth
- S-36-2506 4:5 Teeth
- S-36-2508 5:6 Teeth
- 6", 15 cm

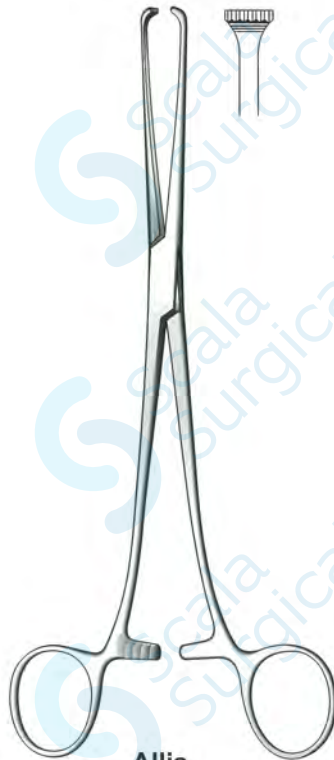

Allis

- S-36-2510 7", 18 cm
- S-36-2512 8", 20 cm
- S-36-2514 10", 25.5 cm
- 5:6 Teeth

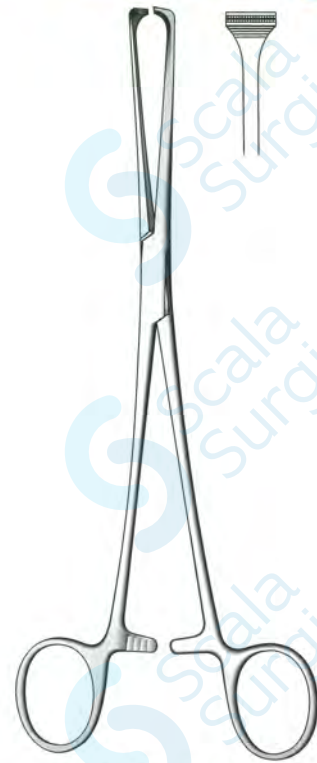

Allis-Atraumatic

- S-36-2516 6", 15 cm
- S-36-2518 8", 20 cm
- S-36-2520 8 3/4", 22 cm

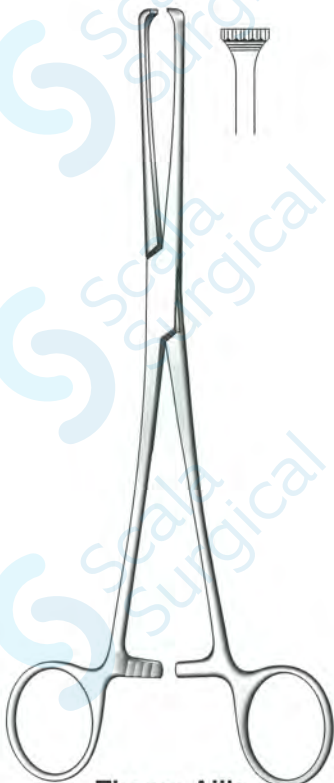

Thoms-Allis

- S-36-2524
- 8", 20 cm
- 6:7 Teeth

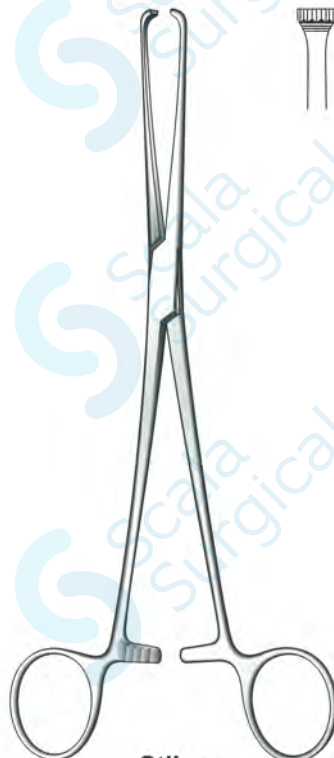

Stiles

- S-36-2526
- 8", 20 cm
- 6:7 Teeth

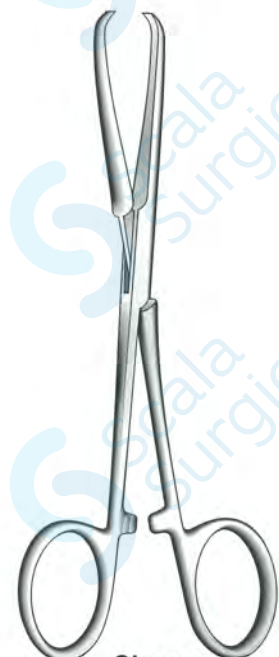

Shaw

- S-36-2528
- 5", 13 cm
- 1:2 Teeth

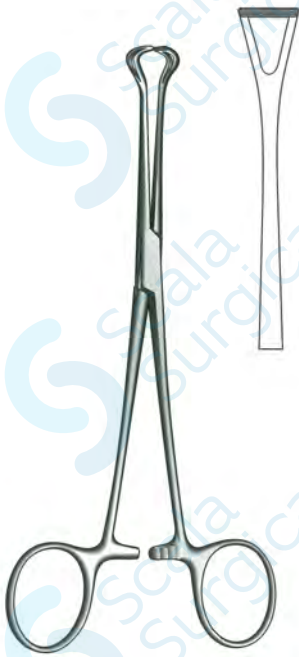

Babcock

- S-36-2540 6½", 16 cm
- S-36-2542 7", 18 cm
- S-36-2544 8", 20 cm
- S-36-2546 9", 23 cm
- S-36-2548 10", 25.5 cm
- S-36-2550 12", 30.5 cm

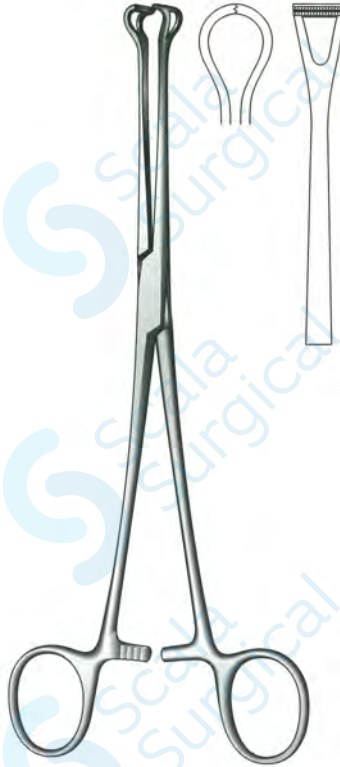

Babcock-Atraumatic

- S-36-2556 6½", 16 cm
- S-36-2558 8", 20 cm
- S-36-2560 9", 23 cm



Babcock

- S-36-2564 6½", 16 cm
 - S-36-2566 8", 20 cm
- Tungsten Carbide

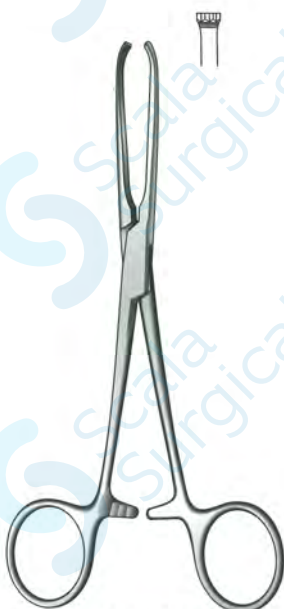

Judd-Allis

- S-36-2568 6", 15 cm
- S-36-2570 7½", 19 cm

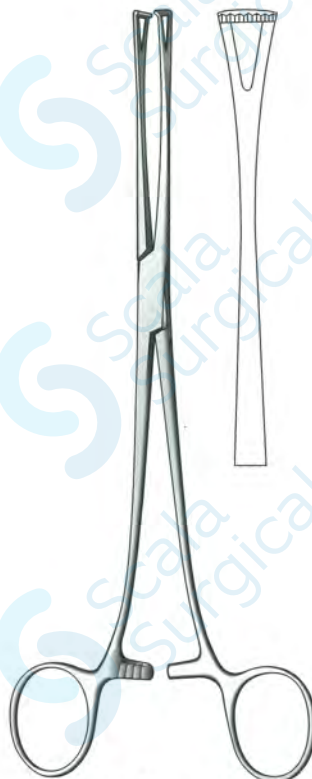

Lockwood

- S-36-2572 8", 20 cm

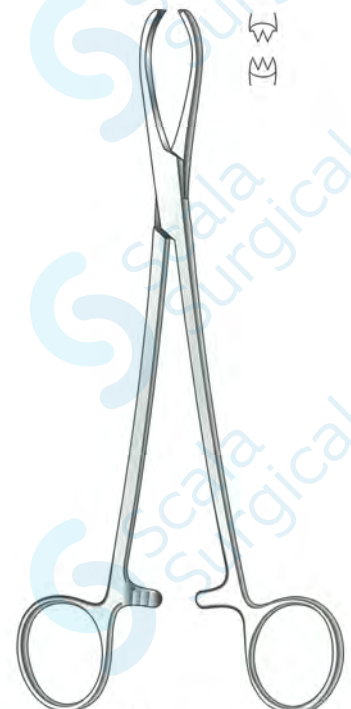

Littlewood

- S-36-2574 7½", 19 cm
 - S-36-2576 8", 20 cm
 - S-36-2578 10", 25.5 cm
- 2:3 Teeth

Tissue Forceps



Lanes

S-36-2580 5", 13 cm
 S-36-2582 6", 15 cm
 S-36-2583 7 $\frac{3}{4}$ ", 19.5 cm
 S-36-2584 8", 20 cm
 1:2 Teeth, Fenestrated

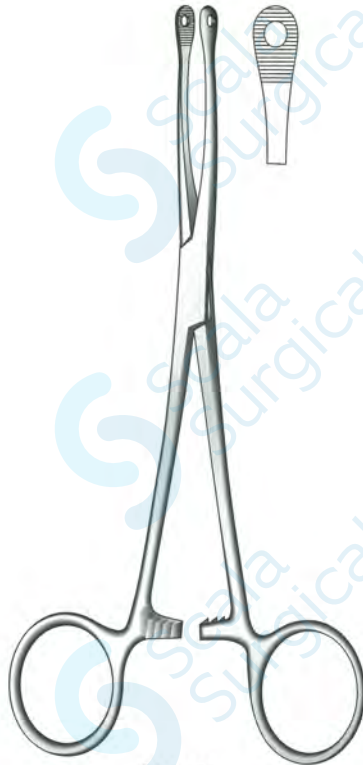

Percy

S-36-2585
 9 $\frac{1}{4}$ ", 24 cm

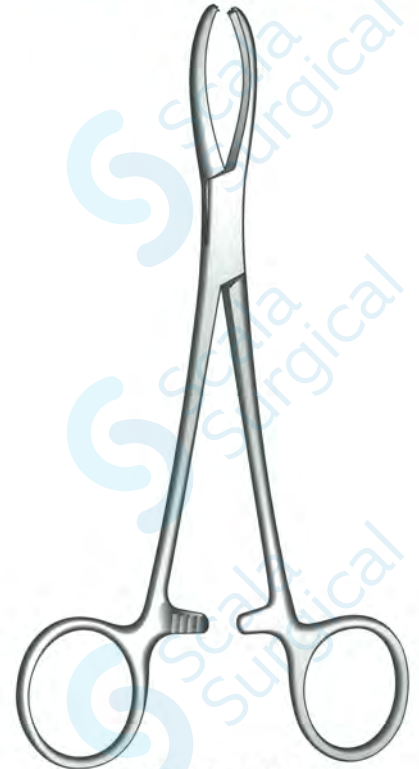

Rutherford Morrison

S-36-2587
 6 $\frac{1}{2}$ ", 16 cm
 4:5 Teeth

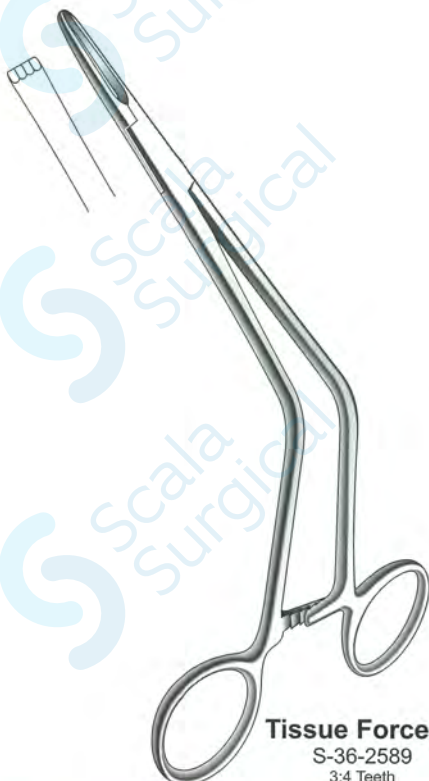

Tissue Forceps

S-36-2589
 3:4 Teeth
 7", 20 cm
 Angled Shanks



Chaput

S-36-2591
 5", 13 cm
 3:4 Teeth, Sharp

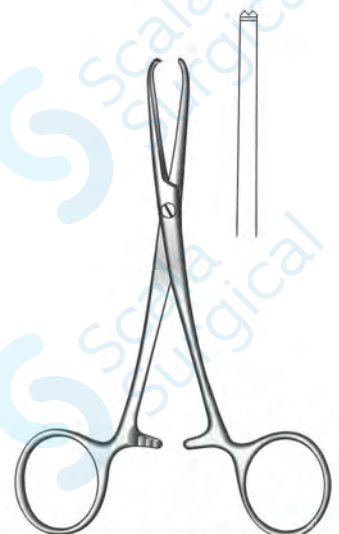

Poirier

S-36-2593
 5", 13 cm
 2:3 Teeth

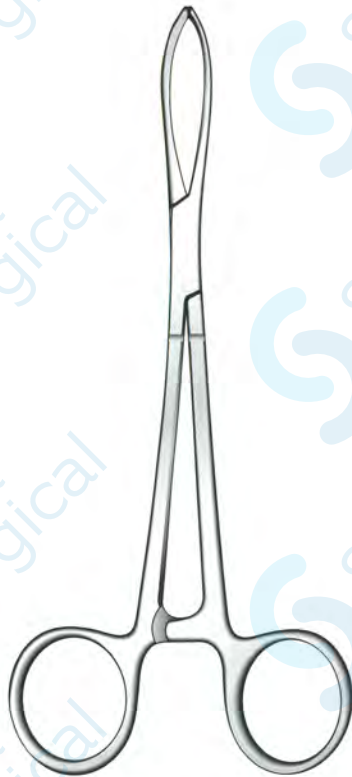

S-36-2601
1:2 Teeth
Vasectomy Forceps

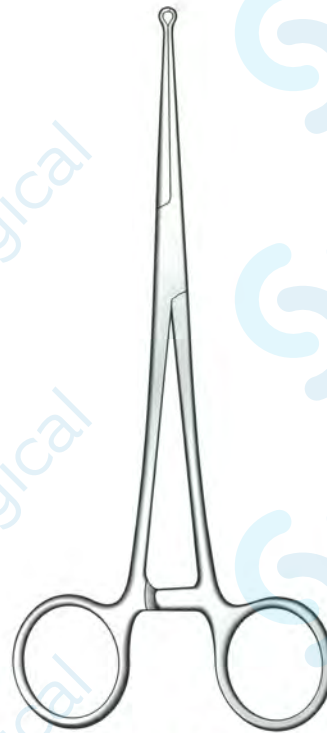

Craft
S-36-2603
Vasectomy Forceps

Tissue Forceps

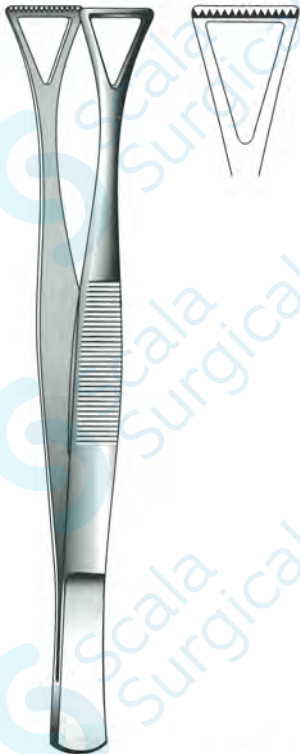

Duval
S-36-2710
8", 20 cm
Spring Pattern, 13 mm Jaws

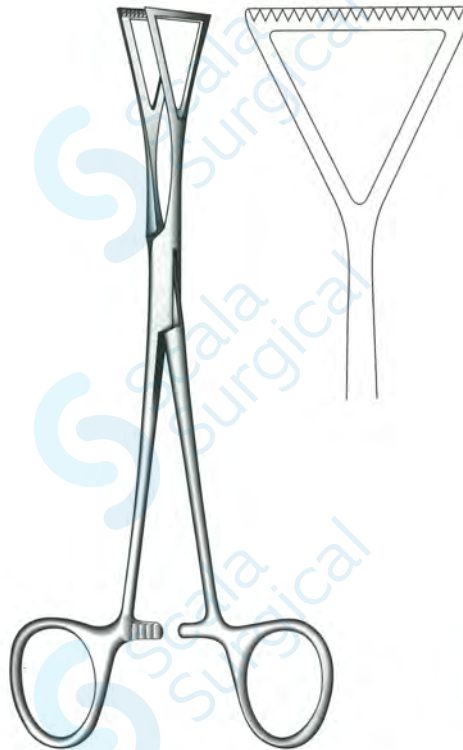

Duval
S-36-2715 1/2" Jaw, 7", 18 cm
S-36-2717 1/2" Jaw, 8", 20 cm
S-36-2718 3/4" Jaw, 8", 20 cm
S-36-2719 1" Jaw, 8", 20 cm
S-36-2720 1" Jaw, 9", 23 cm

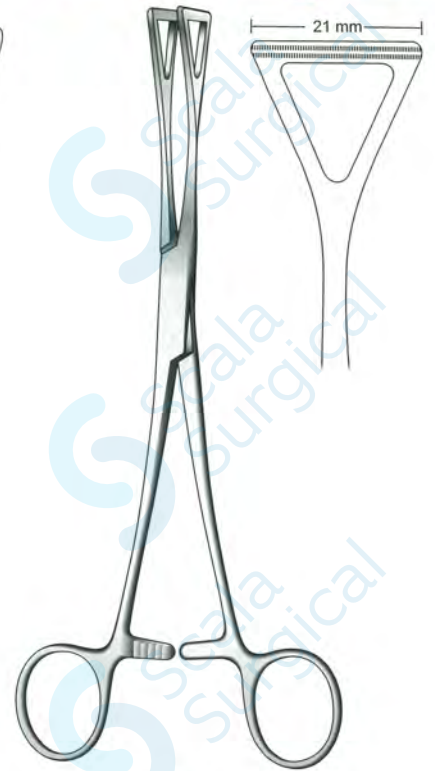

Duval
S-36-2725 8", 20 cm
S-36-2727 9", 23 cm
Atraumatic Jaws

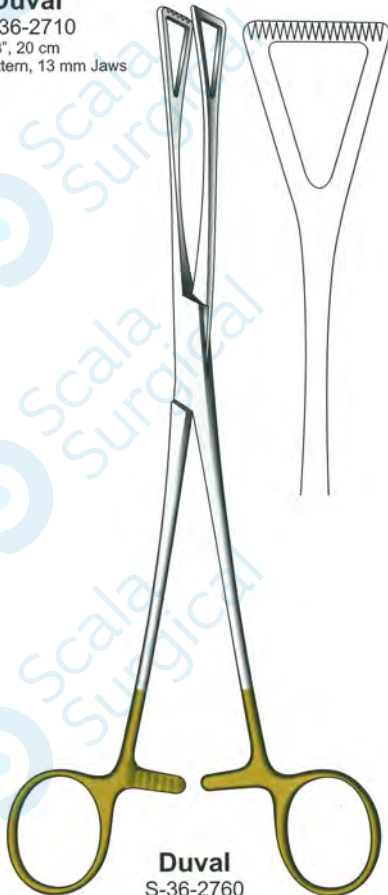

Duval
S-36-2760
8", 20 cm
3/4" Jaw
Tungsten Carbide

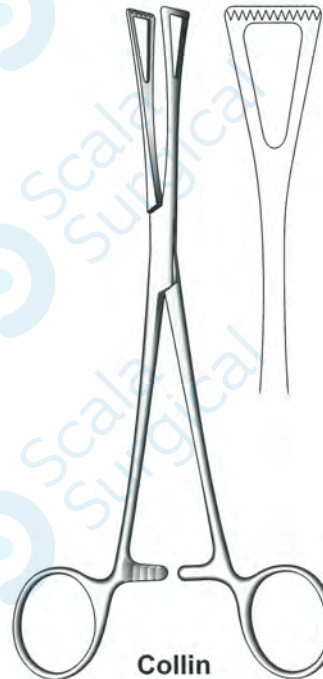

Collin
S-36-2765
7", 18 cm

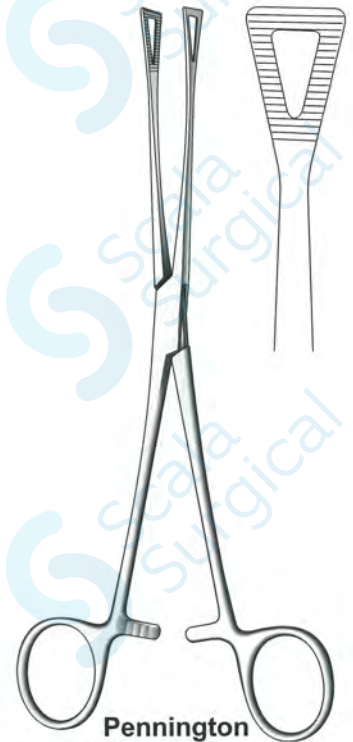

Pennington
S-36-2767 6", 15 cm
S-36-2769 8", 20 cm



Price Thomas

- S-36-2812 Serrated Jaws with out Teeth
 - S-36-2813 Serrated Jaws with Teeth in Right Jaws
 - S-36-2814 Serrated Jaws with Teeth in Left Jaws
- 9½", 22 cm
Box Joint

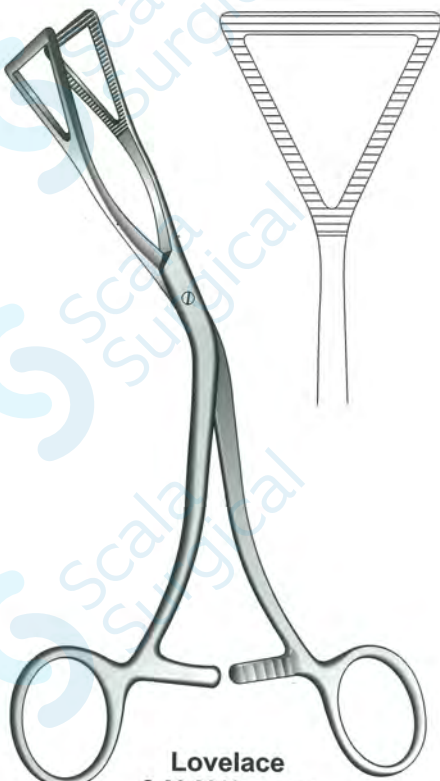

Lovelace

- S-36-2816 Straight
 - S-36-2820 Angled
- 8", 20 cm
Screw Joints, 28 mm Jaws

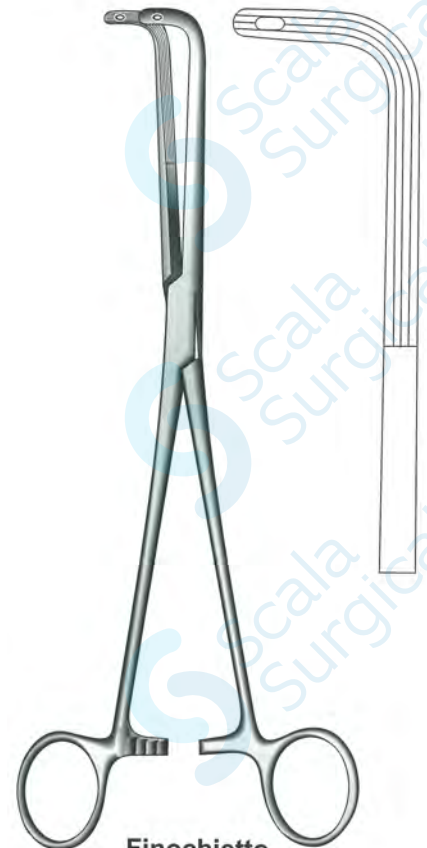

Finochietto

- S-36-2822
- 9½", 24 cm
Box Joint, Curved

Intestinal Clamps

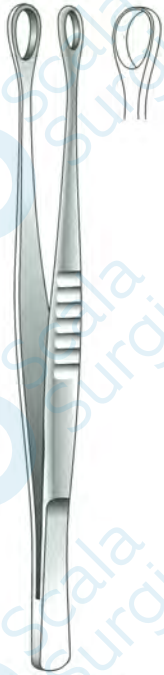

Denis Browne
S-40-2500
7", 18 cm .
Spring Pattern



Denis Browne
S-40-2501
5½", 14cm
Box Joint, Pylorus

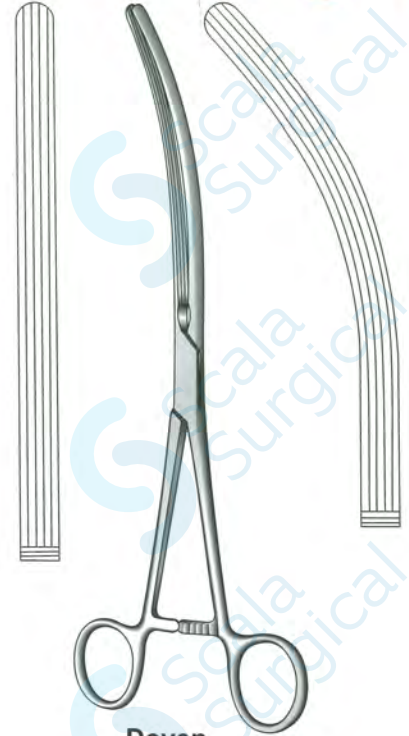

Doyen
Blade 4", Longitudinal Serration
S-40-2502 S-40-2503 Box Joint, 7", 18 cm
S-40-2504 S-40-2505 Screw Joint, 9", 23 cm
S-40-2506 S-40-2507 Box Joint, 9", 23 cm
Straight Curved

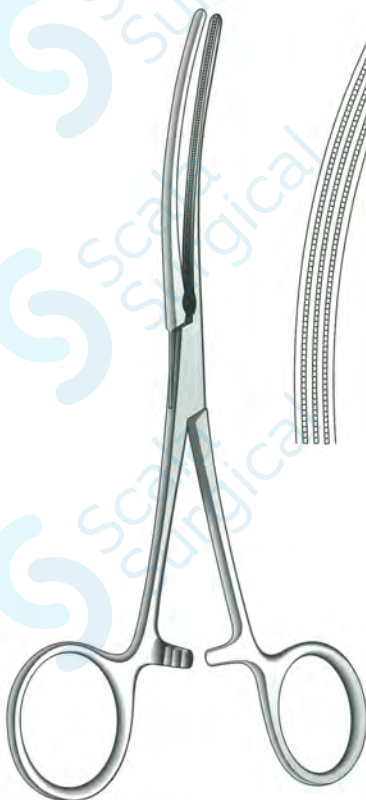

Doyen
Atraumatic Jaws
S-40-2510 Straight S-40-2512
S-40-2511 Curved S-40-2513
7", 18 cm 9", 23 cm

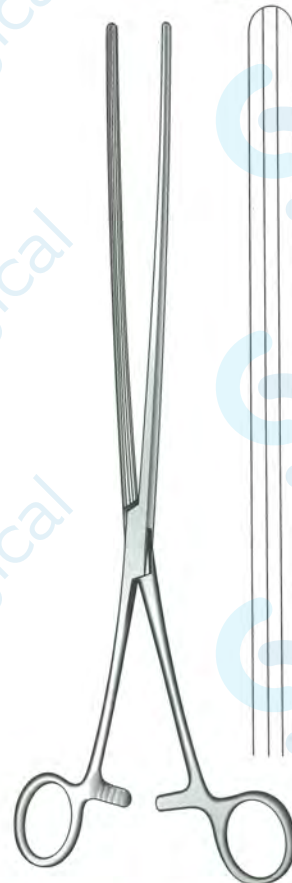

Kocher
S-40-2515 4" Blade 9", 23 cm
S-40-2516 5" Blade 10", 25.5 cm
S-40-2517 5" Blade 11", 28 cm
Straight

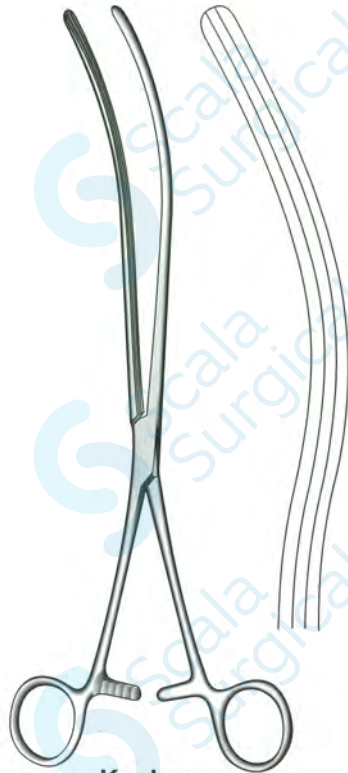

Kocher

S-40-2518 4" Blade, 9", 23 cm
 S-40-2519 5" Blade, 10", 25.5 cm
 S-40-2520 5" Blade, 11", 28 cm
 Curved

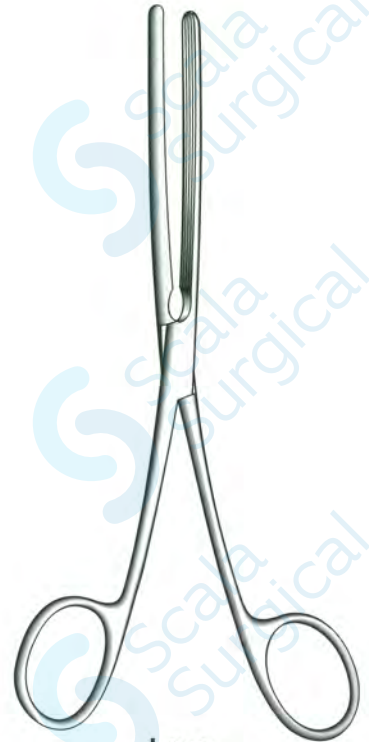

Lane

S-40-2521 Straight S-40-2523
 S-40-2522 Curved S-40-2524
 3" Blade 4" Blade
 8½", 21.5 cm

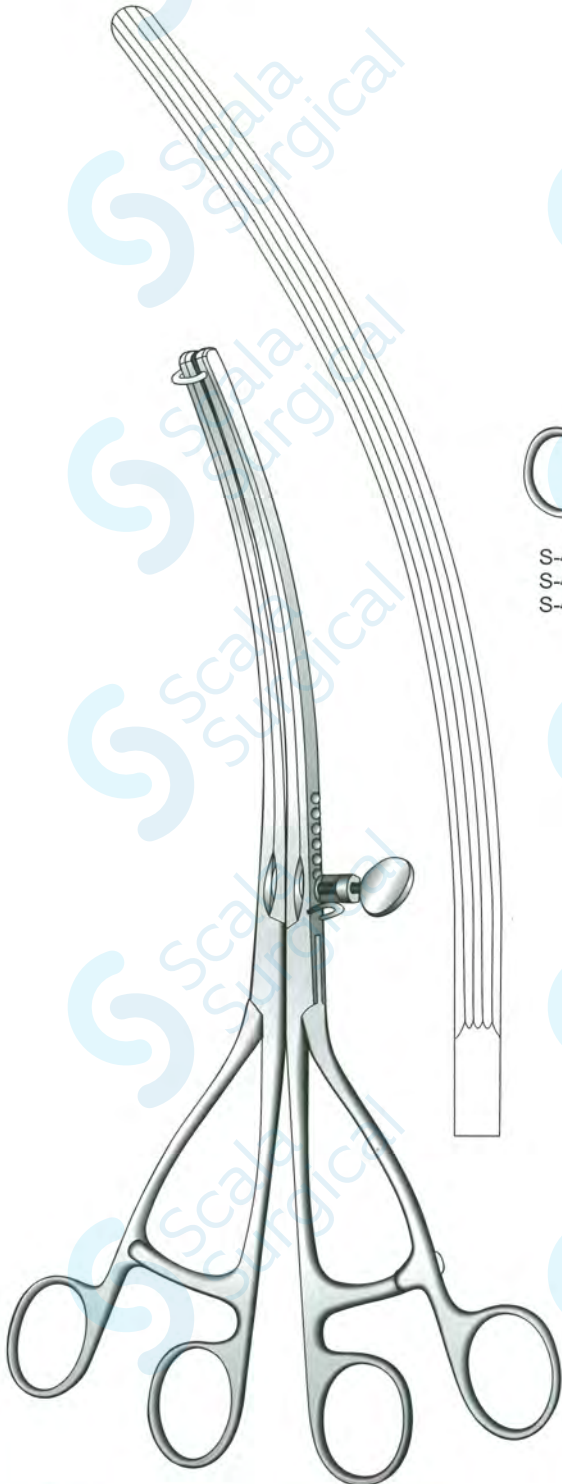

Lane (Twin)

S-40-2526 Straight
 S-40-2527 Curved
 12", 30.5 cm
 5½" Blade

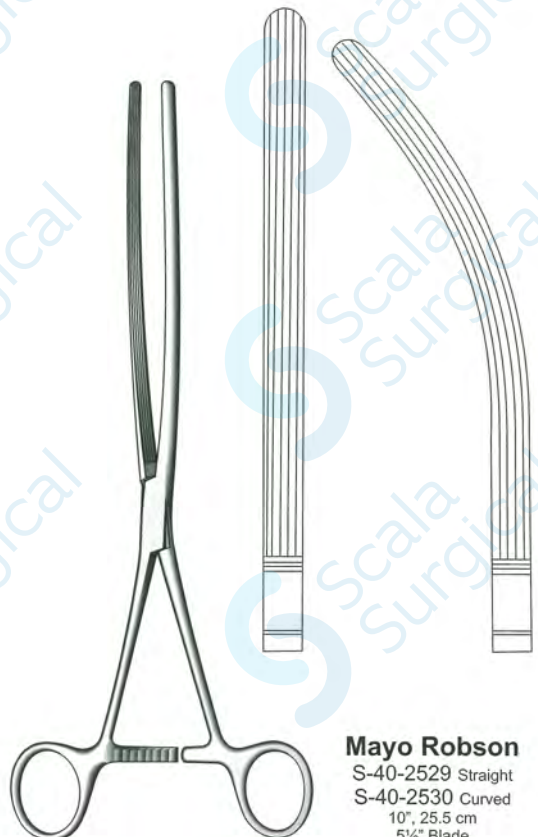

Mayo Robson

S-40-2529 Straight
 S-40-2530 Curved
 10", 25.5 cm
 5½" Blade

Intestinal Clamps

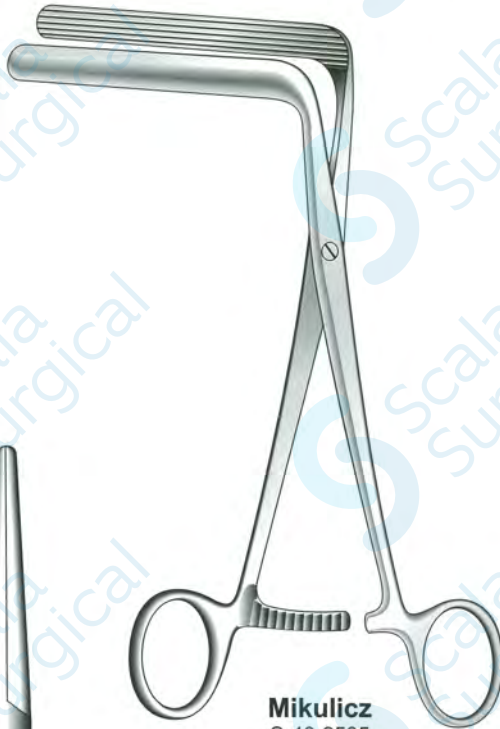

Mikulicz
S-40-2535
90° Angled Blades
7½", 19cm

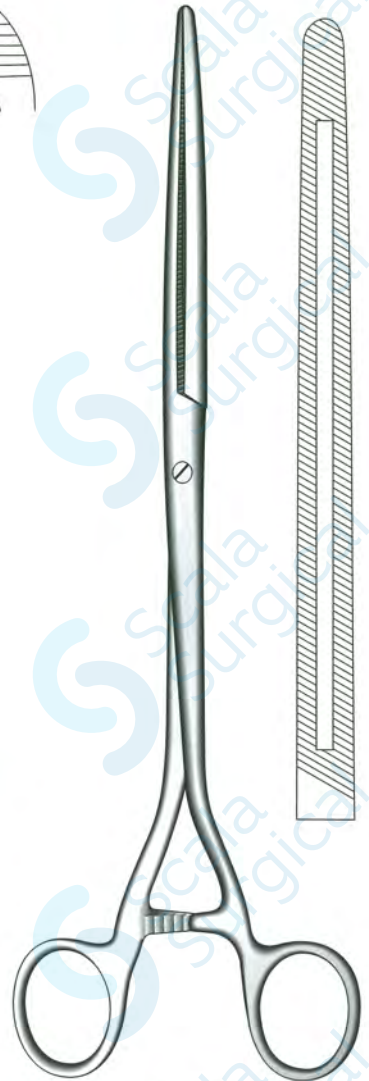

Moynihan
S-40-2536
¾" Fenestrated Blades
10", 25.5 cm

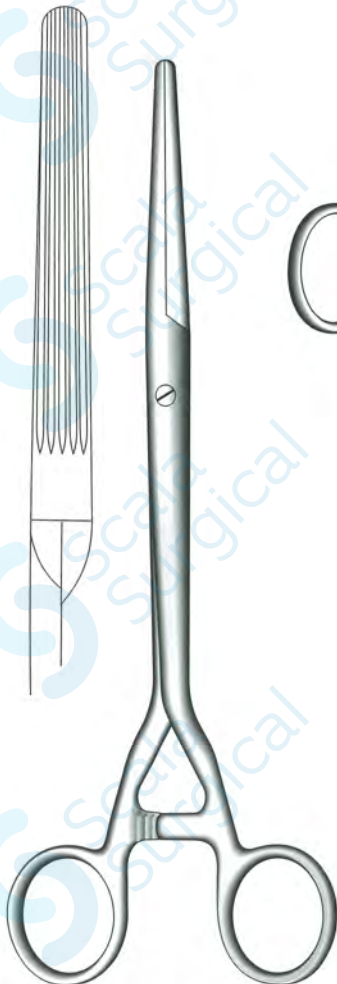

Parker-Kerr
S-40-2537 Straight Jaws S-40-2539
S-40-2538 Curved Jaws S-40-2540
9", 23 cm 10", 25.5 cm
Screw Joint

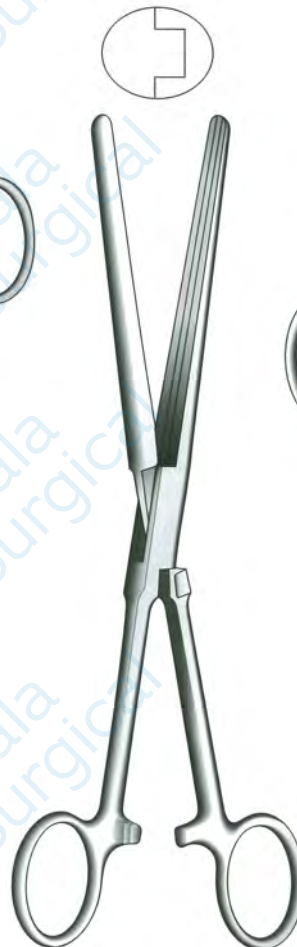

Lange Stevenson
S-40-2542
8", 20 cm
Keyed Blades
80mm Blades

Intestinal Clamps

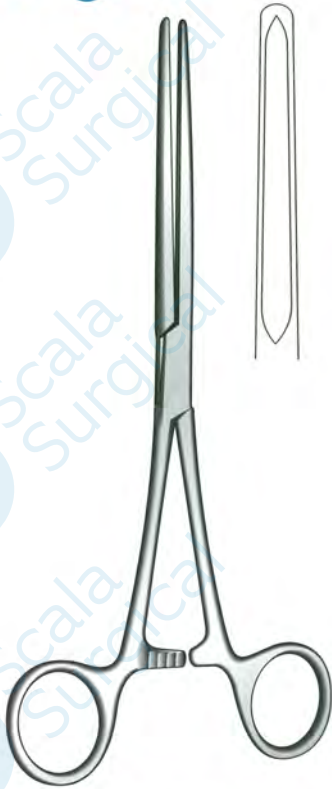

Schoemaker
S-40-2550
6½", 16 cm
Fine Grooved Blades



Seton Pringle
S-40-2552
6½", 16 cm
2½", 6.5 cm blade

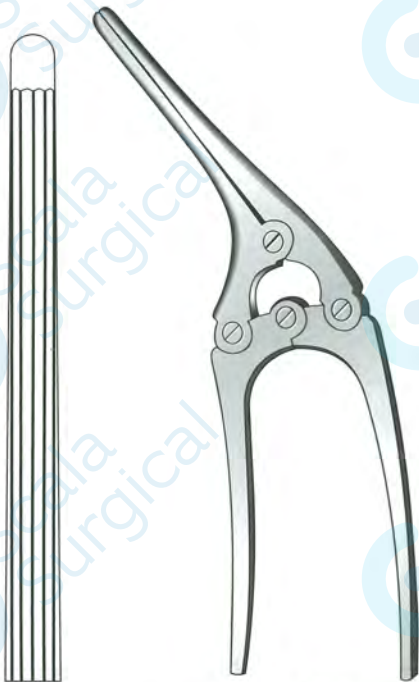

Payr
S-40-2555 2½" Blades, 6", 15 cm
S-40-2556 3" Blades, 8¼", 21 cm
S-40-2557 4" Blades, 11½", 29 cm
S-40-2558 5" Blades, 13¼", 33.5 cm
Without Pin

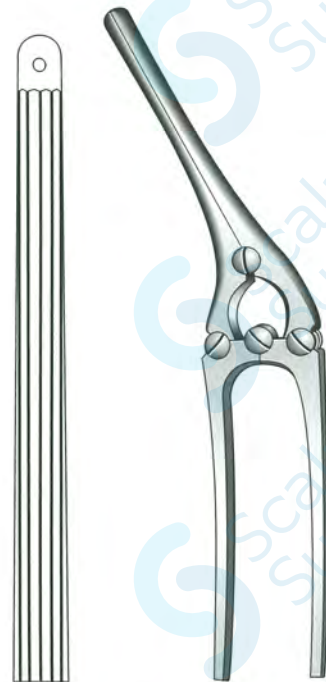

Payr
S-40-2560 2½" Blades 6", 15 cm
S-40-2561 3" Blades 8¼", 21 cm
S-40-2562 4" Blades 11½", 29 cm
S-40-2563 5" Blades 13¼", 33.5 cm
With Pin

Cholecystectomy Forceps

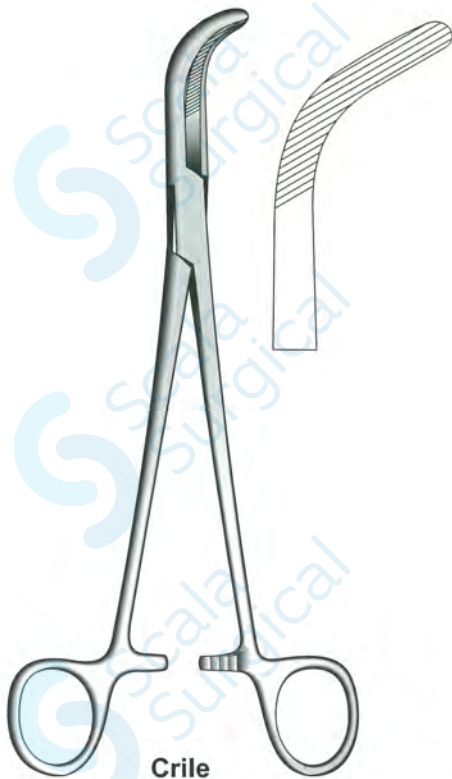

Crile
S-40-2567
Box Joint, Curved
8", 20 cm

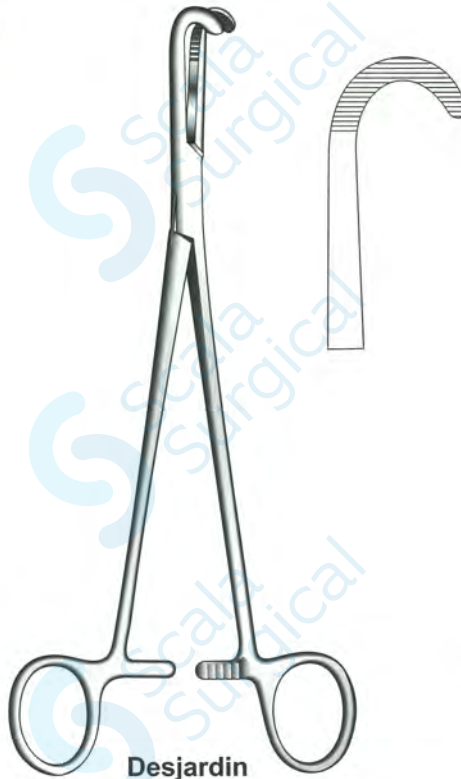

Desjardin
S-40-2568
Box Joint, Full Curved
8½", 21.5 cm

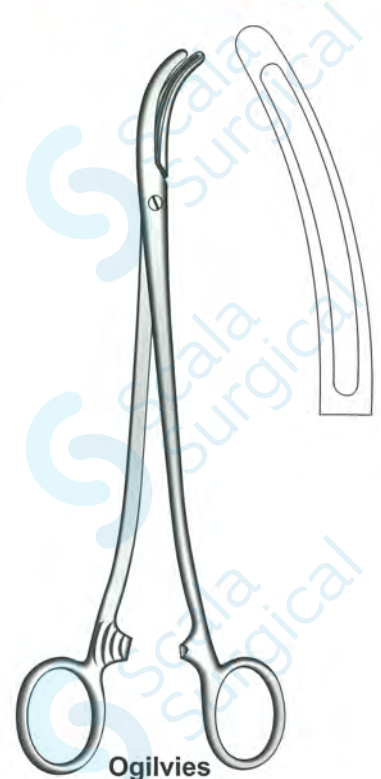

Ogilvie
S-40-2569
9", 23 cm
Screw Joint, Trap Jaws



Geary Grant
S-40-2570 Small Curve
S-40-2571 Large Curve
Longitudinal Serration
S-40-2572 Small Curve 1:2
S-40-2573 Large Curve 1:2
9", 23 cm
Screw Joint

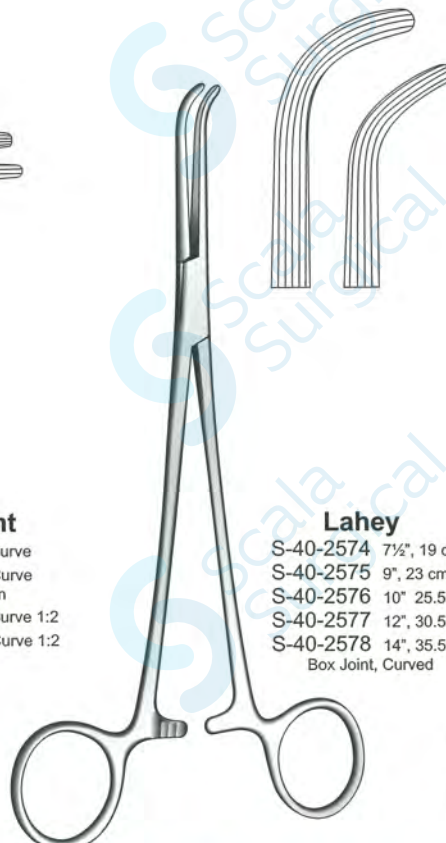

Lahey
S-40-2574 7½", 19 cm
S-40-2575 9", 23 cm
S-40-2576 10" 25.5 cm
S-40-2577 12", 30.5 cm
S-40-2578 14", 35.5 cm
Box Joint, Curved

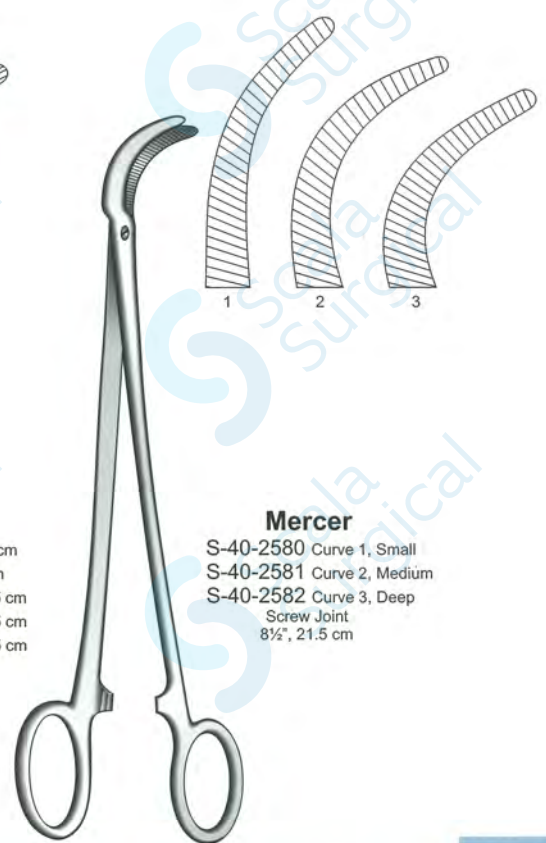

Mercer
S-40-2580 Curve 1, Small
S-40-2581 Curve 2, Medium
S-40-2582 Curve 3, Deep
Screw Joint
8½", 21.5 cm

Cholecystectomy Forceps



S-40-2583 8¾", 22 cm
S-40-2584 10", 25.5 cm
S-40-2585 11½", 29 cm

Mixer

Mixer O Shaughnessy

S-40-2586
7½", 19 cm

Moynihan

S-40-2588 Screw Joint
S-40-2589 Box Joint
9", 23 cm

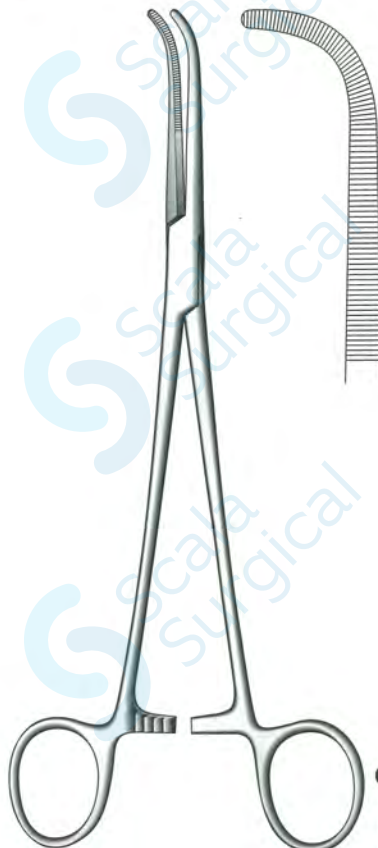

O Shaughnessy

S-40-2590 8", 20 cm
S-40-2591 9", 23 cm
S-40-2592 10", 25.5 cm
Box Joint, Curved

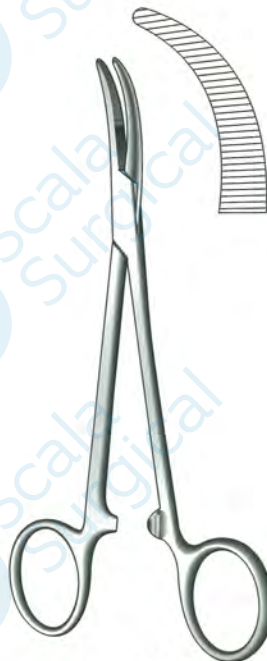

Turner-Warwick

S-40-2594
8", 20 cm
Screw Joint, Curved

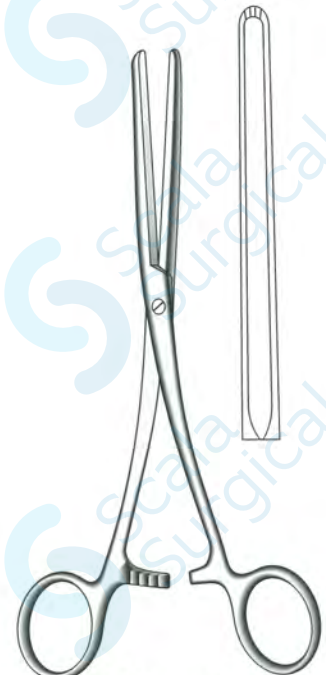

Schoemaker

S-40-2598
8½", 21.5 cm
Box Joint

Cholecystectomy Forceps

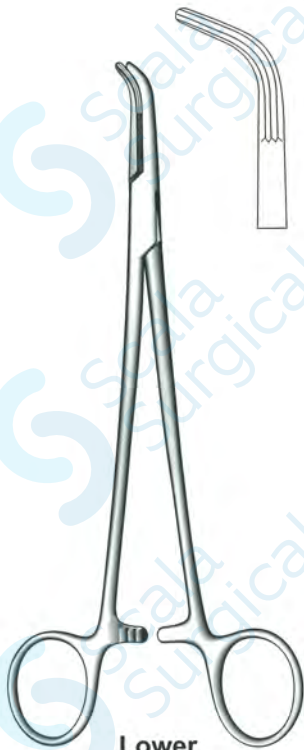

Lower
S-40-2601
7", 18 cm



Gray

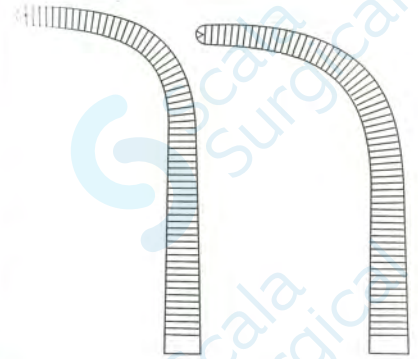

S-40-2610
Small Curved

S-40-2612
Deep Curved



Mikulicz
S-40-2616
9 3/4", 24.5 cm
Screw Joint

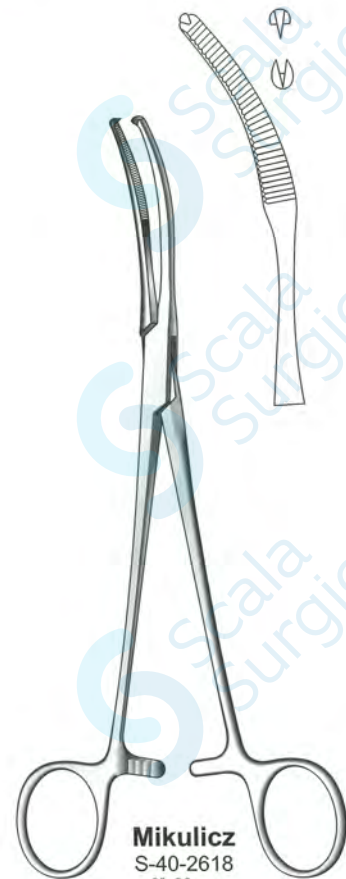

Mikulicz
S-40-2618
8", 20 cm
Box Joint



Adson

- S-41-2500 7 FG
- S-41-2501 8 FG
- S-41-2502 9 FG

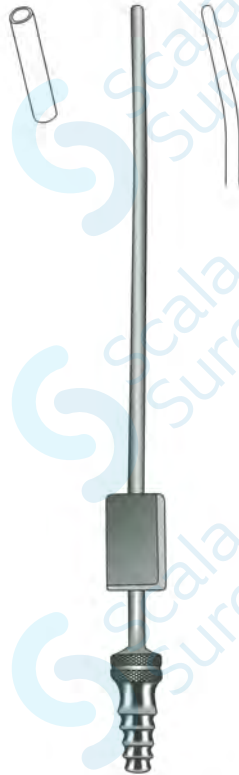

American Pattern

- S-41-2504 7 FG
- S-41-2505 8 FG
- S-41-2506 9 FG



Bierer (Intra-Uterine)

- S-41-2507 8 mm
- S-41-2508 10 mm
- S-41-2509 12 mm
- S-41-2510 14 mm



Barron (Schuhknecht)

- S-41-2511 5 FG
 - S-41-2512 6 FG
 - S-41-2513 8 FG
 - S-41-2514 10 FG
 - S-41-2515 12 FG
- 140 mm



House

- S-41-2519 16 x 18 SWG
 - S-41-2520 18 x 20 SWG
 - S-41-2521 20 x 22 SWG
- 5", 13 cm

Suction Tubes



Frazier (Adson)
 S-41-2523 8 FG
 S-41-2524 9 FG
 S-41-2525 10 FG

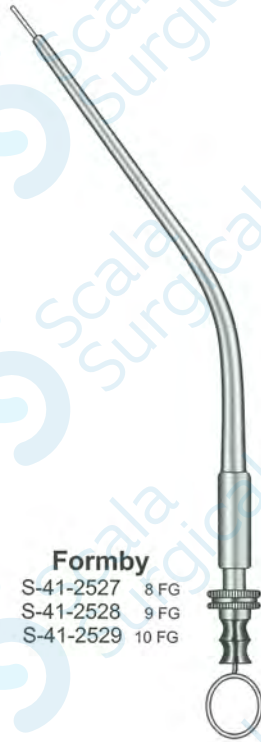

Formby
 S-41-2527 8 FG
 S-41-2528 9 FG
 S-41-2529 10 FG



Lempert
 S-41-2532 6 FG
 S-41-2533 7 FG
 S-41-2534 8 FG
 S-41-2535 9 FG
 S-41-2536 10 FG
 S-41-2537 11 FG
 S-41-2538 12 FG



Magill
 S-41-2540 Small, 3 mm
 S-41-2541 Medium, 3.5 mm
 S-41-2542 Large, 4 mm

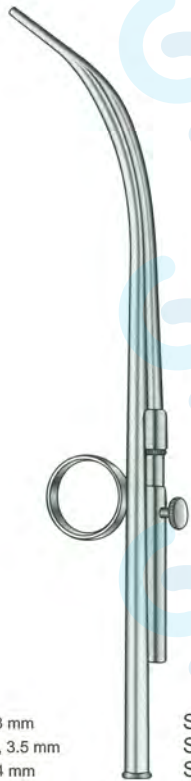

Magill
 S-41-2544 Small, 1.5 mm
 S-41-2545 Medium, 2 mm
 S-41-2546 Large, 3 mm
 Self Clearing



Poole
 S-41-2548
 Straight
 30 FG



Poole
 S-41-2549
 Curved
 30 FG

Suction Tubes



Simpson Smith
S-41-2552
Tinckler Modification
Off / On Switch



Bellucci
S-41-2554
7 mm



Kilner
S-41-2556
7 1/2", 19 cm
Suction Tube



Universal

- S-41-2558 Set of 5 Tubes
- S-41-2559 Tube A
- S-41-2560 Tube B
- S-41-2561 Tube C
- S-41-2562 Tube D
- S-41-2563 Tube E

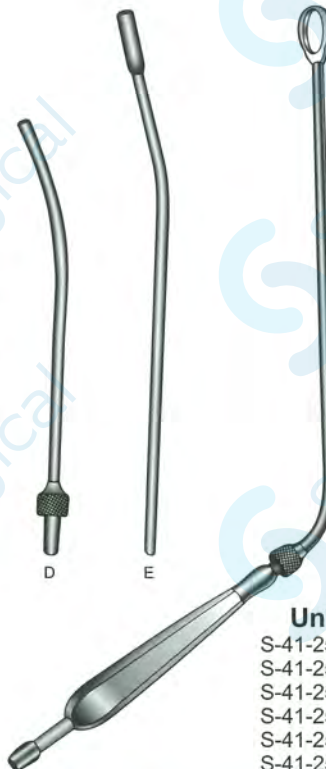

Yankauer

- S-41-2564 Chrome Plated
- S-41-2565 Stainless Steel
- S-41-2566 Rose end Only



Suction Tubes

3.0 mm



Gillies

S-41-2570

6 $\frac{1}{4}$ ", 17 cm

With Finger Cut-Off & Stylet
3.0 mm \varnothing



Rowbotham

S-41-2571

11 $\frac{3}{4}$ ", 29.5 cm

With Stylet



Zoellner

S-41-2574 18 SWG

S-41-2575 20 SWG

S-41-2576 22 SWG

S-41-2577 24 SWG

S-41-2578 26 SWG

Suction Tubes

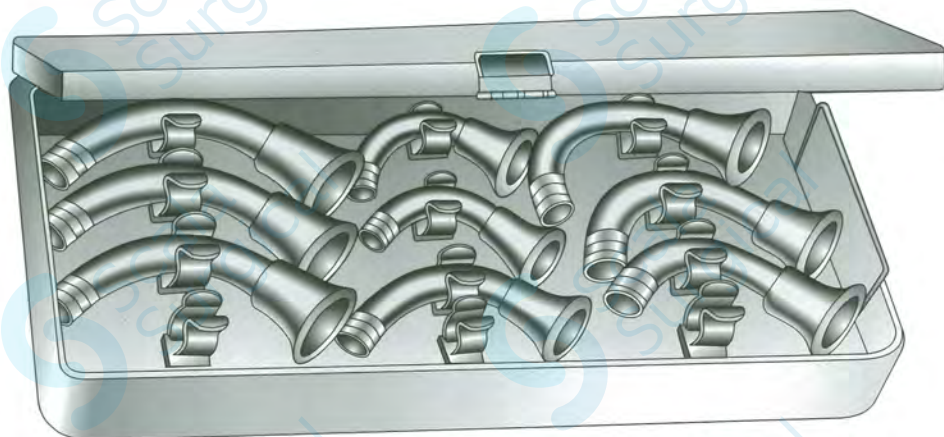

Magill Endo Tracheal Unions

S-41-2580	Set of 12
S-41-2583-1	Size 1
S-41-2583-2	Size 2
S-41-2583-3	Size 3
S-41-2583-4	Size 4
S-41-2583-5	Size 5
S-41-2583-6	Size 6
S-41-2585-7	Size 7
S-41-2585-8	Size 8
S-41-2585-9	Size 9
S-41-2585-10	Size 10
S-41-2585-11	Size 11
S-41-2585-12	Size 12

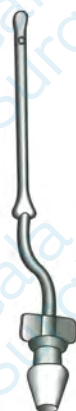

Hamilton Bailey

S-41-2589 Adult
S-41-2590 Child
Cannula, Gold Plated



Watson William

S-41-2592
Cannula, Silver Plated



Rose (Entrum)

S-41-2594
With Plug Mount, Silver Plated

Trocars

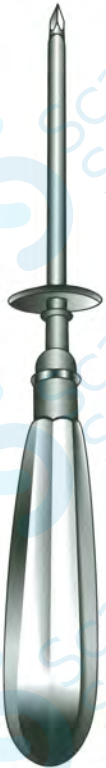

Ascites
 S-42-2500 16 FG
 S-42-2501 21 FG

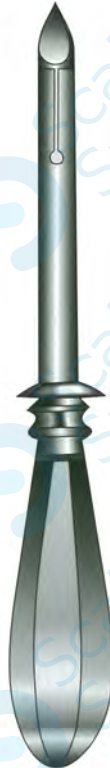

De-pezzier
 S-42-2503 25 FG
 S-42-2504 30 FG
 S-42-2505 35 FG

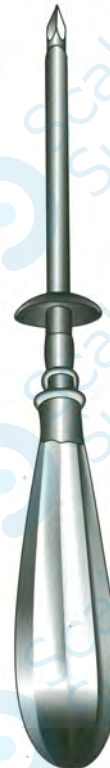

Hydrocele
 S-42-2507 8 FG
 S-42-2508 9 FG
 S-42-2509 10 FG

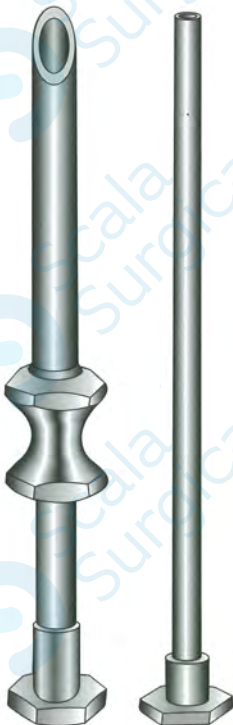

Hormone-Implant
 S-42-2511
 Trocar & Cannula

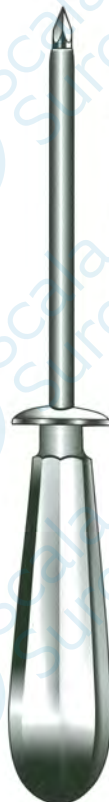

Hormone-Implant
 S-42-2512
 Trocar & Cannula
 with Hollow Handle

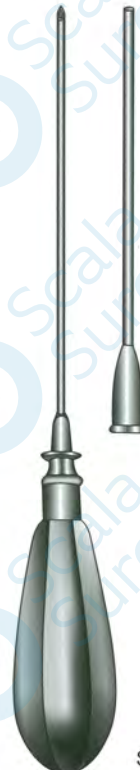

Lichtwitz
 S-42-2513 6 FG
 S-42-2514 7.5 FG
 S-42-2515 9 FG



Nelson

- S-42-2517 22 FG
- S-42-2518 25 FG
- S-42-2519 30 FG
- S-42-2520 32 FG
- S-42-2521 35 FG



Ochsner

- S-42-2524 4 mm
- S-42-2525 4.6 mm
- S-42-2526 5.3 mm
- S-42-2527 6 mm



**Tilley Harpoon
Trocar**

- S-42-2529
6 3/4", 17 cm



Abrams Needles

- S-42-2530



Universal

- S-42-2532 Set of 3 Nested
 - S-42-2533 Set of 4 Nested
- Pear Shape Handle

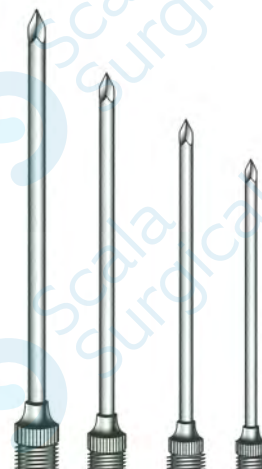

Universal

- S-42-2535 Set of 3 Nested
 - S-42-2536 Set of 4 Nested
- Round Handle