

## COYOTE<sup>®</sup> In-Line RUNT Closure

The **COYOTE In-Line RUNT Closure** has the versatility to be used in both distribution and fiber-to-the-premise (FTTP) networks for in-line or butt applications. The compact size allows for placement in small handholes and pedestals.

### Features and Benefits

- Internal organizer manages buffer tube or ribbon
- Multiple splice tray designs support mass fusion splicing, single fusion splicing or a combination of both
- Flexible grommet sealing technology supports a wide range of flat and round cable profiles
- Factory-installed gasket allows re-entry and re-use
- Flame-retardant kits available
- Designed and tested in accordance to Telcordia<sup>®</sup> GR-771-CORE Buried, Underground, IP-68 Rated Requirement

## External Features

The hinged cover allows for quick, easy access to the closure interior; no special tools required. A durable factory installed sealing material is installed on each end plate cap and cover to simplify assembly and allow reuse. The flexible, single and multi-hole COYOTE® Silicone Grommets provide a secure seal around a variety of cable profiles and eliminates the need for scuffing, adhesives, or sealing tapes.

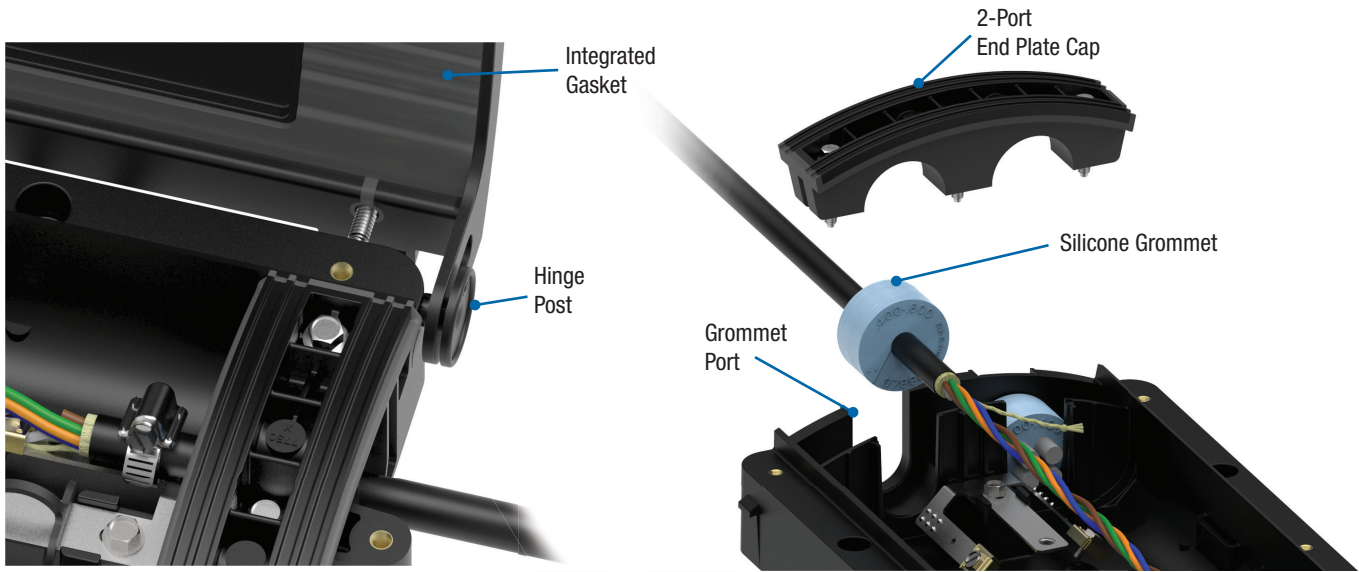

## Internal Features

The standard LITE-GRIP® Splice Tray is supplied with felt tape, splice blocks, and LITE-GRIP retention sleeves. If your application involves ribbon cable, a fiber organizer kit can be ordered separately to enhance the ribbon storage area. Factory installed cable restraint hardware is designed to provide proper pull-out strength and restricts strength member pistoning inside the closure.

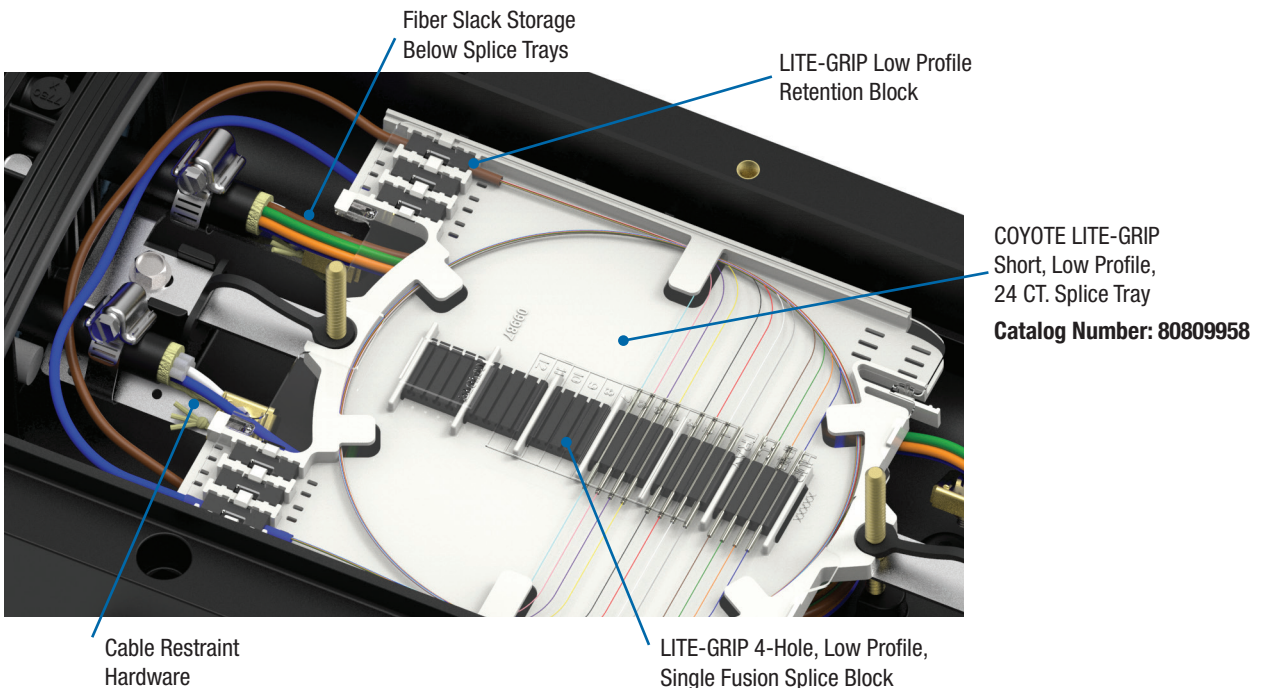

### Specifications

<b>Catalog Numbers</b>	<b>8006951, 8006952, 80061049</b>
Splice Capacity (Maximum) – Single Fusion (Low Profile, 80809958), Single Fusion (Low Profile, 80813152), Single Fusion (Deep Profile, 80808945), Mass Fusion (Deep Profile, LGSTR144)	96, 144, 80, 288
Number of Splice Trays – 80809958, 80813152, 80808945, LGSTR144	4, 4, 2, 2
Cable Ports <sup>1</sup>	4 (2 at each end)
Cable Diameters	0.093" – 1.20" (2.4 – 30.5 mm) and Flat Drop
Configuration	In-Line or Butt
Application	Direct Bury, Below Grade, Pole/Wall, Aerial only for 8006952, Indoor only for 80061049
Ingress Protection	In accordance to Telcordia® GR-771-CORE, Buried, Underground; IP-68
Size <sup>2</sup>	18.7" L x 10.0" W x 3.7" H (475 x 254 x 94 mm)

<sup>1</sup> Multi-hole grommets allow for more than one cable to enter each cable port.  
<sup>2</sup> Outermost part of the assembly.

Telcordia® is a registered trademark of Telcordia Technologies, Inc., now part of Ericsson.

### COYOTE In-Line RUNT Closure Kit Contents

Catalog Number	Description
8006951	In-Line RUNT Hermetically Sealed – Includes (2) 1-Hole Grommets 0.40" – 0.60" (10.1 – 15.2 mm), (1) 2-Hole Grommet 0.42" – 0.60" (10.7 – 15.2 mm), and, (1) 4-Hole Grommet 0.30" – 0.43" (7.6 – 10.9 mm)
8006952	In-Line RUNT Free Breathing – Includes (2) 1-Hole Grommets 0.40" – 0.60" (10.1 – 15.2 mm), (1) 2-Hole Grommet 0.42" – 0.60" (10.7 – 15.2 mm), and (1) 4-Hole Grommet 0.30" – 0.43" (7.6 – 10.9 mm)
80061049	In-Line RUNT Flame Retardant, Hermetically Sealed – Includes (2) 1-Hole Grommets 0.40" – 0.60" (10.1 – 15.2 mm), (1) 2-Hole Grommet 0.42" – 0.60" (10.7 – 15.2 mm), (1) 4-Hole Grommet 0.30" – 0.43" (7.6 – 10.9 mm), (1) 6-Hole Grommet 0.125" -0.250" (3.2 - 6.4 mm) and Flat Drop Cables, and a Torque Limiting Tool. For indoor use only.

All kits include (1) Closure Assembly, (4) Silicone Grommets and Cable Restraint Hardware (Splice Trays and Hanger Brackets Sold Separately)

## ▶ COYOTE® Silicone Grommets

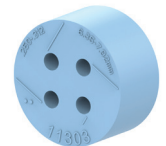
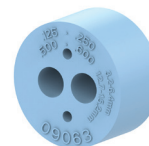
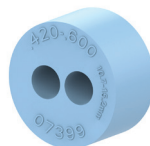
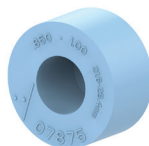
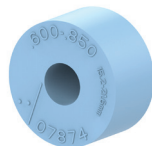
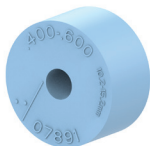

<b>Catalog No:</b> 8003691	<b>8003692</b>	<b>8003693</b>	<b>8003663</b>	<b>8003990</b>	<b>8004065</b>
----------------------------	----------------	----------------	----------------	----------------	----------------

0.40" - 0.60"  
(10.2 - 15.2 mm)

0.60" - 0.85"  
(15.2 - 21.6 mm)

0.85" - 1.00"  
(21.6 - 25.4 mm)

0.42" - 0.60"  
(10.7 - 15.2 mm)

0.50" - 0.60"  
(12.7 - 15.2 mm)

0.250" - 0.312"  
(6.4 - 7.9 mm)

0.125" - 0.250"  
(3.2 - 6.4 mm) and  
Flat Drop

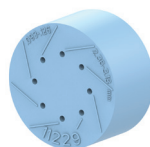
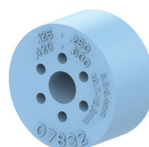
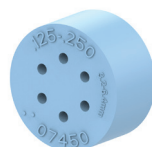
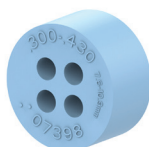

<b>Catalog No:</b> 8003664	<b>8003665</b>	<b>8003676</b>	<b>8004094</b>	<b>8003677</b>	<b>8004122</b>
----------------------------	----------------	----------------	----------------	----------------	----------------

0.30" - 0.43"  
(7.6 - 10.9 mm)

0.125" - 0.250"  
(3.2 - 6.4 mm)  
and Flat Drop

0.42" - 0.60"  
(10.7 - 15.2 mm)  
0.125" - 0.250"  
(3.2 - 6.4 mm) and  
Flat Drop

0.093" - 0.125"  
(2.4 - 3.2 mm)

0.125" - 0.250"  
(3.2 - 6.4 mm) and  
Flat Drop

RPX Only

## ▶ COYOTE® LITE-GRIP® Splice Trays

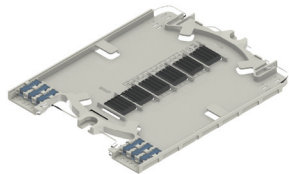

**Catalog Number: 80809958**  
Short – Low Profile  
Single Fusion  
24 Splice Count

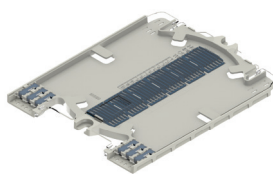

**Catalog Number: 80813152**  
Short – Low Profile  
Single Fusion  
36 Splice Count

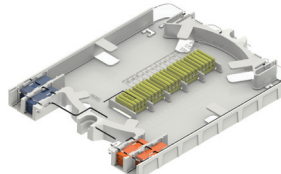

**Catalog Number: 80808945**  
Short – Deep Profile  
Single Fusion/Double Stack  
40 Splice Count

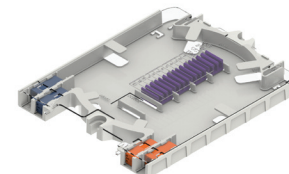

**Catalog Number: LGSTR144**  
Short – Deep Profile  
Ribbon/Mass Fusion  
144 Splice Count

### COYOTE In-Line RUNT Closure Accessories

Catalog Number	Description
80809958	Splice Tray, COYOTE LITE-GRIP Short, Low Profile, 24 CT., Single Fusion
80813152	Splice Tray, COYOTE LITE-GRIP Short, Low Profile, 36 CT., Single Fusion
80808945	Splice Tray, COYOTE LITE-GRIP Short, Deep Profile, 40 CT., Single Fusion
LGSTR144	Splice Tray, COYOTE LITE-GRIP Short, Deep Profile, 144 CT., Mass Fusion
8004160	Heat Shrink Splice Protector Kit – Includes (50) 40 mm Mass Fusion
8004095	Heat Shrink Splice Protector Kit – Includes (50) 40 mm Single Fusion
8003717	Heat Shrink Splice Protector Kit – Includes (50) 60 mm Single Fusion
80811124	6 Position SC/APC Cross-Connect Bulkhead
80811123	8 Position SC/APC Cross-Connect Bulkhead
80811126	6 Position SC/UPC Cross-Connect Bulkhead
80811125	8 Position SC/UPC Cross-Connect Bulkhead
80809054	Cross-Connect Bulkhead
8003733	End Plate Kit – Includes (1) End Plate Cap with Integrated Gasket, (1) Package of Silicone Lubricant, and (3) Bolts
80807794	Hardware Bag
8003862	Fiber Organizer Kit for Ribbon Applications
80805293	Transport Tube Kit – Includes (6) 0.135" (3.4 mm) ID x 34" (863 mm) Long Transport Tubes
80808639	Transport Tube Kit – Includes (3) 0.25" (6.3 mm) ID x 6' (1828 mm) Long Transport Tubes

### COYOTE In-Line RUNT Closure Mounting Brackets

Catalog Number	Description
8003797	Aerial Mounting Bracket – Strand Applications
8003864	Aerial Mounting Bracket – ADSS Applications
8003703	Pole/Wall Mounting Bracket
8003835	Universal Mounting Bracket – Handhole Applications
8003706	Swing Arm Mounting Bracket