

SCALE 1:1

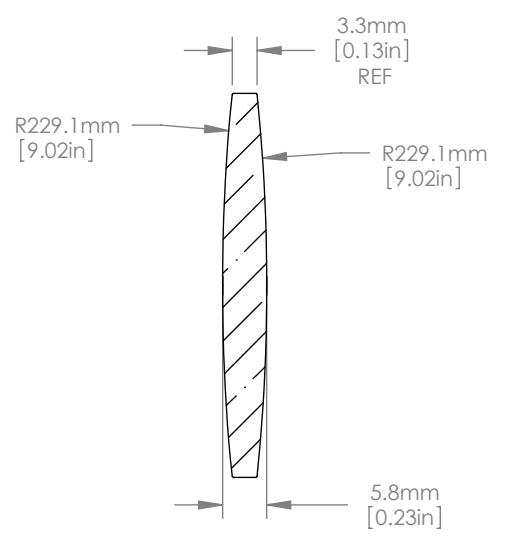
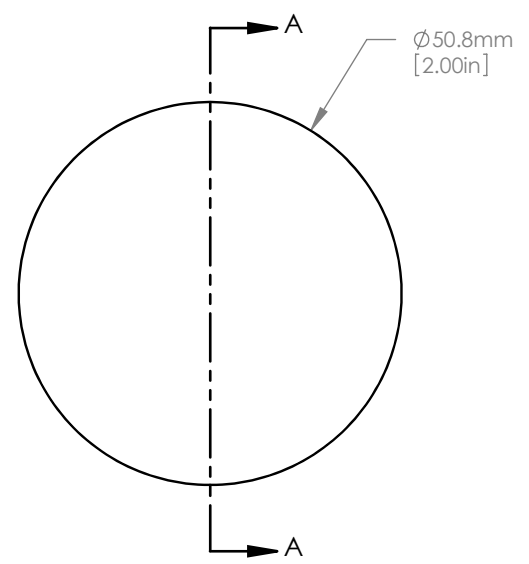

NOTES/SPECIFICATIONS:

1. DESIGN WAVELENGTH: 588nm
2. FOCAL LENGTH: $f=250.0\text{mm} \pm 1\%$
3. BACK FOCAL LENGTH(REF): $bf=248.0\text{mm}$
4. CLEAR APERTURE: $>90\%$
5. SURFACE QUALITY: 40-20 SCRATCH-DIG
6. CENTRATION: $\leq 3\text{arcmin}$
7. DIAMETER TOLERANCE: $+0.0/-0.1\text{mm}$
8. THICKNESS TOLERANCE: $\pm 0.1\text{mm}$

FOR INFORMATION ONLY
NOT FOR MANUFACTURING PURPOSES

DRAWING PROJECTION			Product Drawing	
NAME	DATE	D=50.8mm F=250.0mm UVFS BI CONVEX LENS		
DRAWN	GG	15/NOV/10	MATERIAL	REV
APPROVAL	JC	13/DEC/10	UV GRADE FUSED SILICA	C
VALUES IN PARENTHESIS ARE CALCULATED AND MAY CONTAIN ROUND OFF ERRORS			ITEM #	APPROX WEIGHT
			T-LB4972	0.04 kg