



Thank you for supporting our mission to create a greener planet through reforestation. Before starting, please make sure all pieces listed in this manual are complete. And save this manual for future reference.

When assembling, we recommend placing all wooden parts on a soft, clean and flat surface to avoid scratches and damage while assembling your need MasayaCo piece.

**Need any assistance?**

Feel free to contact our Customer Service Team.

(615) 953 - 9373,





[support@masaya.com](mailto:support@masaya.com)

or using our chat on [www.masayacompany.com](http://www.masayacompany.com)

🕒 15 Min

👤 2 people

🔧 Allen Hex Key

ID	Description	Qty	Reference
Ⓐ	Table Top	1	
Ⓑ	Legs	2	
Ⓒ	Decorative head bolts x 17mm x 1"	8	
Ⓓ	Decorative head bolts x 13mm x 1"	8	
Ⓔ	Allen Hex Key	1	

**Step 1**

Place the table top (Piece A) face down on an elevated and soft surface.

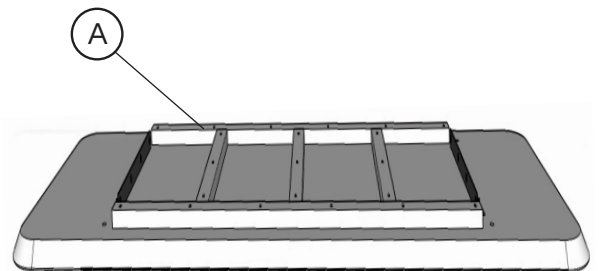

## Step 2

Place the legs (Pieces B) on the table top and attach it by using Pieces D. To screw this in place please use the Allen Hex Key included.

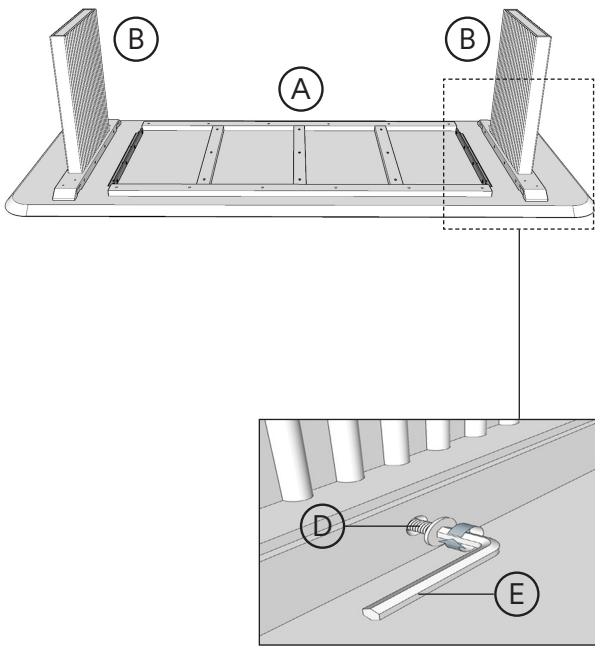

## Step 3

Secure the legs in place by screwing Pieces C with the Allen Hex Key.

