



Thank you for supporting our mission to create a greener planet through reforestation. Before starting, please make sure all pieces listed in this manual are complete. And save this manual for future reference.

When assembling, we recommend placing all wooden parts on a soft, clean and flat surface to avoid scratches and damage while assembling your brand new MasayaCo piece.

Need any assistance?





Feel free to contact our Customer Service Team.

(615) 953 - 9373,

customerservice@masayacompany.com

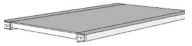
or using our chat on www.masayacompany.com

⌚ 30 Min 👤 1 person 🔑 Allen Hex Key

ID	Description	Qty	Reference
Ⓐ	Desk top with drawer	1	
Ⓑ	Wood Legs	2	
Ⓒ	Wood Rail	1	
Ⓓ	Decorative Head Bolt x 3 1/2"	6	
Ⓔ	Allen Hex Key	1	

Step 1

Place the table top (Piece A) face on an elevated and soft surface.

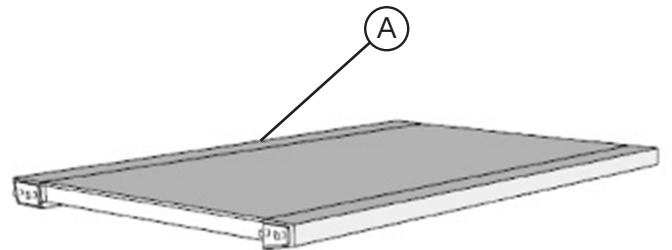

Step 2

Screw the legs (Piece B) in place using the Allen Hex Key.

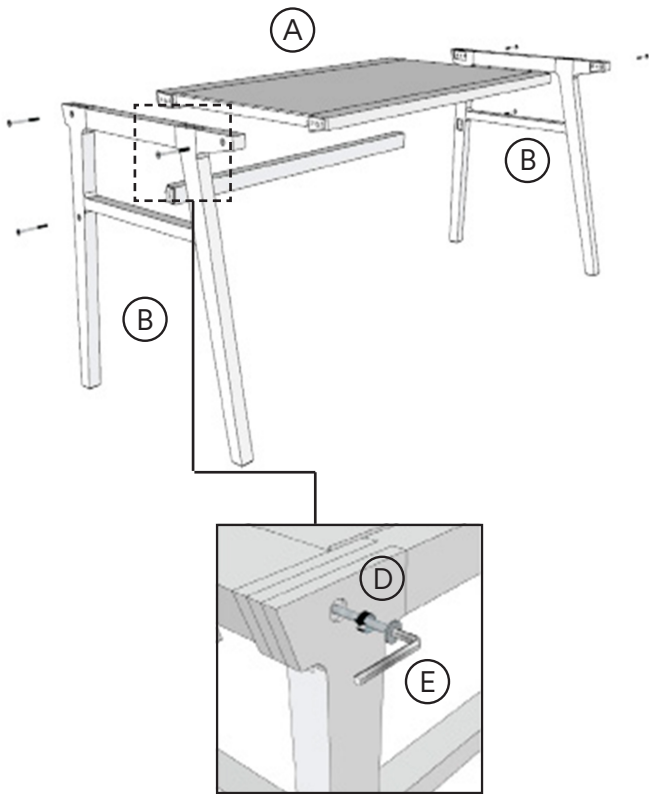

Step 3

At the same time fixed the wood rail (Piece C) in place with remaining screws.

