







**General Information**

Thank you for purchasing our product! Please refer to this assembly manual and make sure all pieces are complete before starting. Keep for future reference. When assembling, we recommend placing all wooden parts on a soft, clean and flat surface.

If you need any assistance during the assembly process, please contact our Customer Service Team at (615) 953 - 9373, email [support@masaya.com](mailto:support@masaya.com) or via live chat at [www.masayacompany.com](http://www.masayacompany.com)

**Component inventory**

ID	Description	Qty	Image
A	Desktop with drawer box	1	
B	Legs	2	
C	Wood Rail	1	
D	Decorative Head Bolt x 3 1/2"	6	
E	Decorative Head Bolt x 1 1/2"	2	
F	Allex Hex Key	1	



30 Min



1



Hard



Allen Hex Key

**Step 1**

Place the table top face down on an elevated and soft surface.



**Step 2**

Screw the legs in place using the Allen Hex Key.

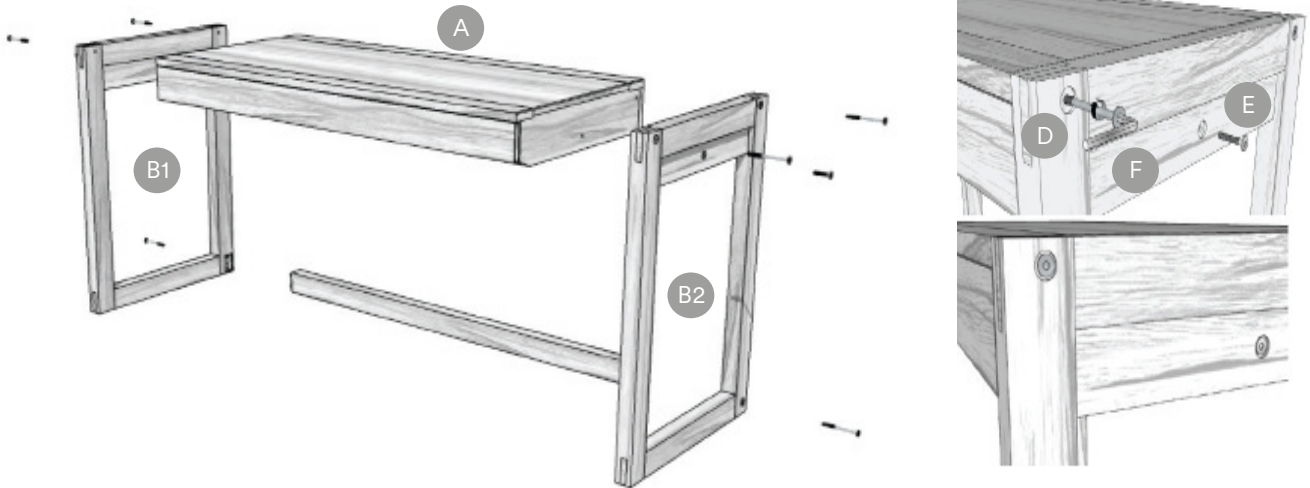

**Step 3**

Fixed the wood rail in place with remaining screws.

