



Thank you for supporting our mission to create a greener planet through reforestation. Before starting, please make sure all pieces listed in this manual are complete. And save this manual for future reference.







When assembling, we recommend placing all wooden parts on a soft, clean and flat surface to avoid scratches and damage while assembling your brand new MasayaCo piece.

Need any assistance?

Feel free to contact our Customer Service Team.

(615) 953 - 9373,
customerservice@masayacompany.com
 or using our chat on www.masayacompany.com

⌚ 15 Min 👤 1 person 🔑 Allen Hex Key

ID	Description	Qty	Reference
(A)	Solid Wood Top	1	
(B)	Shelf	1	
(C-1)	Wood Legs	1	
(C-2)	Wood Legs	1	
(D)	Decorative head bolts x 3.5".	8	
(E)	Allen Hex Key	1	

Step 1

Place the table top (Piece A) face down on an elevated and soft surface.

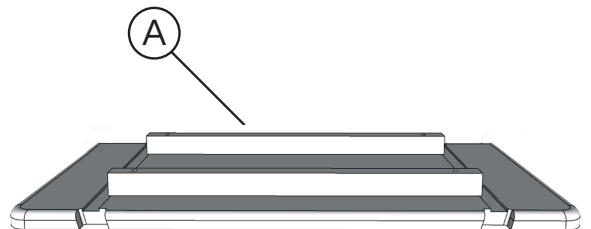

Step 2

Screw legs C-1 and C-2 in place by using the Allen Hex Key.

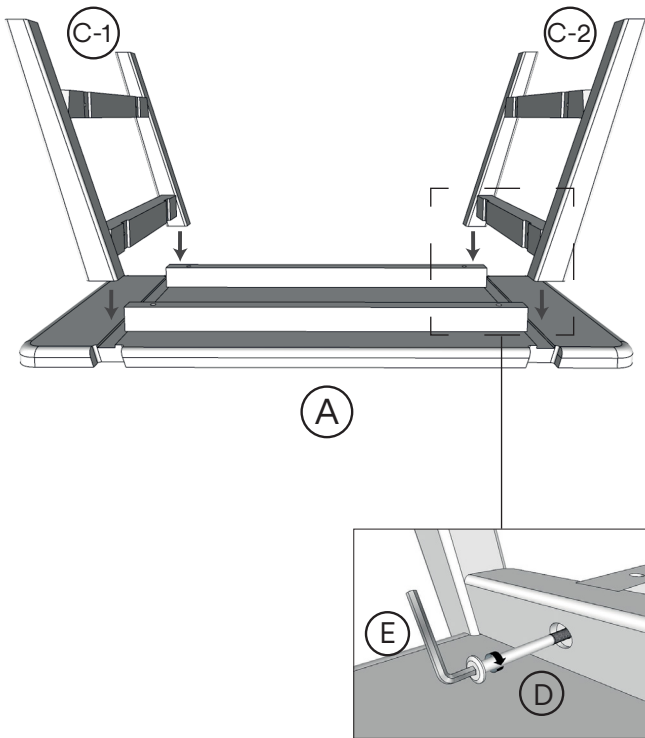

Step 3

Fixed the shelf (Piece B) in place.

