

**A RANGE OF INDUSTRIAL, OEM, COMMERCIAL,
DOMESTIC DRAUGHT EXCLUDERS & WEATHER STRIPS
BRUSH STRIPS, TIMBER SEALS, GLAZING GASKETS,
POLYPROPYLENE PILE SEALS
ALUMINIUM & PLASTIC CARRIERS
FOR VIRTUALLY ANY DOOR OR WINDOW**

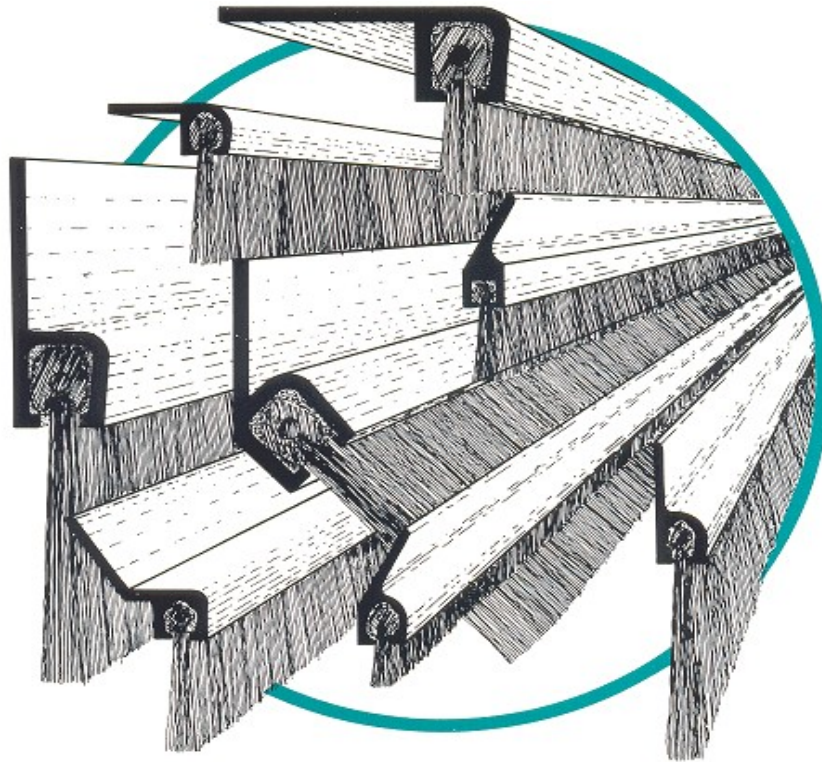

GEORGE CULLEY

**Unit 8 Dodgson
Industrial Estate
Dodgson Street
Rochdale
Lancashire , OL16 5SJ**

Tel: 0560 344 9596 (VOIP) OR 0161 622 0020

Tel: 0560 344 9597 (VOIP) OR 0161 622 0010

Email: gculley251@aol.com

www.rubber-extrusions-seals.co.uk

Over 1500 other parts in our Rubber Catalogue

Industrial & Commercial Brush Strips:
GEC PREMIER AND GEC PREMIER INDUSTRIAL

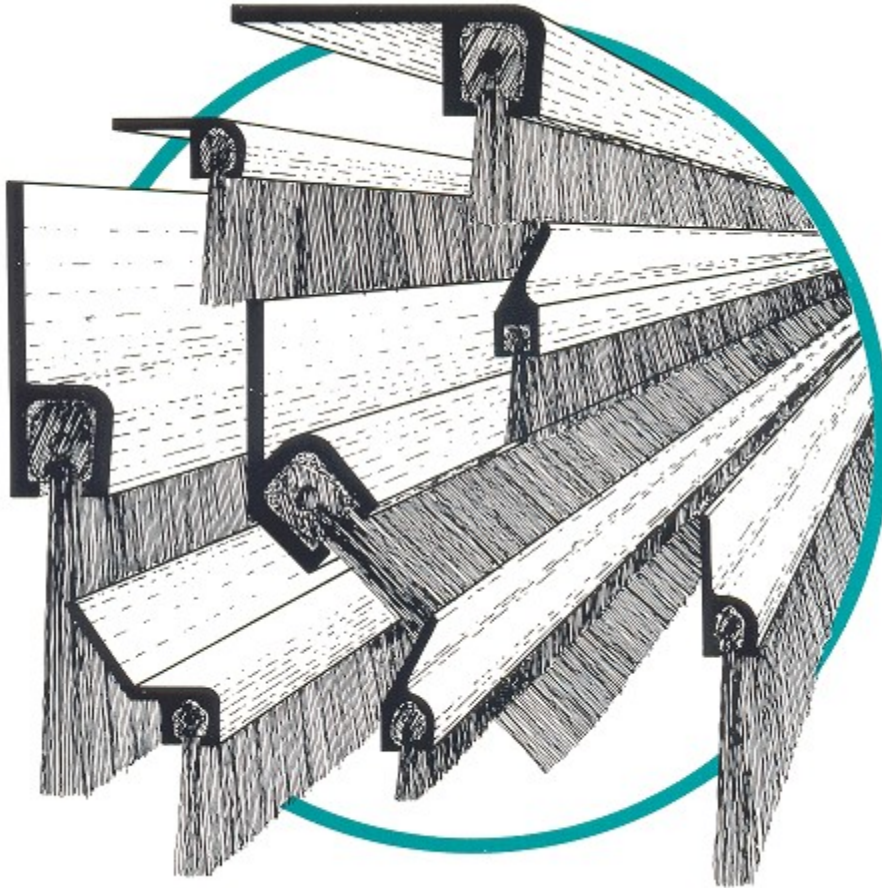

Features

- Available with a range of flat and angled aluminium carriers.
- 0.1 > 1.0, 1.5, 2.0, 2.1 and 3.0 metre lengths supplied as standard (see 'Specification' pages)
 - Can be cut to size/ fabricated to order – Please advise us of your requirements.
- Mill finish aluminium carrier supplied as standard – silver, bronze, black anodised finish or White powder coated to order (generally 2 to 3 week lead time).
 - Nylon 6 filament brush incorporating galvanised steel core wire and backing tape
Stainless Steel is available TO ORDER
 - Even, heavy density fill and trim ensuring no gaps in the brush.
 - Effective working temperatures: -40°C to +120°C (dry heat).
 - Nylon filament sizes increase with the length of the trim of the brush to allow use in horizontal positions.
 - Brushes with different filament sizes to those of our standard products (See 'Specification' pages) made to order.

We can also make Flexible backing brushes to order, The Design combination is endless!

Sliding Doors

Access through this type of door (even with a fork lift truck) is frequently gained by only partial opening of the doors. It is inevitable that although Industrial Brush Strip is of first class manufacture, even this will be damaged by such impact at the bottom of the lengths in a vertical plane. Therefore:

A Handy Tip

It is therefore, recommended, that in order to reduce the cost of eventual replacement, shorter lengths of the brush strip are applied to the opening edges of the Frame or Door – both horizontal and vertical, at low level – this assists in reduced costs if damage occurs!

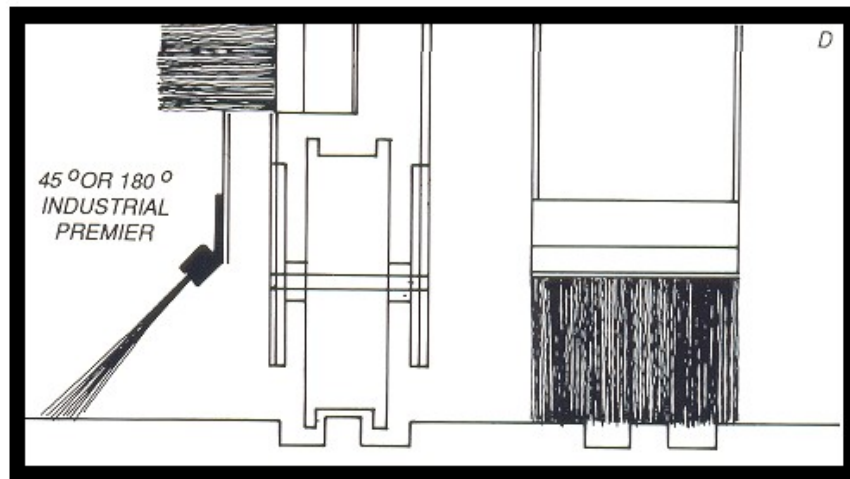
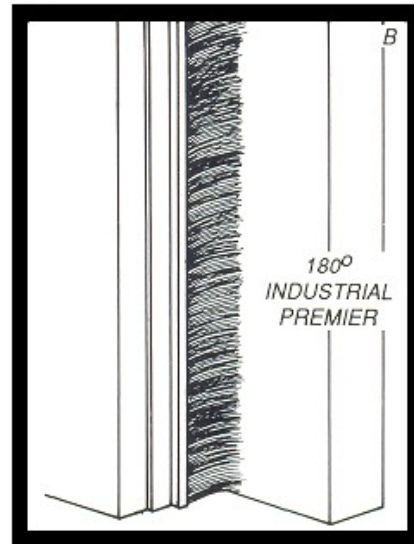
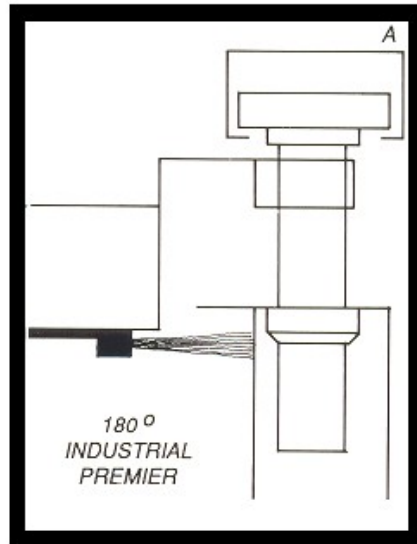
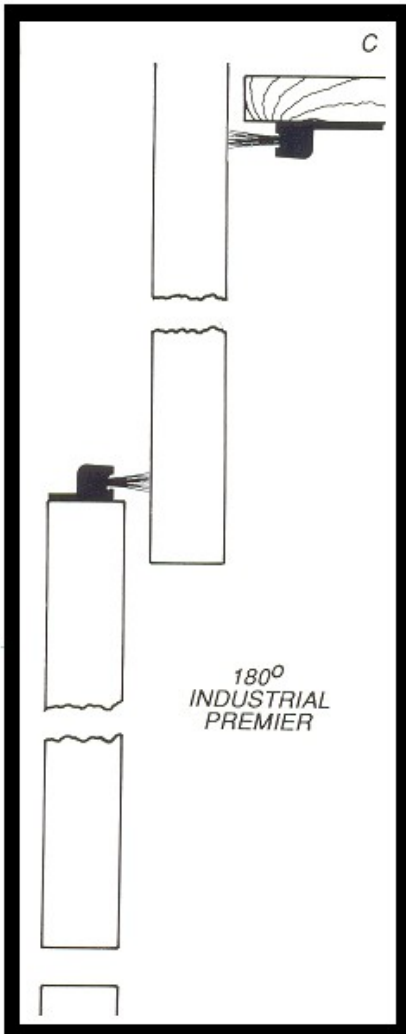
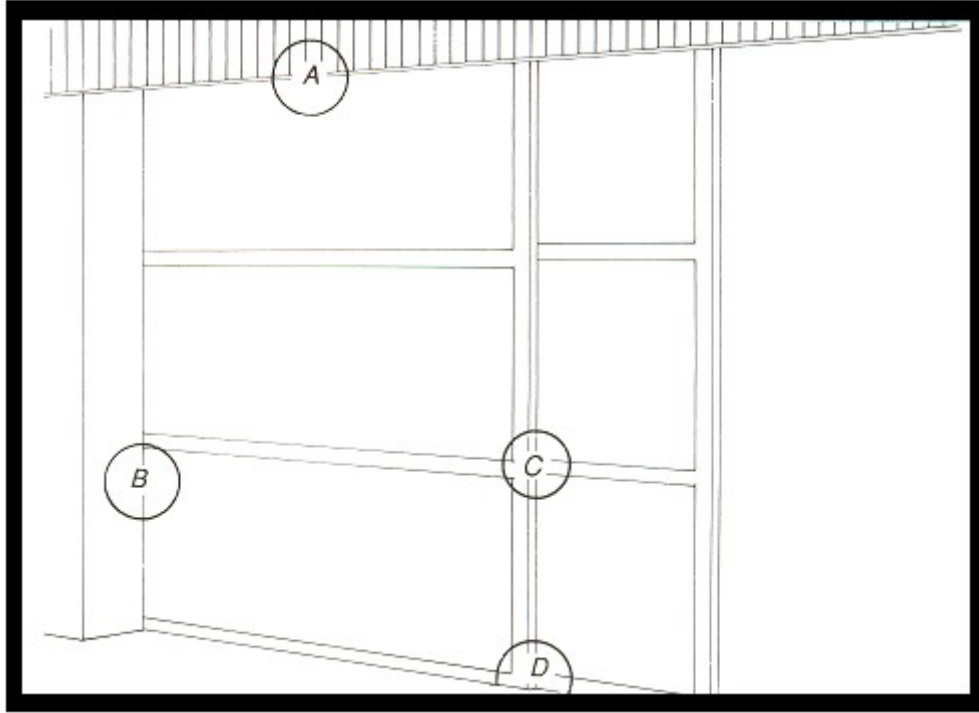

Conveyor Belts

Applied to the sides of conveyor belts, nylon brush strips eliminate components slipping under the belt and provide non-abrasive guides for transportation of PET/food containers. Whilst Industrial Premier Strip, usually with 45 degree angled carrier, will be required for large conveyors, 30 degree Brush Strip, aluminium carrier with 12mm trim nylon brush or Premier 30 with, say, 22mm trim brush may be sufficient for smaller belts.

FOR SIDE SKIRTS ON BOTTLING PLANTS OR PAINT CONTAINER AIR CONVEYORS LOOK AT FLEXIBAR !

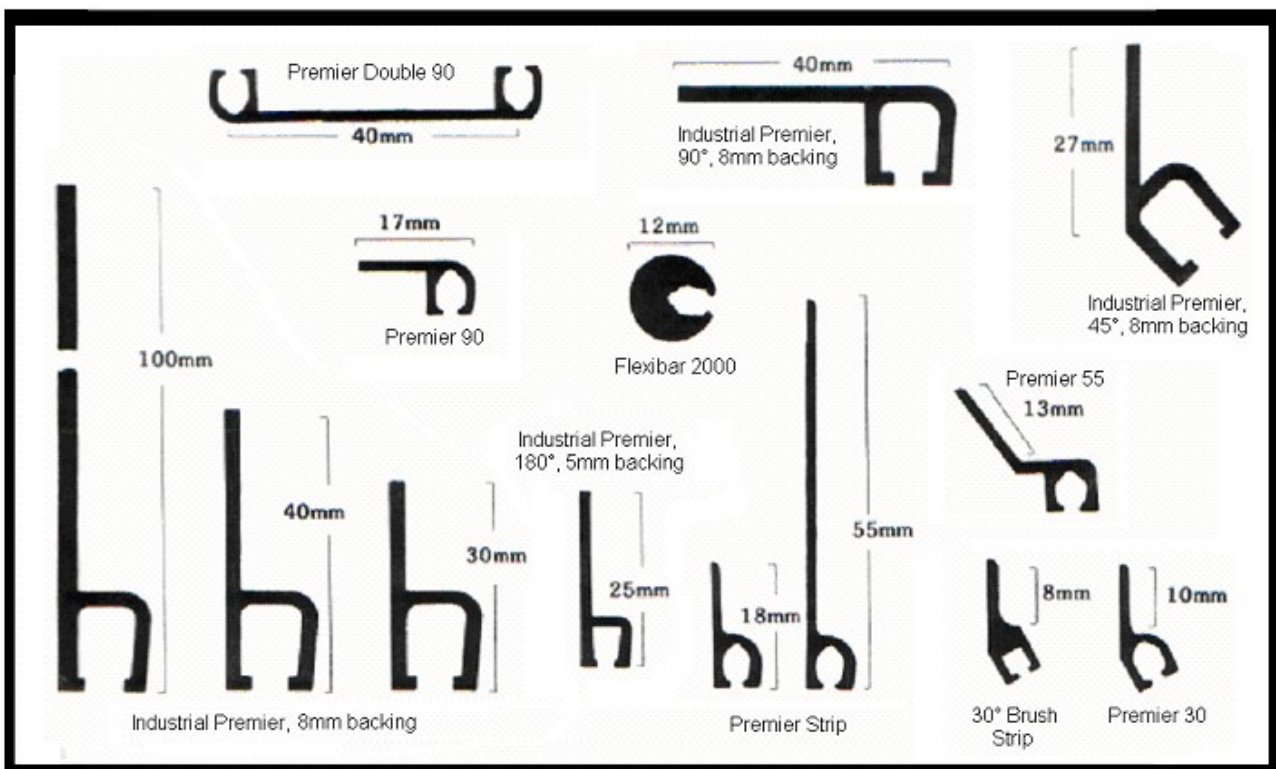
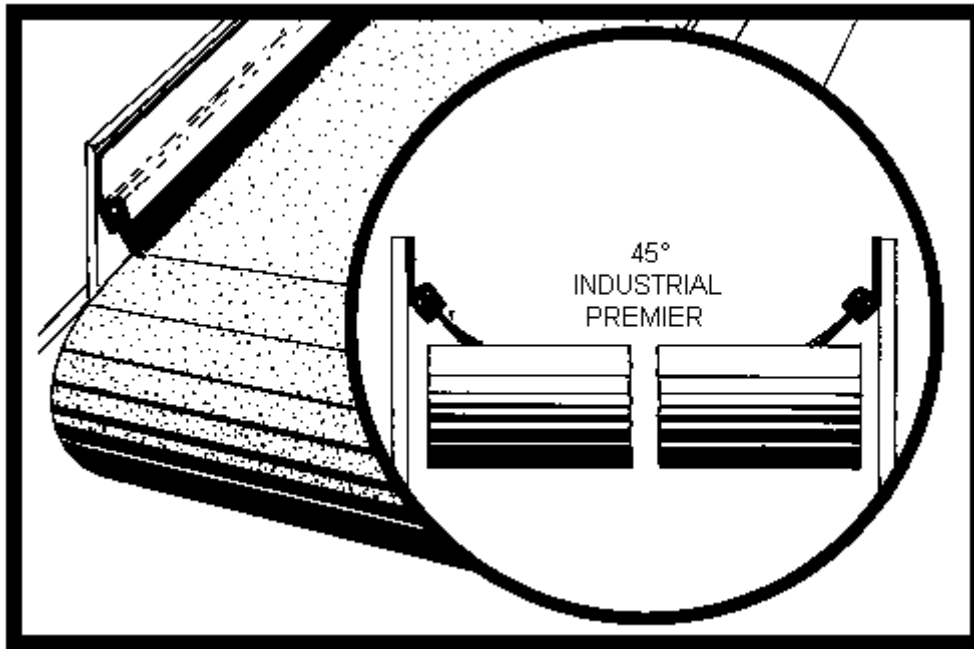

Fixing Instructions

1. When applying to the doors, the door should be in a closed position.
2. Measure the length of strip required and mark aluminium carrier where cut is to be made.
3. Slide brush from carrier and cut carrier to length with fine-toothed hacksaw 24 / 32 TPI.
4. Do not cut strip straight through the carrier and brush. Slide brush back into carrier and cut brush strip to size using piano wire cutters for smaller brushes and bolt cutters for larger brushes, ensuring end of brush is sealed to prevent loss of nylon filaments.
5. Secure brush in position by crimping ends of aluminium carrier.
6. Position carrier allowing 5%-10% compression of brush trim to the meeting surface and fix using self-tapping screws or pop-rivets at approximately 225mm (9in) centres. Please note additional fixings should be applied at each end of the carrier, within 25mm, for safety.
7. For aesthetic purposes, the aluminium carrier may be painted, BUT NOT THE NYLON BRUSH.

Roller Shutter Doors

GEC Industrial Brush Strip, usually with 45° angled carrier (or Premier 55 with 35mm brush, depending on cladding/frame finish OR laths), is applied to the sides and bottoms of roller shutter doors.

It is sometimes necessary to fit a timber batten (for fixing the strip to the sides) or metal spacer bar (to prevent fouling of the aluminium carrier on the ground – see diagram) before application of the brush strip. In this case, all timber should be treated with preservative to prevent rotting and spacer bars should be of aluminium or galvanised steel to prevent rusting.

To determine brush trim required to seal top of door, please check the maximum gap size with door in closed position. As a rule of thumb this usually determines the brush length to be fitted. We would recommend that an aluminium carrier with a minimum of 30mm fixing leg be used to ensure fixings are not too close to the edge of structural steelwork or cladding.

Brush strip fitted to the tops of roller shutters will restrict bird entry. Fitted at the base it will help reduce water penetration and rodent infestation.

PLEASE ENSURE CORRECT EQUIPMENT IS USED FOR FITTING STRIP AT HEIGHT, DO NOT USE A LADDER WITH NO ONE SUPPORTING THE BOTTOM OF THE LADDER , OR BE SAFE USE A TOWER !!

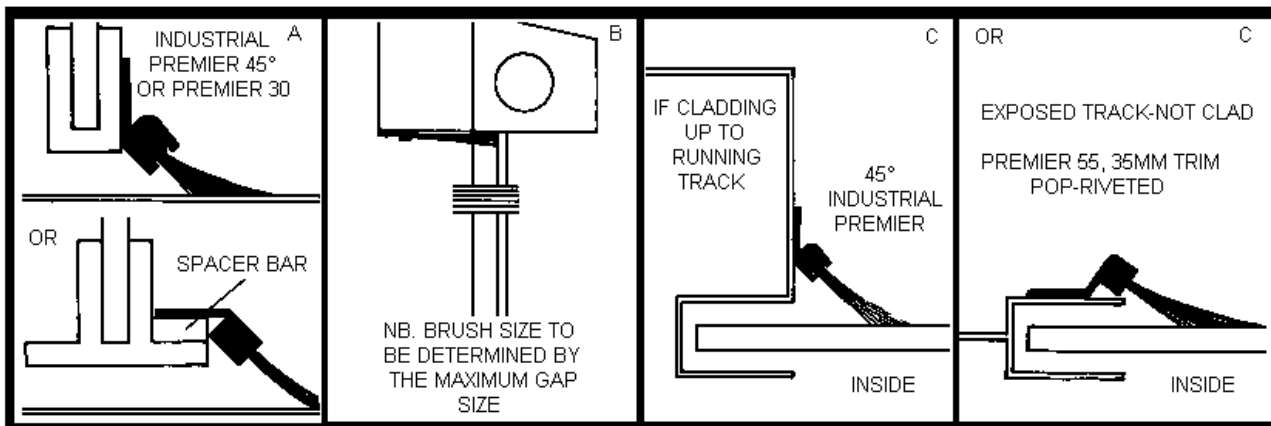
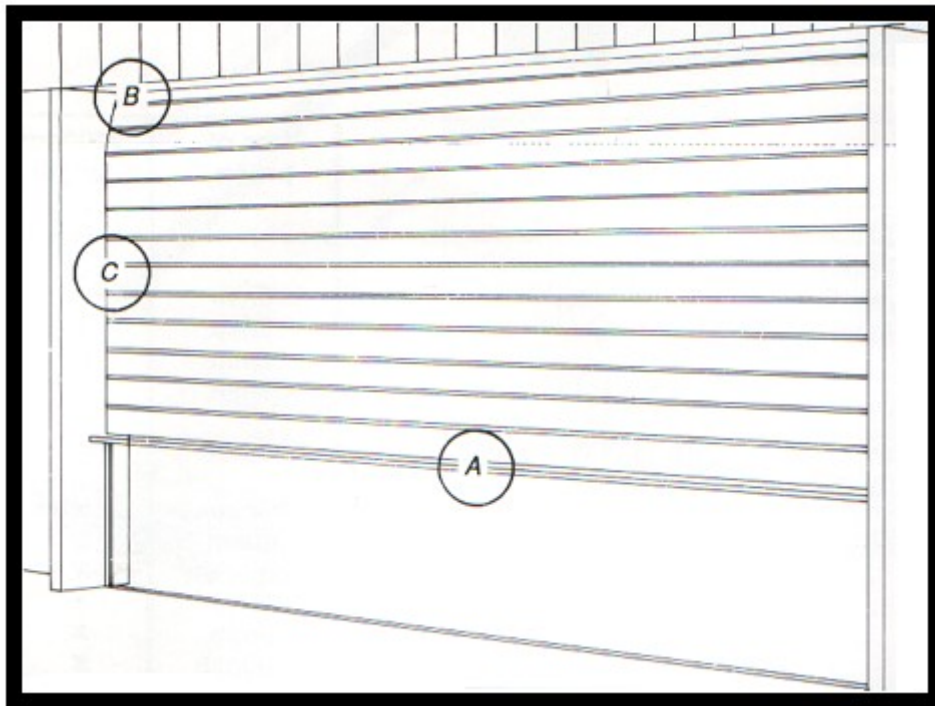

DO YOU Need design / OR applications assistance?

Phone us NOW on 0560 344 9596 or 0161 622 0020
Or fax us on 0560 344 9597 or 0161 622 0010
Or email us at gculley251@aol.com

Specification

	CUT LENGTHS ARE ALSO AVAILABLE	Trim of brush	1M length (+ / - 5mm)	1.5M length (+ / - 5mm)	2M length h (+ / - 5mm)	2.1M length	3M length h	Nylon diam (mm)	
<u>180 degree (flat)</u>	Premier Strip, 4mm backing 18mm overall carrier height	10mm	Y	Y	Y	Y	Y	0.15	
		15mm	Y	Y	Y	Y	Y	0.15	
		22mm	Y	Y	Y	Y	Y	0.20	
		25mm	Y	Y	Y	Y	Y	0.20	
		30mm	Y	Y	Y	Y	Y	0.20	
		35mm	Y	Y	Y	Y	Y	0.20	
		40mm	Y	Y	Y	Y	Y	0.25	
		45mm	Y	Y	Y	Y	Y	0.25	
		50mm	Y	Y	Y	Y	Y	0.25	
		Premier Strip, 4mm backing 55mm overall carrier height ALSO HEAVIER SECTION	10mm	Y	Y	Y	Y	Y	Y
	15mm		Y	Y	Y	Y	Y	Y	0.15
	22mm		Y	Y	Y	Y	Y	Y	0.20
	25mm		Y	Y	Y	Y	Y	Y	0.20
	30mm		Y	Y	Y	Y	Y	Y	0.20
	35mm		Y	Y	Y	Y	Y	Y	0.20
	40mm		Y	Y	Y	Y	Y	Y	0.25
	45mm		Y	Y	Y	Y	Y	Y	0.25
	50mm		Y	Y	Y	Y	Y	Y	0.25
	Industrial Premier Strip, 5mm backing 25mm overall carrier height		25mm	Y	Y	Y	N	Y	Y
		50mm	Y	Y	Y	N	Y	Y	0.25
	Industrial Premier Strip, 8mm backing 30mm, 34 MM ,40mm or 100mm overall carrier height	25mm	Y	Y	Y	N	Y	Y	0.20
		35mm	Y	Y	Y	N	Y	Y	0.25
		40mm	Y	Y	Y	N	Y	Y	0.25
		50mm	Y	Y	Y	N	Y	Y	0.30
		75mm	Y	Y	Y	N	Y	Y	0.40
		100mm	Y	Y	Y	N	Y	Y	0.50
		125mm	Y	Y	Y	N	Y	Y	0.60
	150mm	Y	Y	Y	N	Y	Y	0.60	
<u>30 degree angle</u>	Premier 30, 4mm backing 18mm overall carrier height, 10mm fixing leg	10mm	Y	Y	Y	Y	Y	0.15	
		15mm	Y	Y	Y	Y	Y	0.15	
		22mm	Y	Y	Y	Y	Y	0.20	
		25mm	Y	Y	Y	Y	Y	0.20	
		30mm	Y	Y	Y	Y	Y	0.20	
		35mm	Y	Y	Y	Y	Y	0.20	
		40mm	Y	Y	Y	Y	Y	0.25	
		45mm	Y	Y	Y	Y	Y	0.25	
		50mm	Y	Y	Y	Y	Y	0.25	
	30 degree Brush Strip, 3mm backing 18mm overall carrier height, 8mm fixing leg	12mm	N	N	N	Y	N	Y	0.15
	<u>45 degree angle</u>	Industrial Premier Strip, 8mm backing 27mm fixing leg	25mm	Y	Y	Y	N	Y	0.20
35mm			Y	Y	Y	N	Y	0.25	
40mm			Y	Y	Y	N	Y	0.25	
50mm			Y	Y	Y	N	Y	0.30	
75mm			Y	Y	Y	N	Y	0.40	
100mm			Y	Y	Y	N	Y	0.50	
125mm			Y	Y	Y	N	Y	0.60	
150mm			Y	Y	Y	N	Y	0.60	
<u>55 degree angled</u>	Premier 55, 4mm backing 13mm fixing leg	10mm	Y	Y	Y	Y	Y	0.15	
		15mm	Y	Y	Y	Y	Y	0.15	
		22mm	Y	Y	Y	Y	Y	0.20	
		25mm	Y	Y	Y	Y	Y	0.20	
		30mm	Y	Y	Y	Y	Y	0.20	
		35mm	Y	Y	Y	Y	Y	0.20	
		40mm	Y	Y	Y	Y	Y	0.25	
		45mm	Y	Y	Y	Y	Y	0.25	
		50mm	Y	Y	Y	Y	Y	0.25	

Specification

		Trim of brush	1M length (+ / - 5mm)	1.5M length (+ / - 5mm)	2M length (+ / - 5mm)	2.1M length	3M length	Nylon diameter (mm)	
90 degree angle	Premier 90, 4mm backing 17mm overall carrier height	10mm	Y	Y	Y	Y	Y	0.15	
		15mm	Y	Y	Y	Y	Y	0.15	
		22mm	Y	Y	Y	Y	Y	0.20	
		25mm	Y	Y	Y	Y	Y	0.20	
		30mm	Y	Y	Y	Y	Y	0.20	
		35mm	Y	Y	Y	Y	Y	0.20	
		40mm	Y	Y	Y	Y	Y	0.25	
		45mm	Y	Y	Y	Y	Y	0.25	
		50mm	Y	Y	Y	Y	Y	0.25	
	Premier Double 90, 4mm backing 40mm overall carrier height	10mm	Y	Y	Y	Y	Y	Y	0.15
		15mm	Y	Y	Y	Y	Y	Y	0.15
		22mm	Y	Y	Y	Y	Y	Y	0.20
		25mm	Y	Y	Y	Y	Y	Y	0.20
		30mm	Y	Y	Y	Y	Y	Y	0.20
		35mm	Y	Y	Y	Y	Y	Y	0.20
		40mm	Y	Y	Y	Y	Y	Y	0.25
		45mm	Y	Y	Y	Y	Y	Y	0.25
		50mm	Y	Y	Y	Y	Y	Y	0.25
	Industrial Premier Strip, 8mm backing 40mm overall carrier height	25mm	Y	Y	Y	N	Y	Y	0.20
		35mm	Y	Y	Y	N	Y	Y	0.25
		40mm	Y	Y	Y	N	Y	Y	0.25
		50mm	Y	Y	Y	N	Y	Y	0.30
		75mm	Y	Y	Y	N	Y	Y	0.40
		100mm	Y	Y	Y	N	Y	Y	0.50
		125mm	Y	Y	Y	N	Y	Y	0.60
	150mm	Y	Y	Y	N	Y	Y	0.60	
	Flexibar	Flexibar 2000 12mm diameter round carrier WITH BENDING EQUIPMENT IT CAN BE BENT IN BOTH PLANES	10mm	Y	N	Y	N	N	N
15mm			Y	N	Y	N	N	N	0.15
22mm			Y	N	Y	N	N	N	0.20
25mm			Y	N	Y	N	N	N	0.20
30mm			Y	N	Y	N	N	N	0.20
35mm			Y	N	Y	N	N	N	0.20
40mm			Y	N	Y	N	N	N	0.25
45mm			Y	N	Y	N	N	N	0.25
50mm			Y	N	Y	N	N	N	0.25

ANY OF THE PRODUCTS ON THESE TWO 'SPECIFICATION' SHEETS CAN BE CUT TO SIZE TO ORDER. PLEASE ADVISE US OF YOUR REQUIREMENTS AND WE WILL BE PLEASED TO PROVIDE YOU WITH OUR QUOTATION.

**PLEASE RING : 0560 344 9596 (VOIP) OR 0161 622 0020
OR FAX :0560 344 9597 (VOIP) OR 0161 622 0010**

**WE CAN NOW MANUFACTURE TO ORDER A VARIETY OF FLEXIBLE BACKED BRUSHES USING TPR CARRIERS AND PUNCH FILLING TECHNIQUE
MOQ ONLY 15 METRES ! 3 - 4 WEEK LEAD TIME**

Flexi-glo Fingerguard

TRAPPED FINGERS HURT !!

THIS PROBLEM IS A POTENTIAL FOR BEING SUED

BE SAFE

**THIS MATERIAL DESIGNED BY GEORGE CULLEY ALSO SHOWS
THE EDGE OF THE DOOR IN A POWER CUT !**

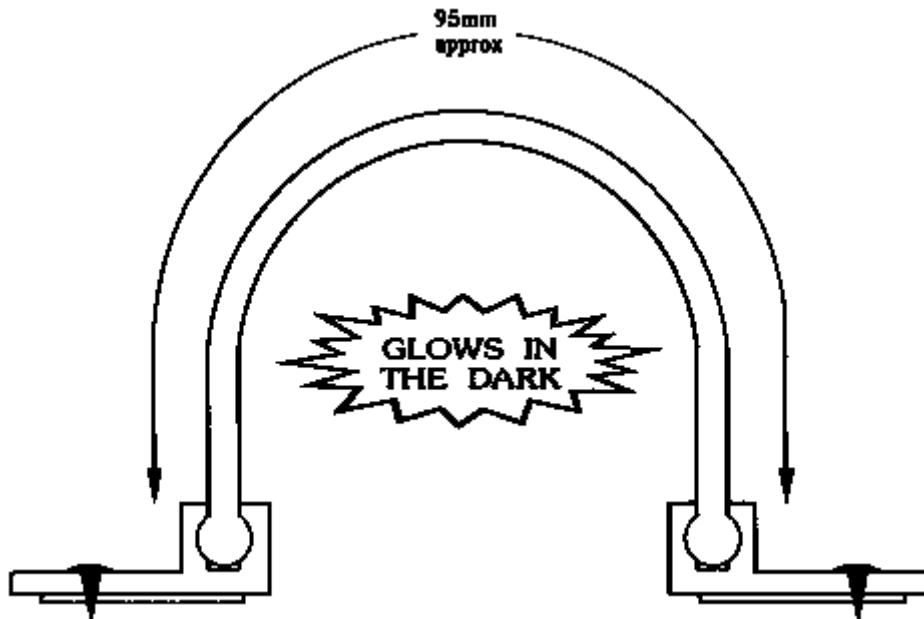

Features

- * Aluminium fixing plates incorporating unique glow in the dark silicone rubber
This in the event of a power failure, it glows for approximately 20 minutes
- * Prevents finger trapping
- * Applied to the hinge sides of doors will, in the event of a fire, give added
Protection up to 200 degrees C
- * Can be used to seal or highlight any variable aperture on single action doors
 - * No resistance to the closure of doors fitted with closers
- * Easy to install – self-adhesive tape allows correct placing of aluminium holder
Before screwing in position
 - * Easy to clean – simply wipe with a damp cloth
 - * Silicone rubber extruded to BS3734
- * Available in various finishes – standard aluminium, and black, bronze or matt
gold anodised or white painted aluminium to order
- * Unlike plastic type products Flexi-glo retains its flexibility and does not split
 - * 2.1 metre and 2.5 metre lengths supplied as standard

Flexi-glo Fingerguard

INSTALLATION INSTRUCTIONS

1. Please start with clean hands.
2. Ensure the door, where the Fingerguard is to be fitted, opens and closes correctly.
3. Oil/lubricate all hinges.
4. Clean surfaces where the tape is to be fitted using a 3M VHB cleaner pad or degreaser
DO NOT USE WHITE SPIRIT
5. Cut the product to the height of the door. Use a fine tooth hacksaw to cut the aluminium profiles with a straight edge. De-bur any sharp edges. Use a sharp blade to cut the rubber section.
6. With the door closed apply Flexi-glo to the door jamb first so as not to interfere with the door, ie. Leave approximately 5-10mm gap between the edge of the aluminium and the door frame. Then apply the second carrier to the door leaving sufficient clearance – Flexi-glo bulbs outwards.
7. Remove the release tapes and place in position one at a time ensuring both are parallel. **DO NOT TOUCH THE TAPE WITH YOUR FINGERS.**
8. Using the self-tapping screws provided screw the product in position ensuring the fixings are 25mm from each end drilling extra holes if necessary.
9. Ensure the door opens and closes correctly.
10. Clean the aluminium with a cloth to remove any fingerprints.
11. Ensure all off cuts and loose screws are removed from site.

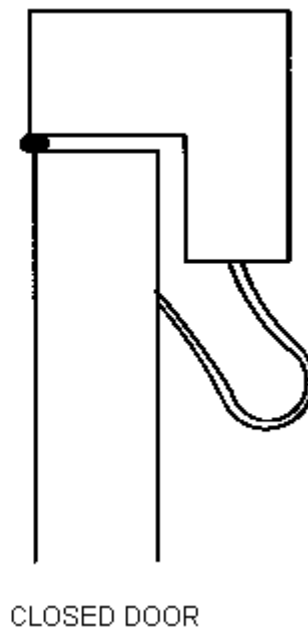
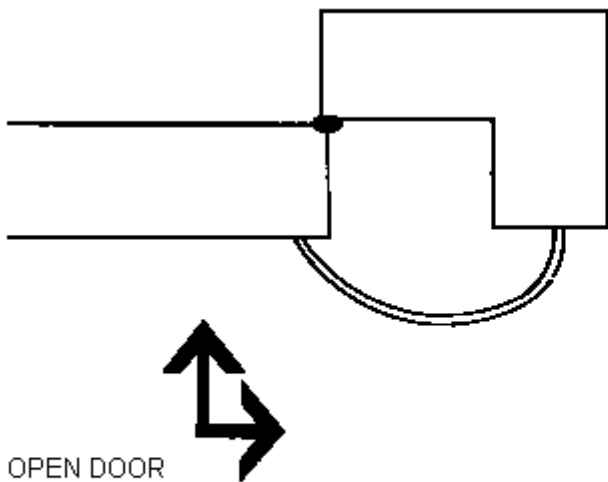

Flexi-glo can also be used on any corner to highlight Any aperture in the event of a power failure.

30 degree Brush Strip Perimeter Seal

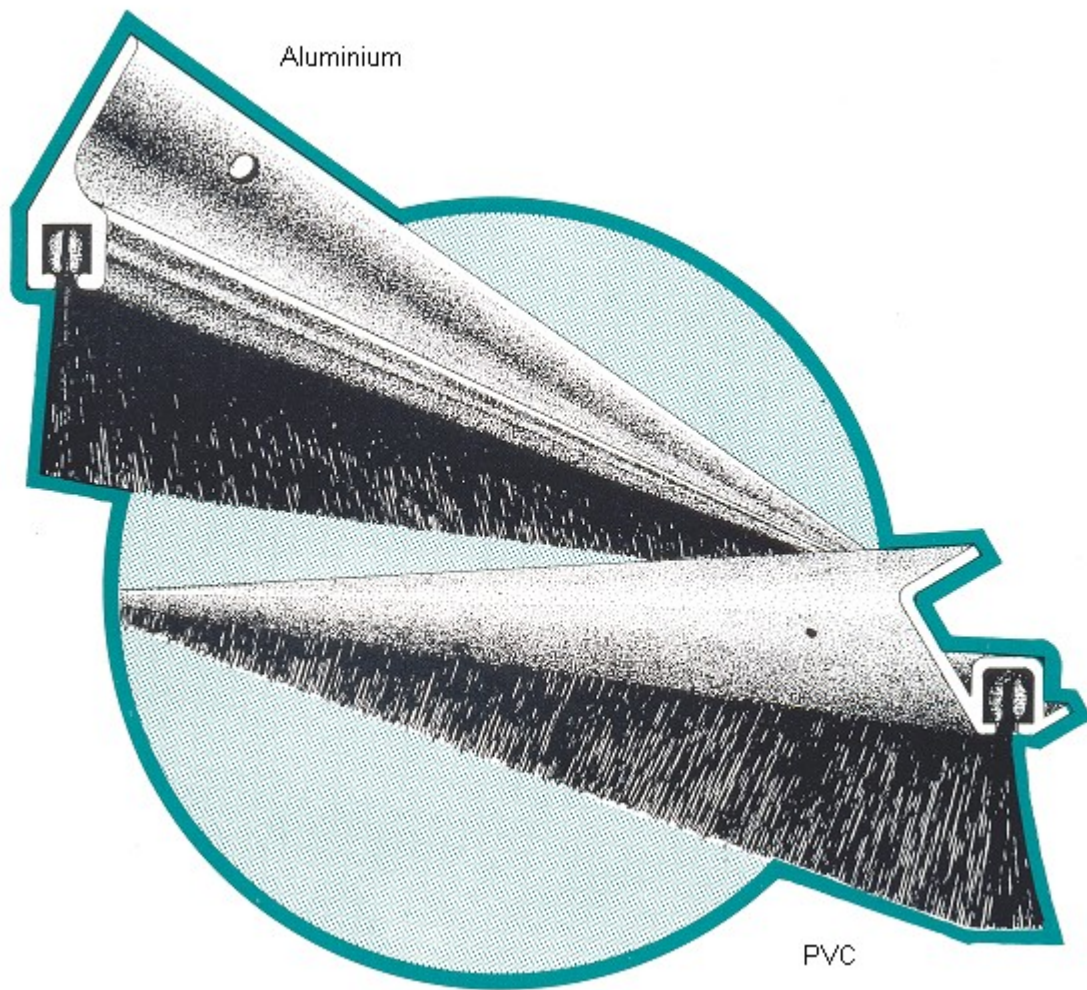

Features

- * Carrier available in various finishes – white UPVC, brown PVC and standard aluminium or satin, Black, bronze or matt gold anodised or white painted aluminium to order
- * Supplied in 2.1 metre lengths
- * 12mm trim, black or white, 0.15mm nylon 6 brush with galvanised steel core wire and backing tape
- * PVC sections are pre-drilled for acceptance of stainless steel pins as supplied
- * Aluminium sections can be supplied undrilled or drilled for acceptance of No 6 zinc plated Steel screws as supplied

30 degree Brush Strip Perimeter Seal

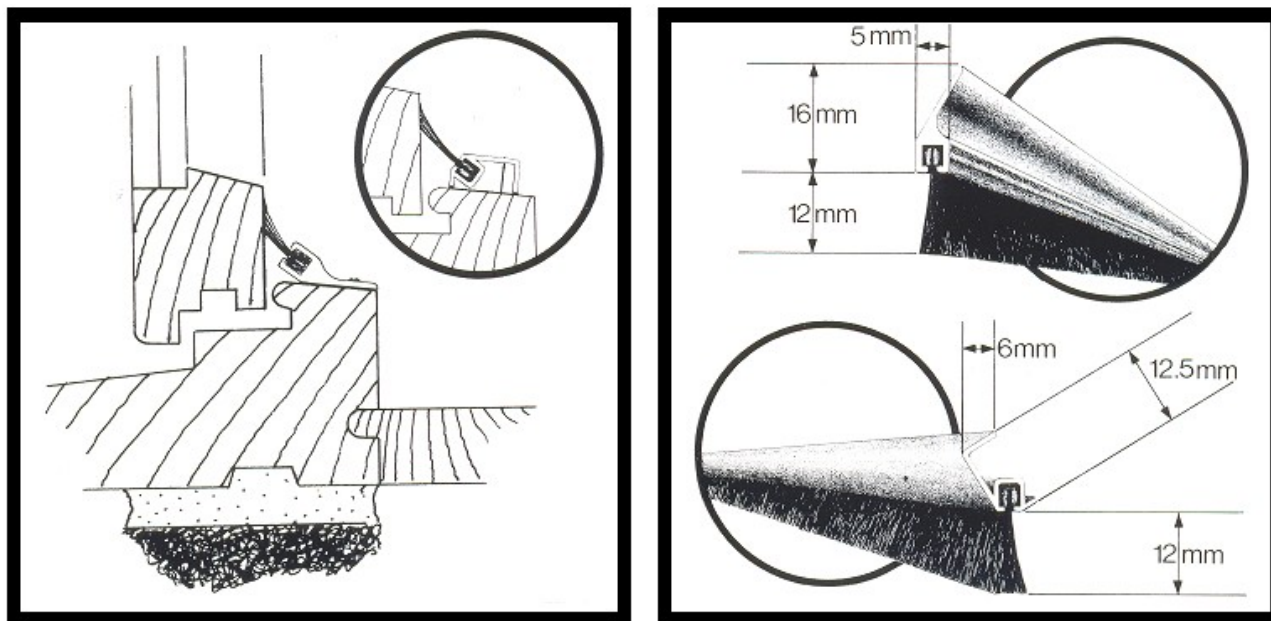

FIXING INSTRUCTIONS

1. 30 degree Brush Strip should be applied to a door/window in a closed position.
2. Measure frame width.
3. Mark off required length on carrier.
4. Slide out brush from carrier.
5. Hacksaw carrier to required length. Clean swarf from ends.
6. Reposition brush into carrier, level with the cut end.
7. Cut off excessive brush strip, using pincers or wire cutters only, ensuring that the cut end of the strip is re-crimped.
8. Aluminium – lightly crimp both ends of the extrusions to secure the strip. PVC – if the brush is slightly loose in the carrier, slide out brush from carrier 2-3 inches. Lightly bend brush and tap back into carrier.
9. Pin or screw in position.

FOR A REALLY PROFESSIONAL FINISH, IT IS RECOMMENDED THAT APPROPRIATELY COLOURED SILICONE SEALANT BE APPLIED TO BUTT OR MITRED JOINTS.

GEC Premier Strip Straight 180 degree & GEC Premier 55 Cranked Door Bottoms

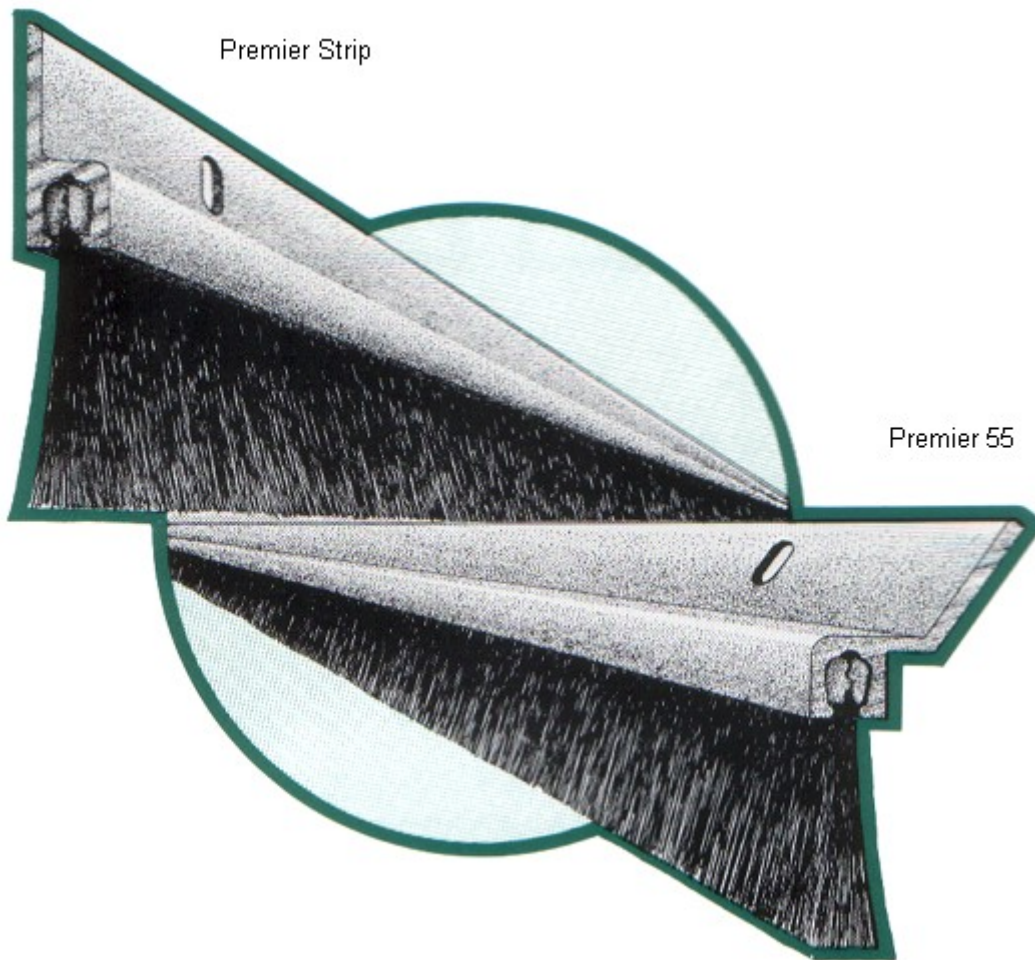

Features

PREMIER STRIP –

- * PVC: Available in 0.10 to 0.89, 1.0, 1.5, 2.0, 2.1 metre lengths – cut lengths available to order
- * ALUMINUM : Available in 0.10 to 0.89, 1.0, 1.5, 2.0, 2.1 and 3.0 metre lengths – cut lengths available to order
 - * Carrier available in various finishes – white PVCu, brown PVC, standard aluminium, TO ORDER : satin, black, bronze or matt gold anodised or white painted aluminium
- * 890mm lengths supplied, undrilled or drilled to order, incorporating 22mm trim black nylon brush
- * 2.1 and 3 metre lengths supplied undrilled, drilled to order, incorporating 10mm, 15mm, 22mm, 25mm, 30mm, 35mm, 40mm, 45mm or 50mm trim black nylon brush

PREMIER 55 –

- * Available in 890 mm lengths – Other cut lengths available to order
 - * Carrier available in various finishes – standard aluminium, satin, black, bronze or matt gold anodised Or white painted aluminium
 - * 890 mm lengths supplied undrilled, drilled to order, incorporating 22mm trim black nylon brush
 - * subject to MOQ :2.1 and 3 metre lengths supplied undrilled, drilled to order, incorporating 10mm, 15mm, 22mm, 25mm,30mm, 35mm, 40mm, 45mm or 50mm trim black nylon brush
- All strips supplied are Nylon 6 and incorporate galvanised steel core wire and backing tape
 - Flexible backed brushes made to order , MOQ is 15 metres , 3 to 4 weeks , all sizes

Premier Strip and Premier 55

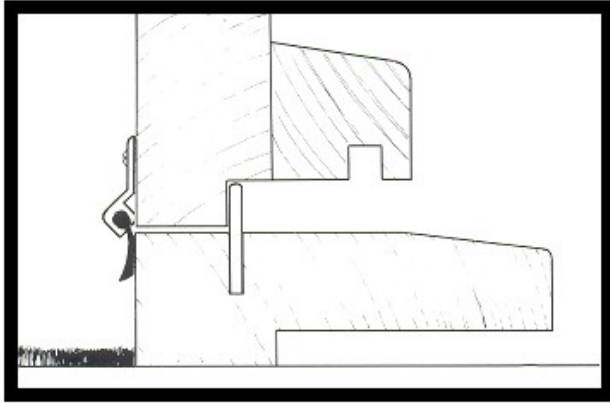

FIXING INSTRUCTIONS

1. The Premier Strip and Premier 55 should be applied to a door in a closed position.
2. Measure door width.
3. Mark off required length on carrier.
4. Slide out brush from carrier.
5. Hacksaw carrier to required length.
6. Reposition brush into carrier, level with the cut end.
7. Cut off excessive brush strip, using pincers or wire cutters only, ensures that the cut end of the strip is re-crimped.
8. Aluminium – lightly crimp both ends of the extrusion to secure the strip. PVC – if the brush is slightly loose in the carrier, slide out brush from carrier 2-3 inches, lightly bend brush and tap back into carrier.
9. Place Premier Strip at the bottom of the door, ensuring contact is made with the threshold/floor. Apply pressure to the strip and screw in position. Ensure fixings within 25 mm from each end.

Mailseal

Features

- * Manufactured in hard PVC
- * Available in white or brown
- * Approximate overall size - 310mm x 80mm
- approximate opening - 275mm x 56mm
- * The Mailseal eliminates draughty letter-box problems

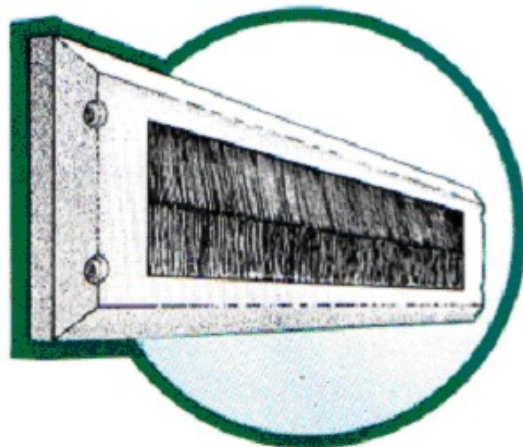

GEC Blok-Kade D

Industrial Door Seal – Option 1 – Bottom of Roller Shutter Door with 75 mm T Bar

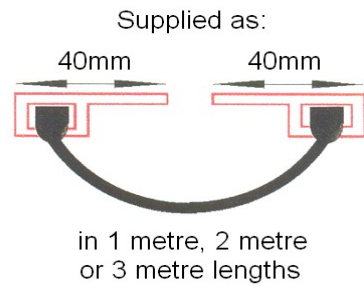
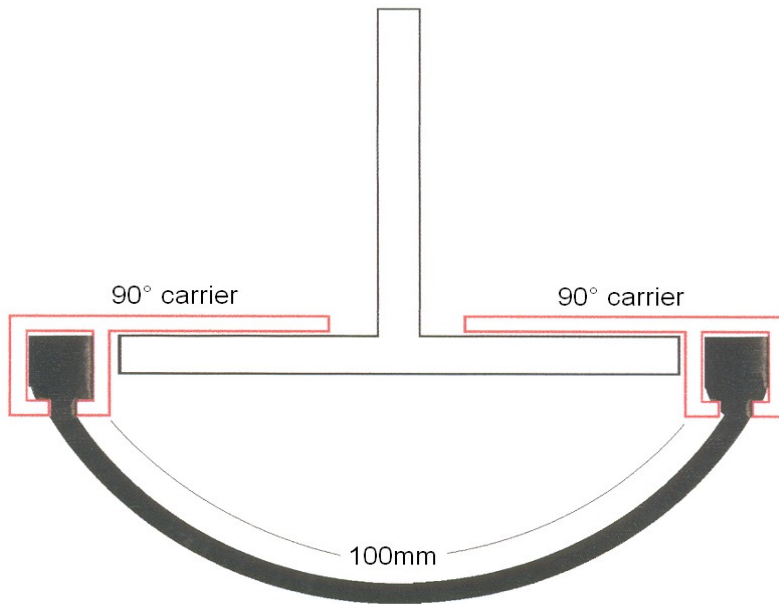

Industrial Door Seal – Option 2 – Insulated Door, or Square base door

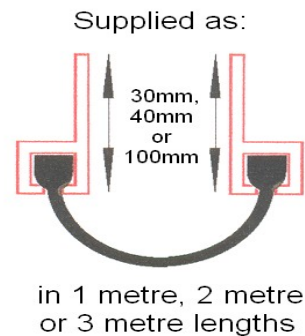
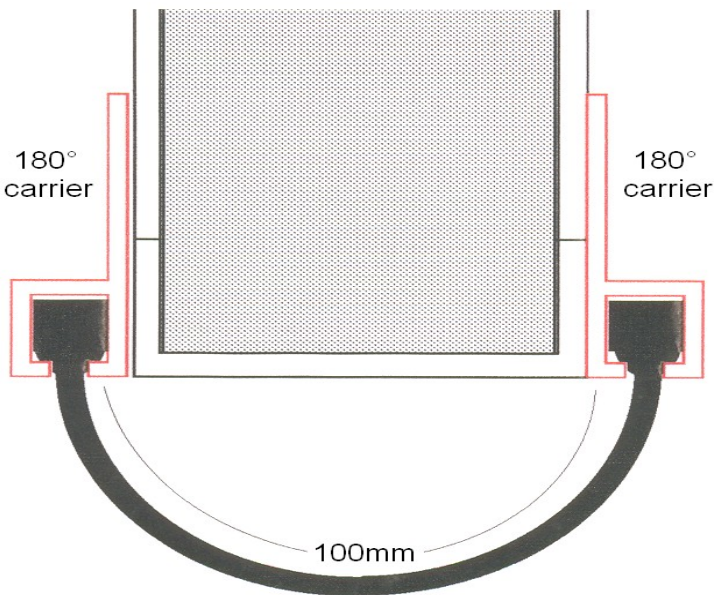

Features

- * Seal consists of two pieces of mill finish aluminium carrier for each side of door in 1.0, 2.0 or 3.0 metre lengths
- * Complete with black EPDM Blade supplied continuous for each door
- * Easily compressed
- * Stops rubbish ingress
- * Stops water penetration
- Operating temperature range of -45 degrees C to +135 degrees C
 - (WILL NOT FREEZE)
 - New silicone sections , various colours including fluorescent orange
 - Can be steam cleaned
- TO ORDER MOQ 15 METRES , 3 WEEKS LEAD TIME

GEC Blok-Kade Blade & Blok-Kade Bubble

For example:

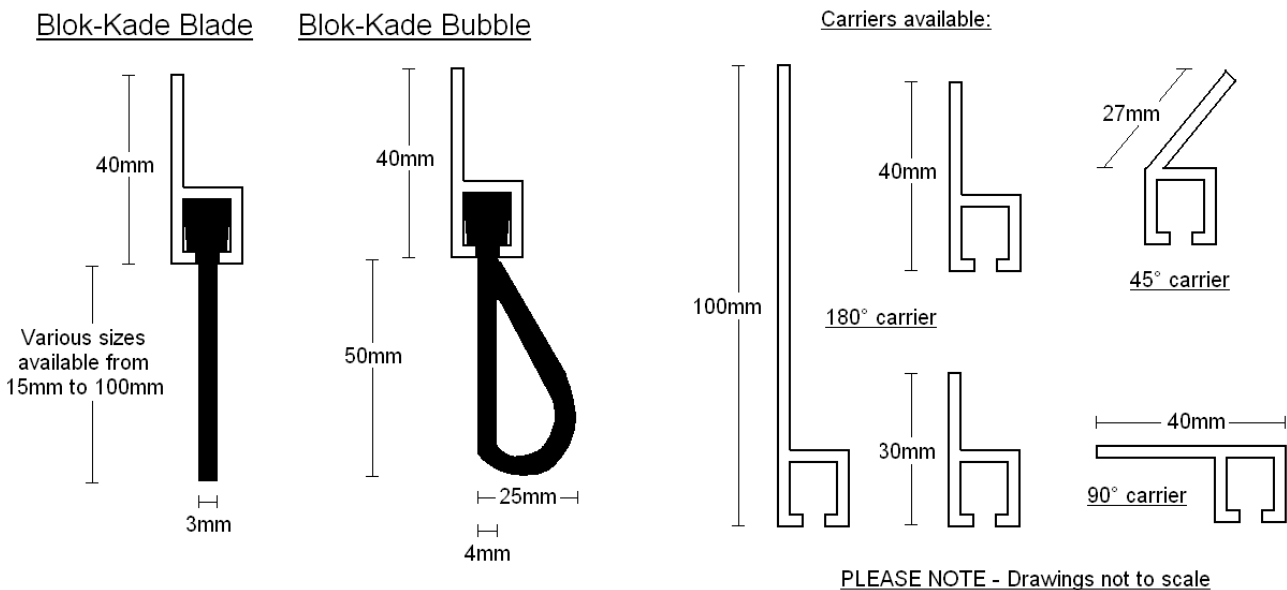

Blok-Kade Blade features:

- * This blade can be supplied in EPDM (Ethylene Propylene Diene Monomer)
- An elastomer which offers a wide range of application
- * It can also be supplied in white silicone (red, fluorescent orange, food grade blue, green or yellow silicone
Also available (subject to MOQ OF JUST 15 METRES) which can be steam cleaned and is
Ideal for high temperatures to 200°C
- * Seal consists of your specified blade in aluminium carriers supplied in 1.0, 2.0, 2.5 or 3.0 metre lengths
 - * Blade trim sizes: 15mm, 25mm, 30mm, 35mm, 40mm, 50mm, 60mm, 70mm, 80mm, 90mm
 - * Ideal for draughtproofing under soffits on industrial doors
 - * Scraper/wiper for conveyors
 - * Can be cut with a hand-knife to trim further
- * Operating temperature range of -45 degrees C to +135 degrees C (WILL NOT FREEZE)

Blok-Kade Bubble (VERY HEAVY DUTY) features:

- * The bubble is supplied in black EPDM in an aluminium carrier in 1.0, 2.0, 2.5 or 3.0 metre lengths
 - * Ideal for outward opening doors – butt joint each side
 - * Also works, bubble in reverse over opening of a double door.
 - * Fit to base of sectional doors
- * A very heavy duty, up and over garage door seal for the bottom, fit outside only

Flexibar 2000

Side skirt for conveyors

Can be used to create any angle with simple pipe clips

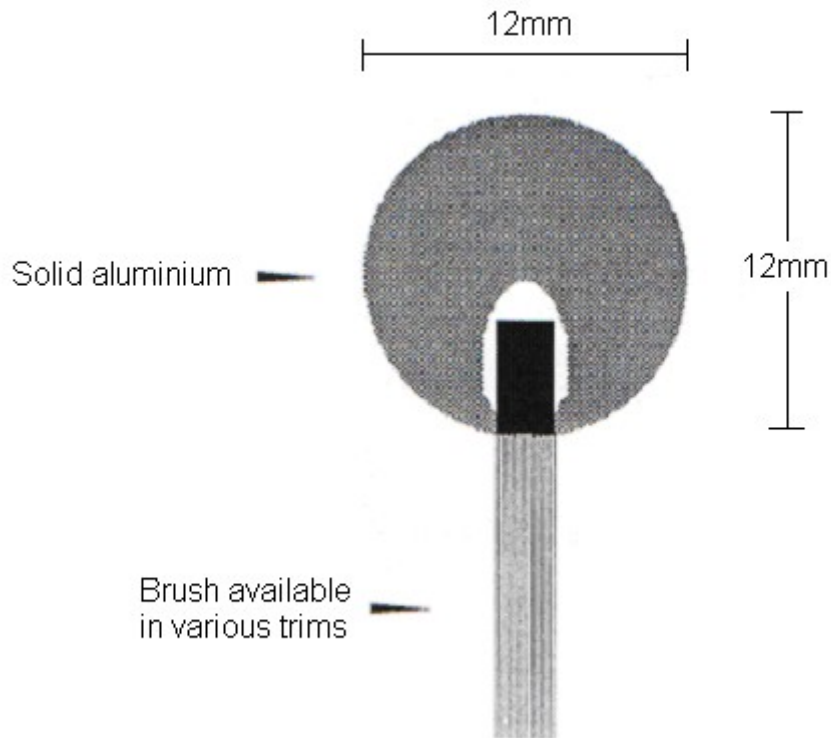

Features

- * Available in 1.0 or 2.0 metre lengths as standard
- * Solid Mill Finish Aluminium carrier extruded to BS1474
- * Can be used as a guide for supporting passing items
- * Proven with paint containers, PET bottles, plastic containers, on Air Conveyors etc
- * Available with 10mm, 15mm, 22mm, 25mm, 30mm, 35mm, 40mm, 45mm or 50mm trim black nylon brush
- * It can be rotated through 360 degrees and formed up to 90 degrees in Horizontal or vertical plane
 - * Soft flexible bristles of black nylon 6
 - Stability to 130 degrees C dry heat

There is a prize bottle of Brandy up for grabs for the best new application with Flexibar being used in SEPT – DEC 2010

Garage Door Seals

Rough sketch showing parts from elsewhere in this catalogue, used on a typical door sealing project

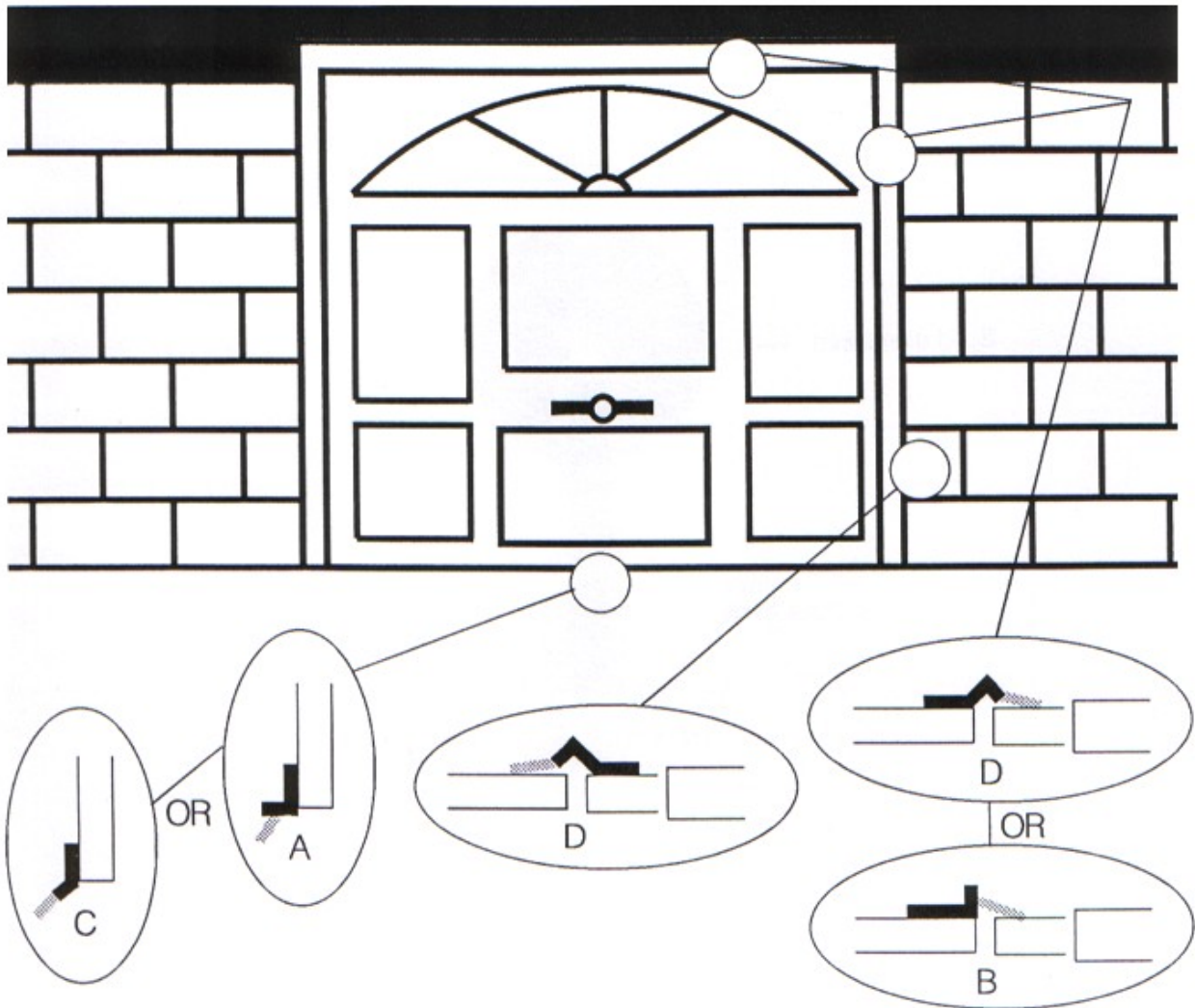

A. Aeroguard Perimeter Seal (18mm fixing leg) or Aeroguard Wide Perimeter Seal (23mm fixing leg), aluminium carrier incorporating a black angled EPDM rubber blade (approximately 15 or 22 mm), set at approximately 45 degrees. Aeroguard supplied in 0.89, 1.0, 1.5, 2.0, 2.1 or 3.0 metre lengths, Aeroguard Wide supplied in 0.89, 1.0, 1.5, 2.0, 2.1 or 3.0 metre lengths.

B. As above but with the EPDM rubber blade REVERSED. Please specify if you require the blade to be reversed at the time of ordering.

C. Premier 30, aluminium carrier angled at 30 degrees to allow the sides of the bristles to form a flexible seal. Suitable for flat or undulating surfaces. Available with brush trims of 10mm, 15mm, 22mm, 25mm, 30mm, 35mm, 40mm, 45mm and 50mm out of the carrier, supplied in 0.89, 1.0, 1.5, 2.0, 2.1 or 3 metre lengths.

D. Premier 55, as above but aluminium carrier angled at 55 degrees, supplied in 0.89,1.0, 1.5, 2.0, 2.1 or 3 metre lengths.

GEC Thermobubble, Black or White, can be extruded in other colours

Please note Thermobubble now has more of a diamond shape to give it a low closing force

ALSO AVAILABLE LOOSE COILED ON ITS OWN

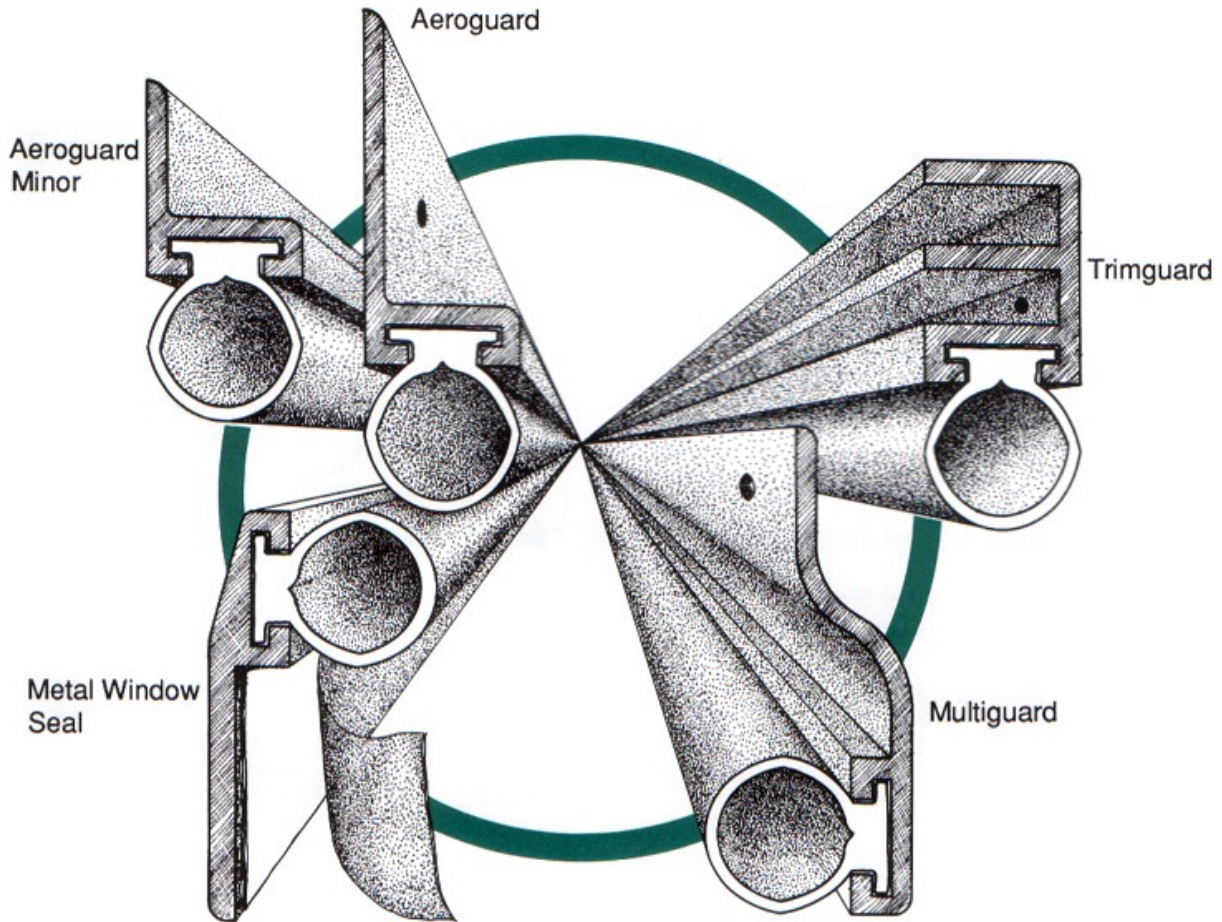

Features

- * **Silicone bubble available in white or black inserted into a wide variety of our carriers**

This silicone seal:

- * **Is completely resistant to ozone**
- * **Is resistant to UV light**
- * **Does not absorb water**
- * **Is resistant to weak acids and alkalis**
- * **Has excellent recovery characteristics**
- * **Has an excellent working temperature range of between -50 degrees C and +250 degrees C**
- * **Is unaffected by most known paints and stains**
- * **Allows seasonal movement up to 6mm**
 - * **Has a wipe clean surface**
 - * **Accommodates varying gaps**
- * **Has a low closing force – easily compressed**
- * **Supplied with appropriate fixings**
- **Larger bubble for temperatures of up to +300 degrees C available**

SEE OTHER SILICONE SEALS IN OUR RUBBER CATALOGUE

GEC Thermobubble

APPLICATIONS

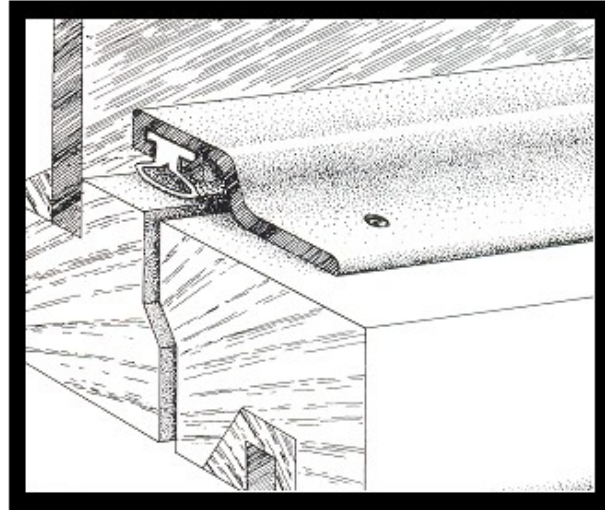
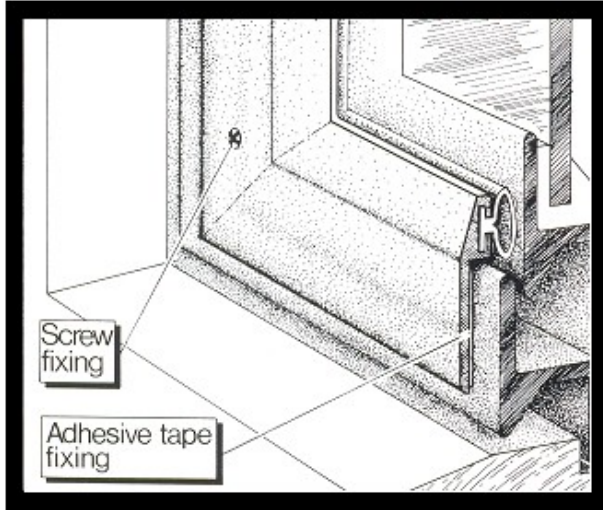

Metal Window Seal:

Accommodates uneven gaps from 0mm-6mm Created by twisted frame. Not recommended for hinge face. Use Metal Window Seal with 5mm/6.5mm polypropylene pile on hinge face. Refer to Metal Window Seal leaflet for full fixing instructions.

Multiguard:

Illustration shows sealing of meeting rail of sliding rail of sliding sash window to accommodate gap created by drop of up to 4mm in inner sash. Refer to Multiguard (Centre Rail Seal) leaflet for full fixing instructions.

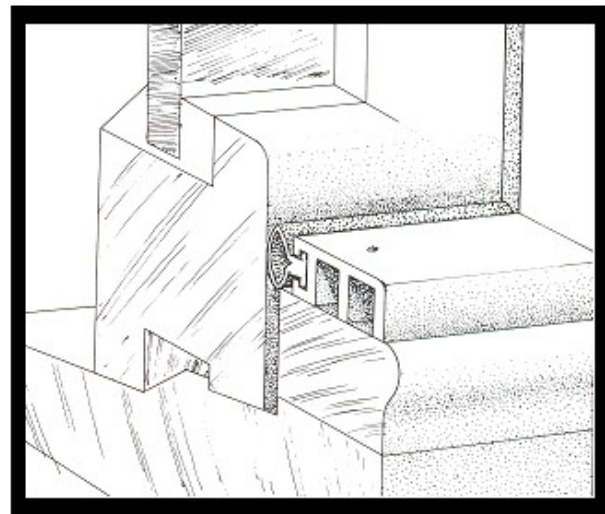
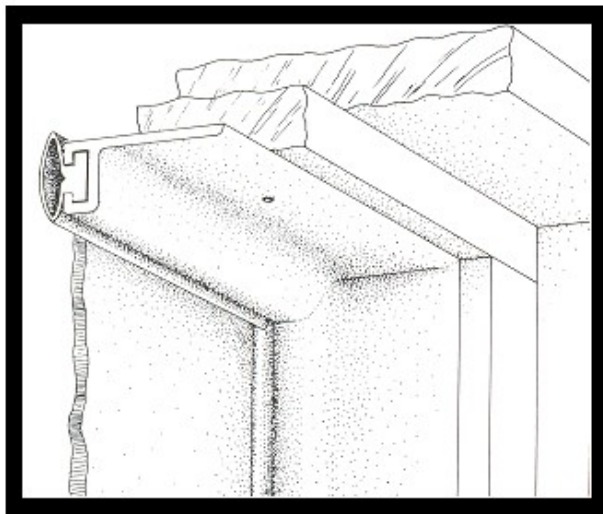

Aeroguard/Aeroguard Minor:

Aeroguard Thermobubble for door application allows for sealing of gaps up to 10mm. Aeroguard Minor will seal gaps up to 6mm. Refer to Aeroguard/Aeroguard Minor leaflet for full fixing instructions.

Trimguard:

Accommodates seasonal movement of timber windows/doors of up to 6mm. Refer to Trimguard Perimeter Seal leaflet for full fixing instructions.

ALSO AVAILABLE LOOSE FOR OEM APPLICATIONS OR AS A REPLACEMENT WINDOW SEAL

GEC Angled EPDM Blades and Straight Silicone Blades (Not to scale)

15mm Angled EPDM Blade

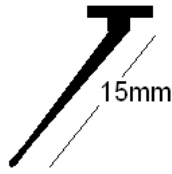

22mm Angled EPDM Blade

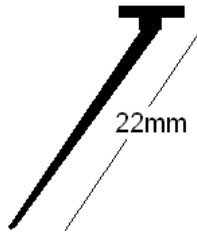

10mm Silicone Blade



20mm Silicone Blade

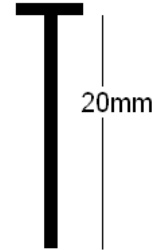

The above seals will fit into any of our carriers as follows:

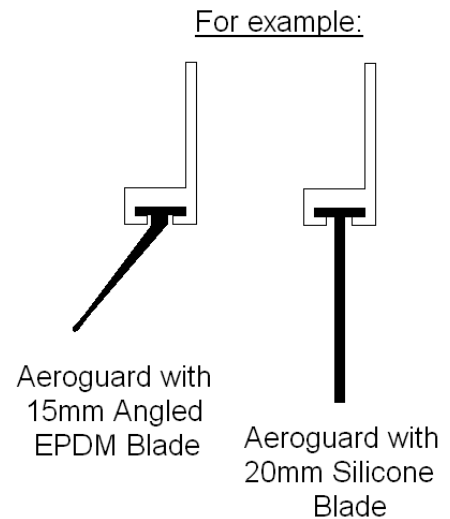
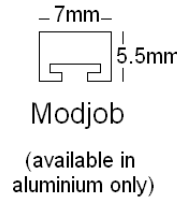
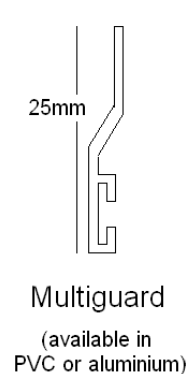
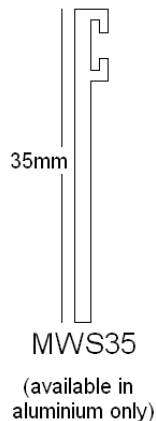
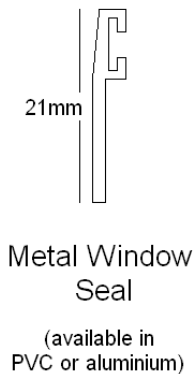
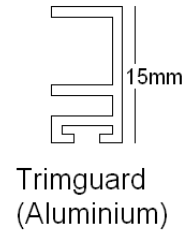
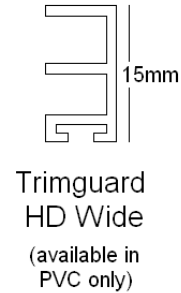
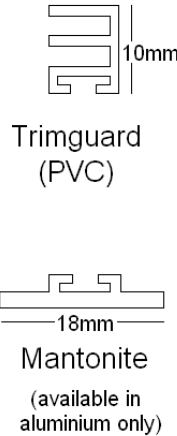
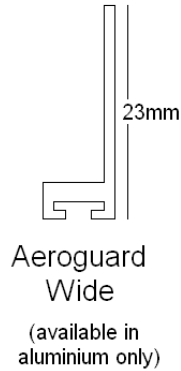
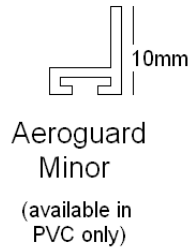
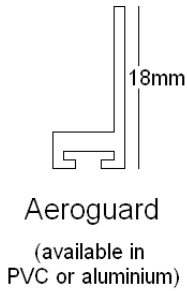

Features

- * Seal consists of your specified carrier and 10mm or 20mm Straight Silicone Blade or 15mm or 22mm black angled EPDM Blade as required
- * Aluminium carriers can be pop-riveted or screwed into place, supplied pre-drilled for acceptance of screws or can be supplied with double-sided self-adhesive tape
- * PVC carriers can be pinned into place or can be supplied with double-sided self-adhesive tape
- * EPDM Blade has an operating temperature range of -30 degrees C to + 80 degrees C
- * Silicone Blade has an operating temperature range of -50 degrees C to +220 degrees C
- * Permanent flexible seal – remains soft
- * Soft scraper/wiper for conveyors
- * Can be used to seal shower doors
- * Ideal for draughtproofing garage doors
- * Cable management (use in pairs)

GEC Metal Window Seal

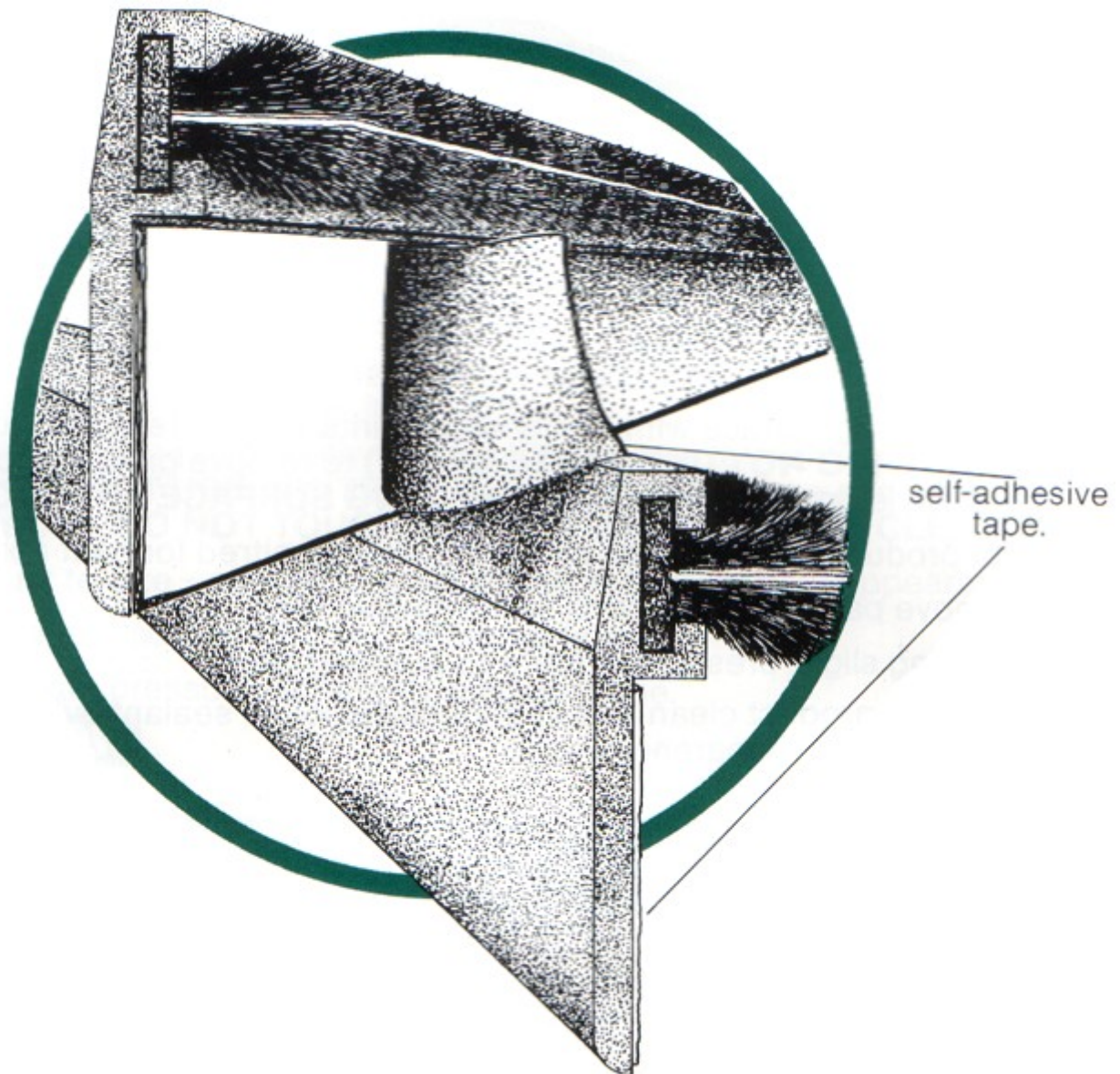

Features

- * Carrier available in various finishes, white PVCu, grey or brown PVC, standard aluminium and satin, black, bronze or matt gold anodised or white painted aluminium to order
- * PVC carriers incorporate strong, light and age resistant acrylic self-adhesive tape for fixing
 - * Dimensionally stable – will not rot, shrink or swell
 - * PVC carriers supplied in 2.1 metre lengths
- * Aluminium carriers supplied in 0.89, 1.0, 1.5, 2.0, 2.1 and 3 metre lengths

Available with the following inserts

- * Grey, white or black, silicone treated, polypropylene pile incorporating central fin with pile heights of 5mm, 6.5mm, 8.5mm, 10mm, 12mm and 15mm (black, grey or white)
 - * White or black Thermobubble
 - * White Sheathed Blade
 - * 15mm or 22mm angled Black EPDM Blade
 - * 10mm or 20mm straight Black Silicone Blade
 - * Turbo-Seal
- IF HIGH TEMPERATURE 200 DEGREEEC PLUS :
 - High Temperature Bubble (recommended for use with aluminium carriers only)

ALL INSERTS ARE AVAILABLE

GEC Metal Window Seal

FIXING INSTRUCTIONS FOR WINDOWS IN POOR CONDITION

PLEASE FOLLOW CAREFULLY

1. Metal Window Seal should be applied to a window frame with pile touching against closing window. Window should be closed during application.
2. Using the table below for guidance, select the correct sized pile height for the maximum gap to be sealed. NB – TOO HIGH A PILE HEIGHT WILL RESULT IN THE PRODUCT BEING FORCED FROM THE WINDOW.
3. Using a chisel, remove any loose/flaky paint and lumps from the fixing surface and score with coarse sandpaper.
4. Clean fixing surface with methylated spirits, carbon tetrachloride or acetone (DO NOT USE WHITE SPIRIT) to remove grease and ensure surface is dry. DO NOT TOUCH FIXING SURFACE AFTER CLEANING.
5. Cut product to size – each corner should be mitred for neat appearance.
6. Remove paper backing from self-adhesive tape.
7. Applying slight pressure, adhere to window frame.

OPEN WINDOW

8. Using a power drill (AT LOW SPEED) with a 3.2mm or 1/8in high speed drill bit, drill through the fixing leg of the product and the frame together where a screw is required. It is recommended that the product be screw fixed at 175mm centres with a fixing within 25mm of each end.
9. Using a POZI Drive (No 2) screwdriver apply the No 6, 1/4 in self tapping screws with a 'B' point (as supplied) and screw in position. DO NOT OVER TIGHTEN
10. Wipe the product clean and apply silicone sealant over the mitred joints or tidy appearance.
11. CLEAR ALL MESS FROM SITE

RECOMMENDED PILE HEIGHTS

For gaps:	Pile height: 5mm	6.5mm	8.5mm	10mm	12mm	15mm
1.0 – 2.5mm	*					
2.5 – 4.0mm		*				
4.5 – 6.0mm			*			
6.0 – 7.5mm				*		
7.5 – 9.0mm					*	
9.0 – 10.5mm						*

GEC Trimguard Perimeter Seal

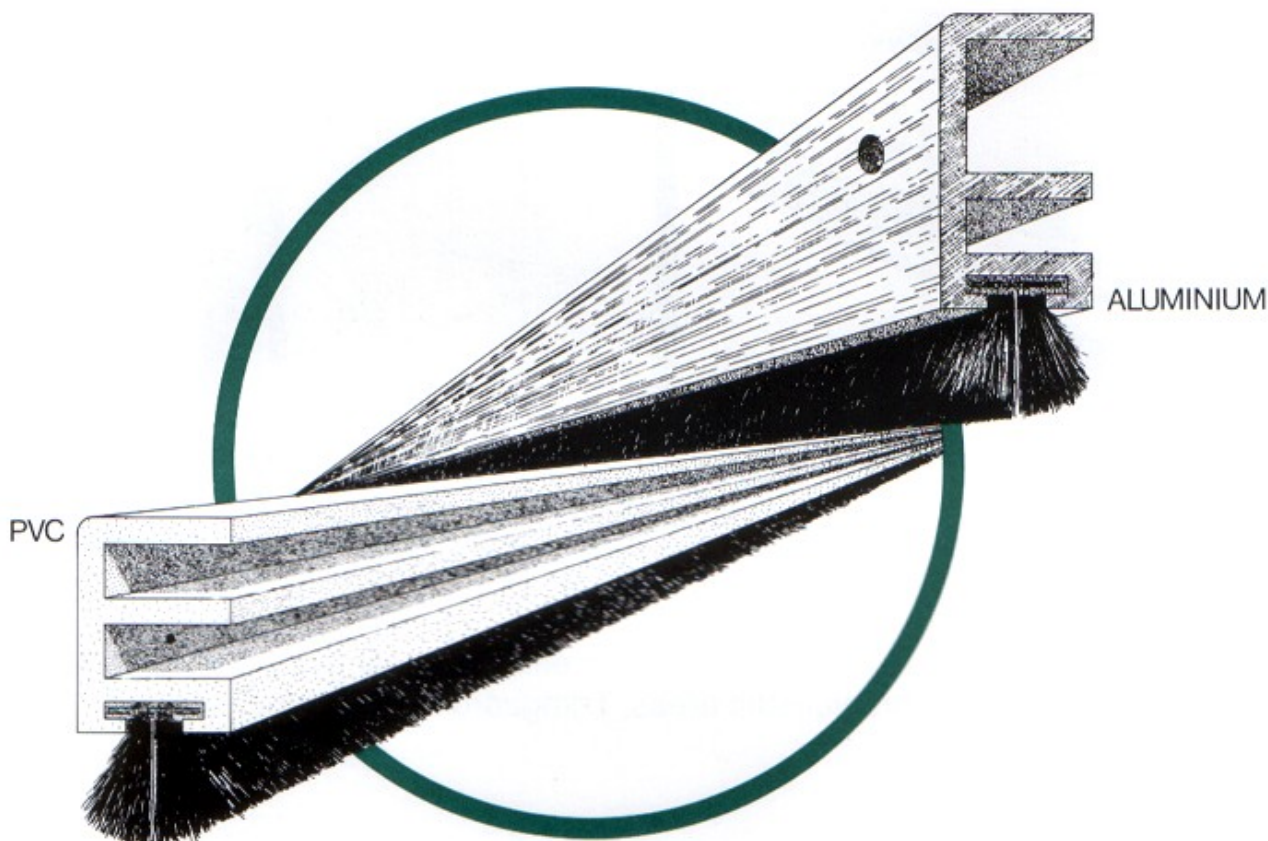

Features

- * Carrier available in various finishes, white PVCu, brown or black PVC, standard aluminium and satin, black, bronze or matt gold anodised or white painted aluminium to order
- * PVC section ideal for use on slimline or curved beadings around sash windows - eliminates rattling and draughts
 - * All carriers supplied in 2.1 metre lengths
 - * Dimensionally stable – will not rot, shrink or swell
 - * Resists UV and ozone degradation
- * All PVC sections fabricated for pin fix and supplied with stainless steel pins
- * Aluminium sections fabricated for screw fix and supplied with zinc plated steel screws

Available with the following inserts

- * Grey, white or black, silicone treated, polypropylene pile incorporating central fin with pile heights of 5mm, 6.5mm, 8.5mm, 10mm, 12mm and 15mm (black, grey or white)
 - * White or black Thermobubble
 - * White Sheathed Blade
 - * 15mm or 22mm angled Black EPDM Blade
 - * 10mm or 20mm straight Black Silicone Blade
 - * Turbo-Seal
- * High Temperature Bubble (recommended for use with aluminium carriers only)

GEC Trimguard Perimeter Seal

APPLICATIONS

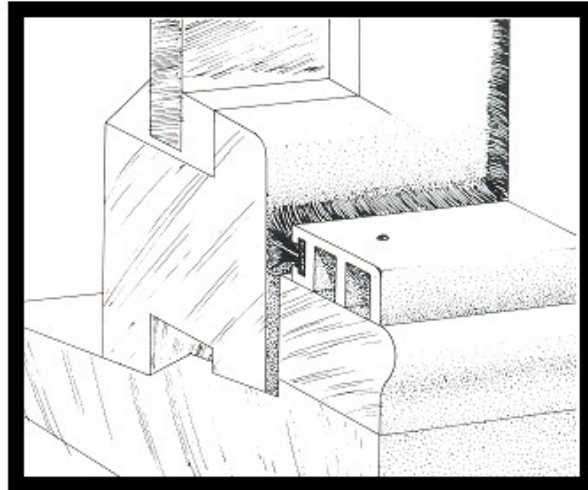
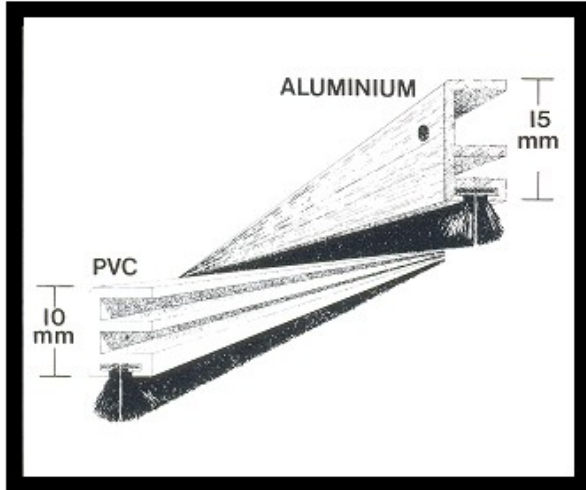

Although Trimguard has been specifically designed to overcome the problem of draught-proofing sash windows, it can be effectively used on most door/window applications.

The 6.5mm pile fitted as standard provides efficient sealing of gaps up to 15mm. For those particular problematic areas, Trimguard can be supplied with pile heights of up to 15mm.

FIXING INSTRUCTIONS

DOORS/CASEMENT WINDOWS

1. Trimguard should be fitted to the door/window frame with door/window in a closed position.
2. Measure length required and cut PVC carrier with Rolcut cutters and aluminium carrier with a fine tooth hacksaw.
3. Butt Trimguard up against corner of door/window, apply slight pressure towards opening frame and pin/screw in position.
4. Butt-joint all corners for a neat appearance.

SLIDING SASH WINDOWS

1. Trimguard should be fitted whilst window is in closed position.
2. Trimguard is fitted internally around lower sash and externally around upper sash.
3. Follow steps 2-4 above.

Trimguard is available in the same pile/carrier combinations as Multiguard (Centre Rail Seal) –
The complete answer to draughty sash windows.

GEC Multiguard (Centre Rail Seal)

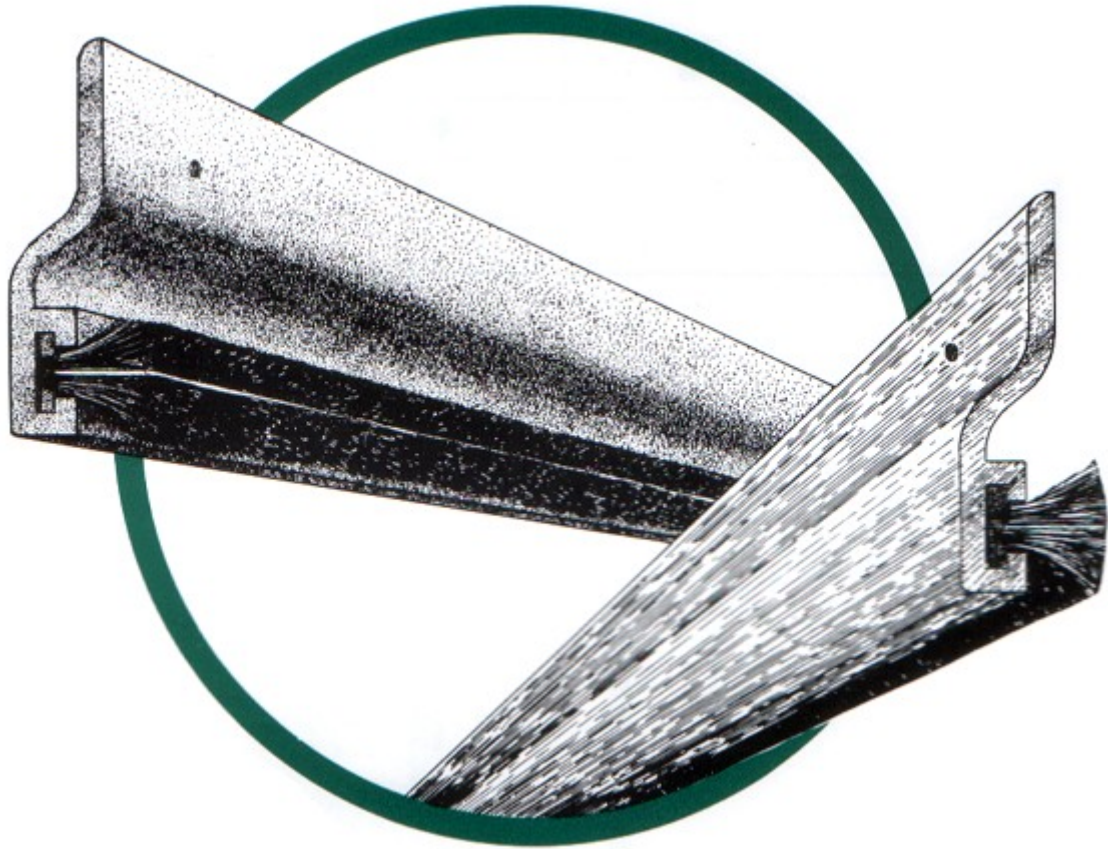

Features

- * Carrier available in various finishes – white PVCu, brown or black PVC, standard aluminium and satin, black, bronze or matt gold anodised or white painted aluminium to order
 - * Dimensionally stable – will not rot, shrink or swell
 - * Resists UV and ozone degradation
- * All PVC sections fabricated for pin fix and supplied with stainless steel pins
- * Aluminium sections fabricated for screw fix and supplied with zinc plated steel screws
 - * All sections supplied in 2.1 metre lengths

Available with the following inserts

- * Grey, white or black, silicone treated, polypropylene pile incorporating central fin with pile heights of 5mm, 6.5mm, 8.5mm, 10mm, 12mm and 15mm (black, grey or white)
 - * White or black Thermobubble
 - * White Sheathed Blade
 - * 15mm or 22mm angled Black EPDM Blade
 - * 10mm or 20mm straight Black Silicone Blade
 - * Turbo-Seal
- * High Temperature Bubble (recommended for use with aluminium carriers only)

Multiguard (Centre Rail Seal)

RECOMMENDED PILE HEIGHTS

Gap size	Pile height 6.5mm	8.5mm	10mm	12mm	15mm
0 - 2mm	*				
1.5 - 4mm		*			
3.5 - 5.5mm			*		
5 - 7.5mm				*	
7 - 10.5mm					*

APPLICATIONS

Single action swing doors/certain style pivot windows.

Timber sash windows.

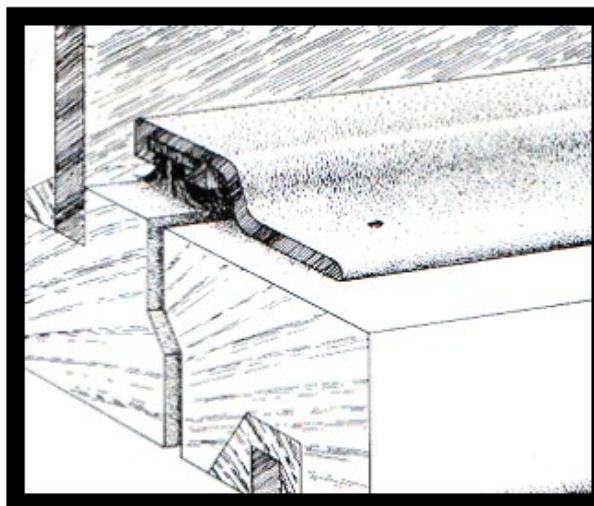
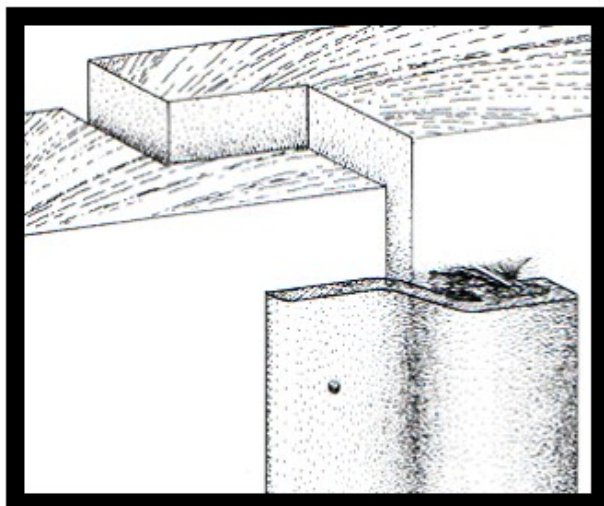

FIXING INSTRUCTIONS

1. Cut to size using Rolcut cutters or hacksaw.
2. Pin or screw in position.

Multiguard (Centre Rail Seal) is available in the same pile/carrier combinations as Trimguard –
The complete answer to draughty sash windows.

ALTERNATIVE METHOD WITH VERTICAL GLAZING BARS

ASK FOR A SAMPLE OF AEROGUARD BUFFER AND USE IT WITH AEROGUARD OR TRIMGUARD

GEC Aeroguard Perimeter Seal incorporating GEC Aeroguard Minor

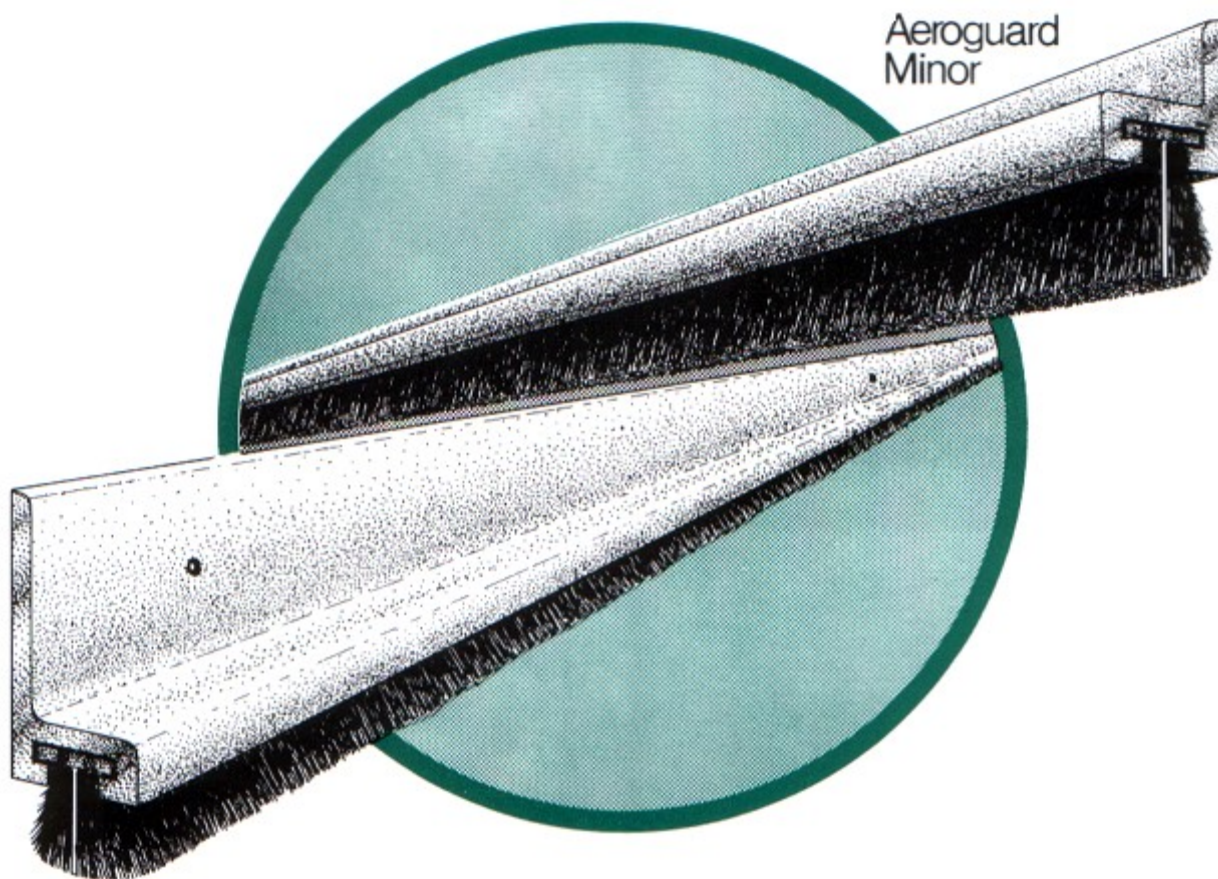

Features

- * Aeroguard available in various finishes – white PVCu, brown or black PVC, standard aluminium and Satin, black, bronze or matt gold anodised or white painted aluminium to order
 - * Aeroguard Minor available in white PVCu, brown or black PVC carrier only
- * PVC, anodised and white painted aluminium carriers available in 2.1 metre lengths
- * Mill finish aluminium carriers supplied in 0.89, 1.0, 1.5, 2.0, 2.1 metre or 3 metre lengths
 - * Aeroguard Minor supplied in 2.1 metre lengths
- * All PVC sections fabricated for pin fix and supplied with solid brass escutcheon pins
- * Aluminium sections can be fabricated for screw fix and supplied with zinc plated steel screws

Available with the following inserts

- * Grey, white or black, silicone treated, polypropylene pile incorporating central fin with Pile heights of 5mm, 6.5mm, 8.5mm, 10mm, 12mm and 15mm (black, grey or white)
 - * White or black Thermobubble
 - * White Sheathed Blade
- * 15mm or 22mm angled Black EPDM Blade
- * 10mm or 20mm straight Black Silicone Blade
- * Turbo-Seal
- * High Temperature Bubble (recommended for use with aluminium carriers only)

MANY COMBINATIONS NOT LISTED, ENDLESS CHOICES

Aeroguard & Aeroguard Minor

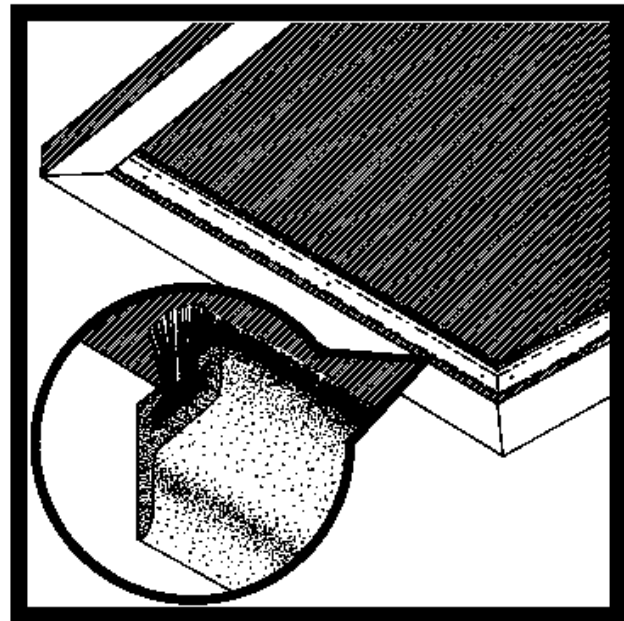
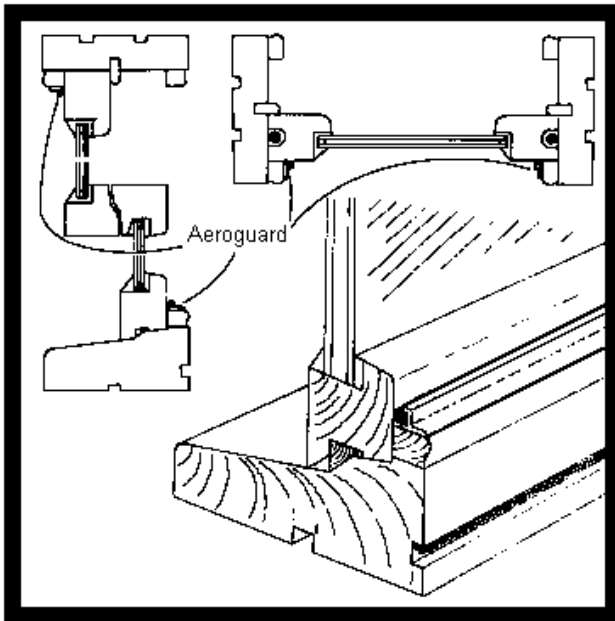
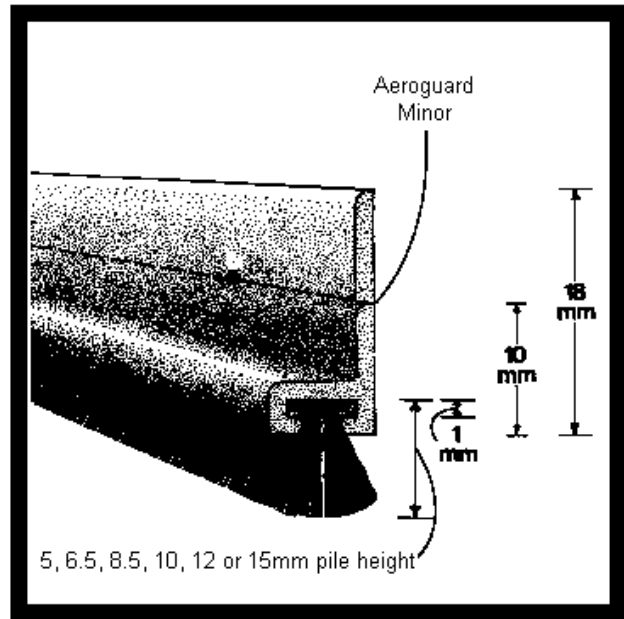
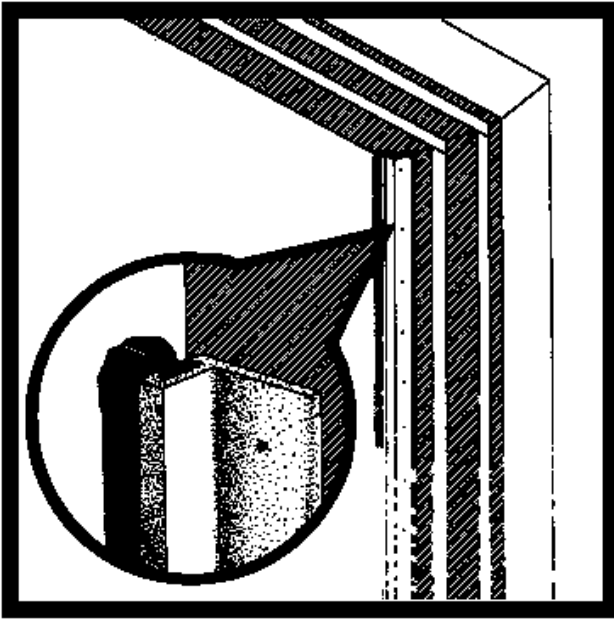

FIXING INSTRUCTIONS

1. Aeroguard should be applied to a window/door/loft hatch in a closed position.
2. Measure length required and cut aluminium with a fine tooth hacksaw and PVC with Rolcut cutters.
3. Butt Aeroguard up against corner of window/door/loft hatch; apply slight pressure towards opening frame and pin/screw/staple in position.
4. Mitre all corners for neat appearance, or scribe into previous fitted piece of Aeroguard
5. CLEAR OFFCUTS AND RUBBISH FROM SITE

WHEN DRAUGHT PROOFING A DOOR, ALWAYS FIT THE TOP PART OF DRAUGHT PROOFING FIRST, THEN FIT THE SIDES UP TO THE AEROGUARD, CUTTING IN TO FIT IT LOOKS BETTER VISUALLY THIS WAY ROUND

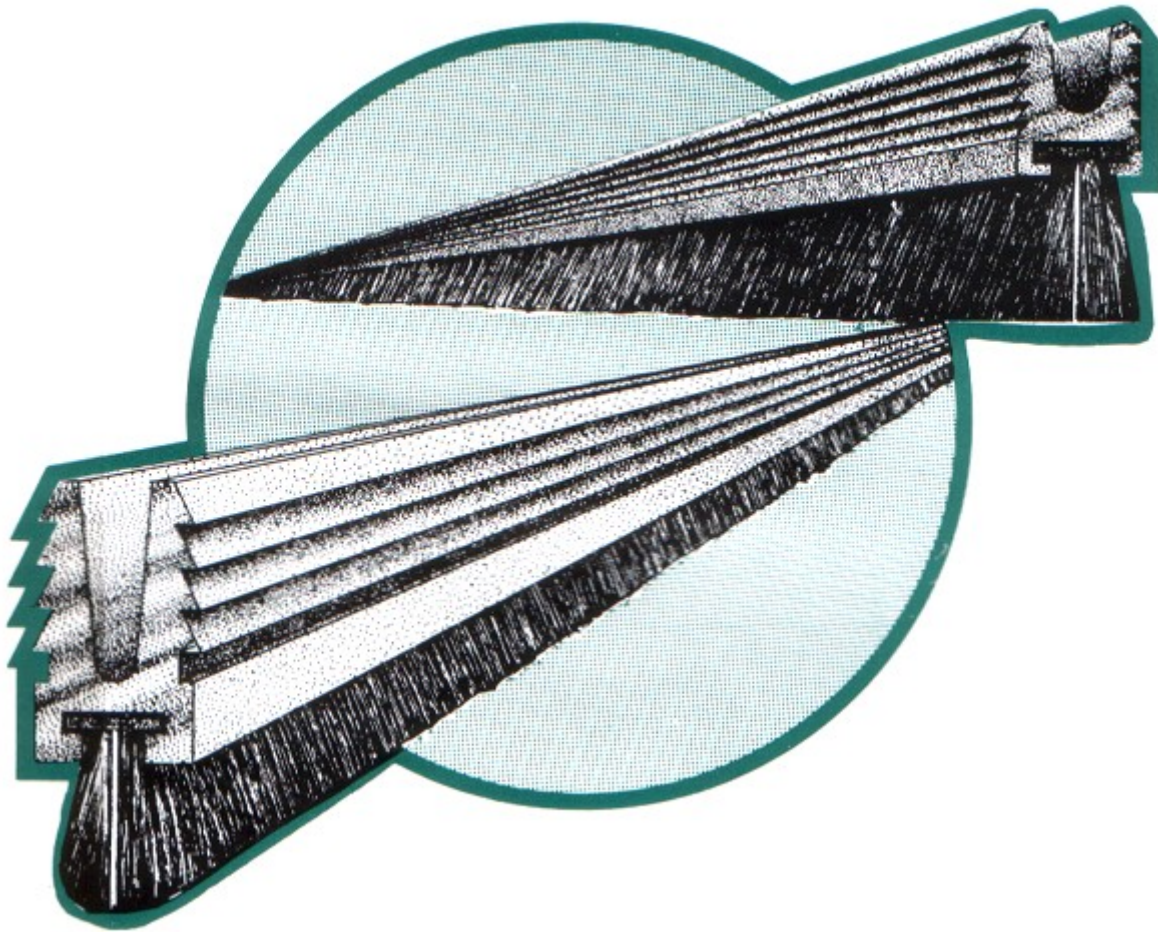
GEC Molar (Major & Minor)**Features**

- * Molar Major groove size 8mm wide x 16mm deep
- * Molar Minor groove size 6.3mm wide x 9mm deep
- * Carrier available in brown or black PVC or white PVCu
 - * Barbs ensure installation is permanent
- * More than a draught excluder – also a cold smoke Seal
- * Ideal for double/single action swing doors and will give a high performance seal on timber patio doors
 - * Supplied in 2.1 metre lengths

Available with the following inserts

- * Grey, white or black, silicone treated, polypropylene pile incorporating central fin with pile heights of 5mm, 6.5mm, 8.5mm, 10mm, 12mm and 15mm (black, grey or white)
- * White or black Thermobubble
- * White Sheathed Blade
- * Turbo-Seal
- * 15mm or 22mm angled Black EPDM Blade
- * 10mm or 20mm straight Black Silicone Blade

GEC Molar Major & Minor

RECOMMENDED PILE HEIGHTS – MOLAR MAJOR

For gaps:	Pile height: 5mm	6.5mm	8.5mm	10mm	12mm	15mm
1.0 – 3mm	*					
2.5 – 4.5mm		*				
4.5 – 6.5mm			*			
6 - 8mm				*		
8 – 9.5mm					*	
9 – 10.5mm						*

RECOMMENDED PILE HEIGHTS – MOLAR MINOR

For gaps:	Pile height: 5mm	6.5mm	8.5mm	10mm	12mm	15mm
1.5 – 3.5mm	*					
3 - 5mm		*				
5 - 7mm			*			
6.5 – 8.5mm				*		
8.5 - 10mm					*	
9.5 – 11.5mm						*

TYPICAL APPLICATIONS

For gaps in excess of 10mm – halve gap size and using the table above select appropriate pile height for Major section which will give added strength and rigidity. One section should then be fitted into each leaf of timber, one to meet the other, for example:

12mm gap size - two pieces of Major, 8.5mm
15mm gap size - two pieces of Major, 10mm
18mm gap size - two pieces of Major, 12mm

FIXING INSTRUCTIONS

1. Route appropriate groove size down centre of timber leaf.
2. Cut plastic section to size and mitre as necessary.
3. Tap plastic section into groove.
4. Cut pile to size and draw through channel in plastic section.
5. It is recommended that a small blob of glue be inserted into either end of the plastic channel to hold pile in position.

BUBBLE & FLIPPER GASKET SECTIONS



R3444
BUBBLE



R3575
DUPLEX BUBBLE



R4425X
BUBBLE /
FLIPPER



R5019X
BUBBLE



R6053X
BUBBLE



R6064X
BUBBLE



R6160
BUBBLE



R6391X
BUBBLE



R6419X
BUBBLE



R6484X
BUBBLE



R6497X
BUBBLE /
FLIPPER



R6598
BUBBLE



R6679
BUBBLE



R9007
DUPLEX
BUBBLE



R9058
BUBBLE /
FLIPPER



R9160X
CORDED
BUBBLE



R9260
DUPLEX
BUBBLE



R9436X
LOW LINE
BUBBLE



R9445X
BUBBLE



R9566
FOAM BUBBLE



R4055X
FLIPPER



R4754X
FLIPPER



R6066
FLIPPER



R6381X
FLIPPER



R6407X
FLIPPER



R6418X
FLIPPER



R6480
FLIPPER



R6527X
FLIPPER



R6619X
FLIPPER



R6809X
FLIPPER



R6904
FLIPPER



R9010X
FLIPPER



R9079X
CORDED
FLIPPER



R9114
FLIPPER

E GASKET SECTIONS



R4124X
EXTERNAL

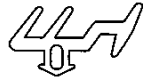

R4620X
EXTERNAL



R5344
DUPLEX
EXTERNAL



R5711
EXTERNAL

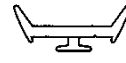

R6068
DUPLEX
EXTERNAL



R6132X
CORDED
EXTERNAL



R6344X
CORDED
EXTERNAL



R6346X
EXTERNAL



R6377
DUPLEX
EXTERNAL



R6499X
CORDED LOW LINE
EXTERNAL



R6500X
CORDED
EXTERNAL



R9565X
FLIPPER



R6543X
CORDED
EXTERNAL



R6549X
CORDED
EXTERNAL



R6563
CORDED
EXTERNAL

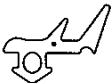

R6603
CORDED
EXTERNAL



R6608
LOW LINE
EXTERNAL



R6652X
EXTERNAL



R6687X
CORDED
EXTERNAL



R6935X
DUPLEX SPONGE
EXTERNAL



R9021X
CORDED
EXTERNAL



R9032X
CORDED
LOW LINE



R9045X
LOW LINE
EXTERNAL



R9046X
CORDED
LOW LINE



R9070X
LOW LINE
EXTERNAL



R9098
WHITE FACED
EXTERNAL



R9110X
CORDED
EXTERNAL

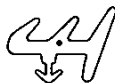

R9156X
CORDED
EXTERNAL

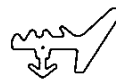

R9158X
CORDED
EXTERNAL



R9214X
CORDED
WEDGE



R9222X
CORDED
EXTERNAL



R9228
CORDED
EXTERNAL



R9251X
CORDED
LOW LINE



R9259
DUPLEX
EXTERNAL



R9334
WHITE CAPPED
EXTERNAL

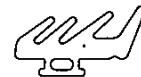

R9082X
CORDED
EXTERNAL

WEDGE GASKET SECTIONS



R3232
4.6mm
WEDGE



R3235
3.0mm
WEDGE



R3236
2.6mm
WEDGE



R3360
7.2mm
WEDGE



R3412
4.0mm
CORDED WEDGE



R6513
3.0mm
CORDED WEDGE



R6071
DUPLEX
TEAR-OFF
WEDGE



R6152X
CORDED
TEAR-OFF
WEDGE



R6201X
CORDED
TEAR-OFF
WEDGE



R6232X
CORDED
TEAR-OFF
WEDGE



R6503
3.5mm
CORDED
WEDGE



R6515
5.0mm
CORDED
WEDGE



R3413
3.5mm
CORDED
WEDGE



R4897
DUPLEX
TEAR-OFF
WEDGE



R5536
DUPLEX
TEAR-OFF
WEDGE



R5913
CORDED
WEDGE



R9227
CORDED
WEDGE



R6631
DUPLEX
TEAR-OFF
WEDGE

T-FOAMSEAL SECTIONS



R3006
WEDGE



R3007
BUBBLE



R9525
FLIPPER

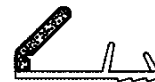

R3009
FLAT FLIPPER



R9588
BUBBLE

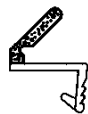

R3008
ANGLED FLIPPER



R9614
BUBBLE

MISCELLANEOUS GASKET SECTIONS



R6725
U-CHANNEL



R6771X
7mm MULLION
GASKET

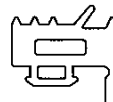

R6778X
6mm TRANSOM
GASKET



R9377X
MID RAIL
SEAL

FRIDGE SEALS

MG-1



8 x 3.5mm Magnet

MG-2



8 x 3.5mm Magnet

MG-3



8 x 3.5mm Magnet

MG-4



8 x 3.5mm Magnet

MG-5

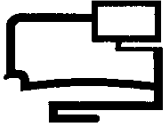

8 x 3.5mm Magnet

MG-6



8 x 3.5mm Magnet

MG-7



8 x 3.5mm Magnet

MG-7A

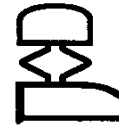

MG7-A forms the hinge side of a seal/gasket where the other three sides use MG-7.

MG-8



9.8 x 3.1mm Magnet

MG-9



8 x 3.5mm Magnet

MG-10



9.8 x 3.1mm Magnet

MG-11



8 x 3.5mm Magnet

MG-12



9.8 x 3.1mm Magnet

MG-12A



MG-12A forms the hinge side of a seal/gasket where the other three sides use MG-12.

MG-13



Incorporates Tri-Pole Magnet.
9.8 x 3.1mm Magnet

MG-14



9.8 x 3.1mm Magnet

MG-15



9.8 x 3.1mm Magnet

MG-16



9.8 x 3.1mm Magnet

MG-17



8 x 3.5mm Magnet

MG-18



9.8 x 3.1mm Magnet

MG-19



8 x 3.5mm Magnet

MG-20



8 x 3.5mm Magnet

MG-22

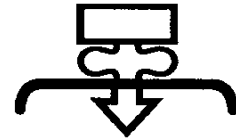

11.5 x 3.2mm Magnet

COMPRESSION SEALS

CG-1



CG-2



CG-3



CG-4

EO



CG-5



CG-6



CG-7



CG-8



CG-9



CG-10



CG-11



CG-12

EO

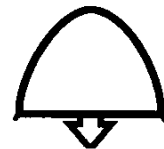

CG-13

EO



CG-14

EO

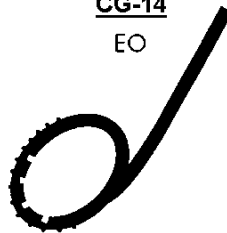

CG-15

EO



RUBBER & PLASTIC COMPRESSION SEALS (1)

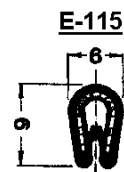
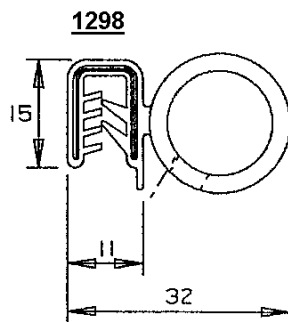
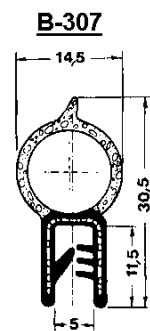
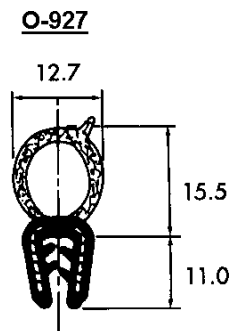
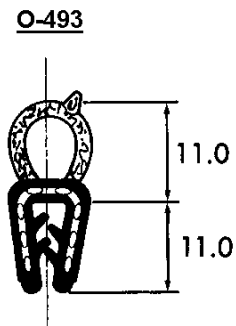
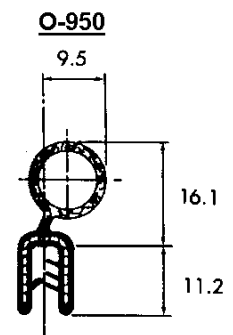
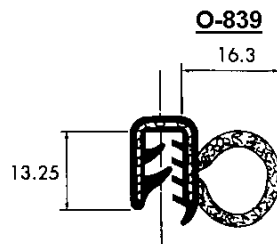
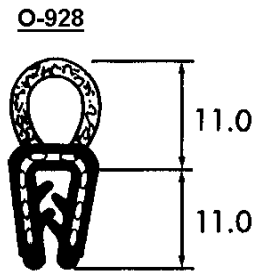
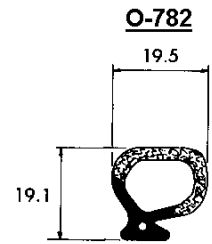
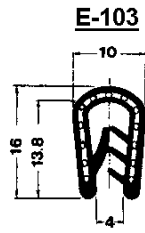
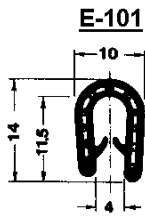

RUBBER & PLASTIC COMPRESSION SEALS (2)

F-152

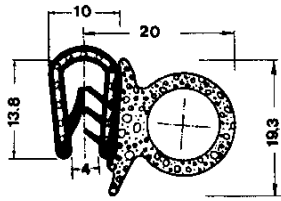

O-106

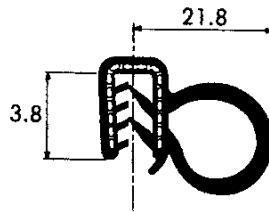

O-150

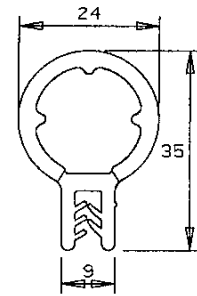

O-940

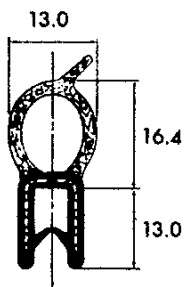

O-753

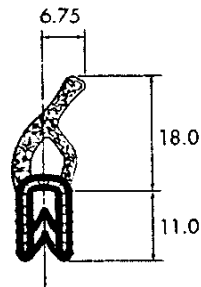

O-763

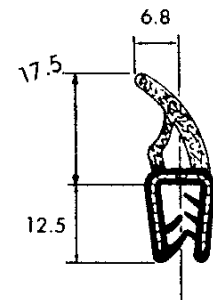

O-924

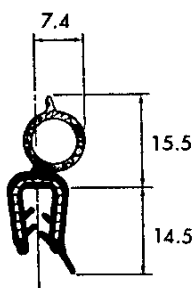

S-914

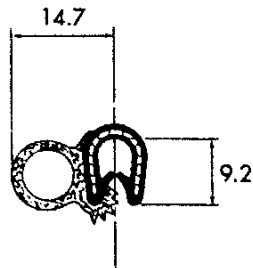

O-603

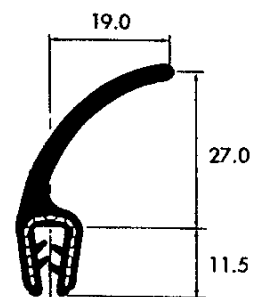

O-176

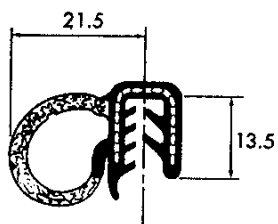

O-455

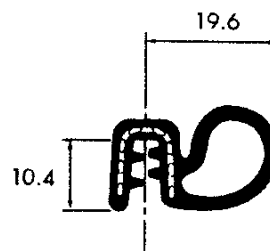

T-Foam seals

A range of door and casement window weatherseals with ultra-high performance designed in. Suitable for all timber applications, T-Foamseals are unobtrusive when fitted and highly resistant to wear.

- * Lifetime guarantee
- * Excellent deflection recovery
- * Outer skin impervious to paint and stain
- * High performance over a wide temperature range
- * Closed-cell foam will not absorb water
- * Low friction skin
- * Will not shrink or stretch
- * Puncture 'self-sealing'
- * Rigid foot for fast insertion
- * Will not freeze to contact surfaces
- * Not affected by mildew, mould or rot
- * UV and ozone stable
- * CFC-free

TFS06 Wedge

Description	Colour	MOQ
TFS06 Wedge	Brown	20 metres
TFS06 Wedge	White	20 metres

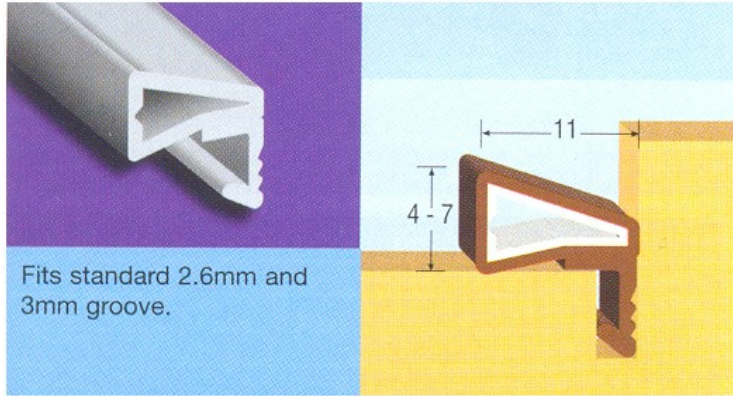

TFS06 Wedge

TFS07 Bubble

Description	Colour	MOQ
TFS07 Bubble	Brown	20 metres
TFS07 Bubble	White	20 metres

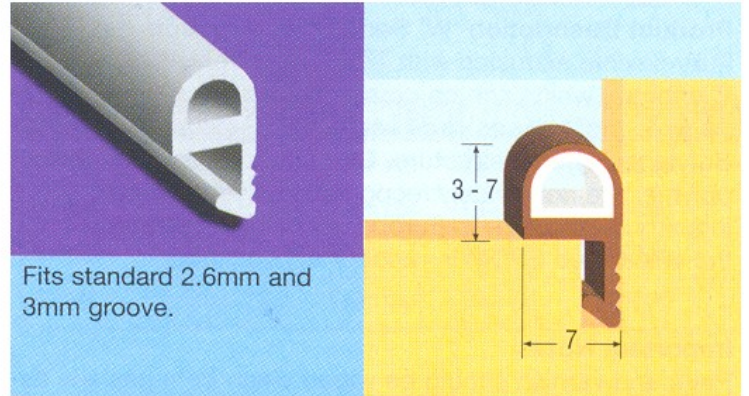

TFS07 Bubble

TFS08 Angled Flipper

Description	Colour	MOQ
TFS08 Angled Flipper	Brown	20 metres
TFS08 Angled Flipper	White	20 metres

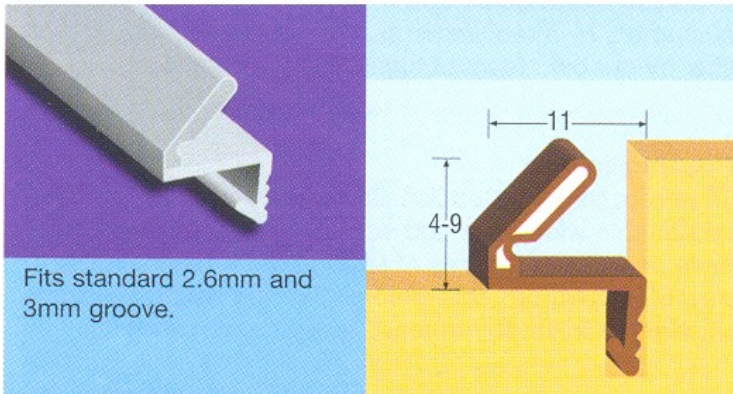

TFS08 Angled Flipper

TFS09 Flat Flipper

Description	Colour	MOQ
TFS09 Flat Flipper	Brown	20 metres
TFS09 Flat Flipper	White	20 metres

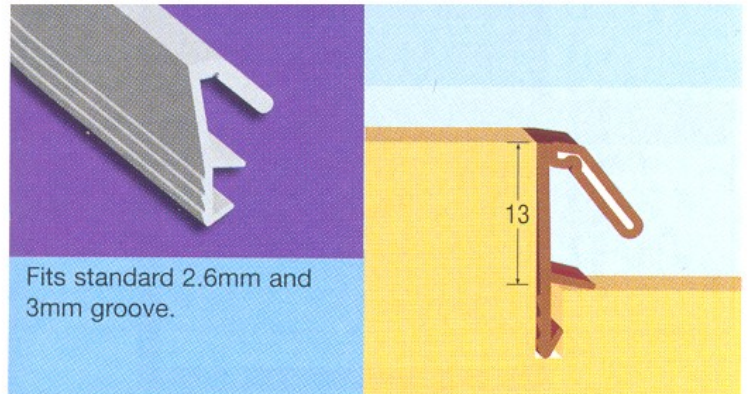

TFS09 Flat Flipper

Weather seals

F-Series Flipper Weather seals

Excellent recovery. Durable and UV stable. Non-stretch and non-shrink. Compatible with solvent and water-based finishes.

Description	Height	Colour	MOQ	Description	Height	Colour	MOQ
F10 Flat Flipper	10mm	Brown	TBA	F16 Flat Flipper	16mm	White	TBA
F12 Flat Flipper	12mm	Brown	TBA	F18 Flat Flipper	18mm	Brown	TBA
F12 Flat Flipper	12mm	White	TBA	F18 Flat Flipper	18mm	White	TBA
F15 Flat Flipper	15mm	Brown	TBA	F20 Flat Flipper	20mm	Brown	TBA
F15 Flat Flipper	15mm	White	TBA	F20 Flat Flipper	20mm	White	TBA
F16 Flat Flipper	16mm	Brown	TBA				

W-Series Weather seals

Fully flexible TPE (Thermoplastic Elastomer) weather seal which can be corner welded. A Range of Flipper and bubble profiles to suit a variety of applications. Excellent recovery. Durable and UV Stable. Non-stretch and non-shrink. Compatible with solvent and water-based finishes.

Bubble Seal

Description	Groove Width	Colour	MOQ	Description	Groove Width	Colour	MOQ
W2 Bubble	2.6mm	Black	20 metres	W3 Bubble	3.0mm	Brown	20 metres

Flipper Seal

Description	Height	Colour	MOQ	Description	Height	Colour	MOQ
W12 Flipper	12mm	Brown	20 metres	W15 Flipper	15mm	Black	20 metres
W12 Flipper	12mm	White	20 metres	W18 Flipper	18mm	Brown	20 metres
W12 Flipper	12mm	Black	20 metres	W18 Flipper	18mm	White	20 metres
W15 Flipper	15mm	Brown	20 metres	W18 Flipper	18mm	Black	20 metres
W15 Flipper	15mm	White	20 metres				

R-Series Weather seals

Provides an effective flexible seal with groove in the rebate face. Dual hardness (TPE/Polypropylene) maximum effectiveness and ease of fitting. Available in brown or white.

Description	Height	Colour	MOQ	Description	Height	Colour	MOQ
R10 Angled Flipper	10mm	Brown	20 metres	R12 Angled Flipper	12mm	Brown	20 metres
R10 Angled Flipper	10mm	White	20 metres	R12 Angled Flipper	12mm	White	20 metres

F-SERIES – FLIPPER

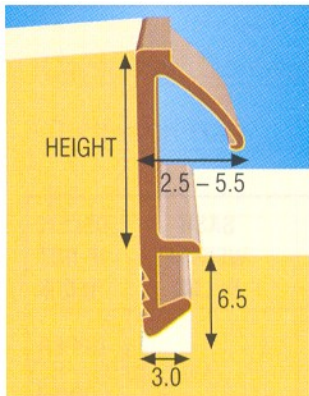

W-SERIES – BUBBLE

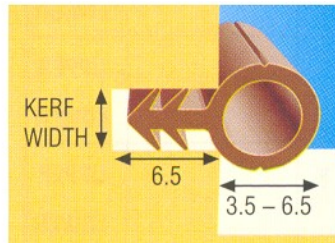

W-SERIES – FLIPPER

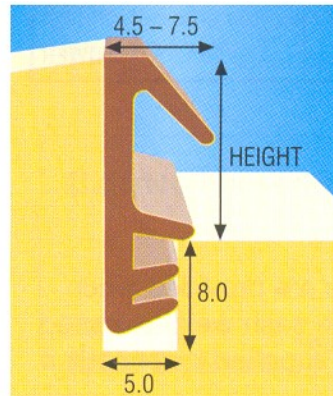

R-SERIES

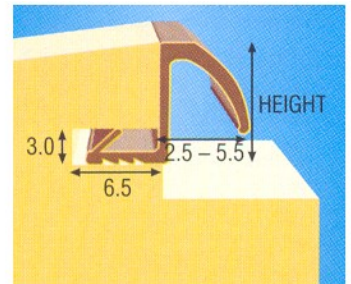

P-Series Weather seals

'P' type weather seals with a variety of useful profiles. Dual hardness (TPE/Polypropylene) for maximum effectiveness and ease of fitting. Excellent recovery. Durable and UV stable. Non-stretch and non-shrink. Compatible with solvent and water-based finishes.

<u>Description</u>		<u>Height</u>	<u>Colour</u>	<u>MOQ</u>
P7 Bubble	Rebated Bubble Seal	7mm	Brown	20 metres
P7 Bubble	Rebated Bubble Seal	7mm	White	20 metres
P8 Bubble	Offset Bubble Seal	8mm	Brown	20 metres
P8 Bubble	Offset Bubble Seal	8mm	White	20 metres
P10 Bubble	Offset Bubble Seal	10mm	Brown	20 metres
P11 Bubble	Large Offset Bubble Seal	11mm	Brown	20 metres
P11 Bubble	Large Offset Bubble Seal	11mm	White	20 metres
P12 Bubble	Flat Base Large Offset Bubble Seal	12mm	Brown	20 metres
P12 Bubble	Flat Base Large Offset Bubble Seal	12mm	White	20 metres
P16 Bubble	Tall Offset Bubble Seal	16mm	Brown	20 metres
P16 Bubble	Tall Offset Bubble Seal	16mm	White	20 metres

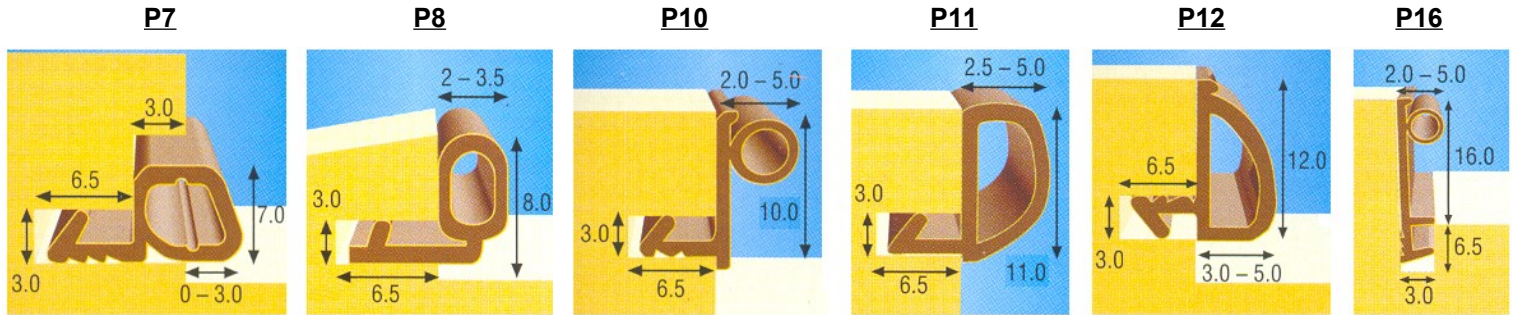

Weatherbar Plus – Bubble and Flipper

Offers improved weather performance over galvanised or plain plastic bars. Offered in bubble or flipper variants. Will not crack or shatter in sub-zero temperatures. Flexible seal is protected from damage by foot traffic treading on the bar.

<u>Description</u>	<u>Colour</u>	<u>MOQ</u>	<u>Description</u>	<u>Colour</u>	<u>MOQ</u>
W Bar Bubble – 0.92M	Brown/black	20 Metres	W Bar Flipper – 0.92M	Brown	20 Metres
W Bar Bubble – 3.0M	Brown/black	30 Metres	W Bar Flipper – 3.0M	Brown	30 Metres

DK Door Frame Wiper Seal

Seals against the elements and wipes moisture from the door. Dual hardness or maximum effectiveness and ease of fitting. Available in brown or white and two lengths.

<u>Description</u>	<u>Colour</u>	<u>MOQ</u>
DK Door Frame Wiper Seal – 2.5M	Brown	25 lengths
DK Door Frame Wiper Seal – 2.5M	White	25 lengths

Weatherbar Plus Bubble

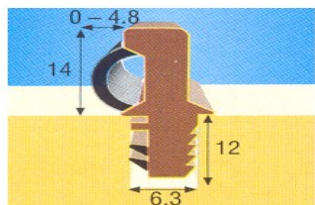

Weatherbar Plus Flipper

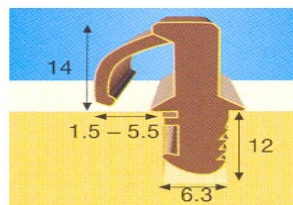

DK Door Frame Wiper Seal

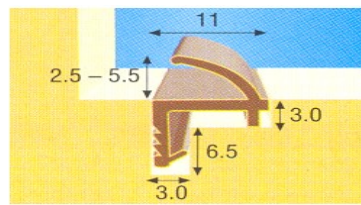

Weather stripping

Flat Carrier

Flat-based pile carrier with base. For flush fit allow 8mm wide x 3mm deep recess. Designed to incorporate any of our 4.8mm backing pile heights from 5mm to 15mm. Please specify which pile height you require when ordering. This can also be supplied with a self-adhesive base. For flush fit of the self-adhesive based carrier allow 8mm wide x 3.5mm deep recess.

<u>Description</u>	<u>Colour</u>	<u>MOQ</u>
2.2M length	White	10 lengths

<u>Description</u>	<u>Colour</u>	<u>MOQ</u>
2.2M length	Brown	10 lengths

Flat Carrier

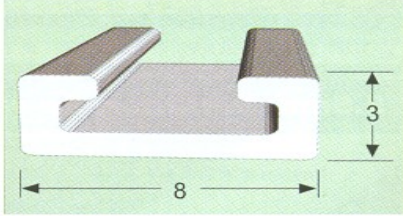

Self-adhesive Carrier

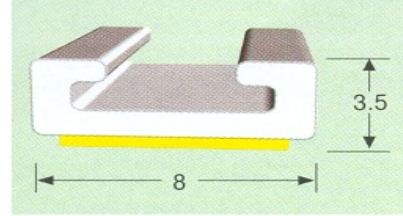

Centre Leg Carrier

Centre leg pile carrier for mechanical fitting. For flush fit allow 8mm wide x 3mm deep recess. Two types are available – for 2.5mm wide groove or 3mm wide groove – please specify which you require when ordering. Designed to incorporate any of our 4.8mm backing pile heights from 5mm to 15mm. Please specify which pile height you require when ordering.

<u>Description</u>	<u>Colour</u>	<u>Size</u>	<u>MOQ</u>
2.2M length	White	2.5mm	10 lengths
2.2M length	Brown	2.5mm	10 lengths

<u>Description</u>	<u>Colour</u>	<u>Size</u>	<u>MOQ</u>
2.2M length	White	3mm	10 lengths
2.2M length	Brown	3mm	10 lengths

Offset Leg Carrier

Offset leg pile carrier for mechanical fitting. Offset groove 2.5mm wide x 6.5mm deep. For flush fit allow 8mm wide x 3mm deep recess. Designed to incorporate any of our 4.8mm backing pile heights from 5mm to 15mm. Please specify which pile height you require when ordering.

<u>Description</u>	<u>Colour</u>	<u>MOQ</u>
2.2M length	White	10 lengths

<u>Description</u>	<u>Colour</u>	<u>MOQ</u>
2.2M length	Brown	10 lengths

Flexislide

A useful seal for either surface mounting or inset. Often used as a mid-rail seal. To prevent sideways rattle fit to both edges of sashes. Very low friction material. For surface mounting fit into groove 2mm wide x 6.5mm deep. To flush mount recess by 2mm. This product can also be supplied for fitting into a groove 3mm wide x 6.5mm deep. Please specify which size you require when ordering.

<u>Description</u>	<u>Colour</u>	<u>Size</u>	<u>MOQ</u>
2.2M length	White	2mm	10 lengths
2.2M length	Brown	2mm	10 lengths

<u>Description</u>	<u>Colour</u>	<u>Size</u>	<u>MOQ</u>
2.2M length	White	3mm	10 lengths
2.2M length	Brown	3mm	10 lengths

Centre Leg Carrier

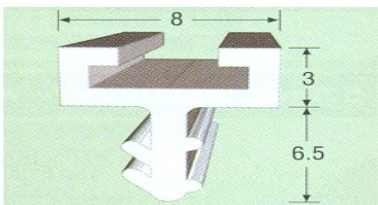

Offset Leg Carrier

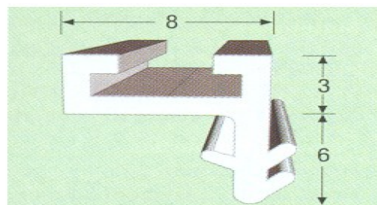

Flexislide

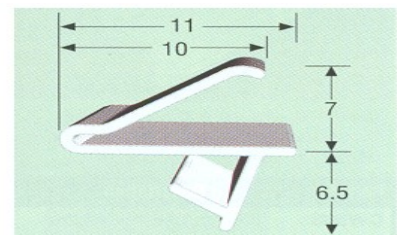

Intumescent Door Seals

Intumescent Door Seals – Fire & Smoke

Intumescent door seals for protection against fire and smoke. Self adhesive backing. To be inserted into rebate in door or frame. Supplied in tubes of 25 x 2.1 metre lengths (52.5 metres). This quantity is sufficient for sealing 10 doors. CERTIFIRE APPROVED.

Description	Size	Colour	MOQ
Fire & Smoke Door Seal	10mm x 4mm	White	10 x 2.1 metre lengths
Fire & Smoke Door Seal	10mm x 4mm	Brown	10 x 2.1 metre lengths
Fire & Smoke Door Seal	15mm x 4mm	White	10 x 2.1 metre lengths
Fire & Smoke Door Seal	15mm x 4mm	Brown	10 x 2.1 metre lengths
Fire & Smoke Door Seal	20mm x 4mm	White	10 x 2.1 metre lengths
Fire & Smoke Door Seal	20mm x 4mm	Brown	10 x 2.1 metre lengths

Intumescent Door Seals – Fire only

Intumescent door seals for protection against fire. Self adhesive backing. To be inserted into rebate in door or frame. Supplied in tubes of 25 x 2.1 metre lengths (52.5 metres). This quantity is sufficient for sealing 10 doors. CERTIFIRE APPROVED.

Description	Size	Colour	MOQ
Fire Only Door Seal	10mm x 4mm	White	10 x 2.1 metre lengths
Fire Only Door Seal	10mm x 4mm	Brown	10 x 2.1 metre lengths
Fire Only Door Seal	15mm x 4mm	White	10 x 2.1 metre lengths
Fire Only Door Seal	15mm x 4mm	Brown	10 x 2.1 metre lengths
Fire Only Door Seal	20mm x 4mm	White	10 x 2.1 metre lengths
Fire Only Door Seal	20mm x 4mm	Brown	10 x 2.1 metre lengths



Every Intumescent Door Seal has a manufacture date and a Certifire approval number printed on it.



Every Intumescent Door Seal has a manufacture date and a Certifire approval number printed on it.

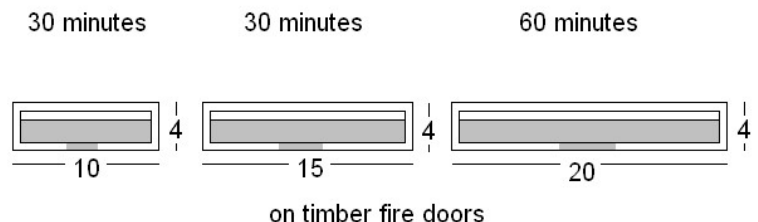
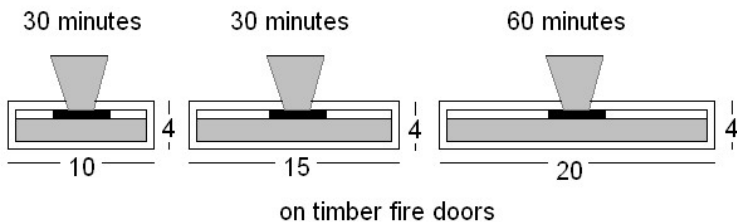

Kindagard Door Hinge Safety System

A revolutionary door hinge safety system that is quick and simple to fit. Available in white or brown and as pre-cut 1.95 metre lengths.

- * Protects fingers from being trapped in doors
- * Suitable for domestic and commercial use
- * Ideal for nurseries, schools, offices, hospitals and residential care homes
- * Fits easily in minutes
- * No special tools required
- * Pre-cut length of 1.95M suitable for most doors
- * Available in white and brown
- * If cutting is required, use heavy duty scissors or cutters

Quick and simple installation:

Gap Cover:

1. Clean the door and door frame thoroughly.
2. With the door shut, stick the channel into the corner of the door.
3. Stick the flexible cover to the door frame using the edge of the channel as a guide for positioning.
4. Open the door. Line up the foot on the flexible cover to the channel.
5. Locate and snap the foot into the channel on the door.
6. Close the door.

Hinge Cover:

1. Stick the 'L' shaped end to the door butting up to the back of the hinge.
2. Roll the cover over the hinge and stick the 'T' foot to the door frame.

<u>Description</u>	<u>Colour</u>	<u>MOQ</u>	<u>Description</u>	<u>Colour</u>	<u>MOQ</u>
Gap cover (single)	White	2-off	Gap and Hinge Cover (single)	White	2-off
Gap cover x 10 (box)	White	10-off	Gap and Hinge Cover (box)	White	10-off
Gap cover (single)	Brown	2-off	Gap and Hinge Cover (single)	Brown	2-off
Gap cover x 10 (box)	Brown	10-off	Gap and Hinge Cover (box)	Brown	10-off

Gap Cover:

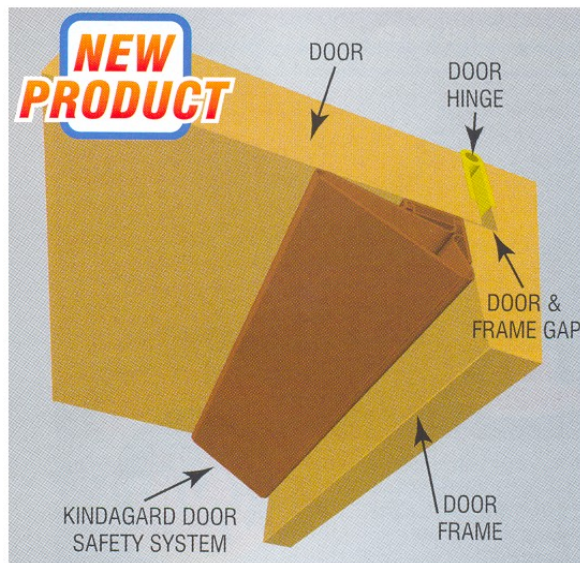
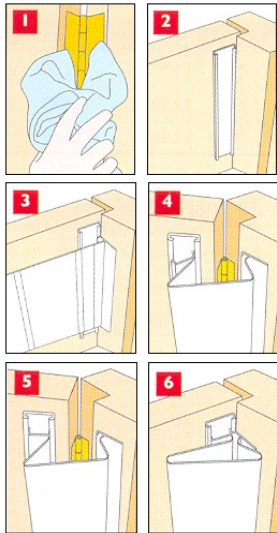

Hinge Cover:

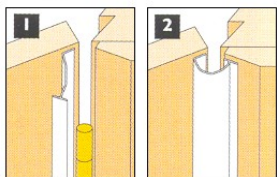

EPDM Dry Glazing Tape & SSP Seal

Dry Glazing Tape is ideal for the sealing of double glazed units into most timber windows and doors. The dry glazing tape is fitted to the edge of the rebate and the back of the glazing bead.

SSP Seal is suitable for draughtproofing existing doors and windows which do not have a groove for a mechanical fixing, also for new applications where machining a groove is not possible.

Dry Glazing Tape and SSP Seal are manufactured from EPDM cellular rubber with a skinned surface and closed cell structure to ensure that moisture will not be absorbed. With a self-adhesive surface for easy application and glass fibre mesh to ensure the tape doesn't stretch.

EPDM Glazing Tape has excellent compression recovery characteristics which mean you can be sure of an effective seal for many years.

Application:

All surfaces must be clean, dry and free from dust and grease prior to the application of the EPDM tape or seal. The application temperature should be no lower than 5°C when applying the tape.

SSP Seal – Die no. 8087 / 10633

'P' shaped gasket. Non-stretch with one self-adhesive side. A favourite for use in draught proofing existing doors.

<u>Description</u>	<u>Colour</u>	<u>MOQ</u>	<u>Description</u>	<u>Colour</u>	<u>MOQ</u>
10 x 5mm	White	30 metres	10 x 5mm	Brown	30 metres

EPDM Tape

EPDM Seal. Non-stretch with one self-adhesive side.

<u>Description</u>	<u>Colour</u>	<u>MOQ</u>	<u>Description</u>	<u>Colour</u>	<u>MOQ</u>
3mm x 9mm	Black	40 metres	4mm x 10mm	Black	40 metres
3mm x 9mm	White	40 metres	4mm x 10mm	White	40 metres
3mm x 9mm	Brown	40 metres	4mm x 10mm	Brown	40 metres
4mm x 9mm	Black	40 metres	5mm x 10mm	Black	40 metres
4mm x 9mm	White	40 metres	5mm x 10mm	White	40 metres
4mm x 9mm	Brown	40 metres	5mm x 10mm	Brown	40 metres

EPDM Tape with Lip (USED AS HALF A DRY GLAZING SYSTEM)

EPDM seal with lip. Non-stretch with one self-adhesive side.

<u>Description</u>	<u>Colour</u>	<u>MOQ</u>
3 x 12mm lipped	Black	40 metres
3 x 12mm lipped	White	40 metres
3 x 12mm lipped	Brown	40 metres

SSP Seal

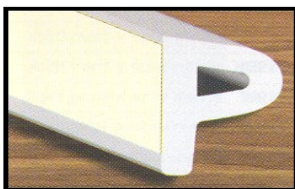

EPDM Tape

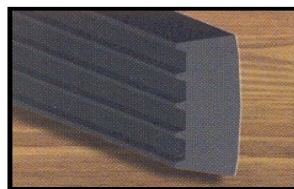

EPDM Tape with Lip

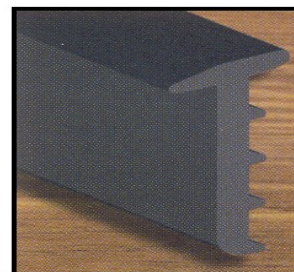

Georgian Bar Tape

Georgian Bar Tape is a high performance tape for bonding glazing bars on to the surface of glass units. This achieves a slim sight line not possible with conventional glass-in-rebate methods. The tape has a filmic release liner, which enables it to be peeled away from between glass and bar to ensure accurate positioning.

- * Good gap filling between slightly uneven materials
- * Very high shear strength, even at high temperatures
 - * Improved tack, adhesion and dynamic strength
- * Excellent resistance to water, solvents and plasticizers
- * Good adhesion to metals, glass, PVC, timber and most paints
 - * Compatible with polycarbonate and acrylic
 - * Filmic liner for easy positioning

Application:

Contact surfaces must be clean, dry, grease free and the temperature of the air and bonding items be no lower than +10°C. Use Isopropanol or similar cleaner to ensure clean contact surfaces.

Only remove filmic release liner when satisfied with position. The tape requires smooth clean surfaces and firm pressure for best results. The full bond strength may take several hours to develop.

<u>Description</u>	<u>Colour</u>	<u>MOQ</u>	<u>Description</u>	<u>Colour</u>	<u>MOQ</u>
10mm wide x 1mm thick	Black	50 metres	10mm wide x 1mm thick	White	50 metres
11mm wide x 1mm thick	Black	50 metres	11mm wide x 1mm thick	White	50 metres
12mm wide x 1mm thick	Black	50 metres	12mm wide x 1mm thick	White	50 metres
13mm wide x 1mm thick	Black	50 metres	13mm wide x 1mm thick	White	50 metres
14mm wide x 1mm thick	Black	50 metres	14mm wide x 1mm thick	White	50 metres
15mm wide x 1mm thick	Black	50 metres	15mm wide x 1mm thick	White	50 metres
16mm wide x 1mm thick	Black	50 metres	16mm wide x 1mm thick	White	50 metres
17mm wide x 1mm thick	Black	50 metres	17mm wide x 1mm thick	White	50 metres
18mm wide x 1mm thick	Black	50 metres	18mm wide x 1mm thick	White	50 metres
19mm wide x 1mm thick	Black	50 metres	19mm wide x 1mm thick	White	50 metres
20mm wide x 1mm thick	Black	50 metres	20mm wide x 1mm thick	White	50 metres
21mm wide x 1mm thick	Black	50 metres	21mm wide x 1mm thick	White	50 metres
22mm wide x 1mm thick	Black	50 metres	22mm wide x 1mm thick	White	50 metres
23mm wide x 1mm thick	Black	50 metres	23mm wide x 1mm thick	White	50 metres
24mm wide x 1mm thick	Black	50 metres	24mm wide x 1mm thick	White	50 metres
25mm wide x 1mm thick	Black	50 metres	25mm wide x 1mm thick	White	50 metres
26mm wide x 1mm thick	Black	50 metres	26mm wide x 1mm thick	White	50 metres

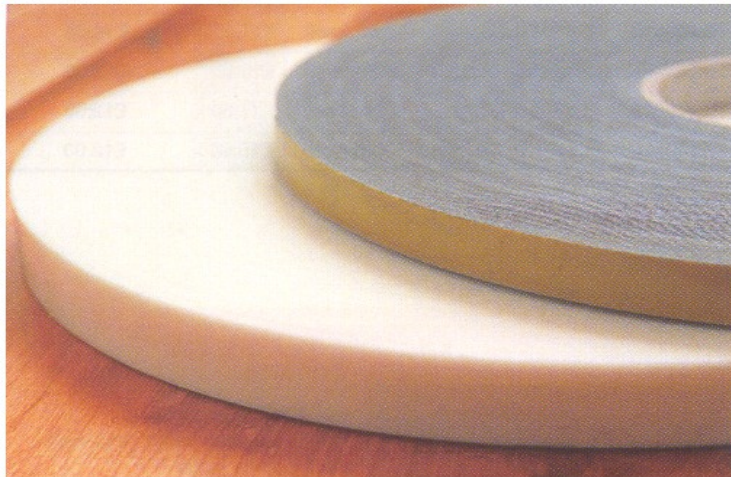

Security Glazing Tape

The perceived threat of burglary through windows is of major concern to homeowners. This can be addressed by the use of Security Glazing Tape placed between the glass and the rebate.

Security Glazing Tape is manufactured from PVC foam coated with a high performance solvent-based pure acrylic adhesive. The tape is available in a range of widths and thicknesses to suit the application. It is guaranteed for a period of fifteen years from the date of order, providing that the product has been used under normal environmental conditions in the manner specified and that it has been correctly selected and applied.

* Designed to prevent unauthorised removal of the glass unit from externally glazed windows

* Cost-effective and easy to install

* Moisture resistant solvent based adhesive

* No special tools required and no trimming necessary

Application:

Ideally the tape should be used in a drained and vented application. If not practical a bedded application is possible using a good quality neutral cure silicone to fill the void around the tape and glass unit. Ensure the tape is compressed by 3% when fixing the beads as this will obtain a watertight installation.

The tape should be applied level with the top edge of the rebate to eliminate a water/dirt trap. Tape on horizontal rebates should run past the verticals. Tape on the vertical surfaces should be butted snugly up to the horizontals.

As with all self-adhesive products, application procedures are important to the ongoing performance of the Security Glazing Tape. The bonding surfaces must be clean, dry and grease free.

If in doubt use an industrial cleaner such as Isopropanol to ensure clean surfaces. The tape should only be applied when the temperature is above 10°C (air, timber and glass).

<u>Description</u>	<u>Colour</u>	<u>MOQ</u>
10mm wide x 1mm thick	Black	50 metres
10mm wide x 2mm thick	Black	50 metres
10mm wide x 3mm thick	Black	50 metres
10mm wide x 4mm thick	Black	50 metres
12mm wide x 1mm thick	Black	50 metres
12mm wide x 2mm thick	Black	50 metres
12mm wide x 3mm thick	Black	50 metres
12mm wide x 4mm thick	Black	50 metres
15mm wide x 1mm thick	Black	50 metres
15mm wide x 2mm thick	Black	50 metres
15mm wide x 3mm thick	Black	50 metres
15mm wide x 4mm thick	Black	50 metres

THIS IS A SELECTION OF SOME OF OUR PARTS IN TPR, EPDM AND SILICONE , TRADE ENQUIRES FROM EXISTING DIES OR NEW PROPOSALS WELCOME

SEE: www.rubber-extrusions-seals.co.uk

GEORGE CULLEY

Unit 8 Dodgson Industrial Estate
Dodgson Street
Rochdale
Lancashire , OL16 5SJ

TEL: 0161 622 0020 FAX : 0161 622 0010

over 1500 profiles

PLEASE DO NOT SCALE, THIS IS A QUICK SKETCH OR AN ENHANCED COPY TO SHOW DETAIL THE STATED MEASUREMENTS ARE CORRECT

5.50
DIA



6.50

ADHESIVE BACKED
BROWN OR WHITE
5.50 DIA 6.5 MM FOOT
TPE

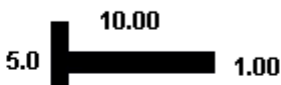

1.0

CURRENTLY BLACK
RESL SILICONE DIE 1353
TRANSLUCENT COULD
BE MADE TO ORDER

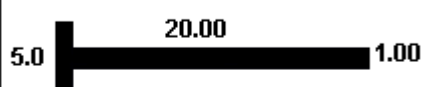

1.0

CURRENTLY BLACK
RESL SILICONE DIE 1354
TRANSLUCENT COULD
BE MADE TO ORDER

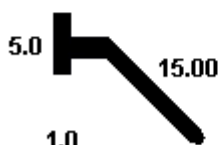

1.0

ANGLED EPDM BLADE
EPDM BLACK ONLY

15 MM

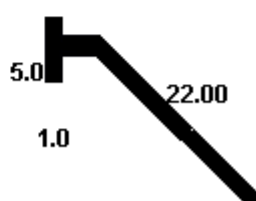

1.0

ANGLED EPDM BLADE
EPDM BLACK ONLY

22.00 MM



FIN OR NO FIN

3.00 MM TO
15.00 MM

stock of 4 , 6 , 10 mm
grey plain pile

RESL SELF ADHESIVE PILE SEALS
MADE TO ORDER
WHITE , BLACK , GREY , BROWN
MANY PLAIN SECTIONS EX STOCK

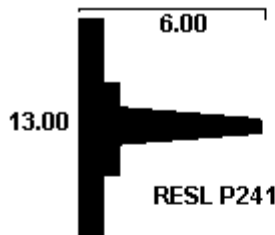

RESL P241

EPDM BLACK ONLY

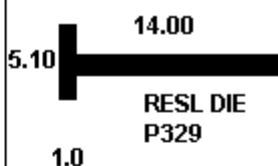

RESL DIE
P329

RESL DIE NO 11727

EPDM BLACK ONLY

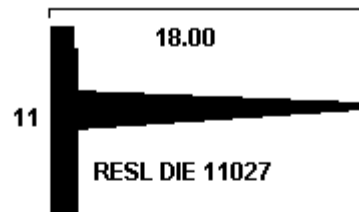

RESL DIE 11027

EPDM BLACK ONLY



8.50

5

RESL THERMOBUBBLE
WHITE
BLACK
TRANSLUCENT
OTHER COLOURS TO ORDER
(MANY OF OUR CARRIERS FIT)
SILICONE
FROM -50 DEGREES
TO 200 DEGREES C

apply
RTV108



RESL DIE NO 9710

RESL UNIVERSAL GLASS DOOR SEAL
TRANSLUCENT SILICONE BOND WITH
RTV SILICONE



RESL INDUSTRIAL PREMIER BRUSH STRIP RANGE
A FULL RANGE FROM 5 MM TO 300 MM

RESL
SELF
ADHESIVE
FOAM STRIPS



SILICONE, NEOPRENE, EPDM, SOFT PVC