

CUSTOM COLLECTION

2024



DellaLo^o
MILANO



DellaLo' Milano è una sartoria artigianale concepita per dare ai danzatori e a tutti gli artisti del mondo dello spettacolo la possibilità di acquistare capi personalizzati e realizzati con materie prime esclusivamente di origine italiana. Realizziamo capi unici confezionati singolarmente da esperte sarte italiane che lavorano con maestria curando ogni dettaglio.

I capi sono lavorati totalmente a mano, dal taglio alla confezione per terminare con la cucitura della Margherita, simbolo che contraddistingue il nostro marchio. Una volta pronti i capi sono sottoposti ad un lavaggio accurato per dare ai nostri clienti la possibilità di indossarli subito freschi e profumati. La nostra missione è garantire una vestibilità perfetta rendendo unico e speciale ogni capo.

DellaLo' Milano is a tailoring company designed to offer ballet dancers and entertainers the opportunity to purchase custom made apparel made of materials exclusively of Italian origin.

We create unique garments made by the expert hands of Italian tailors, who work with skill and attention to the detail.

The items are processed individually and finished by hand, complete with a daisy logo, symbol that distinguishes our brand.

Once ready the garments are subjected to the thorough wash so our customers can wear them fresh and scented.

Our mission is to ensure a perfect fit making special every garment.

CUSTOM COLLECTION

Our Customization service gives you the option to change **the colors and fabrics** combinations of the **Collection's leotards**.

Please note: The collection garments can be customized just by changing fabrics and colors. It is not possible to change their design.

Customization with **DellaLo' Belt** is possible only for the Collection models that have already it.

N.B. The **Shipping time** for Custom Made garments is **60-90 days** from the order confirmation and payment.



BRIGID CL CD15038

-  1st Fabric (Bottom, Top)- Warp knit fabric
-  2nd Fabric (Top overlap)
-  3rd Fabric (Insert, straps)

Fabric (2)	Code	Price
Tulle	TP	160€
Lace	P	175€
Viscose Lace	PV	182€
Embroidered Tulle	TR	189€
DellaLo' Lace	PD	196€
DellaLo' Embroidered tulle	TRD	210€

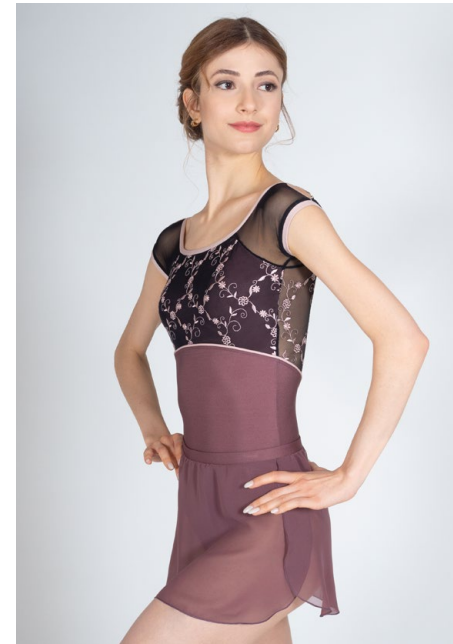
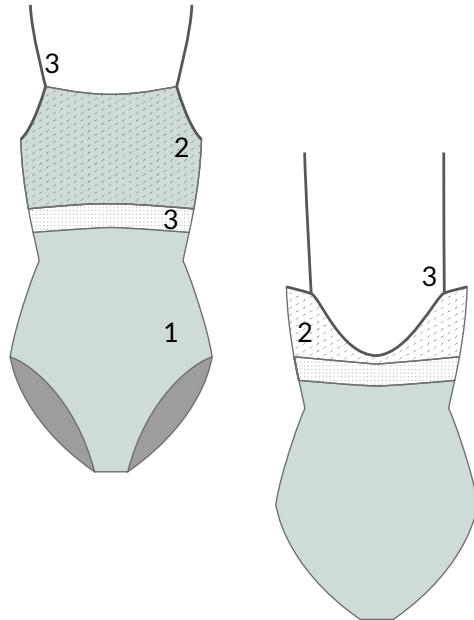

ARTEMIDE CL CD15057

-  1st Fabric (Bottom - Top) - Warp knit fabric
-  2nd Fabric (Top overlap)
-  3rd Fabric (Sleeves) - Tulle
-  4th Fabric (Trimming, Piping) - Warp knit fabric

Fabric (2)	Code	Price
Tulle	TP	175€
Lace	P	190€
Viscose Lace	PV	198€
Embroidered Tulle	TR	206€
DellaLo' Lace	PD	214€
DellaLo' Embroidered tulle	TRD	230€





AFRODITE CL CD15061

-  1st Fabric (Bottom)- Warp knit fabric
-  2nd Fabric (Top)- Warp knit fabric
-  3rd Fabric (Top overlap, cuffs)
-  4th Fabric (Sleeves) - Tulle

Fabric (3)	Code	Price
Tulle	TP	160€
Lace	P	175€
Viscose Lace	PV	182€
Embroidered Tulle	TR	189€
DellaLo' Lace	PD	145€
DellaLo' Embroidered tulle	TRD	232€

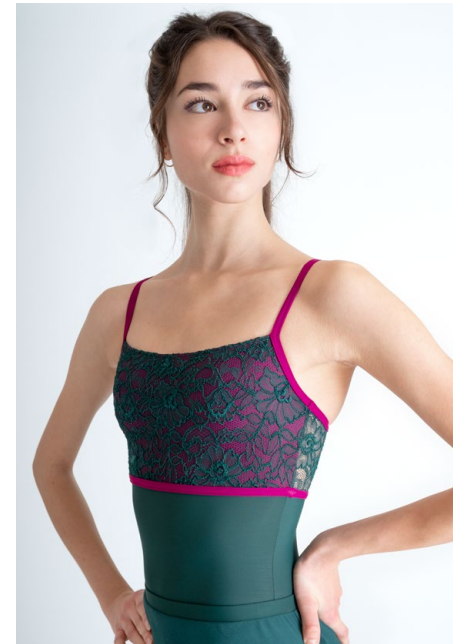

GAIA CL CD15070

-  1st Fabric (Bottom)- Warp knit fabric
-  2nd Fabric (Top, Straps)- Warp knit fabric
-  3rd Fabric (Top overlap)

Fabric (3)	Code	Price
Tulle	TP	160€
Lace	P	175€
Viscose Lace	PV	182€
Embroidered Tulle	TR	189€
DellaLo' Lace	PD	145€
DellaLo' Embroidered tulle	TRD	232€

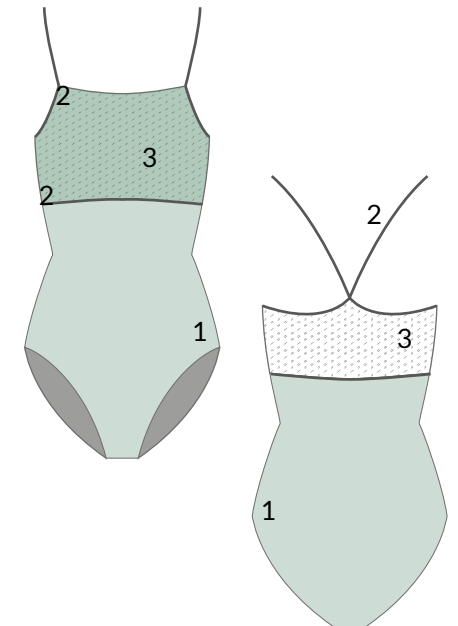





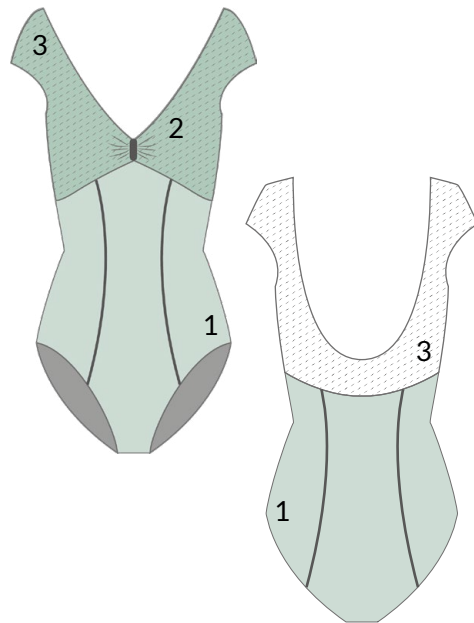

VENERE CL CD15079

-  1st Fabric (Bottom) - Warp knit fabric
-  2nd Fabric (Top) - Warp knit fabric
-  3^d Fabric (Top overlap)

Fabric (3)	Code	Price
Tulle	TP	175€
Lace	P	190€
Viscose Lace	PV	198€
Embroidered Tulle	TR	206€
DellaLo' Lace	PD	159€
DellaLo' Embroidered tulle	TRD	254€



ISIDE CL CD15088

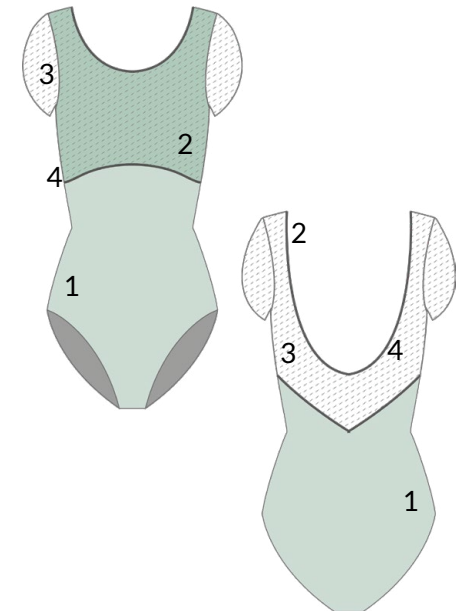

-  1st Fabric (Bottom, Trimming: neckline) - Warp knit fabric
-  2nd Fabric (Top) - Warp knit fabric
-  3^d Fabric (Top overlap, sleeves)
-  4th Fabric (Neckline piping, under breast trimming) - Warp knit fabric

Fabric (3)	Code	Price
Tulle	TP	203€
Embroidered Tulle	TR	240€
DellaLo' Embroidered tulle	TRD	268€







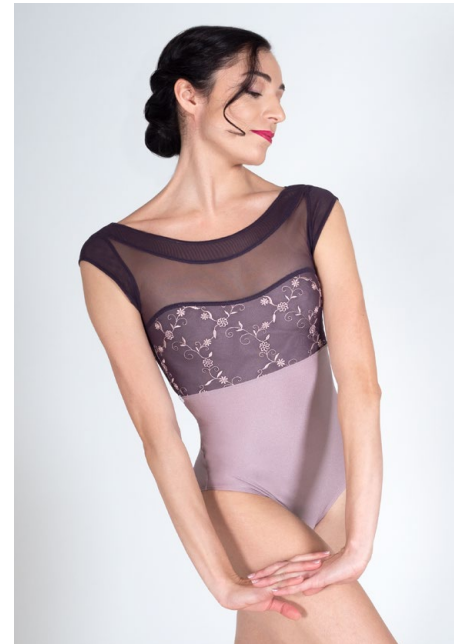
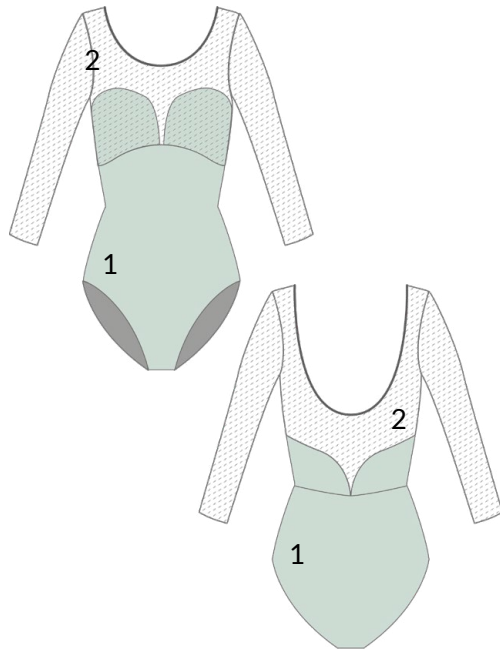

TERSICORE CL CD15089

-  1st Fabric (Bottom, heart, trimming) - Warp knit fabric
-  2nd Fabric (Top overlap, sleeves)

Fabric (2)	Code	Price
Tulle	TP	218€
Embroidered Tulle	TR	258€
DellaLo' Embroidered tulle	TRD	287€



DIANA CL CD15090



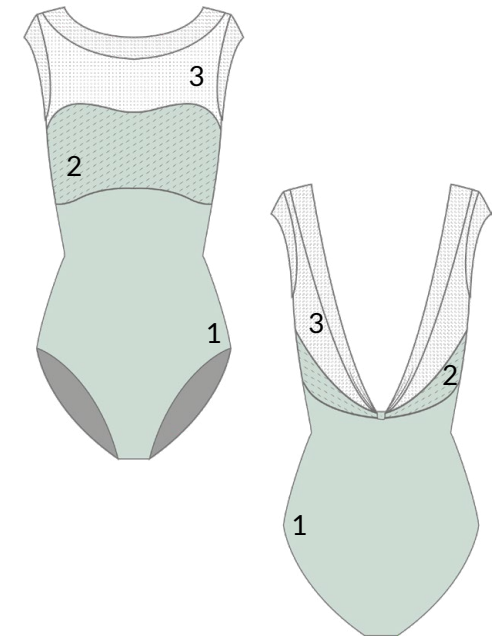

-  1st Fabric (Bottom, heart) - Warp knit fabric
-  2nd Fabric (Top overlap)
-  3RD Fabric (Top, sleeve) - Tulle

Fabric (2)	Code	Price
Tulle	TP	218€
Embroidered Tulle	TR	258€
DellaLo' Embroidered tulle	TRD	287€





MINERVA CL CD15091

-  1st Fabric (Bottom, neckline trimming)- Warp knit fabric
-  2nd Fabric (Top)- Warp knit fabric
-  3rd Fabric (Top overlap, sleeves)
-  4th Fabric (Under breast trimming) - Warp knit fabric

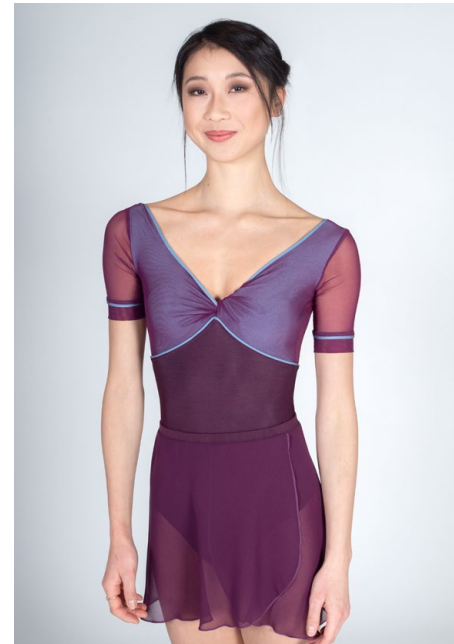

EMERA CL CD15092

-  1st Fabric (Bottom)- Warp knit fabric
-  2nd Fabric (Top, Trimming)- Warp knit fabric
-  3rd Fabric (Top overlap, sleeves)

Fabric (3)	Code	Price
Tulle	TP	143€
Lace	P	172€
Viscose Lace	PV	179€
Embroidered Tulle	TR	186€
DellaLo' Lace	PD	193€
DellaLo' Embroidered tulle	TRD	229€

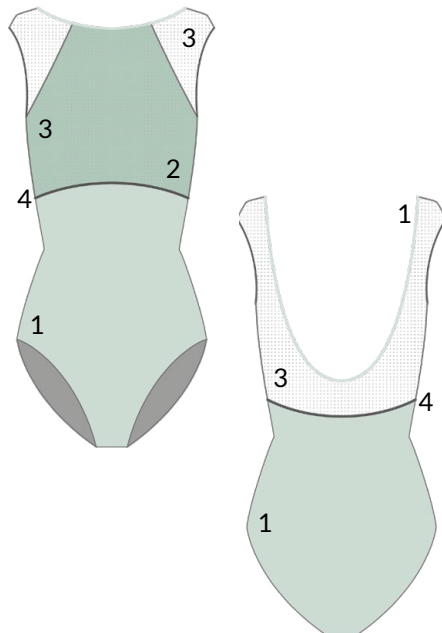

Fabric (3)	Code	Price
Tulle	TP	158€

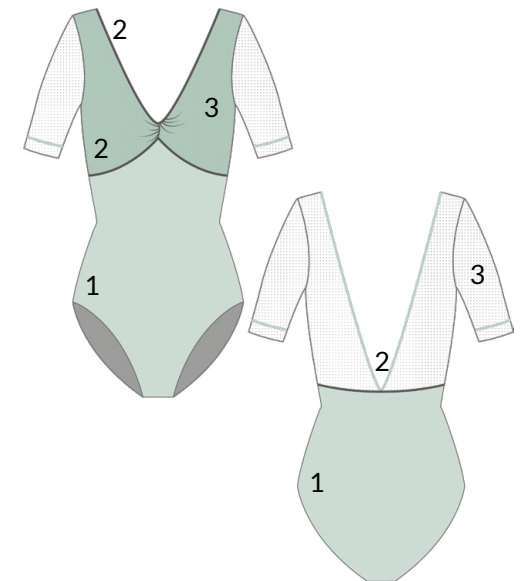



ECATE CL CD15093

-  1st Fabric (Bottom)- Warp knit fabric
-  2nd Fabric (Top)- Warp knit fabric
-  3rd Fabric (Top overlap)



LUNA CL CD15094

-  1st Fabric (Bottom, top)- Warp knit fabric
-  2nd Fabric (Top overlap)
-  3rd Fabric (Top, sleeves) - Tulle
-  4th Fabric (Neckline, under breast trimming) - Warp knit fabric

Fabric (3)	Code	Price
Tulle	TP	203€
Embroidered Tulle	TR	240€
DellaLo' Embroidered tulle	TRD	268€

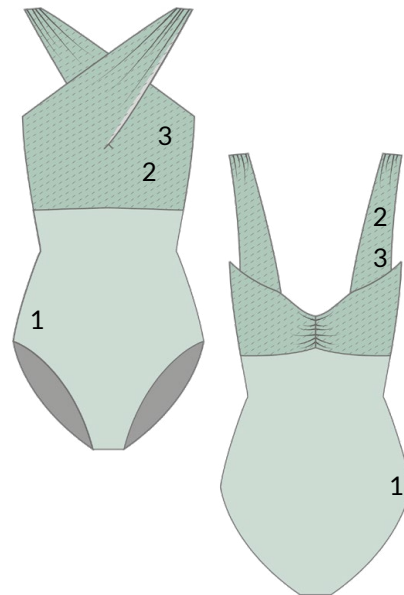

Fabric (2)	Code	Price
Tulle	TP	218€
Embroidered Tulle	TR	258€
DellaLo' Embroidered tulle	TRD	287€

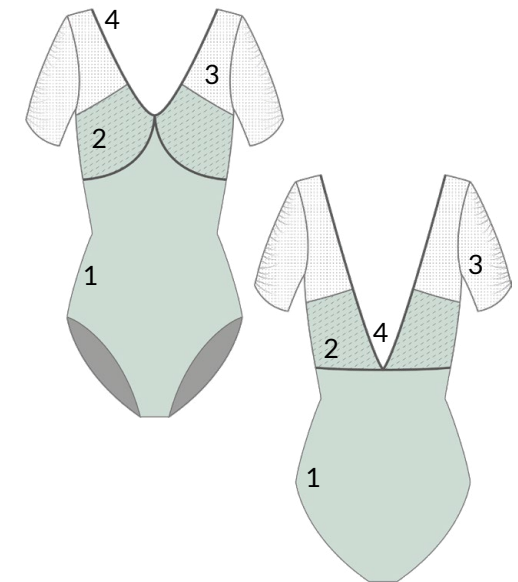

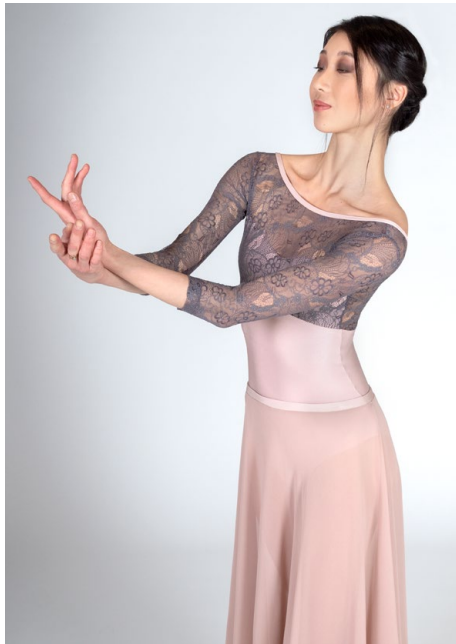

DIANA DI CD15007

- 1st Fabric (Bottom, heart insert, trimming)- Warp knit fabric
- 2nd Fabric (Top overlap, sleeves)



FLORA DI CD15010

- 1st Fabric (Bottom, top)- Warp knit fabric
- 2nd Fabric (Top overlap, sleeves)

Fabric (2)	Code	Price
Tulle	TP	175€
Lace	P	190€
Viscose Lace	PV	198€
Embroidered Tulle	TR	206€
DellaLo' Lace	PD	159€
DellaLo' Embroidered tulle	TRD	254€

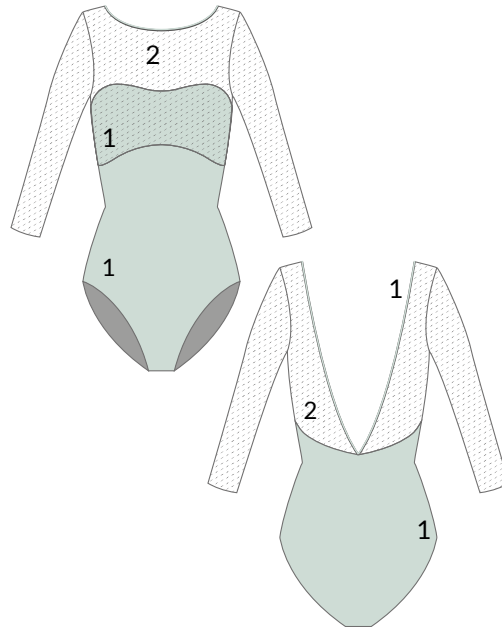

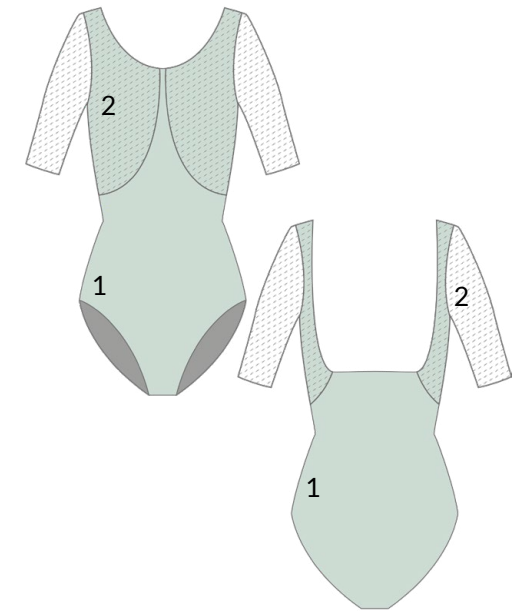

Fabric (2)	Code	Price
DellaLo' Lace	PD	139€





TERSICORE DI CD15025

-  1st Fabric (Bottom, heart insert)-
Warp knit fabric
-  2nd Fabric (Top overlap, sleeves)



SELENE DI CD15034

-  1st Fabric (Bottom, heart insert)-
Warp knit fabric
-  2nd Fabric (Top overlap)

Fabric (2)	Code	Price
Tulle	TP	152€
Lace	P	166€
Viscose Lace	PV	173€
Embroidered Tulle	TR	180€
DellaLo' Lace	PD	139€
DellaLo' Embroidered tulle	TRD	222€

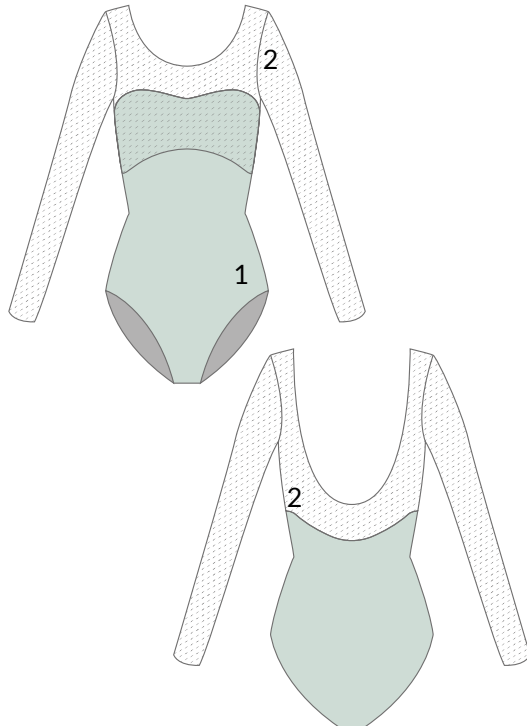

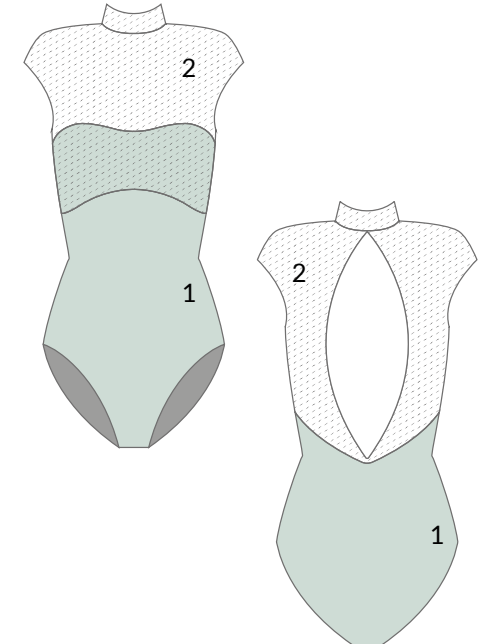

Fabric (2)	Code	Price
Tulle	TP	232€
Lace	P	253€
Embroidered Tulle	TR	275€
DellaLo' Lace	PD	285€
DellaLo' Embroidered tulle	TRD	306€







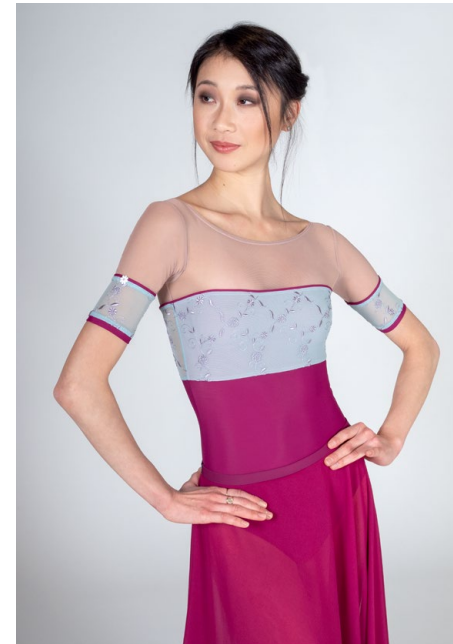
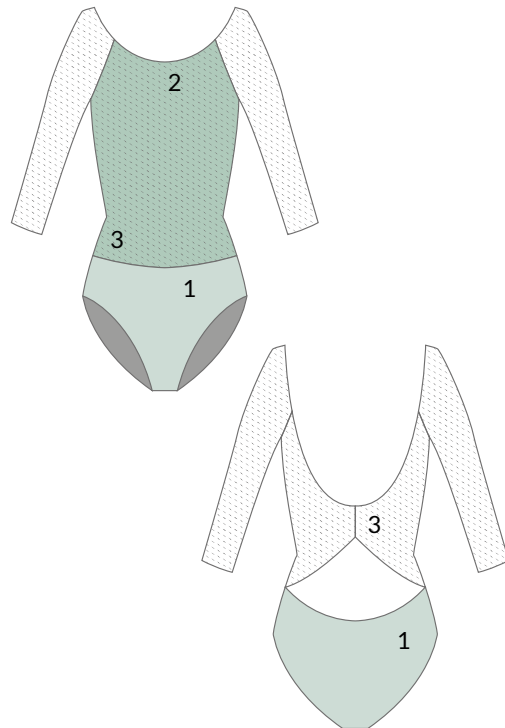

TACITA DI CD15042

-  1st Fabric (Bottom)- Warp knit fabric
-  2nd Fabric (Top)- Warp knit fabric
-  3rd Fabric (Top overlap, sleeves)

Fabric (3)	Code	Price
Tulle	TP	232€
Embroidered Tulle	TR	275€
DellaLo' Embroidered tulle	TRD	306€



MINERVA DI CD15052



-  1st Fabric (Bottom, piping)- Warp knit fabric
-  2nd Fabric (Top)- Warp knit fabric
-  3rd Fabric (Top overlap, cuff)
-  4th Fabric (Top) - Tulle

Fabric (3)	Code	Price
Tulle	TP	261€
Embroidered Tulle	TR	309€
DellaLo' Embroidered tulle	TRD	344€







SVETLANA DI CD15063

-  1st Fabric (Bottom, heart insert, trimming)- Warp knit fabric
-  2nd Fabric (Top overlap, sleeves)



ERA DI CD15068

-  1st Fabric (Bottom, neckline trimming)- Warp knit fabric
-  2nd Fabric (Top)- Warp knit fabric
-  3rd Fabric (Top overlap)
-  4th Fabric (Insert) - DellaLo' daisy ornaments

Fabric (2)	Code	Price
Tulle	TP	203€
Lace	P	222€
Viscose Lace	PV	231€
Embroidered Tulle	TR	240€
DellaLo' Lace	PD	249€
DellaLo' Embroidered tulle	TRD	268€

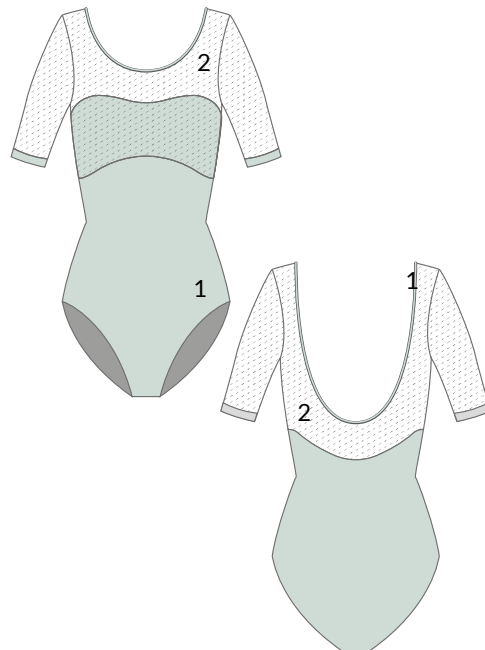

Fabric (3)	Code	Price
Tulle	TP	305€
Embroidered Tulle	TR	360€
DellaLo' Embroidered tulle	TRD	400€

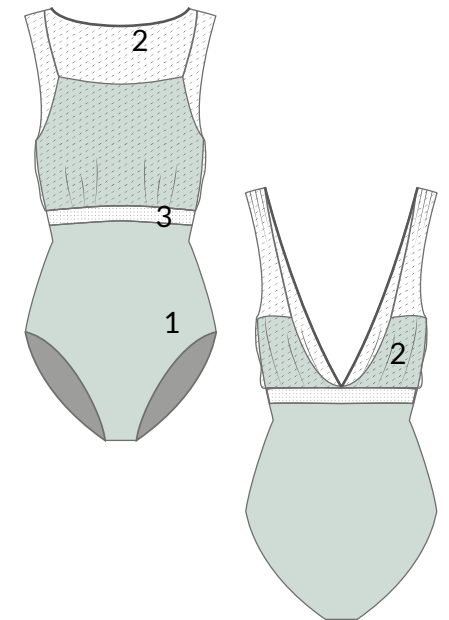





CALLIOPE AR CD15004

-  1st Fabric (Bottom, collar)-Warp knit fabric
-  2nd Fabric (Top)- Warp knit fabric
-  3rd Fabric (Top overlap)

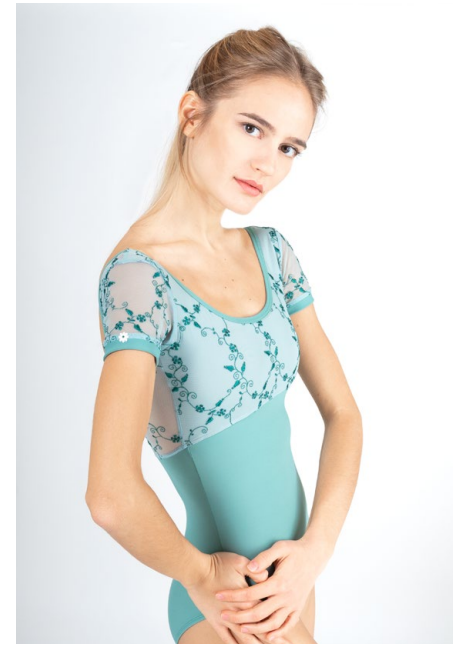
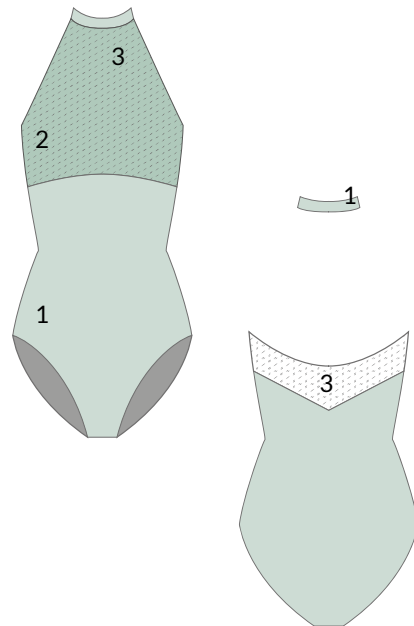
Fabric (2)	Code	Price
Tulle	TP	158€
Lace	P	171€
Viscose Lace	PV	178€
Embroidered Tulle	TR	185€
DellaLo' Lace	PD	192€
DellaLo' Embroidered tulle	TRD	207€



ISIDE AR CD15014

-  1st Fabric (Bottom, top, Trimming)-Warp knit fabric
-  2nd Fabric (Top overlap)

Fabric (2)	Code	Price
Tulle	TP	160€
Lace	P	175€
Viscose Lace	PV	182€
Embroidered Tulle	TR	289€
DellaLo' Lace	PD	196€
DellaLo' Embroidered tulle	TRD	211€







MINERVA AR CD15020

-  1st Fabric (Bottom, cuff)- Warp knit fabric
-  2nd Fabric (Top)

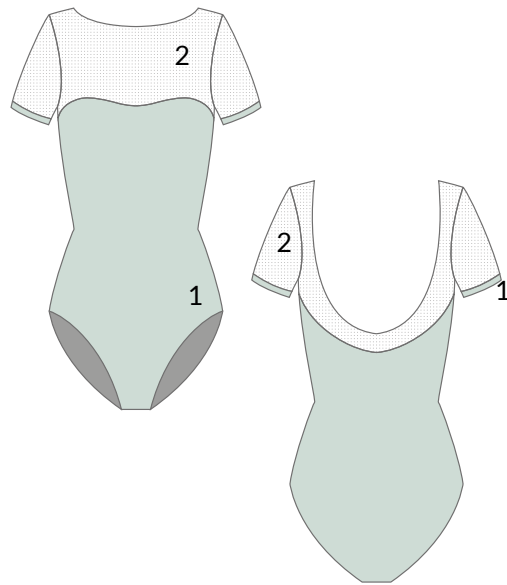
Fabric (2)	Code	Price
Tulle	TP	125€
Lace	P	150€
Viscose Lace	PV	157€
Embroidered Tulle	TR	163€
DellaLo' Lace	PD	169€
DellaLo' Embroidered tulle	TRD	182€



PENELOPE AR CD15031

-  1st Fabric (Bottom, top, Trimming)- Warp knit fabric
-  2nd Fabric (Top overlap)

Fabric (2)	Code	Price
Tulle	TP	206€
Lace	P	225€
Viscose Lace	PV	234€
Embroidered Tulle	TR	245€
DellaLo' Lace	PD	253€
DellaLo' Embroidered tulle	TRD	272€





AFRODITE AR CD15032

-  1st Fabric (Bottom, top)- Warp knit fabric
-  2nd Fabric (Sleeves, Insert)
-  3rd Fabric (Neckline trimming, cuff, piping) - Warp knit fabric



VESTA AR CD15044

-  1st Fabric (Bottom, top)- Warp knit fabric
-  2nd Fabric (Top overlap, sleeves)
-  3rd Fabric (Insert) - Tulle

Fabric (2)	Code	Price
Tulle	TP	218€
Lace	P	238€
Viscose Lace	PV	248€
Embroidered Tulle	TR	257€
DellaLo' Lace	PD	267€
DellaLo' Embroidered tulle	TRD	287€

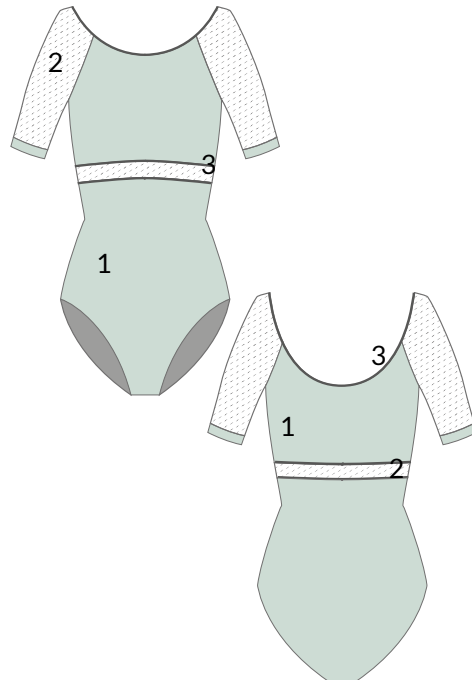

Fabric (2)	Code	Price
Tulle	TP	254€
Embroidered Tulle	TR	300€
DellaLo' Embroidered tulle	TRD	335€

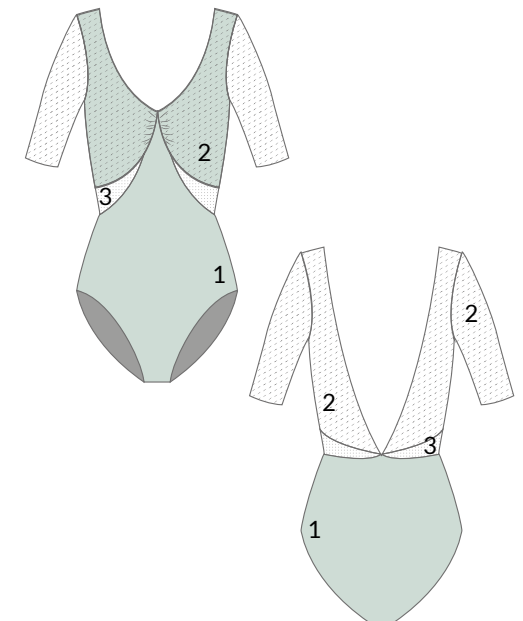



IRIS AR CD15051

-  1st Fabric (Bottom)- Warp knit fabric
-  2nd Fabric (Top)- Warp knit fabric
-  3rd Fabric (Top overlap)
-  4th Fabric (Insert4- DellaLo' Belt)

Fabric (2)	Code	Price
Tulle	TP	254€
Lace	P	277€
Viscose Lace	PV	289€
Embroidered Tulle	TR	300€
DellaLo' Lace	PD	312€
DellaLo' Embroidered tulle	TRD	335€

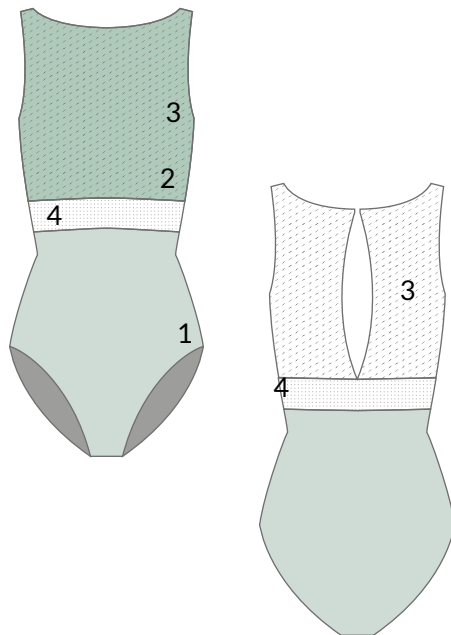

ARTEMIDE AR CD15053

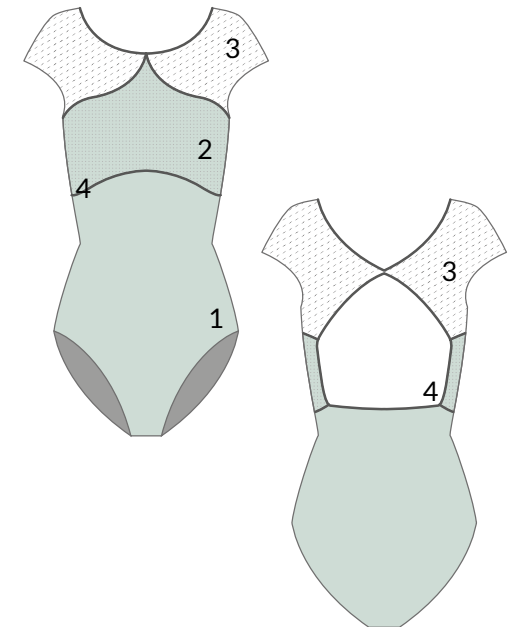

-  1st Fabric (Bottom, Top)- Warp knit fabric
-  2nd Fabric (Top overlap)
-  3rd Fabric (Sleeves)
-  4th Fabric (Piping, trimming) - Warp knit fabric

Fabric (3)	Code	Price
Tulle	TP	276€
Embroidered Tulle	TR	326€
DellaLo' Embroidered tulle	TRD	364€







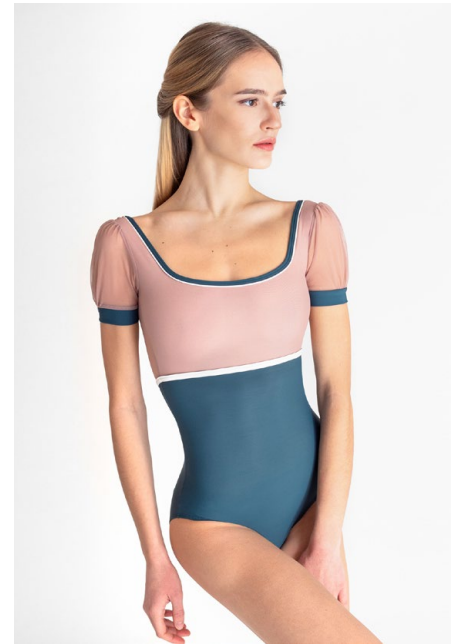
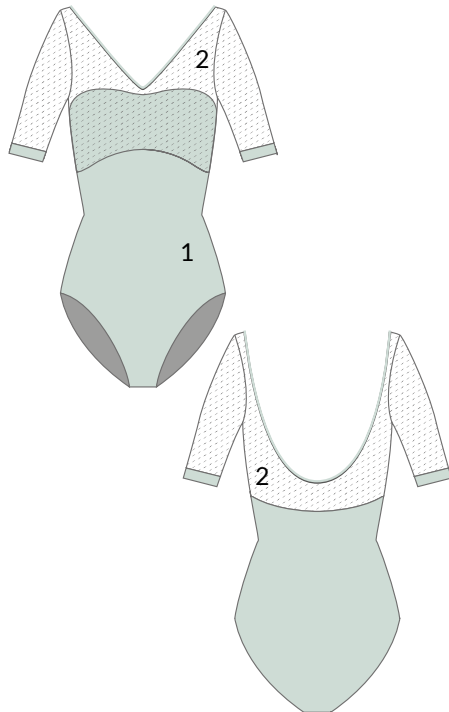

MAIA AR CD15055

-  1st Fabric (Bottom, heart insert, Trimming)- Warp knit fabric
-  2nd Fabric (Top overlap)

Fabric (2)	Code	Price
Tulle	TP	160€
Lace	P	174€
Viscose Lace	PV	182€
Embroidered Tulle	TR	189€
DellaLo' Lace	PD	196€
DellaLo' Embroidered tulle	TRD	210€



PENELOPE AR CD15062

-  1st Fabric (Bottom, neckline trimming, cuff)-Warp knit fabric
-  2nd Fabric (Top)- Warp knit fabric
-  3rd Fabric (Top overlap, sleeves)
-  4th Fabric (Neckline piping, under breast trimming) - Warp knit fabric

Fabric (3)	Code	Price
Tulle	TP	182€
Embroidered Tulle	TR	215€
DellaLo' Embroidered tulle	TRD	239€

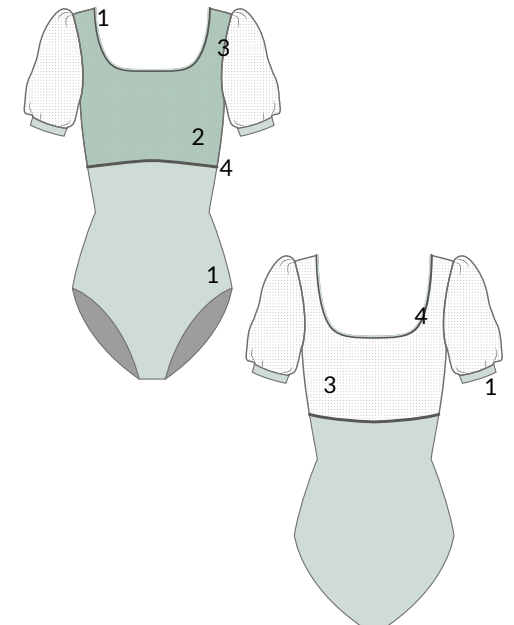





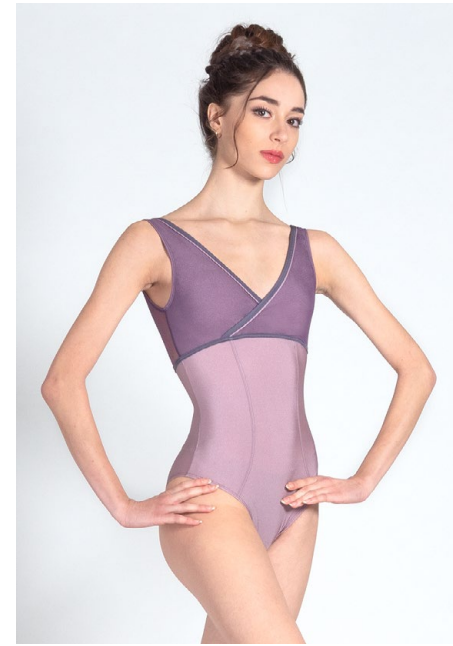
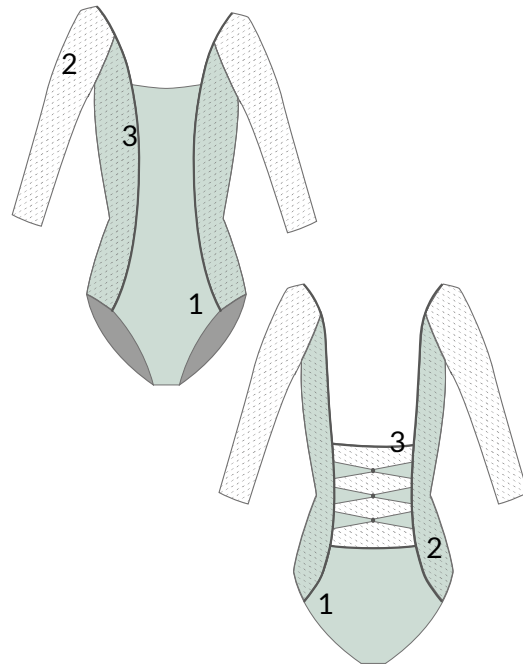

IRENE AR CD15071

-  1st Fabric (Bottom, Ribbons)- Warp knit fabric
-  2nd Fabric (Top overlap, sleeves)
-  3rd Fabric (Piping)- Warp knit fabric

Fabric (2)	Code	Price
Tulle	TP	203€
Embroidered Tulle	TR	240€
DellaLo' Embroidered tulle	TRD	268€



MEDEA AR CD15080

-  1st Fabric (Bottom, Top, piping)- Warp knit fabric
-  2nd Fabric (Top overlap)
-  3rd Fabric (Under-breast & neckline trimming)- Warp knit fabric

Fabric (2)	Code	Price
Tulle	TP	196€
Lace	P	214€
Embroidered Tulle	TR	232€
DellaLo' Embroidered tulle	TRD	259€

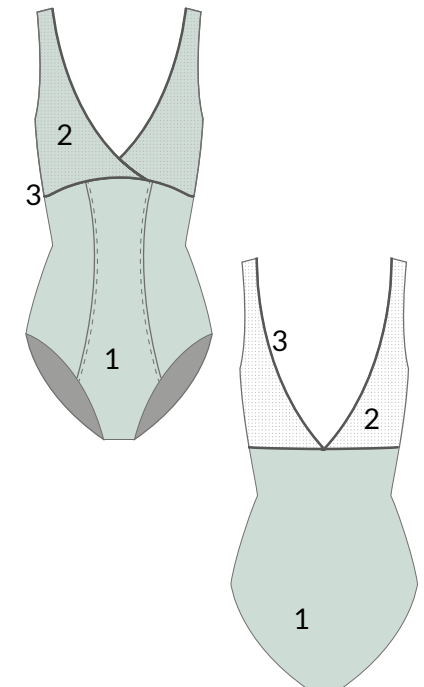



IRIS AR CD15081

-  1st Fabric (Bottom, top)- Warp knit fabric
-  2nd Fabric (Top overlap)
-  3rd Fabric (Belt)-Tulle
-  4th Fabric (Piping)- Warp knit fabric

Fabric (3)	Code	Price
Tulle	TP	196€
Lace	P	214€
Embroidered Tulle	TR	232€
DellaLo' Lace	PD	259€
DellaLo' Embroidered tulle	TRD	285,12€

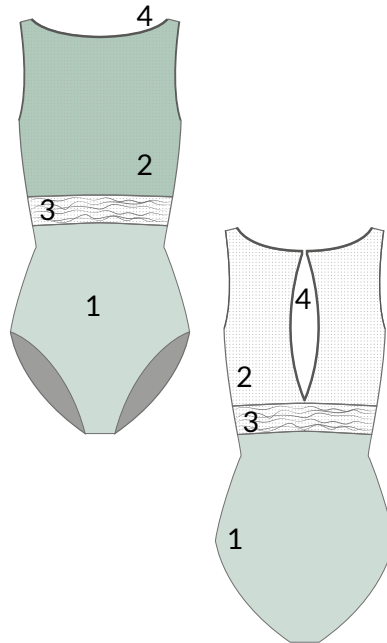



TOP SIBILLA CA15012

-  1st Fabric (Top)
-  2nd Fabric (DellaLo' daisy ornament)
-  3rd Fabric (Trimming)-Warp knit fabric

Fabric	Code	Price
Warp knit fabric	L	105€
Tulle	TP	115€

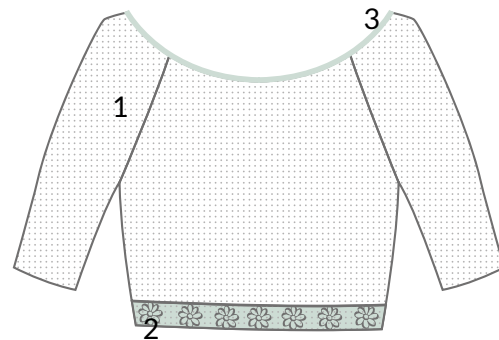

TOP SIBILLA CA15013

-  1st Fabric (Top, sleeves)

Fabric (1)	Code	Price
Tulle	TP	50€
Lace	P	63€
Viscose Lace	PV	66€
Embroidered Tulle	TR	69€
DellaLo' Lace	PD	71€
DellaLo' Embroidered tulle	TRD	77€

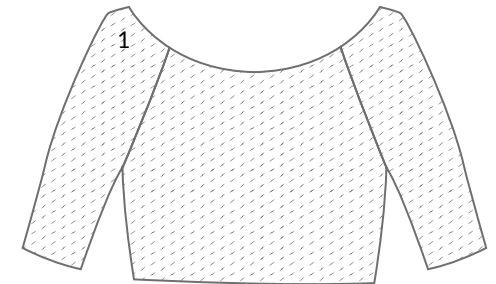



DELLALO' SKIRT CA15007

- 1st Fabric (Belt)-Warp knit fabric
- 2nd Fabric (Skirt)



SOGNO SKIRT CA15009

- 1st Fabric (Belt)-Warp knit fabric
- 2nd Fabric (Skirt)

Fabric (2)	Code	Price
Georgette	G	55€
Tulle	TP	78€
Lace	P	92€
DellaLo' Lace	PD	99€
DellaLo' Embroidered tulle	TRD	120€

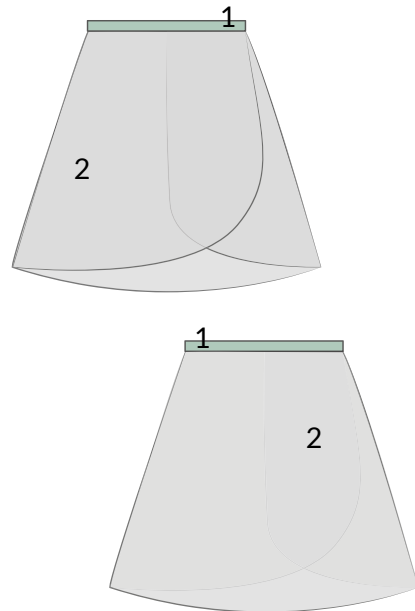

Fabric (2)	Code	Price
Georgette	G	90€
Tulle	TP	127€
Lace	P	150€
DellaLo' Lace	PD	162€
DellaLo' Embroidered tulle	TRD	196€

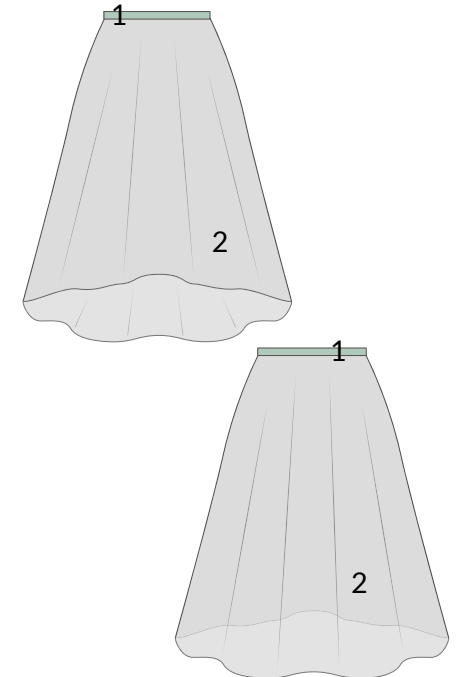



STUDIO SKIRT CA15010

- 1st Fabric (Belt)-Warp knit fabric
- 2nd Fabric (Skirt)

Fabric (2)	Code	Price
Georgette	G	120€
Tulle	TP	170€
Lace	P	200€
DellaLo' Lace	PD	215€
DellaLo' Embroidered tulle	TRD	262€

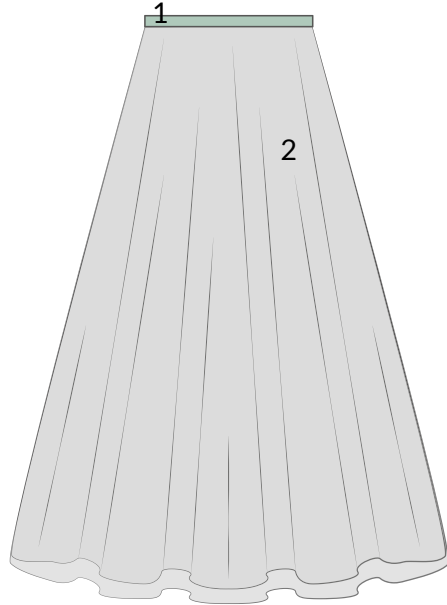

DIANA SKIRT CA15014

- 1st Fabric (Belt)-Warp knit fabric
- 2nd Fabric (Skirt)

Fabric (2)	Code	Price
Georgette	G	55€
Tulle	TP	78€
Lace	P	92€
DellaLo' Lace	PD	99€
DellaLo' Embroidered tulle	TRD	120€

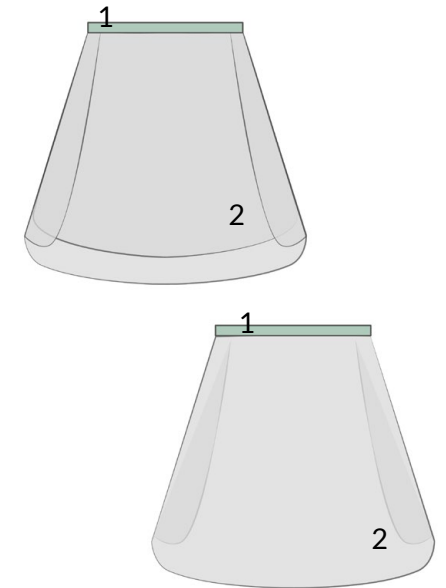



Mr.B SKIRT CA15015

- 1st Fabric (Belt)-Warp knit fabric
- 2nd Fabric (Skirt)

Fabric (2)	Code	Price
Georgette	G	55€
Tulle	TP	78€
Lace	P	92€
DellaLo' Lace	PD	99€
DellaLo' Embroidered tulle	TRD	120€

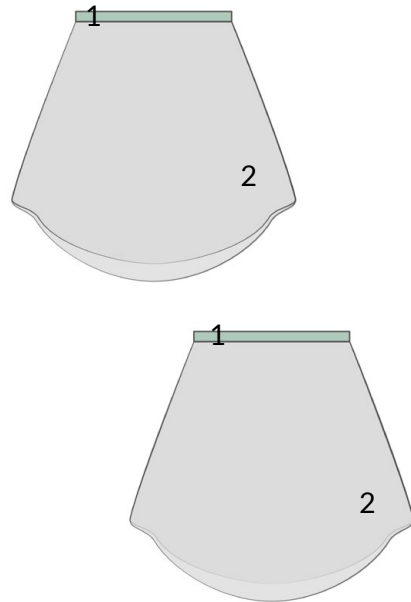

BRIGID Dress CA15016

- 1st Fabric (Top, trimming)-Warp knit fabric
- 2nd Fabric (Skirt)

Fabric (2)	Code	Price
Georgette	G	125€
Tulle	TP	130€
Lace	P	148€
Embroidered Tulle	TR	173€
DellaLo' Lace	PD	179€
DellaLo' Embroidered tulle	TRD	250€

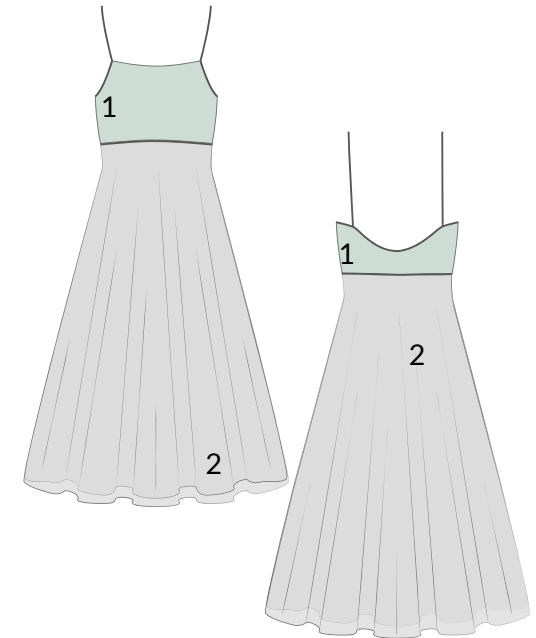



Showroom: DellaLo' Milano, Via Garian, 42 - 20146 Milano (MI), Italy
+39 0246516641 | www.dellalomilano.com | custom@dellalomilano.com