

Skin S70 Suspended Lamp

Designer - AIA Salazar-Navarro

FINISHES

Lamp Finish - Plastic



Opal White

Mesh Finish - Metal



Satin Bronze



Steel

LIGHT SOURCES

LED: 2 X 20.5W

LUMINAIRE FLUX: 7080LM

MILLIAMPERE: 450MA

CRI: ≥90

TEMPERATURE: 3000K

VOLTAGE: 110V

MATERIALS

- Metal

- Plastic

CERTIFICATIONS

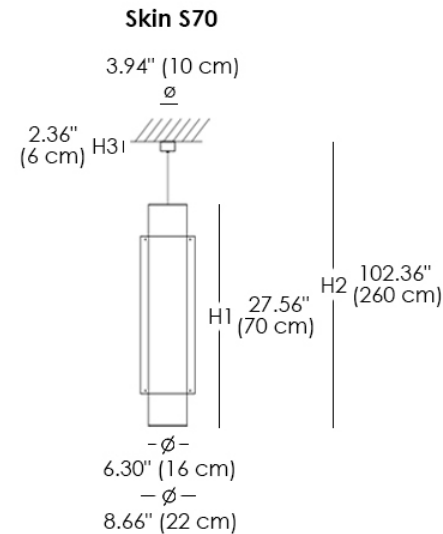

Suspension lamp (S) made out of opal white polymethacrylate, coated in a stainless steel, cylindrical metal mesh, lacquered in steel or satin bronze finishes.

This is a UL Certified Lamp