

Misko C35 Ceiling Lamp

Designer - Stone Designs

FINISHES

Disc Finish - Wood, Metal



Matte Black



Natural Walnut

Diffuser Finish - Glass



Matte White

LIGHT SOURCES

LED: 10W (E26)

Fluo. max: 11W (E26)

CERTIFICATIONS



MATERIALS

- Metal
- Glass
- Wood



Misko C35

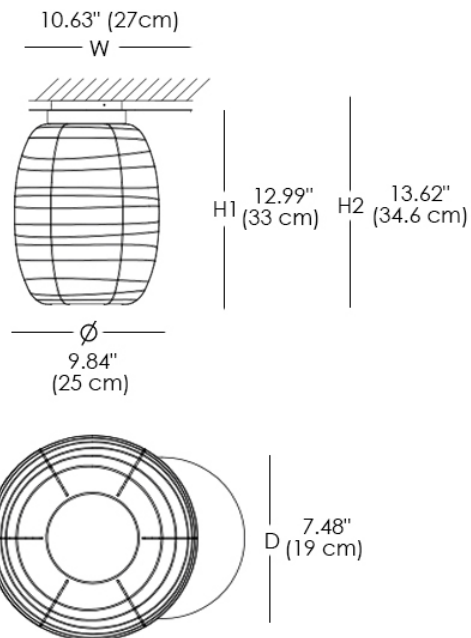

Japanese-style ceiling lamp, available in size (C35). Made with a disc that holds a source of light (E26). This disc can come in natural walnut or painted in matte black and supports the textured blow-glass diffuser with an opal matte white finish. This is a UL Certified lamp.