

PROJECT : _____
SALE : _____

Lampitude

Product



Dimension

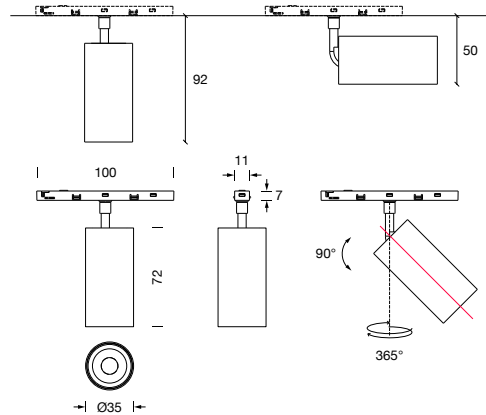

Specification

SERIES : MINI-TRACK
ITEM CODE : MINI-TRACK-35-8W-22D-3000K-BK
DESCRIPTION : MINI TRACK LIGHT
SIZE : Ø35 X H92 (MM)

INSTALLATION : TRACK MOUNTED
DRILL SIZE : -
WEIGHT : 0.11 KG
MATERIAL : ALUMINUM , PC
COLOR : BLACK
REFLECTOR : -
DIFFUSER : -
IP RATING : 20

LIGHT SOURCES : LED COB
SOCKET : -
WATTS : 8W
INPUT VOLTAGE : DC 48V
CCT : 3000K
CRI : >90
BEAM ANGLE : 22°
LUMEN POWER : 472 LM
LIFETIME : 35,000 Hrs

CONTROL GEAR : -
ACCESSORIES : -
REMARKS : TRACK NOT INCLUDED

Head office 299/1 (Ekamai) Klongton-Nua, Wattana, Bangkok Thailand 10110

Tel (02) 392 6371-5 FAX (02) 392 1839 Email info@lamptitude.net www.lamptitude.com

PROJECT : _____
SALE : _____

Lampitude

Accessories

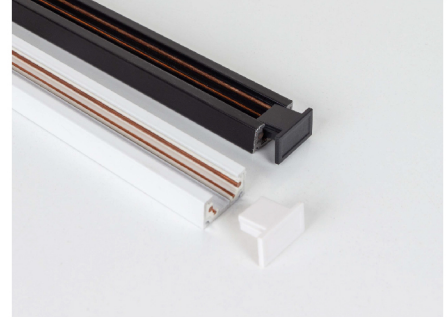
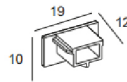
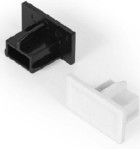

DESCRIPTION END CAP
ITEM CODE MINI-TRACK-END-CP-BK (สีดำ) / MINI-TRACK-END-CAP-WH (สีขาว)
REMARK 2 PCS/ SET (NEED THIS PART)

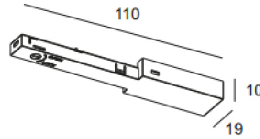

DESCRIPTION ELECTRICAL FEEDER PART
ITEM CODE MINI-TRACK-FEEDER-BK (สีดำ) / MINI-TRACK-FEEDER-WH (สีขาว)
REMARK WITH 45 CM. CABLE (NEED THIS PART)

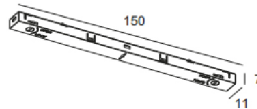

DESCRIPTION LINEAR TRACK CONNECTOR
ITEM CODE MINI-TRACK-I-LINEAR-BK (สีดำ) / MINI-TRACK-I-LINEAR-WH (สีขาว)
REMARK NEED FOR STRAIGHT CONNECT

Head office 299/1 (Ekamai) Klongton-Nua, Wattana, Bangkok Thailand 10110

Tel (02) 392 6371-5 FAX (02) 392 1839 Email info@lamplitude.net www.lamplitude.com

PROJECT : _____

SALE : _____

Lampitude

Accessories

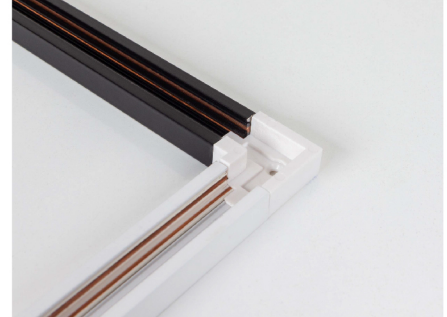
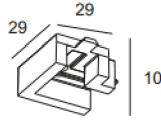
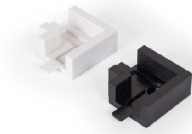

DESCRIPTION L CONNECTOR FIXING PART
ITEM CODE MINI-TRACK-L-CONNECTOR-BK (สีดำ) / MINI-TRACK-L-CONNECTOR-WH (สีขาว)
REMARK USE WITH MINI-TRACK-L-LINEAR

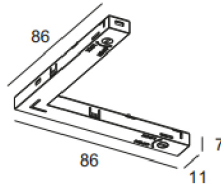
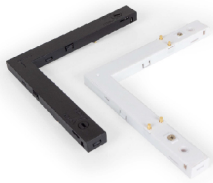

DESCRIPTION L CONNECTOR
ITEM CODE MINI-TRACK-L-LINEAR-BK (สีดำ) / MINI-TRACK-L-LINEAR-WH (สีขาว)
REMARK USE WITH MINI-TRACK-L-CONNECTOR

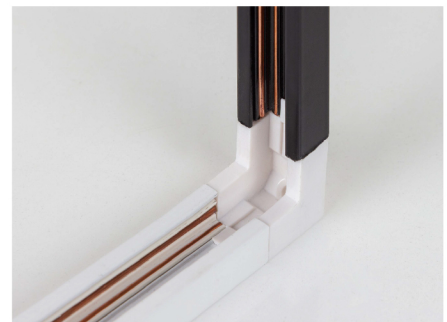
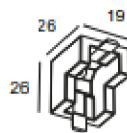
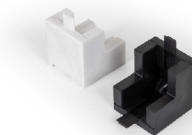

DESCRIPTION VERTICAL CORNER CONNECTOR FIXING PART
ITEM CODE MINI-TRACK-V-CONNECTOR-BK (สีดำ) / MINI-TRACK-V-CONNECTOR-WH (สีขาว)
REMARK USE WITH MINI-TRACK-V-LINEAR

Head office 299/1 (Ekamai) Klongton-Nua, Wattana, Bangkok Thailand 10110

Tel (02) 392 6371-5 FAX (02) 392 1839 Email info@lamptitude.net www.lamptitude.com

PROJECT : _____
 SALE : _____



Accessories

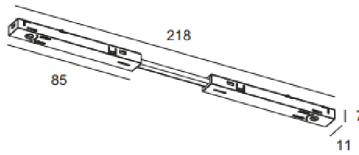

DESCRIPTION L CONNECTOR FIXING PART
ITEM CODE MINI-TRACK-L-CONNECTOR-BK (สีดำ) / MINI-TRACK-L-CONNECTOR-WH (สีขาว)
REMARK USE WITH MINI-TRACK-L-LINEAR

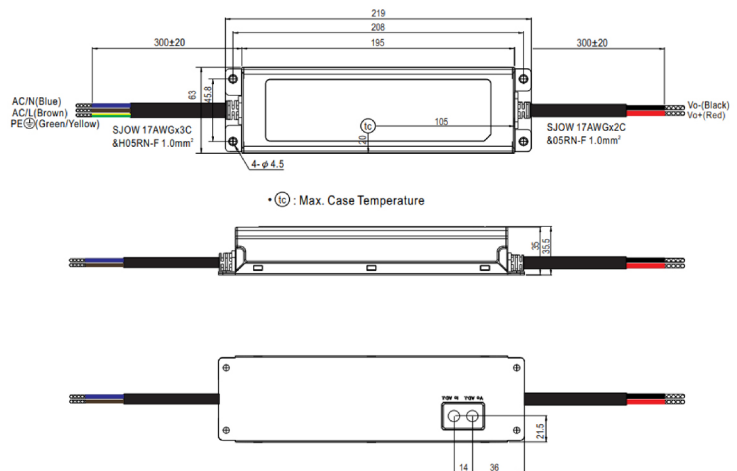

DESCRIPTION POWER SUPPLY
ITEM CODE CGPS-ELG-150W-48A-MW
WEIGHT 0.95 KG
MATERIAL METAL
IP RATING IP65
RATED POWER MAX 150W
POWER FACTOR (PF) 0.9

HARMONIC (THD) <20%
INPUT VOLTAGE AC 100-305V , 47-63 Hz
OUTPUT VOLTAGE DC 48V
OUTPUT CURRENT 3.13A
AMBIENT TEMPERATURE 40°C to 55°C
LIFE TIME 35,000 - 50,000 Hrs